



 JURALCO

# JURALCO RETRACTABLE PLEATED VENETTE™ INSECT SCREEN SYSTEMS

ISSUE 4-24 v1

## Juralco Venette™ Retractable Pleated Insect Screen Systems

Juralco Aluminium Building Products Ltd designs and distributes specialist aluminium joinery systems through a national network of franchised fabricators and agents. For more than 25 years we have been at the forefront of specialist aluminium door and window products suitable for New Zealand joinery and building methods. Our comprehensive product range includes security and insect screens, balustrades and gates, shutters and awnings, shower screens, wardrobe doors and organisers and internal doors.

Juralco Sheer Retractable Pleated Insect Screens are suitable for Window or Door openings. The Doors have low profile tracks to guide and retain the mesh making the Juralco retractable pleated insect screens the ultimate in insect screening solutions. Custom made in a variety of powder-coat colours.

### Index

Pages	Covers	Section 1 - Venette™ Retractable Pleated Insect Screen - Single + Multiple Doors
3 - 4	General	Showing typical component layouts
5 - 7	Materials	All Extrusions and Components
8 - 9	Layouts	One to Six Door Layouts
10	Build Out	Shows construction of a Build out Frame
11 - 14	Installation	Detailed step by step by guide to cut, install and adjust
15	Cleaning	Instructions for Cleaning a Venette screen - Applies to all Pleated Screens
16	Order Form	Juralco Order Form - Venette Doors
<b>Section 2 - Venette™ Retractable Pleated Insect Screen - Vertical Window</b>		
17 - 18	General	Showing typical component layouts
19 - 20	Materials	All Extrusions and Components
21 - 22	Installation	Detailed Installation instructions
23	Order Form	Juralco Order Form - Venette Vertical Windows
<b>Section 3 - Venette™ Retractable Pleated Insect Screen - Horizontal Window</b>		
24	General	Showing typical component layouts
25 - 26	Materials	All Extrusions and Components
27 - 28	Installation	Detailed Installation instructions
29	Order Form	Juralco Order Form - Venette Horizontal Windows
30	PC Care	Care of Powder Coated surfaces

#### Important information - Powder Coating systems.

**Powdercoat Systems** The new standard Dulux powder coating system used by Juralco is Duralloy Plus®. Also Duralloy® and Duratec®. Juralco Powder coated prices are for Duralloy Plus® and Duralloy® (same pricing). Duratec® prices on application. The following specs apply to Building Exteriors.

- Dulux Duralloy Plus® powder coating systems are suitable for properties greater than 10m from high tide level. Residential and Light commercial buildings, 3 levels max. Warranty 15 yrs
- Dulux Duratec® powder coating systems are suitable for properties greater than 10m from high tide level. All Residential and Commercial buildings. Warranty 25 yrs.

**Attachment to structures** A PVC Tape or similar material spacer must be used to separate powder coated aluminium items from all concrete and steel structures. Failure to do so can lead to the chemicals in the structure affecting the powder coating, leading to corrosion.

**Swimming Pools** The chlorinated water in swimming pools can cause the deterioration of powder coated surfaces, leading to corrosion of the underlying surface. It is recommended that Powder coated surfaces be 1200mm min from a pool.

**Care** The Dulux powder coating warranty period is conditional upon the surface being maintained in accordance with the Dulux 'Care and Maintenance Instructions'. Download from Dulux or refer to the back page of this manual.

Juralco will supply the Pleated Mesh Pack all fully assembled as enclosed below.  
 Also included are 1 x Top guide and 1 x U Profile  
 All cut to length and Powdercoated to a colour of your choice.  
 Supplied loose are the 2 x Top Guide End Caps and Clips

- 1 Pleated Mesh
- 2 Setting Plate
- 3 Right Cord Guide
- 4 Central Cord Guide
- 5 Left Cord Guide
- 6 Adjust Height Tail White
- 7 Tail End
- 8 Scorpion Tail
- 9 Tail Reversal
- 10 Cord End Tail Yellow
- 11 Cord End Tail Red
- 12 Screw 3X10
- 13 Top Cap Sliding Bar
- 14 Top Cap Wall Profile
- 15 Screw 3X30
- 16 Top End Cap Sliding Bar
- 17 Top End Cap Wall Profile
- 18 Bottom End Cap Sliding Bar
- 19 Bottom End Cap Wall Profile
- 20 Top Guide Cap
- 21 Clip
- 22 Handle
- 23 Positive Magnet
- 24 Negative Magnet
- 25 PVC for Magnet
- 26 U Profile
- 27 Top Guide
- 28 Wall Profile
- 29 Sliding Bar
- 30 PVC Bottom Guide

**Fully assembled Mesh Pack**

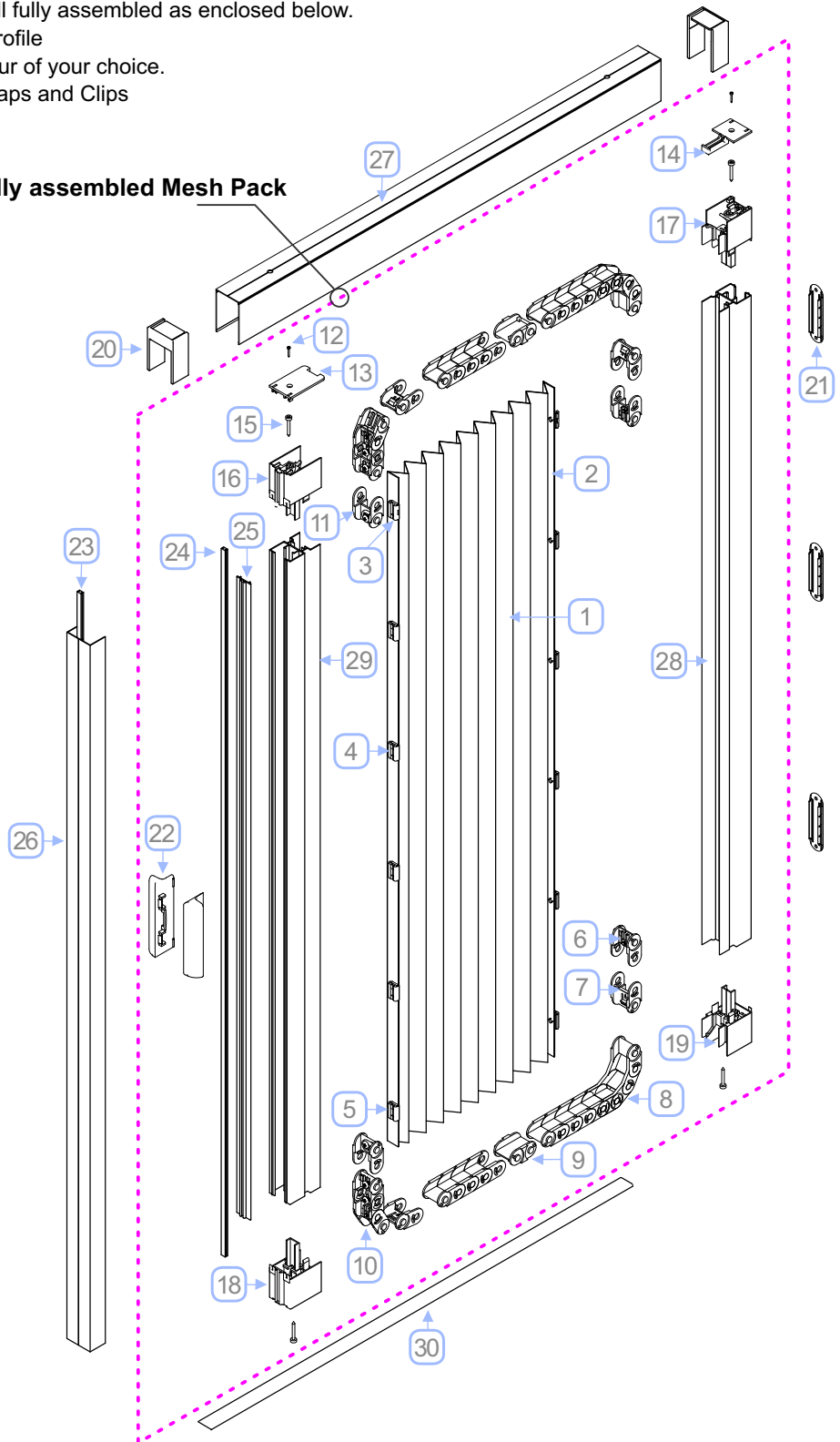

**Profile Sections**

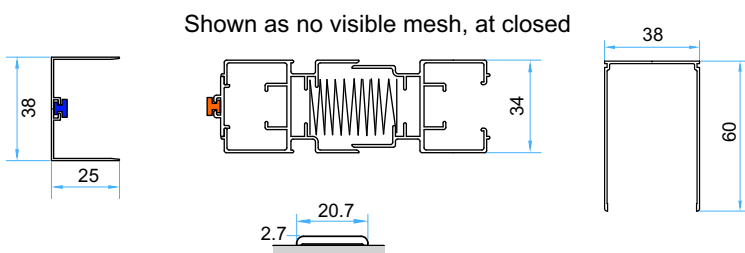

**Opening Options**

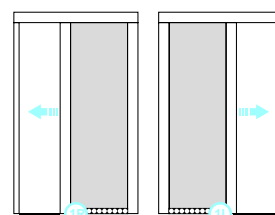

**Max Dimensions**

Height 3000 max  
 Width 500 min  
 1250 max  
 (No mesh showing)  
 Width 1500 max  
 (Mesh shows)

Single Panel Shown, but up to 2x3 Linked Doors possible



**Juralco Venette™ Retractable Pleated Insect Screens**  
**Single Door - General Layout for over 1500mm wide**  
**or 800mm wide in a High Wind area.**

**Section 1**  
**Doors**

Juralco will supply the Pleated Mesh Pack all fully Assembled.  
 incorporating the extra Items below.

- 31 Rivet
- 32 Intermediate Scorpion Tail
- 33 Tube
- 34 Joint for Tube

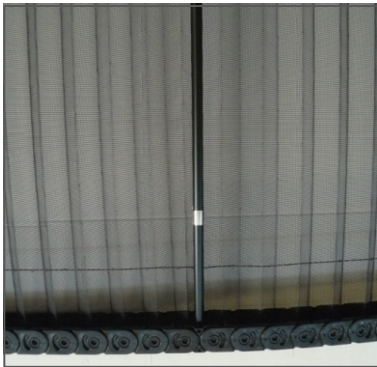
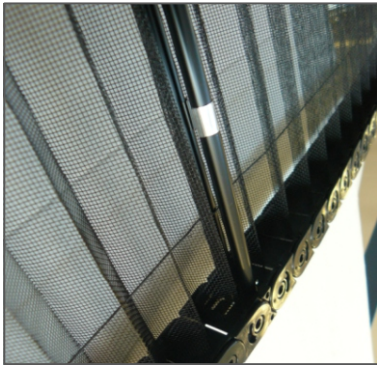

**Fully assembled Mesh Pack**

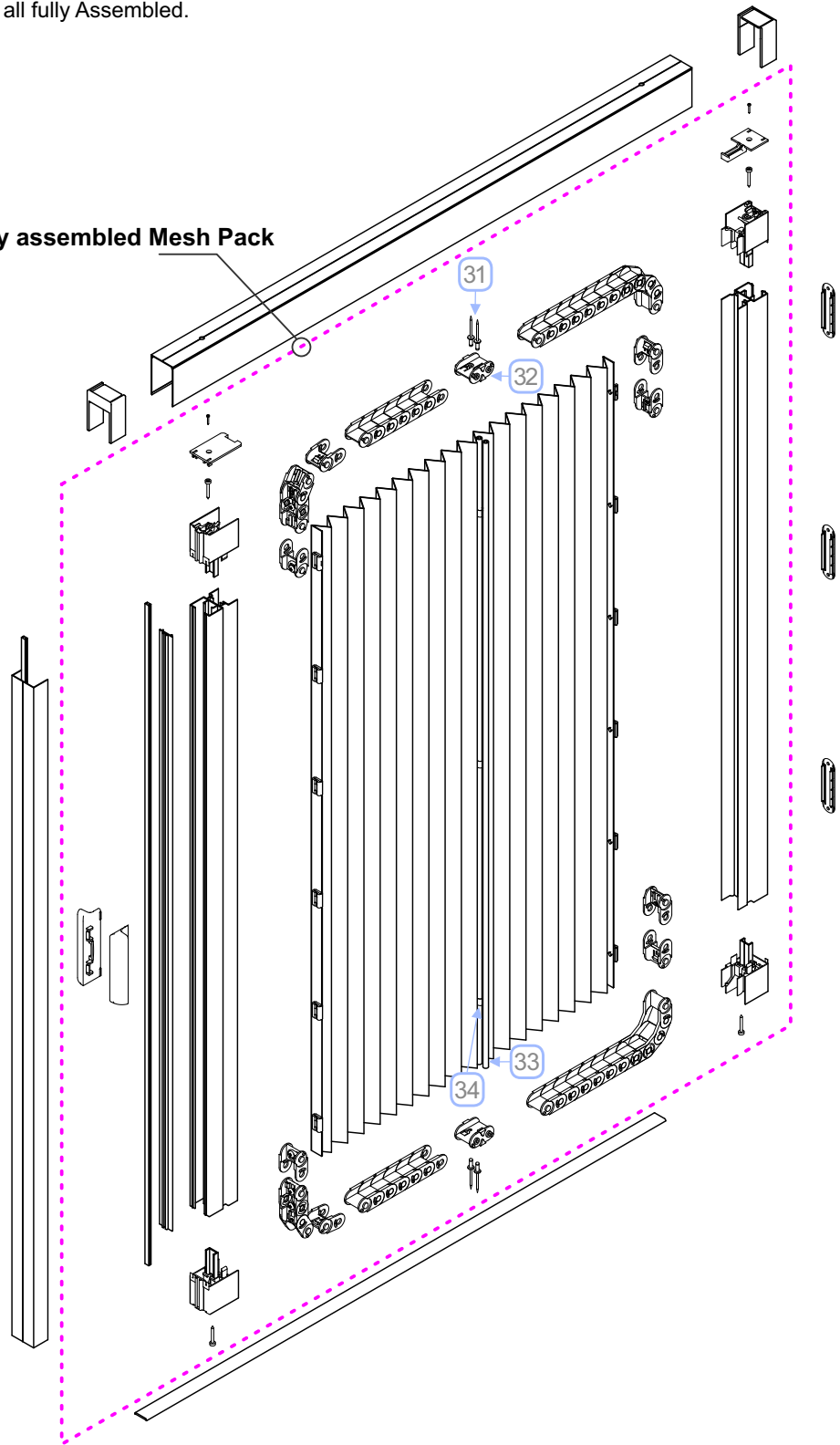

**Profile Sections**

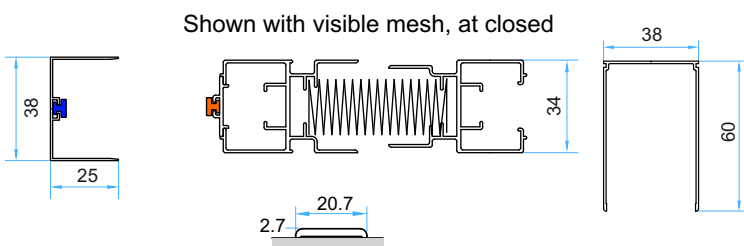

**Opening Options**

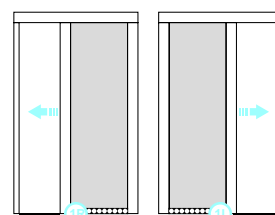

**Max Dimensions**

Height 3000 max  
 Width 2000 max  
 (Central Tubes and  
 Mesh show)

Single Panel Shown, but up to 2x3 Linked Doors possible

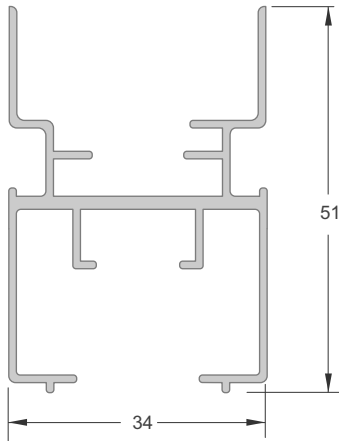

**SLIDING PROFILE**  
 Part No JPL/05/00012

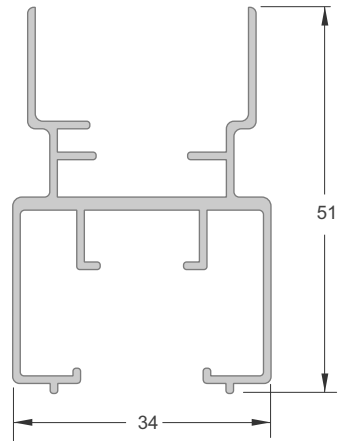

**WALL PROFILE**  
 Part No JPL/05/00002

**Mesh Pack Vertical Sides**



**BUILD OUT COVER**  
 Part No J7469

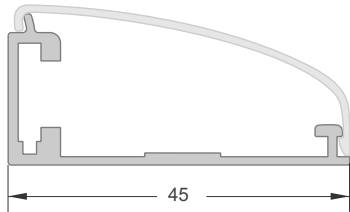

**BUILD OUT ANGLE**  
 Part No J7468

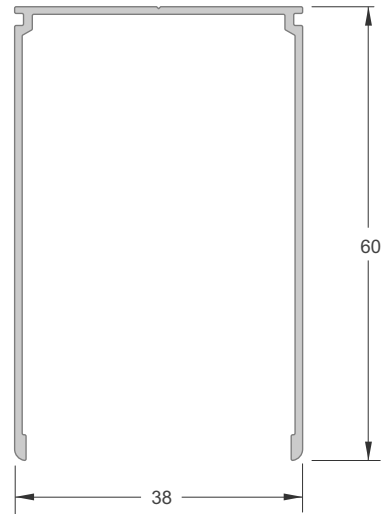

**TOP GUIDE 5.8m**  
 Part No JPL/05/00020

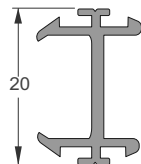

**TRAIN CONNECTOR PVC STRIP**  
 Part No JPL/05/00100/0/5

Used to connect cassettes together  
 in multiple cassette applications

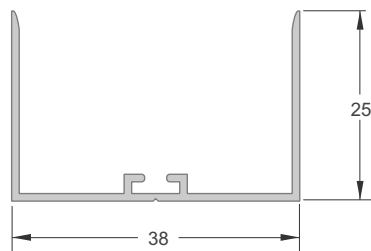

**U PROFILE**  
 Part No JPL/05/00080

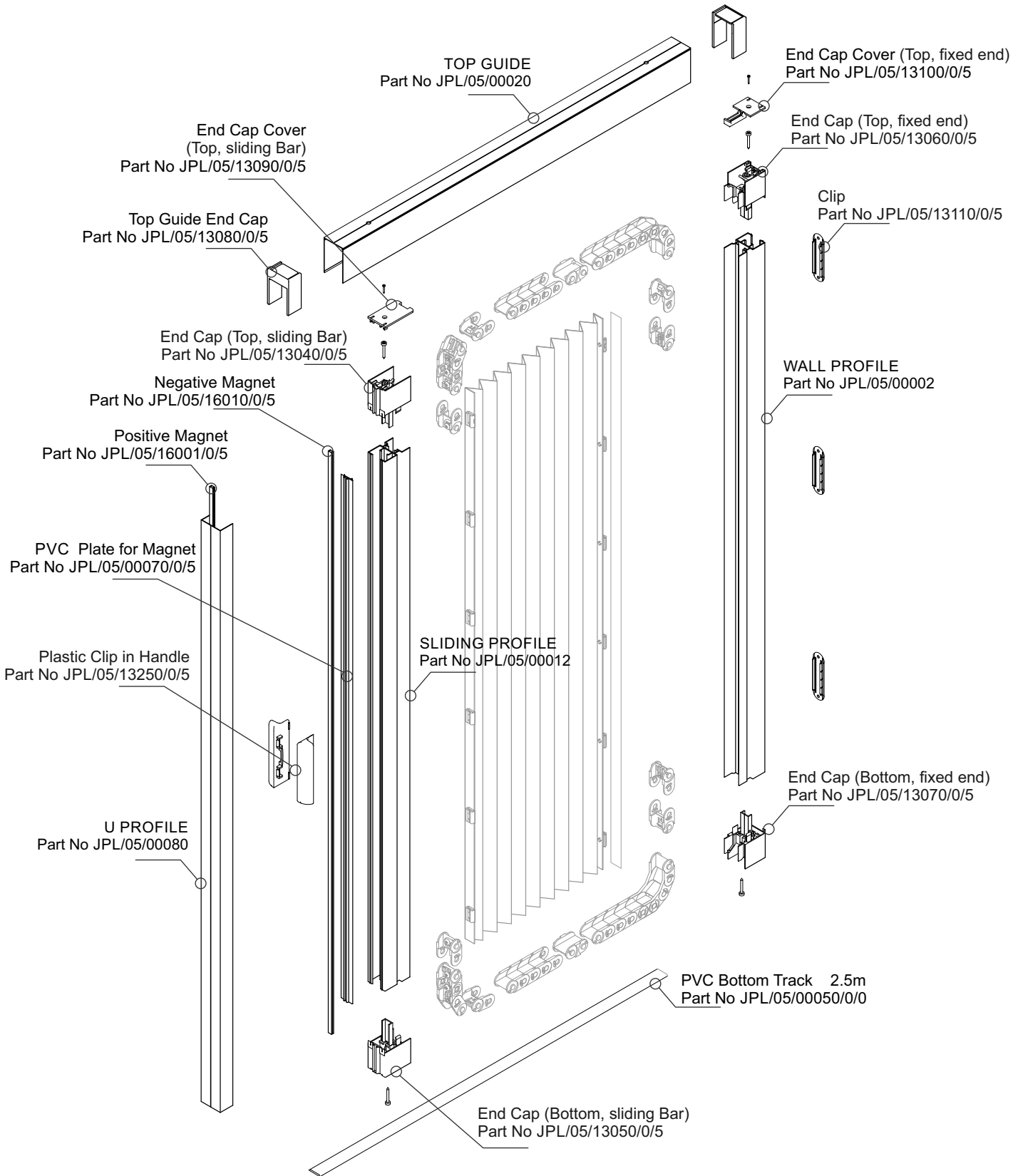

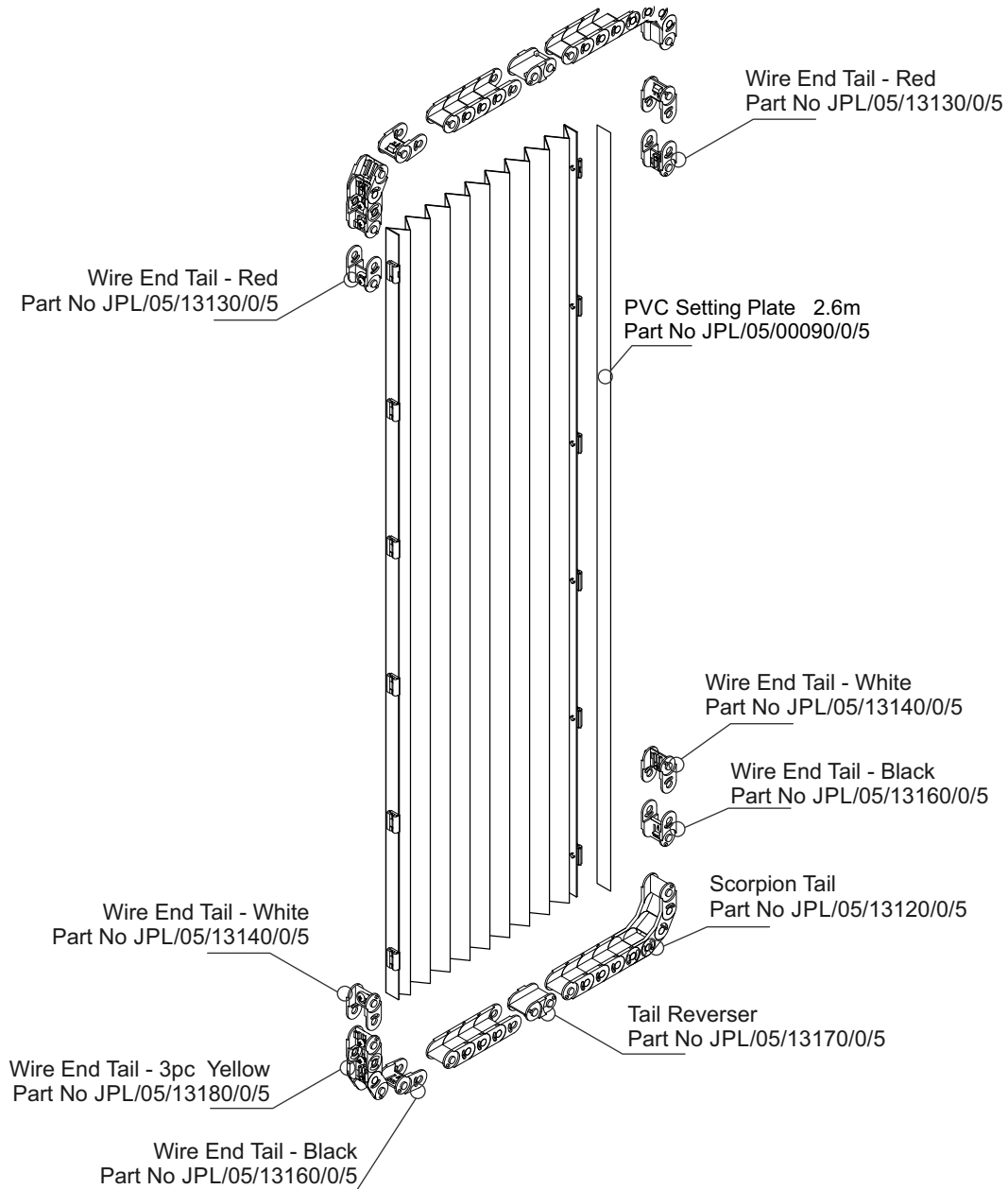

**Build Out Frame. Extrusions, Components**

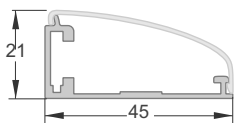

**BUILD OUT ANGLE**  
Part No J7468

Powder coated

**BUILD OUT COVER**  
Part No J7469

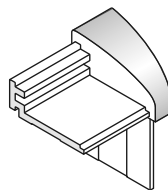

**Corner Stake for Build Out**  
Part No JC298

Black only

**Wire**  
Part No JPL/05/13000/0/5



Maximum Prefinished Mesh Pack Height and Width Dimensions

- Height, max opening 3000mm
- Width, Single Door, Expanded max 1250mm.
- Width, Single Door, Expanded max 1500mm. Mesh shows at compressed position
- Width, Single Door + Central Supports, Expanded max 2000mm. Mesh shows at compressed position
- The Height must be a min of 300mm greater than the Width of the Opening
- Doors over 1500mm wide or 1000mm wide installed in High Wind Zones will need extra central supports

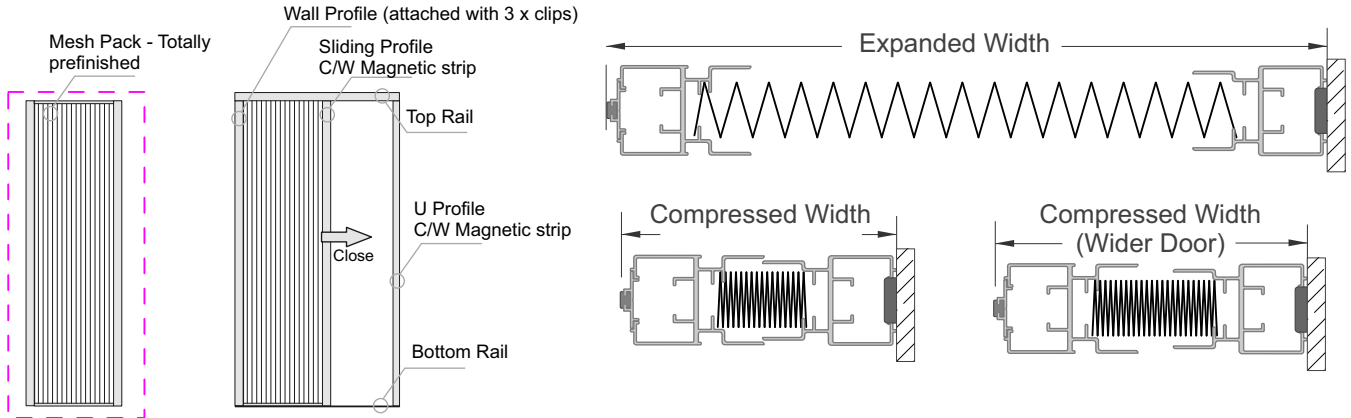

**ALL CONFIGURATIONS ARE REVERSIBLE RH/LH. INSTALLATION REVEAL or FACE FIX (with a Build out frame)**

**1E Single Door Configurations**

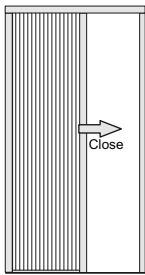

Single Panel  
End Close  
  
Installation  
can be reversed  
for RH or LH  
operation  
  
Height up to 3000max  
Door Open widths  
500min to 2000max

**2E Two Door Configurations**

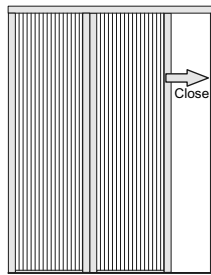

Two Panels  
End close  
  
Installation  
can be reversed  
for RH or LH  
operation.  
  
For both  
Height up to 3000max  
Door Open widths  
1000min to 4000max

**2C**

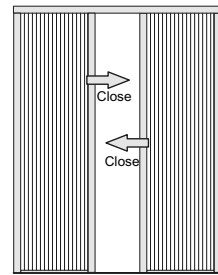

Two Panels  
Centre close

**3E Three Door Configurations**

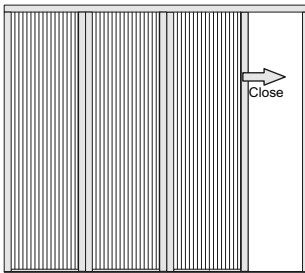

Three Panels  
End Close  
  
Installation  
can be reversed  
for RH or LH  
operation  
  
For both  
Height up to 3000max  
Door Open Widths  
1500min to 5550max

**3C**

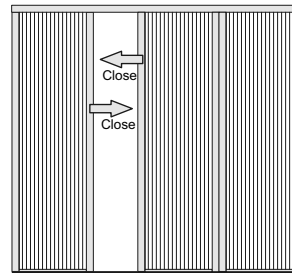

Three Panels  
Centre Close  
  
Installation  
can be reversed  
for RH or LH  
2/1 combo  
operation

**4C Four Door Configurations**

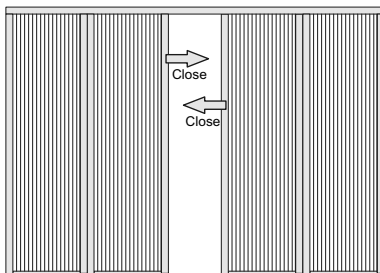

Four Panels Centre Close

**4C1**

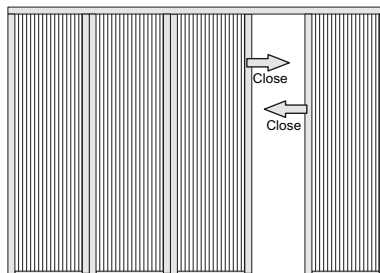

Four Panels Centre Close  
Installation can be reversed  
for RH or LH3/1 combo operation

**4E**

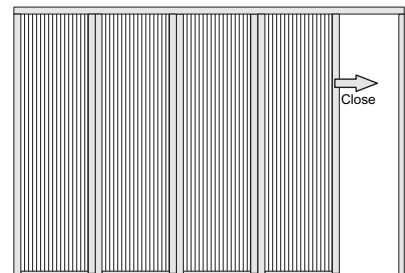

Four Panels End Close  
Installation can be reversed RH/LH

For all Height up to 3000max, Door Open Widths 2000min to 5800max



**ALL CONFIGURATIONS ARE REVERSIBLE RH/LH. INSTALLATION REVEAL or FACE FIX (with a Build out frame)**

**Five Door Configurations 5C**

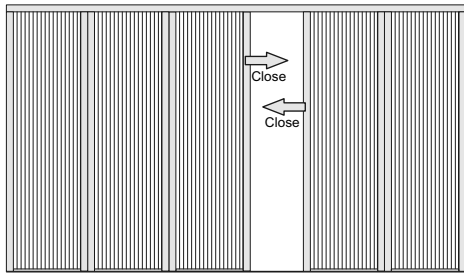

Five Panels  
Centre Close

Installation  
can be reversed  
for RH or LH  
3/2 combo  
operation

**5C** FivePanels  
End Latched  
OH up to 3000max  
Door OW  
2500min to 97000max

**Six Door Configurations 6C**

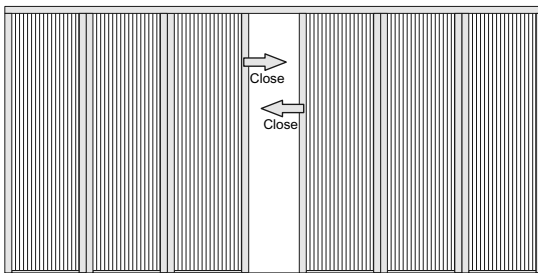

Six Panels  
Centre close

**6C** Six Panels  
Centre Latched  
OH up to 3000max  
Door OW  
3000min to 11600max

**Multiple Door Connections**

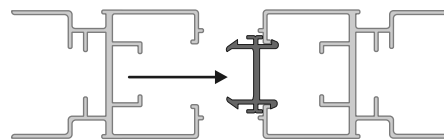
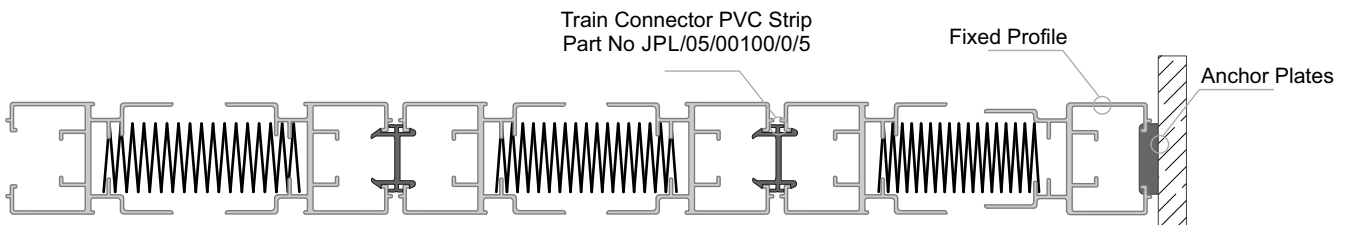

Then Clip on to  
this section.

Clip on to this section  
to begin with.

**General Assembly for a Face Fix Installation  
using the Build Out Angle and Cover  
together with the Corner Stake x 4 Sides**

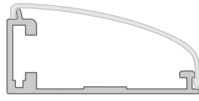

Build out angle  
Part No J 7468



Build out cover  
Part No J 7469

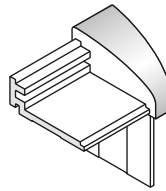

Corner Stake for Build Out  
Part No JC 298

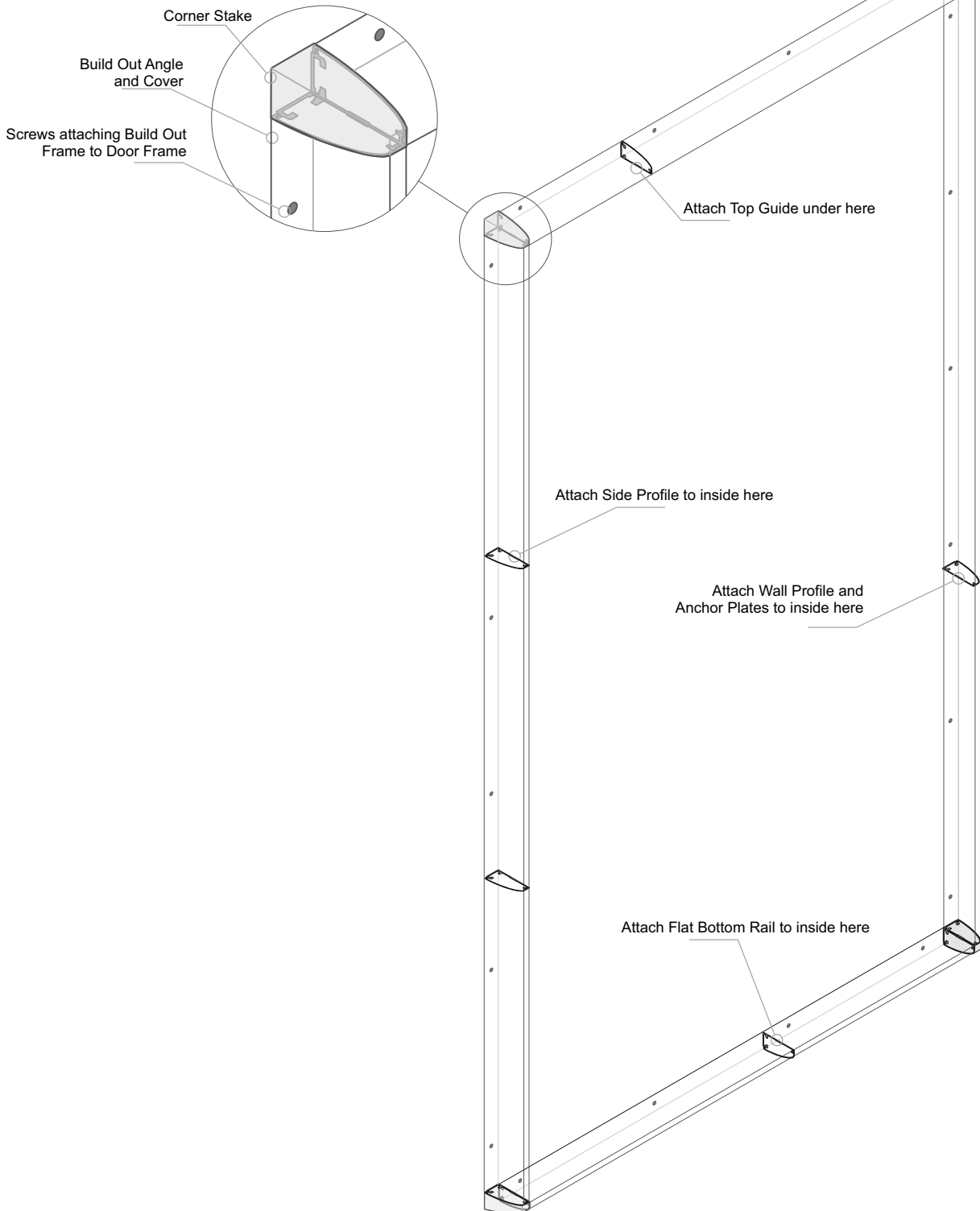

To watch this Installation video,  
click or enter the link below  
<https://youtu.be/uBJ5814ldxo>

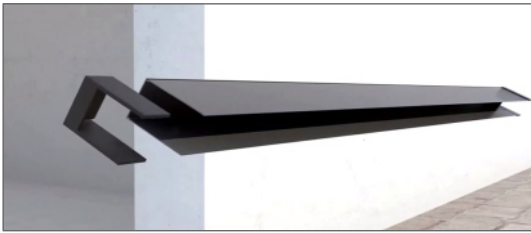

1 - Top Guide, attach both End Caps

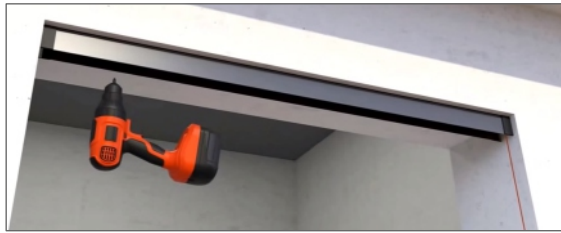

2 - Attach Top Guide to the Ceiling, with suitable SS fasteners. Pack if necessary; must be no greater than 10mm out of parallel to floor.



3 - Attach Clips to the Wall with suitable SS fasteners

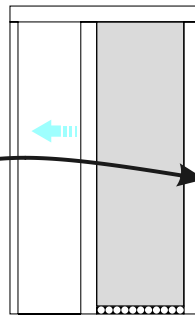

4 - Insert the U Profile (with Magnet) into the Top Guide



5 - Attach the U profile to Wall with suitable SS fasteners. (to ea side of Magnet)



6 - After cleaning the floor area, attach Bottom Rail to the Floor with attached DS tape



7 - Insert Mesh pack into the Top Guide. Then push Mesh Pack firmly onto the Clips. 'Clicks' If multiple doors insert the Train connector strip(s) first to join Doors together.



8 - Test for Smooth operation. Test Magnet closing satisfactory

**MULTIPLE SCREEN PANEL SYSTEMS**

Please note that all screens use a full length magnetic seal.  
Panels can be reversed to operate left or right.

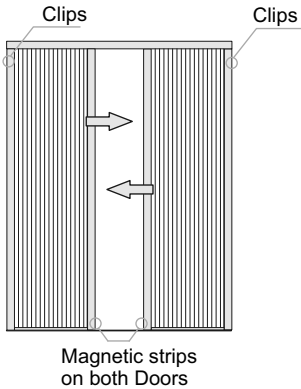

**Centre Close Multiple Panel Screens**  
Note that these configurations do not use a U profile but instead uses Mesh Packs with one being installed at each side jamb of the door opening. Install three Clips at each side jamb. Add additional screws when installing the Top guide. Locate the Mesh Packs with full length magnetic strips towards each other. Insert the Train connector strip to join Doors together.

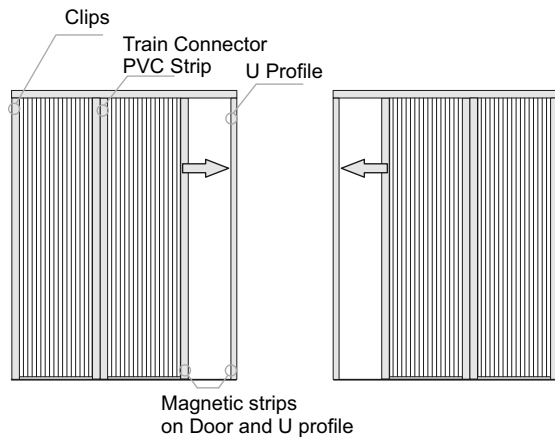
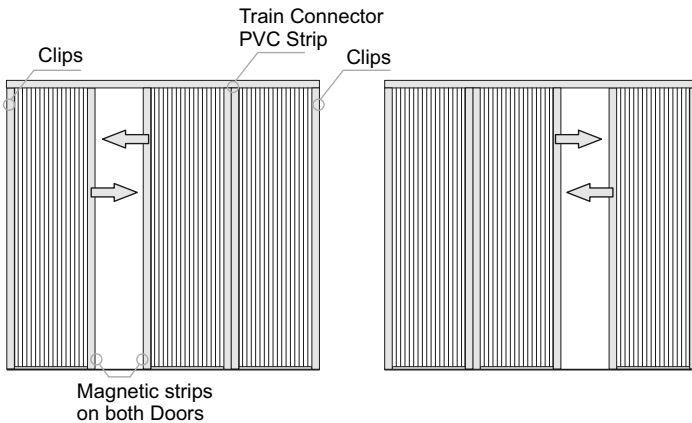

**Side Close Single or Multiple Panel Screens**  
This configuration does use a U profile complete with Magnetic strip. Install three Clips at one side jamb. Add additional screws when installing the Top guide. Locate the Mesh pack with full length magnetic strip towards the U Profile. Insert the Train connector strip to join 2 x Doors together.

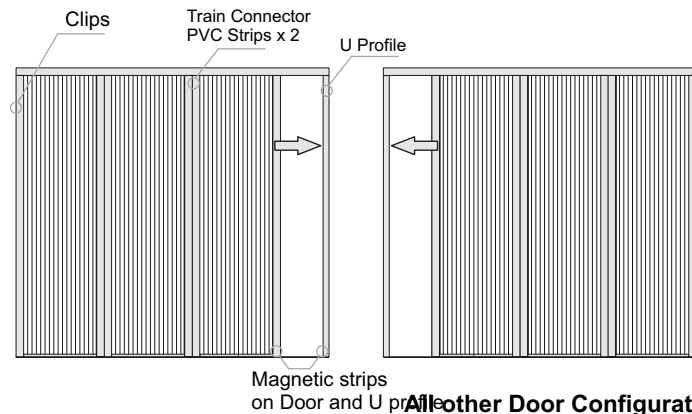

**All other Door Configurations are variations of above**

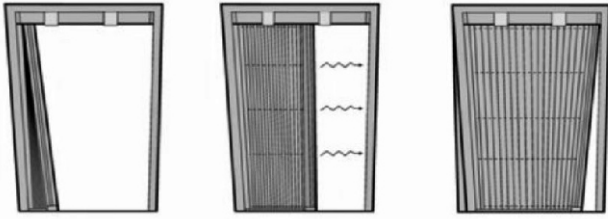

- Problems -
- 1 - The Sliding Door is tilted and does not move smoothly.
  - 2 - The sliding bar and stile post are not parallel and the pleated screen does not fold properly
  - 3 - There is a gap between the sliding Door and the Door stop

Solution - Adjustments as below

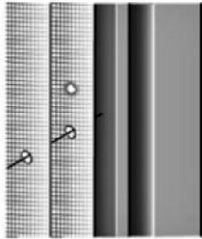

- Problems -
- 1 - Wire damage - accidentally cut or damaged
  - 2 - Screen damage - accidentally cut or damaged

Solution -  
 Wires damaged - Replace the Screen  
 Screen damaged - If small, patches are available.  
 If large, replace Screen

Due to the products configuration the pleated screen cannot be replaced by itself. The entire screen door must be replaced. Juralco can supply replacement Mesh packs

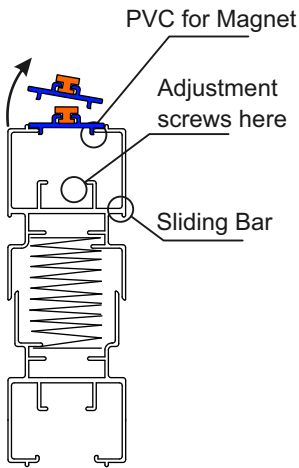

**SLIDING BAR INCLINATION ADJUSTMENT**

The screw that adjusts the sliding bar inclination is located on the inside of the sliding bar itself.

Remove the PVC for Magnet by inserting a screwdriver into the gap between the PVC and sliding bar. Remove the PVC strip by lifting it out. THIS MUST BE DONE FROM THE CENTRE OUT TO TOP AND BOTTOM. If not you will break the Magnet.

Adjustment screws are now exposed

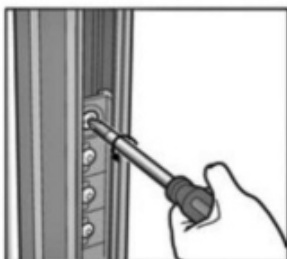
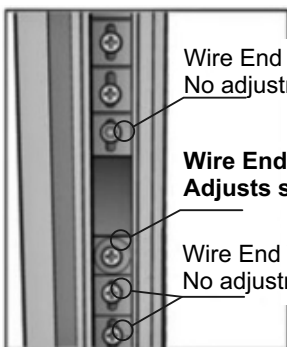

Adjust the inclination of Sliding Bar  
 Loosen the White screw.  
 Note - There is a nut on the other side of the screw do not loosen too far - just far enough.

**Sliding Bar Inclination Adjustment,**  
**continues next page**



**SLIDING BAR INCLINATION ADJUSTMENT, CONTINUED**

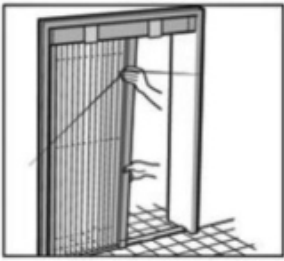

Straighten the Sliding Bar

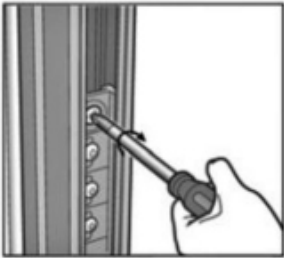

After straightening the Sliding Bar  
 Tighten the White screw. Note - Do not overtighten.  
 Do not use electric screwdrivers.  
 After adjusting be sure to check the tension  
 of all the wires running through the  
 pleated screen. See Wire adjustment.  
 Slide the Screen back and forth to check smooth operation  
 and readjust if necessary.

**WIRE ADJUSTMENTS**



If the wires running through the Pleated Screen  
 are too taut or too loose, the screen door will be  
 too difficult (or too easy) to open or close.  
 Ideally the wires should be firm but under no tension.  
 To check wire tension insert the tip of a screwdriver  
 under the wire and pull gently.  
 Adjust each section of wire so it is neither too taut or too slack.

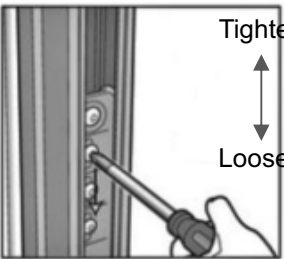

Loosen the screw, Wire end tail (yellow).  
 Slide up or down.  
 Tighten, nip up only.  
 Do not overtighten.

Move the sliding bar left/right  
 making sure the screen door  
 moves easily. If not re-adjust

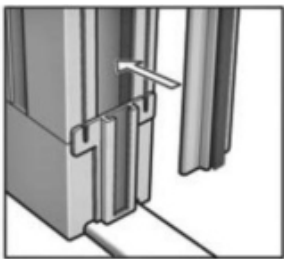

Replace the PVC and Magnet

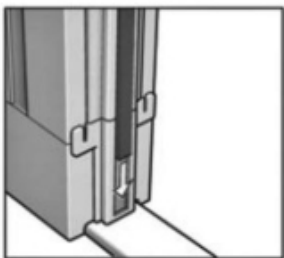

Slide the magnet down to insert the end into the  
 groove on the scorpionfish, Top and Bottom  
 Moving from bottom to top press the PVC for Magnet  
 into the sliding bar

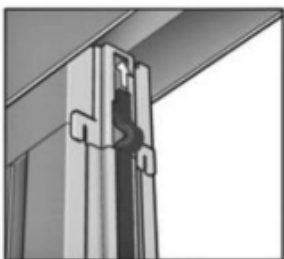

**Wire Configuration**

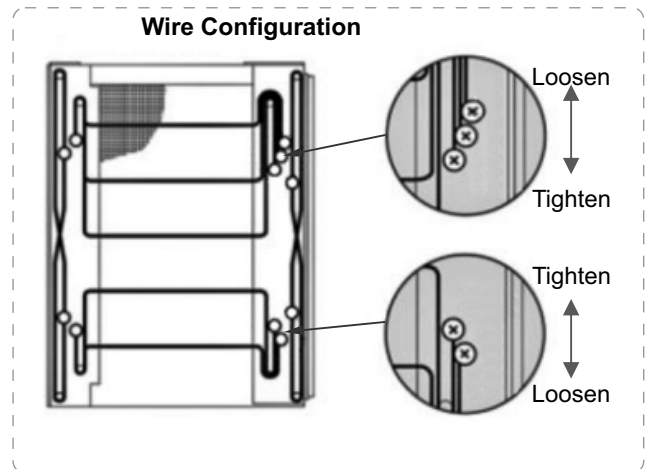

**CLEANING**

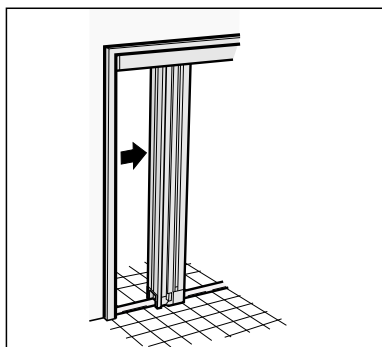

**1. Remove the Screen Door Unit**  
 The Screen Door Unit can be removed easily and rinsed when it is dirty. Use a soft brush or the like to clean the pleated net and the Scorpion Tail. Hold the Sliding Profile (at bottom or top) With both hands and pull out the Screen Door Unit from the doorframe. Tilt the Screen Door Unit and remove from the Top Guide

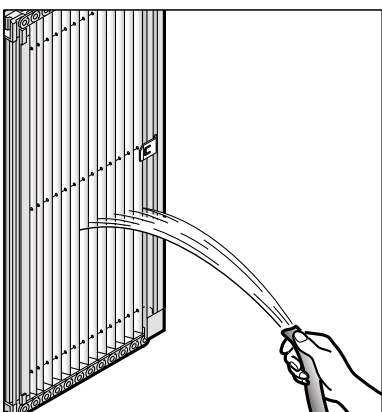
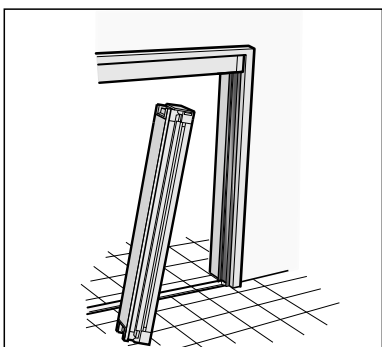

**2. Rinse the Screen Door Unit**  
 Pull the Screen Door Unit out so it is fully extended and place it upright against something. Rinse the Screen Door Unit and clean with a soft brush. Do not damage the pleated net or wires. If the Screen Door Unit is very dirty, use a mild household detergent, Never use paint thinner, benzene or other organic solvents.

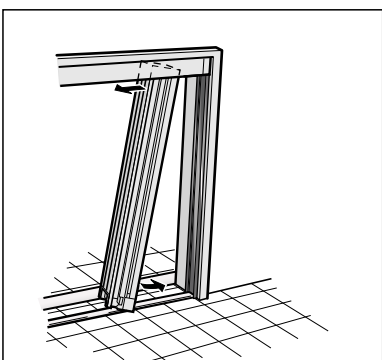

**3. Dry the Screen Door Unit**  
 After rinsing the Screen Door Unit, dry all parts thoroughly. Replacing the Screen Door Unit wet may affect open/close operation, and make it easier to catch sand and dirt.

**4. Re-attach the Screen Door Unit**  
 Close the Screen Door Unit. Make sure the top Scorpion Tail retracts properly. Make sure the Screen Door Unit is not upside down.

Tit the Screen Door Unit and insert into the Top Guide, and onto the PVC Bottom Track Check the Screen Door Unit does not come off of rail and press firmly towards the door installation frame making sure the Clips fasten in place with an audible "click"

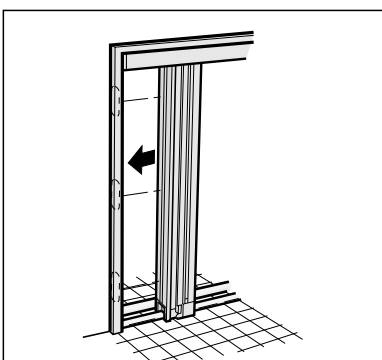

**5. After re-attaching the Screen Door Unit, pull the Sliding Profile to confirm the Screen Door Unit is properly installed. Check the Scorpion Tail retracts properly and does not come apart. In case the Scorpion Tail comes apart, it can be easily reconnected.**

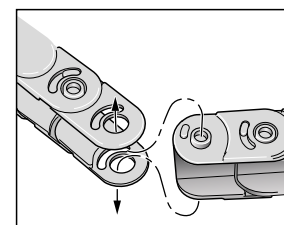

**Juralco Venette™ Retractable Pleated Insect Screens - Doors - Order Form**

Customer		Date	
<b>Venette Pleated DOORS</b>	Order No		Contact
	<b>WO</b> Juralco	<b>BR</b> Juralco	<b>SO</b> Juralco      \$ Juralco

Enter Dimensions. Enter Door Code Choose Finish Then scan and send to [sales@juralco.co.nz](mailto:sales@juralco.co.nz)

**1** Enter Sizes, tick/select types and options  Check

<b>High Wind Zone</b>	Yes	No

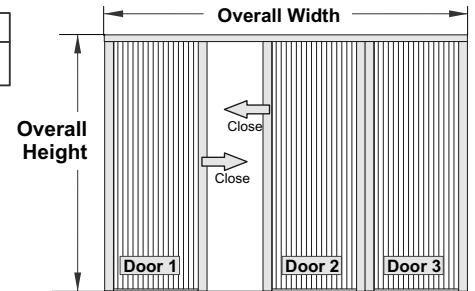

Door Numbering always Left to Right.  
Always Viewed from Outside

- Maximum Prefinished Cassette Height and Width Dimensions
- Height, max opening 3000mm
  - Width, Single Door, Expanded max 1250mm.
  - Width, Single Door, Expanded max 1500mm. Mesh shows at compressed position
  - Width, Single Door + Central Supports, Expanded max 2000mm.  
Mesh shows at compressed position
  - The Height must be a min of 300mm greater than the Width of the Opening
  - Doors over 1500mm wide, or 1000mm wide if installed in High Wind Zones will need extra central supports

**This Order for Venette Pleated Doors**

Enter, Overall Height and Width mm		Door Code	Door Widths Expanded						No identical
			Door 1	Door 2	Door 3	Door 4	Door 5	Door 6	
<b>Unit 1</b>	Height								
	Width								
<b>Unit 2</b>	Height								
	Width								
<b>Unit 3</b>	Height								
	Width								
<b>Unit 4</b>	Height								
	Width								
<b>Unit 5</b>	Height								
	Width								

**6C** Six Panels  
Centre Latched  
OH up to 3000max  
Door OW  
3000min to 11600max

**5C** Five Panels  
End Latched  
OH up to 3000max  
Door OW  
2500min to 97000max

- |   |  |   |  |  |  |   |   |
|---|--|---|--|--|--|---|---|
| <b>1E</b> Single Panel<br>End latched<br>OH up to 3000max<br>Door OW<br>500min to 2000max | <b>2E</b> Two Panels<br>End latched<br>OH up to 3000max<br>Door OW<br>1000min to 4000max | <b>2C</b> Two Panels<br>Centre latched<br>OH up to 3000max<br>Door OW<br>1000min to 4000max | <b>3E</b> Three Panels<br>End latched<br>OH up to 3000max<br>Door OW<br>1500min to 5550max | <b>3C</b> Three Panels<br>End latched<br>OH up to 3000max<br>Door OW<br>1500min to 5550max | <b>4C</b> Four Panels<br>Centre latched<br>OH up to 3000max<br>Door OW<br>2000min to 5800max | <b>4C1</b> Four Panels<br>Centre latched 3/1 Combo<br>OH up to 3000max<br>Door OW<br>2000min to 5800max | <b>4E</b> Four Panels<br>End Latched<br>OH up to 3000max<br>Door OW<br>2000min to 5800max |
|---|--|---|--|--|--|---|---|

**2** Enter Buildouts if Required  Check

Build out + Cover @ 2.9m. <small>J7468/2.9 +J7469/2.9</small>	Build out + Cover @ 5.8m. <small>J7468/5.8 +J7469/5.8</small>	Build out Corner Cleats <small>JC298 (Black)</small>
--	--	---

**3** Select Powder Coat Type, colour  Check

Standard Duralloy	Premium Duratec	<b>Specify PC Colour and Code</b>
-------------------	-----------------	-----------------------------------

Check any coastal Zone requirements.

**4** Notes

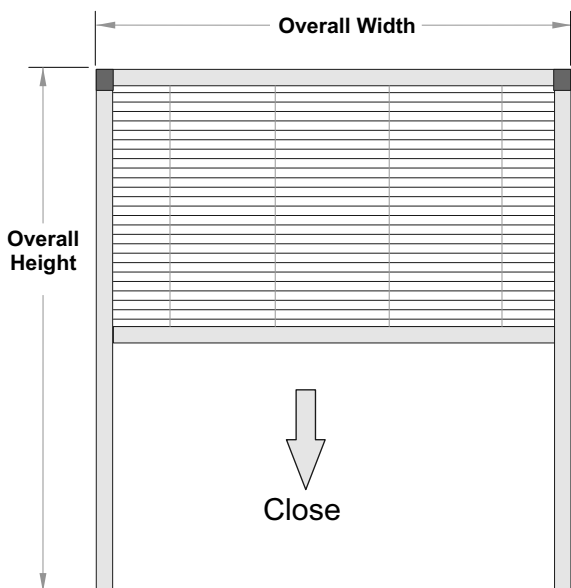

Juralco Venette™ Vertical Window Mesh Kits to suit Window opening sizes		
Height Range mm	Width Range 500mm - 1200mm	Width Range 1201mm - 1800mm
500 - 1000	A kit	E kit
1001 - 1250	B kit	NA
1251 - 1500	C kit	NA
1501 - 1800	D kit	NA

Venette™ Vertical Window  
Layout and components. Side View

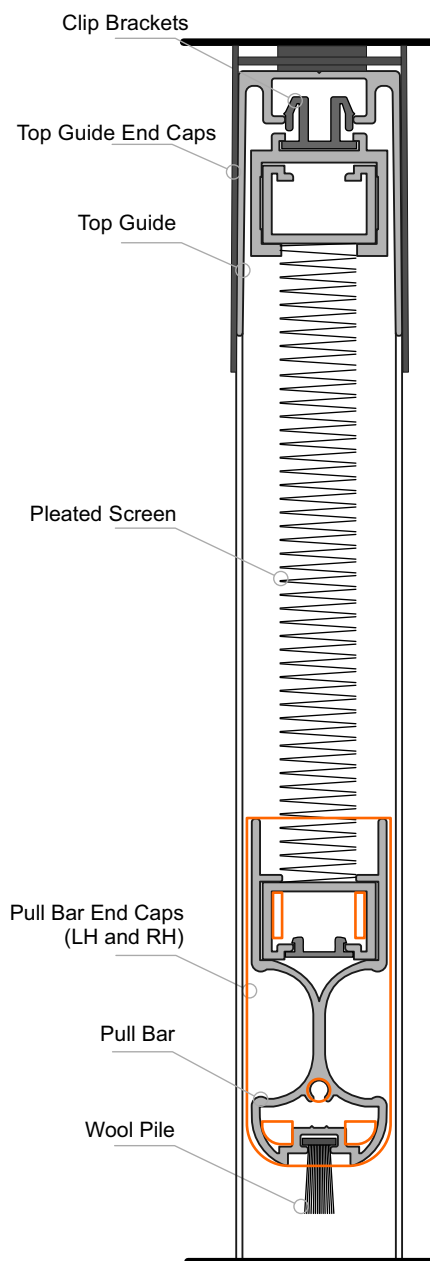

Mesh Pack  
For Installer

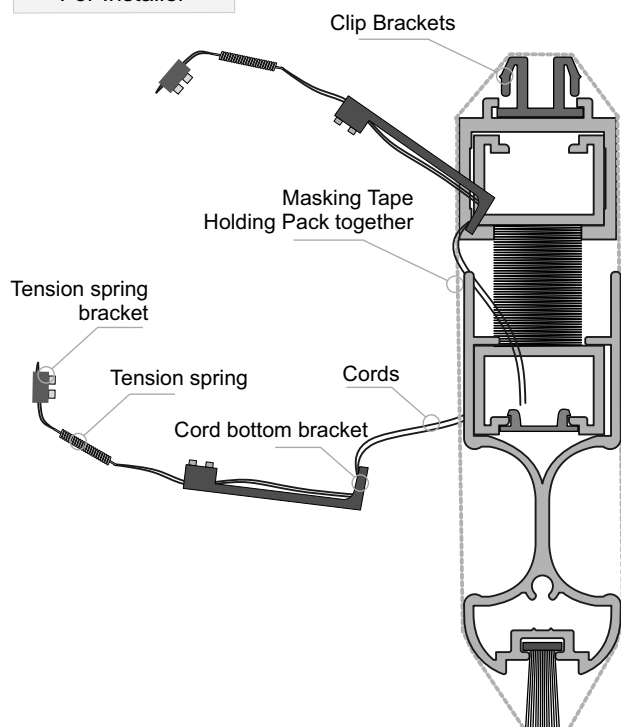

Not shown, the Pull Bar End Caps

Juralco will supply the Pleated Mesh Pack all fully assembled as enclosed below  
 Also supplied are 1 x Top Guide and 2 x Side guides  
 All cut to length and Powder Coated to a colour of your choice.  
 Supplied loose are 2 x Top Guide End Caps.  
 You to install incl the 2 x Cord Puller sets

- ① Top and Side Guides
- ② Top Guide End Caps
- ③ Clips
- ④ Pull Bar
- ⑤ Pile
- ⑥ Pull bar end cap - Right
- ⑦ Pull bar end cap - Left
- ⑧ Mesh pack
- ⑨ Cord carrier
- ⑩ Spring
- ⑪ Cord block

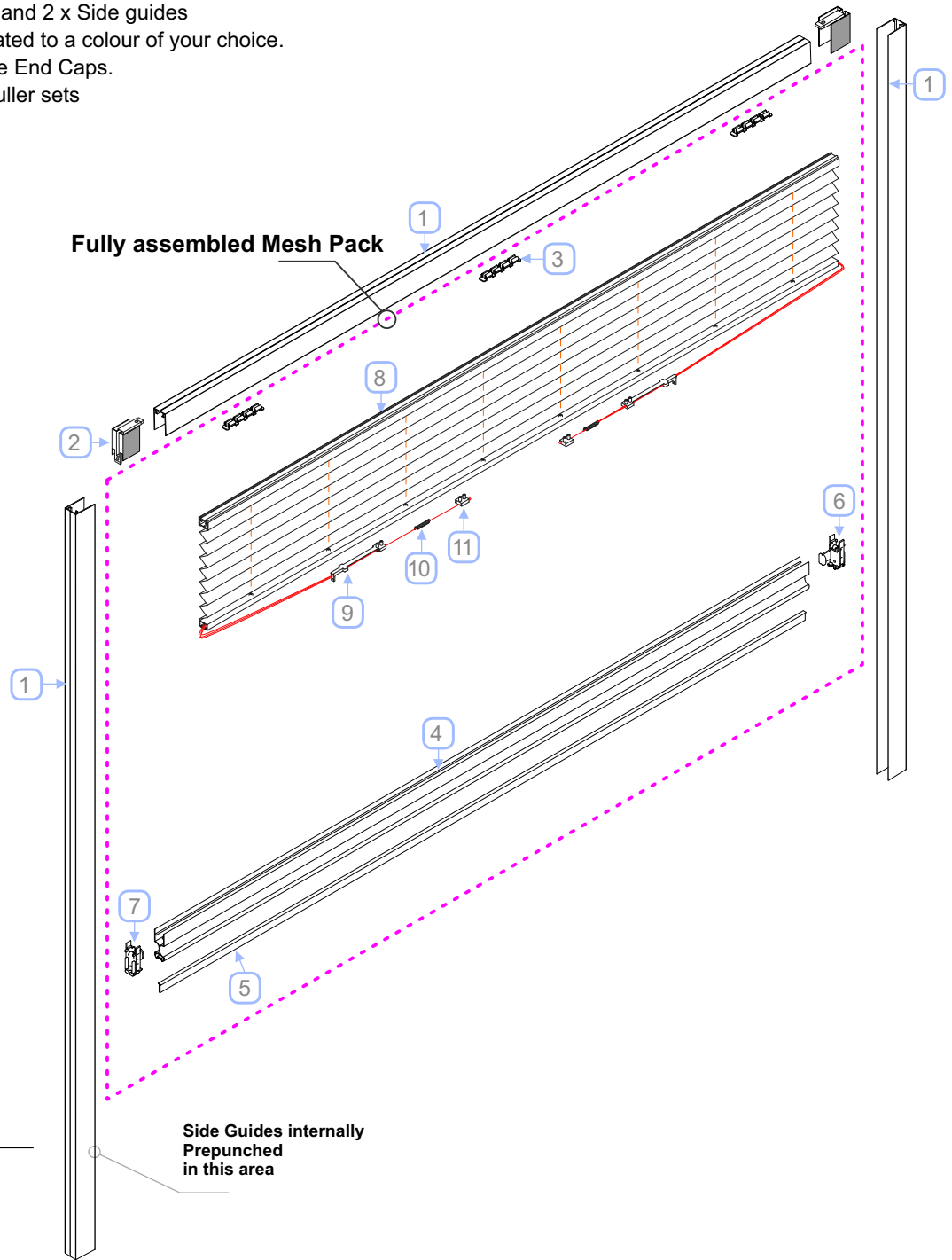

Profile Sections

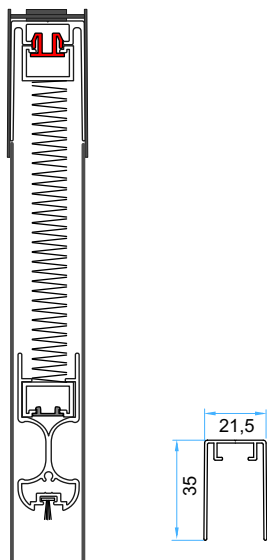

Opening Options

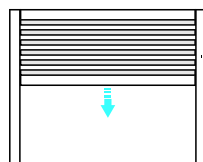

Max Dimensions

**Pleated 22mm Vertical Mesh Window Units**  
Window Openings sizes  
 Min/Max Height x Max Width Dimensions

A Kit	500mm - 1000mm high x 1200mm wide
B kit	1001mm - 1250mm high x 1200mm wide
C Kit	1201mm - 1500mm high x 1200mm wide
D Kit	1501mm - 1800mm high x 1200mm wide
E Kit	500mm - 1000mm high x 1800mm wide



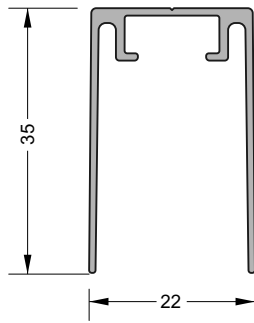

TOP and SIDE GUIDES - 5m  
 Part No JPM/31-01010-0-0

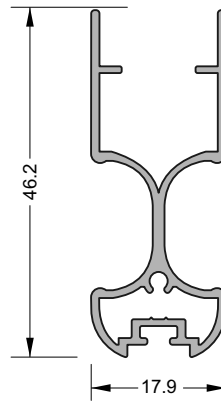

PULL BAR - 5m  
 Part No JPM/31-01000-0-0

**Pleated 22mm Vertical Window Mesh Units**

Maximum dimensions

- JPM/31-12500-4-5. 1000mm high x 1200mm wide
- JPM/31-12510-4-5. 1250mm high x 1200mm wide
- JPM/31-12520-4-5. 1500mm high x 1200mm wide
- JPM/31-12530-4-5. 1800mm high x 1200mm wide
- JPM/31-12540-4-5. 1000mm high x 1800mm wide

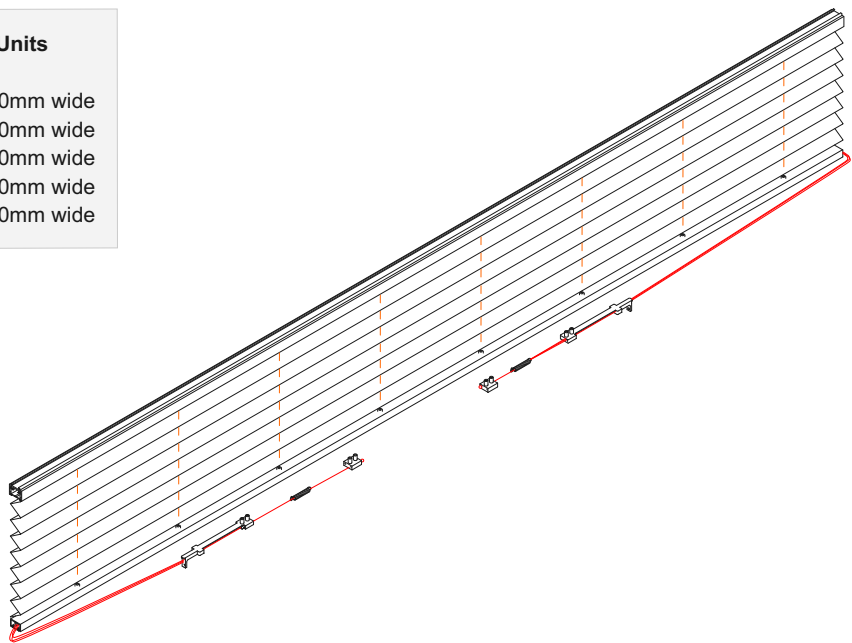

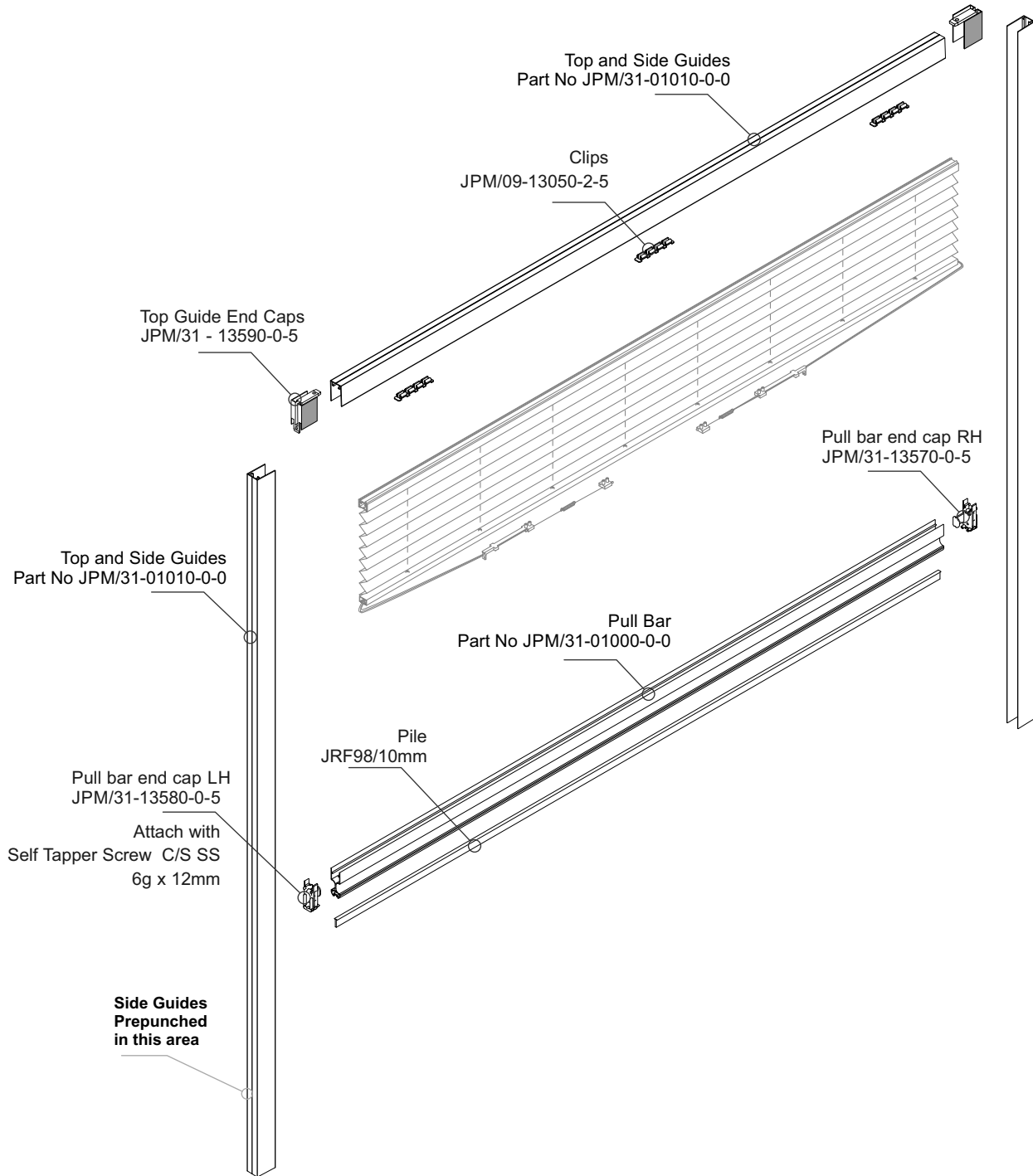

## SAFETY NOTICE

- During transport and handling make sure the product is not dropped as the plastic parts may be seriously damaged.
- Don't place materials other than the needed parts on the product.
- While unpacking, make sure you do not scratch or damage the product with cutters or other tools.
- The installer shall ascertain that the fixtures included in the product are fit for the type of installation chosen.

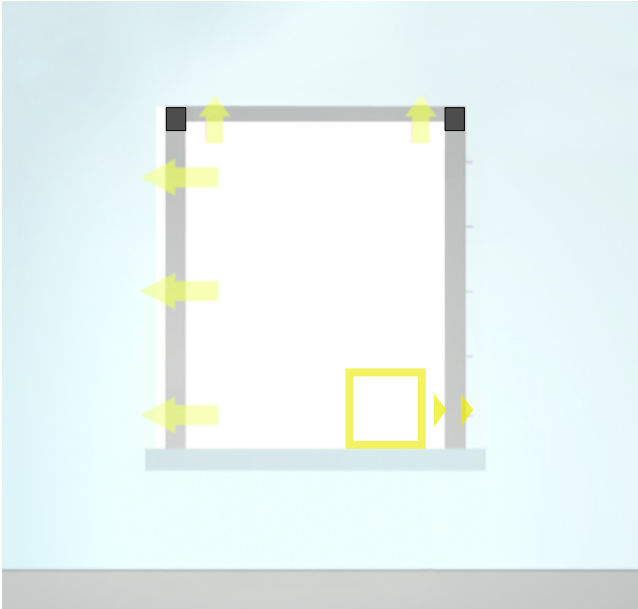

1 - Assemble the Frame. 1 x Top Guide and 2 x Side Guides, using 2 x Top Guide End Caps.

2 - Screw the Top and Side guides to the inside the Window frame using suitable SS screws

Note : Top guide and Sill must be to within 10mm parallel  
Any more out of parallel, pack the Top guide back to square

**Attention: Ensure the pre punched ends of the side guide are at the bottom.**



3 - Cut the adhesive tapes which hold the cords and their components onto the mesh pack. Let them drop free.

4 - Place the mesh pack inside the Top Guide frame.  
Press up to clip into place.

5 - Tape the Mesh Pack to the Top Guide frame

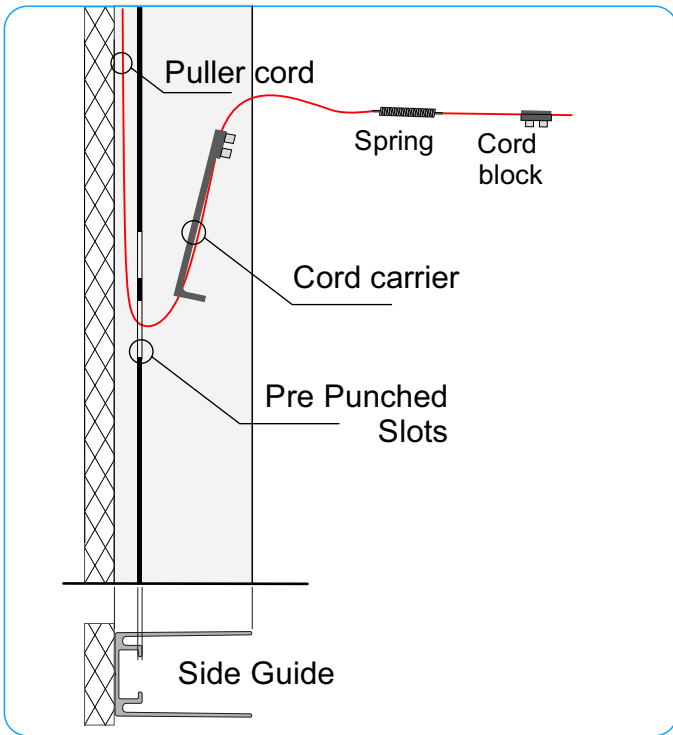

Starting with the Mesh Pack clipped and taped to the Top Frame  
**ATTENTION: Make sure that during this operation you do not cross the Puller cords. Keep them apart and even.**

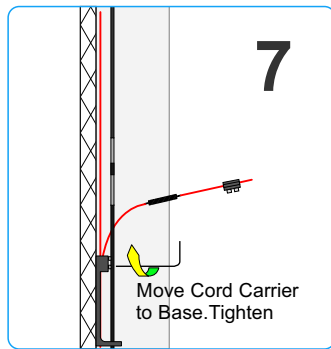
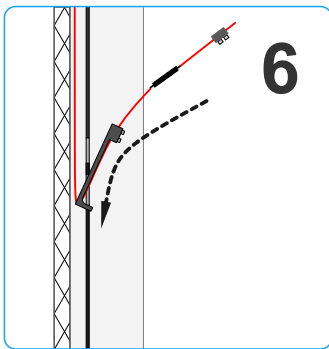

6 - Insert the Cord carrier into the **lower slot** opening in the Bottom part of the Frame,

7 - Slide the Cord carrier downwards to the Base of the Frame and attach it in place with the two Allen screws.

8 - Now insert the Cord block and Spring into the **upper slot** opening and pull upwards till the cords are smoothly tensioned.

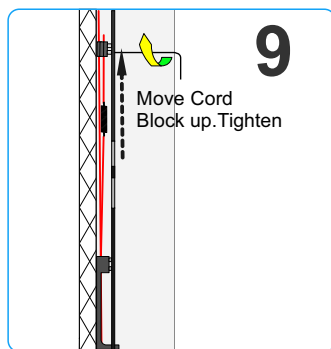
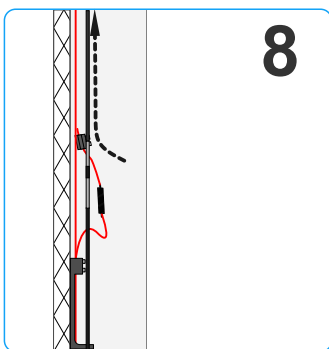

9 - Fasten it in place with the two Allen screws.

Repeat these operations for both Side guides.



10 - Now cut and remove the remaining strips holding the mesh pack and open the Venette screen.

If needed, you may adjust the parallelism and the smoothness of the screen by raising or lowering the Cord block + Spring

**ATTENTION: For a correct operation of the screen, don't tension too much: the tension must be just enough to stop the blind from descending on its own.**

**Juralco Venette™ Retractable Pleated Insect Screens - Vertical Window - Order Form**

Customer		Date
<b>Venette Pleated VERTICAL WINDOWS</b>	Order No	Contact
	<b>WO</b> Juralco <b>BR</b> Juralco <b>SO</b> Juralco <b>\$</b> Juralco	
Enter Dimensions. Enter Kit Code Choose Finish Then scan and send to <a href="mailto:sales@juralco.co.nz">sales@juralco.co.nz</a>		

1 Enter Sizes  Check

This Order for Venette Pleated Vertical Windows			
Enter, Overall Height and Width, mm		Kit Code	No Identical
<b>Unit 1</b>	Height		
	Width		
<b>Unit 2</b>	Height		
	Width		
<b>Unit 3</b>	Height		
	Width		
<b>Unit 4</b>	Height		
	Width		
<b>Unit 5</b>	Height		
	Width		

Each Kit consists of: 2 x Prepunched Side Guides, 1 x Top Guide and 1 x Mesh Pack. All supplied in lengths cut to order.  
All Aluminium extrusions Power coated to request.  
Also 2 x Black Plastic End Caps

**Venette Pleated Vertical Window Units**

Juralco Venette™ Vertical Window Mesh Kits to suit Window opening sizes		
Height Range mm	Width Range 500mm - 1200mm	Width Range 1201mm - 1800mm
500 - 1000	A kit	E kit
1001 - 1250	B kit	NA
1251 - 1500	C kit	NA
1501 - 1800	D kit	NA

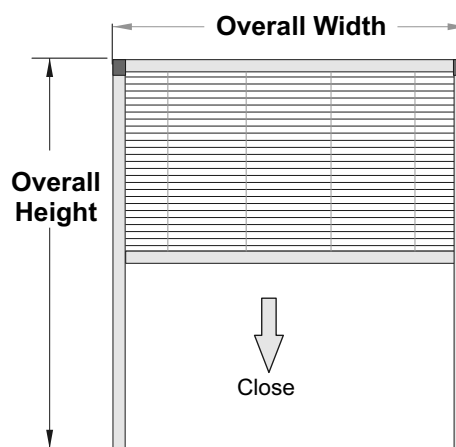

2 Select Powder Coat Type, colour

Standard Duralloy	
Premium Duratec	

**Specify PC Colour and Code**

Check      Check any coastal Zone requirements.

3 Notes



Juralco will supply the Pleated Mesh Pack all fully assembled as enclosed below  
 Also supplied are 1 x Top Guide, 2 x Side guides and 1 x Bottom Track  
 All cut to length and Powder Coated to a colour of your choice.  
 Supplied loose are 2 x Top Guide End Caps  
 You to install incl the 4 x Cord Puller sets

- ① Top and Side Guides
- ② Top Guide End Caps
- ③ Bottom Track
- ④ Double sided tape for Bottom Track
- ⑤ Clips
- ⑥ Magnet Holder
- ⑦ Positive magnet
- ⑧ Negative magnet
- ⑨ Pull bar
- ⑩ Top end cap Pull bar
- ⑪ Bottom end cap Pull bar
- ⑫ Setting plate
- ⑬ Mesh unit and cords
- ⑭ Puller cords
- ⑮ Cord carrier
- ⑯ Spring
- ⑰ Cord block

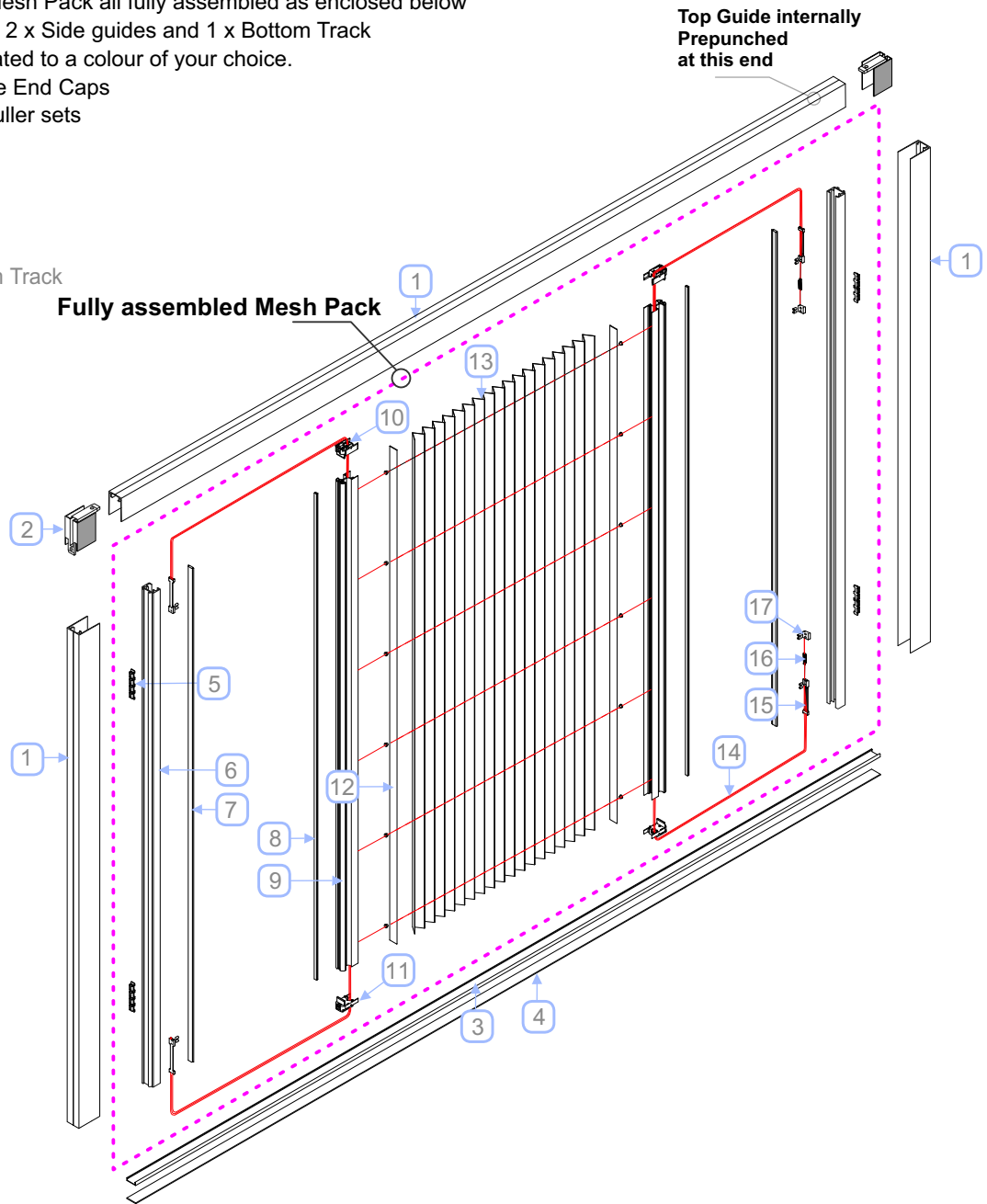

Profile Sections

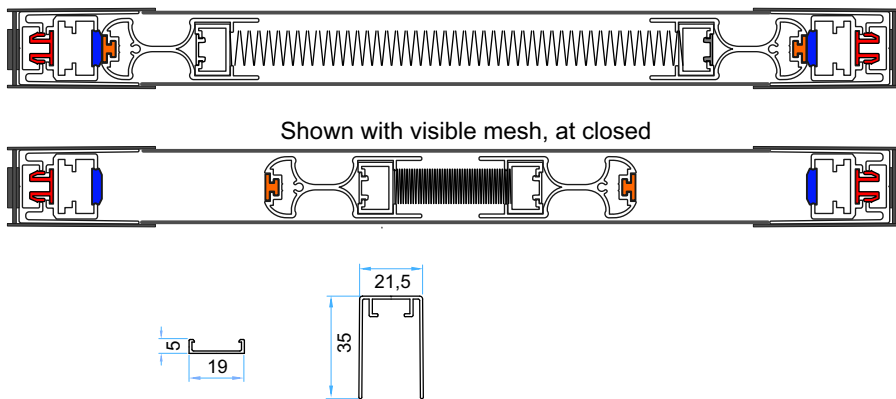

Opening Options

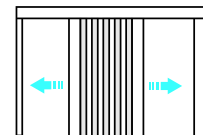

Max Dimensions

**Pleated 22mm Horizontal Window.**

Window opening Heights all 720 to 1300mm  
 Window opening Widths 800mm to 3000mm

Orders must specify the exact  
 Window opening Height and Width  
 at a square setout.

**Venette Horizontal Windows are not suitable for High Wind Areas.**

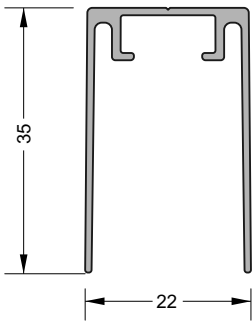

**TOP and SIDE GUIDES**  
Part No JPM/31-01010-0-0

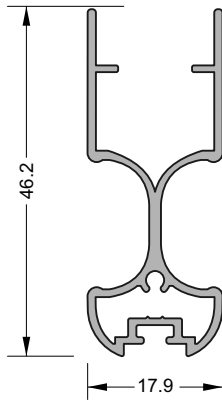

**PULL BAR**  
Part No JPM/31-01000-0-0

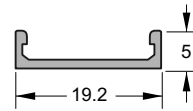

**BOTTOM TRACK**  
Part No JPM/31-01020-2-5

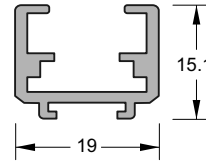

**MAGNET PROFILE**  
Part No JPM/31-01050-2-5

**Pleated 22mm Horizontal Window.**

Window opening Heights all 720 to 1300mm  
Window opening Widths 800mm to 3000mm

Orders must specify the exact  
Window opening Height and Width  
at a square setout.

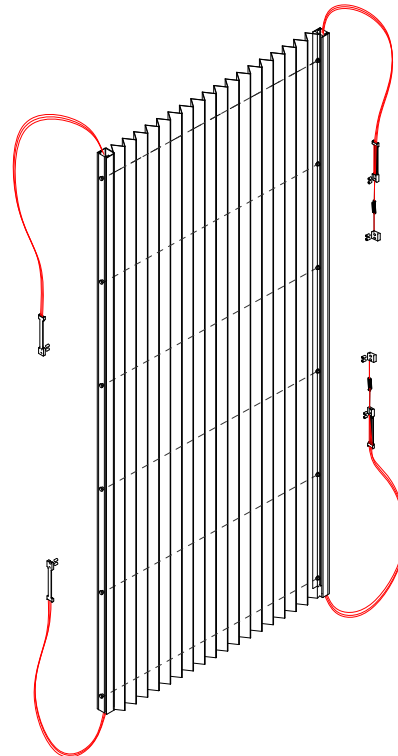

**Venette Horizontal Windows are not suitable for High Wind Areas.**

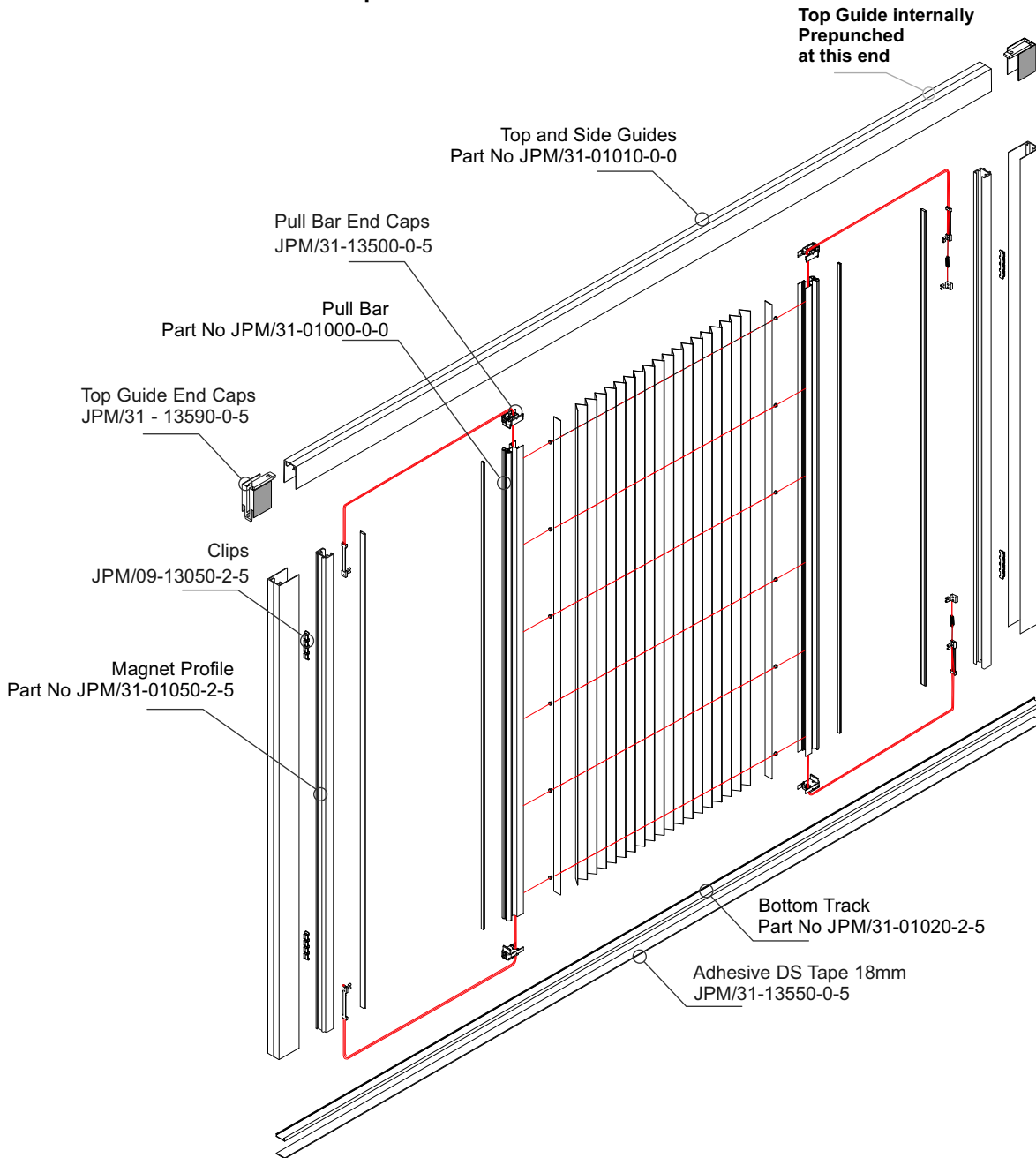

<p>Adhesive DS Tape 18mm JPM/31-13550-0-5</p>	<p>For Bottom Guide</p>	<p>Clip brackets JPM/09-13050-2-5</p>	<p>Magnets.</p>		
			<p>Negative</p>	<p>Positive</p>	
<p>Top Guide End Caps JPM/31 - 13590-0-5</p>	<p>RH and LH</p>	<p>Pull Bar End Caps JPM/31-13500-0-5</p>	<p>Wheel for End Caps JPM/09-13520-0-5</p>	<p>Pin for Wheel JPM/09-13520-0-5</p>	<p>Pull Bar End Caps Incl Wheel in place</p>
		<p>No Wheel</p>			

**Venette Horizontal Windows are not suitable for High Wind Areas.**

**Packaging**

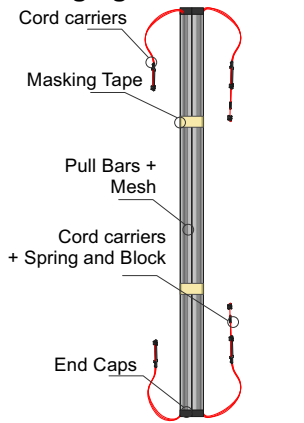

Fig 2.1 - Mesh+ Pull bars.  
 Taped closed  
 Includes negative Magnets  
 mounted in Pull Bars

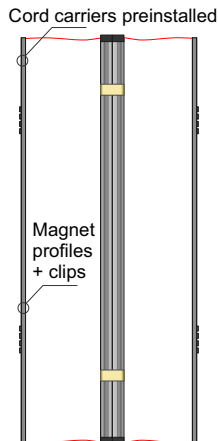

Fig 2.2 - Cord Carriers  
 preinstalled  
 in Magnet Profiles

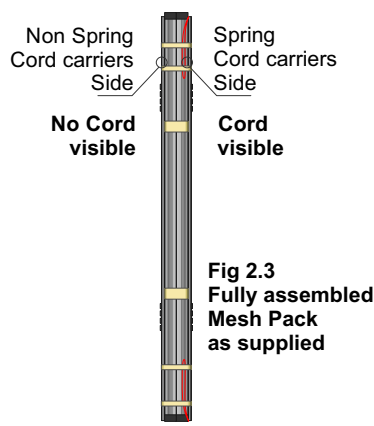
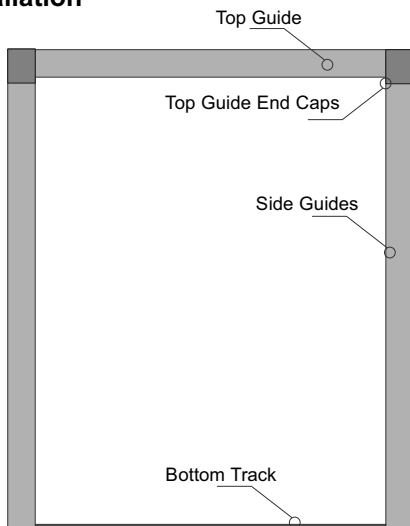

Fig 2.3  
**Fully assembled Mesh Pack as supplied**  
 Identify the correct sides before Installing

**Unpacking**

- Remove all the cardboard packaging from around the product. Do not to cut or mark the insect screen with cutter or scissors.
- Ensure all parts are clean, tidy and are undamaged.

**Installation**



- 1 - Assemble the Frame. 1 x Top Guide and 2 x Side Guides, using 2 x Top Guide End Caps.
- 2 - Screw the Top and then the Side guides to the inside the Window frame using suitable SS screws  
 Note : Top Guide and Sill/Base must be to within 10mm parallel. Any more out of parallel, pack the Top guide back to square
- 3 - After cleaning the Sill/Base, attach Bottom Track to the base using the DS foam tape

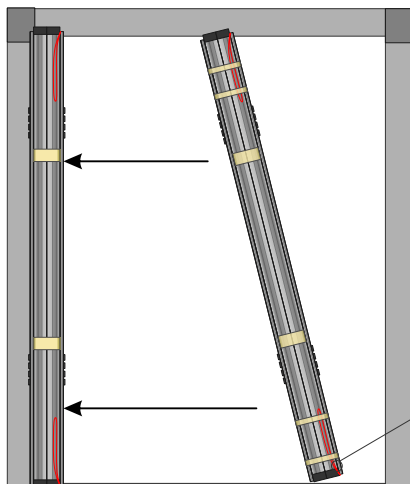

- 4 - Tilt/ Push the Mesh Pack up into the Top Guide then drop onto the Bottom Track, now Vertical.
  - Remove Outer Tape
  - Push across and Clip the Non Spring side into the Side Profile

**Venette Horizontal Windows are not suitable for High Wind Areas.**

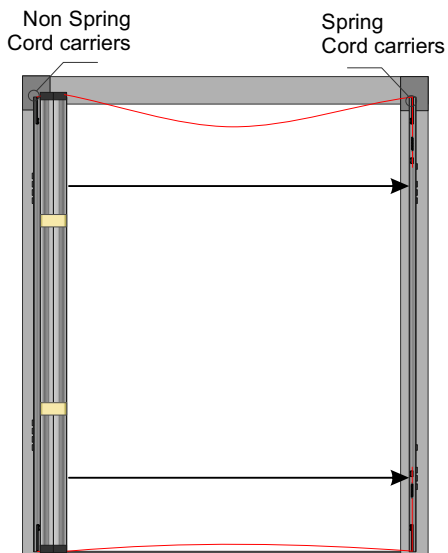

- 5 - Then Clip Spring Cord Carrier + Magnet Profile into the opposite Side Profile

**Notes**

- 1 - The Screen is not correctly tensioned yet.
- 2 - The puller cords are trimmed to suitable lengths in the Factory

**DO NOT TWIST CORDS. ALL CORDS SHOULD BE PARALLEL AND FREE FLOWING**

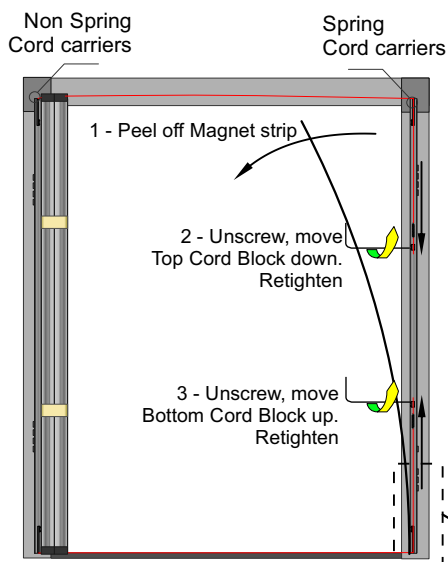

- 6 - Adjust Spring Tensions:
- 1 - Gently peel the Magnet strip off from the Top and remove.
  - 2,3 - Adjust tension for both Cord Blocks as necessary. Do not over tension. Should be just firm.

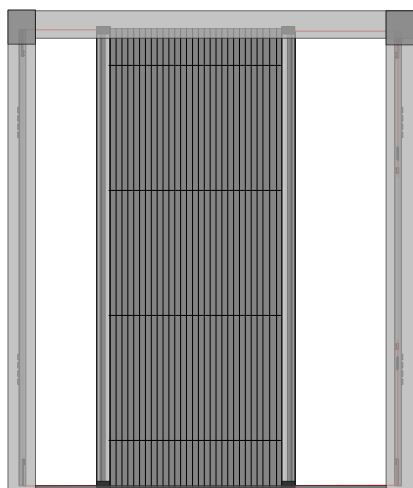
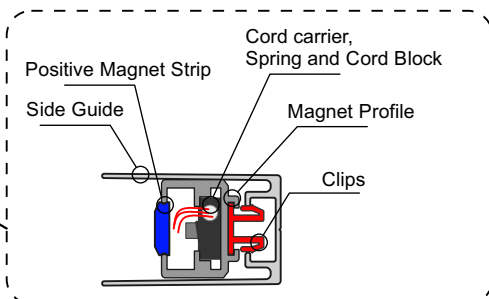

- 7 - Final Testing
- Remove all Tape
  - Test for..
  - Magnet closures all OK
  - Sliding Smoothly over full range all OK
  - Fine tune Cord Block positions if necessary
- 8 - Replace Magnet strip, after adjustments.  
 (A small Roller may be necessary)
- 9 - Clean up the area, leave tidy and clear.  
 Wipe surfaces clean

**Venette Horizontal Windows are not suitable for High Wind Areas.**

Customer		Date
<b>Venette Pleated HORIZONTAL WINDOWS</b>	Order No	Contact
	<b>WO</b> Juralco <b>BR</b> Juralco <b>SO</b> Juralco <b>\$</b> Juralco	

Enter Dimensions. Enter Kit Code Choose Finish Then scan and send to [sales@juralco.co.nz](mailto:sales@juralco.co.nz)

**1** Enter Sizes  Check    **Venette Horizontal Windows are not suitable for High Wind Areas.**

This Order for Venette Pleated Horizontal Windows			
Enter, Overall Height and Width, mm		Kit Code	No Identical
<b>Unit 1</b>	Height		
	Width		
<b>Unit 2</b>	Height		
	Width		
<b>Unit 3</b>	Height		
	Width		
<b>Unit 4</b>	Height		
	Width		
<b>Unit 5</b>	Height		
	Width		

**Venette Pleated Horizontal Window Units**

Height mm	Overall Width - up to mm					
	1000	1250	1500	1800	2400	3000
720 - 1300	F kit	G kit	H Kit	J Kit	K Kit	L Kit

Each Kit consists of: 1 x Top Guide, 2 x prepunched U Profiles + Magnets and 1 x Bottom Track (Black only) and 1 x Mesh Pack. All supplied in lengths cut to order. All Aluminium Power coated to request. Also 2 x Black Plastic End Caps and screws

**2**    Select Powder Coat Type, colour

Standard Duralloy	<b>Specify PC Colour and Code</b>
Premium Duratec	

Check    Check any coastal Zone requirements.

**3**    Notes

## Powder Coating Installation Care

### Warning re use of solvents:

- In some cases strong solvents are recommended for thinning various types of paints and also for cleaning up mastics and sealants.
- These can be harmful to the extended life of the powder coated surface, and must not be used for cleaning purposes.
- It is important to note that the damage will not be visible immediately and may take up to 12 months to develop.

If paint splashes or sealants and mastics need to be removed then the following may be safely used:  
Methylated Spirits, Ethyl Alcohol, Isopropanol or preferably a mild detergent in warm water.

### Joinery Protection during Installation:

All the activity on a construction site means that your powder coated items may get knocked or scratched, splattered with mortar, plaster, textured coating or paint during the later stages of construction.

Please ensure that all powder coated articles are masked or covered at this time. It is far easier to prevent accidents than to try and correct them. Should your joinery receive mortar or paint splashes see that these are removed before cure and follow the instructions contained in this brochure.

Typical sticker used to warn other trades of the need to protect and mask off powder coated joinery (applies to anodised joinery also)

**"IMPORTANT ALL TRADES"**  
This valuable aluminium joinery will suffer permanent damage from: plaster, mortar and paint splashes - Protect if splashes occur - Immediately wash down joinery with water or meths - Do not allow splashes to harden! - Do not use solvents! - Do not remove this label until final clean completed.

This photograph display damage that has occurred on site, post installation. The photo of the masked joinery displays clear signs of damage that could have occurred were it not masked. Please ensure that your joinery is protected right through the entire construction process.



## Powder Coating Maintenance

### External - Maintenance Program:

To extend the life of external powder coated articles and to comply with warranty requirements for powder coated aluminium joinery, a simple, regular maintenance program must be implemented.

The effects of ultra violet light, atmospheric pollution, dirt, grime and airborne salt deposits will all accumulate over time and must be removed or surface staining and weathering will occur, leading to an unsightly appearance.

For external coatings, cleaning should take place every six months. In areas where pollutants are more prevalent, such as beachfront houses and industrial or geothermal areas, then a cleaning program should be carried out on a more frequent basis ie. every one to three months.

### Cleaning your powder coating:

1. Carefully remove any loose surface deposits with a wet sponge.
2. Use a soft brush (non abrasive) and a mild household detergent (do not use solvents) in warm water, remove dust, salt and other deposits.
3. Rinse off with clean fresh water.



### Restoring weathered or scratched surfaces:

Repair of Scuffed or Scratched surfaces  
Dulux Spray Cans are available in all colour card colours.

Repair of Small Scratches or Chips.  
Dulux Dabsticks are ideally suited for the repair of small scratches.  
Dabsticks may not be available in all colour card colours.

Repair of Weathered areas .  
Dulux Gloss Up is a light to medium cutting cream ideally suited for gloss restoration and has been specifically designed for this purpose.  
Gloss Up contains no waxes or silicone and is a one step system.



Contact Dulux Powder Coatings , ph 0064 9 441 8244