



Juralco Frameless Shower Systems

Juralco Aluminium Building Products Ltd designs and distributes specialist aluminium joinery systems through a national network of franchised fabricators and agents.

For more than 25 years we have been at the forefront of specialist aluminium door and window products suitable for New Zealand joinery and building methods. Our product range includes security and insect screens, balustrades and gates, Louvre Roofs, shutters and awnings, shower screens, wardrobe doors and organisers and internal doors.

Juralco Framless Shower enclosures are custom designed installations for medium to larger sized bathrooms. With clean elegant lines they are especially suited to the contemporary modern home or hotel. They are available as full height Shower enclosures or as Bath Screens in 10mm Toughened Glass. Layouts includes a Hinged door with 90 or 45 deg Returns or as a fixed panel, having no door. Sliding options include Single and Double Doors. The mounting aluminium extrusions, Hinges and Handles are available in a range different finishes. Refer to top of p4 for details.

Index

Heading	Pages	Description
Typical Layouts	3	General Arrangements. Hinged and Sliding
Extrusions and Components	4 - 11	Shows all Extrusions and Components
Measuring	12	Shows typical measurements needed
Hinged Panels - Cutting	13	Shows necessary Hinged Panel Height and Width cutting allowances
Hinged Cutting Calculators	14 - 16	Shows Hinged Panels cutting calculations
Over Panels	17	Shows various Over Panels
Bath Screens	18	Shows details relating to Bath Screens
Hinged Installation Tips	19	Shows on site Installation Tips
Hinged Order Forms	20 - 32	Glass Panel Order forms for Hinged configurations
Sliding Panels - Cutting	33	Shows necessary Sliding Panel Height and Width cutting allowances.
Sliding Installation Tips	34 - 35	Shows Oasis Sliding Kit, and Install instructions
Sliding Order Forms	36 - 42	Glass Panel Order Forms for various Oasis Sliding configurations
Special Order Pages	43 - 44	Order Forms, Blank for special configurations

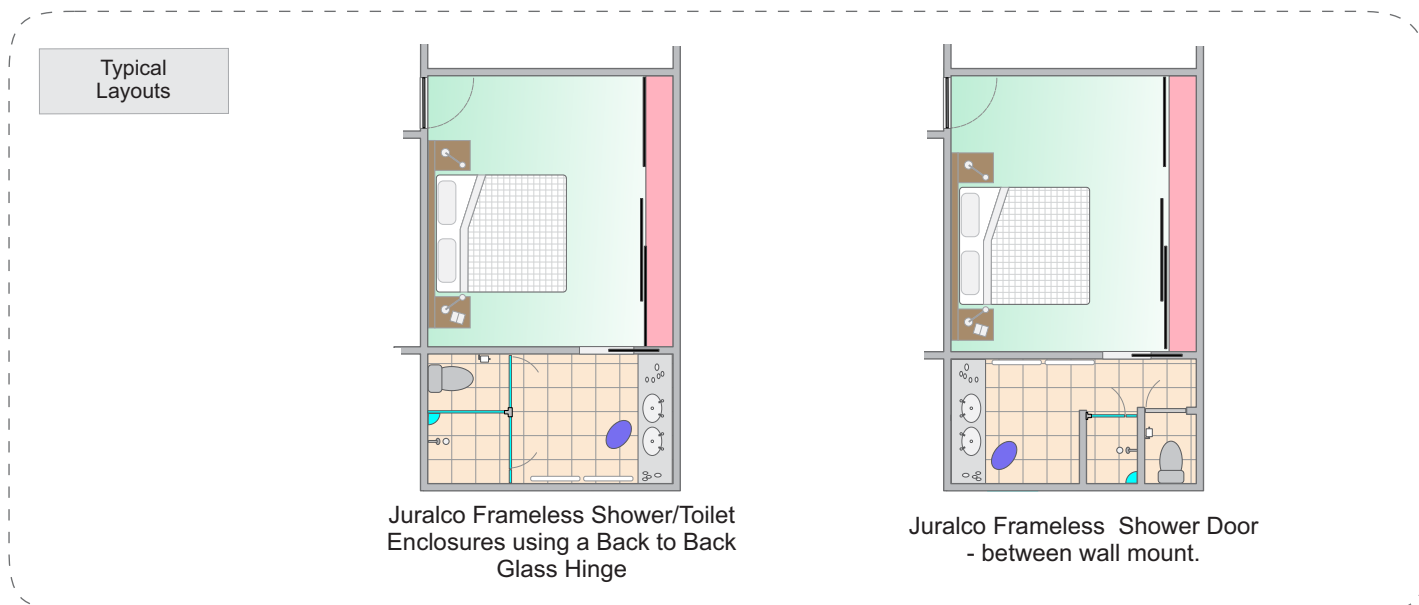

All pages © Copyright Juralco Aluminium Building Products Ltd, 2023

Juralco Frameless Shower Systems - General Descriptions

General Description

GENERAL DESCRIPTION

- The Shower Enclosure is not load bearing.
- All glass is toughened and the hinge systems provides for 10mm glass thicknesses, all to NZS 4233 Part 3 for human impact requirements.
- Also available as fixed panels, having no door.
- Although most enclosures are specially built to suit the designers requirements there are restrictions relating to door and glass panel sizes. All designs are checked to ensure compliance with regulations.
- All components are non rusting. Screws, springs and pins are manufactured in stainless steel. All hinges, handles and brackets are manufactured from solid brass.
- Most hinges have a cam action which allows the door to swing open and to self close from 20 degrees.
- The standard door height is 1900mm, but can range from 1850mm to 2100mm depending upon client specification.
- Normal Door width is 650mm. Minimum Side Panel width (for Glass to Glass hinge) is 150mm, otherwise 100mm.
- For doors hinged directly from the wall adequate stud fixings are required. Where inadequate wall fixing is suspected it is recommended the door be hinged from a glass Sidel Panel.

Typical Hinged Layouts

- Door Hinges come in two basic types, Wall mount or Glass mount.
- The Wall mounts are always 90 deg. Glass mounts may be 180 deg or 135 deg.
- Hinge selection depends on width and available wall fixings. Normally 2 per door, but 3 if door over 40kg.
- All shower enclosures are for 10mm Toughened Glass
- Doors normally 650mm wide. Height normally 1900mm
- Various Overhead bracing Struts are available to stabilise Panels.

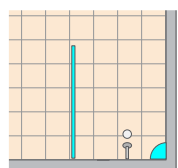
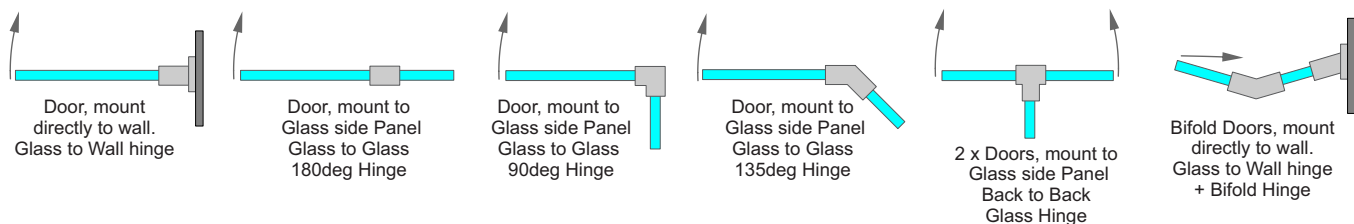

Fixed Panel, no Door

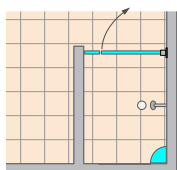

Glass Door Between Walls mount. Glass to Wall Hinge

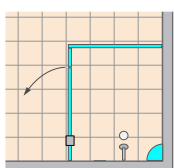

Glass Door and 90 deg Return Glass to Glass 180deg Hinge

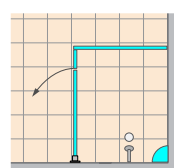

Glass Door and 90 deg Return Glass to Wall Hinge

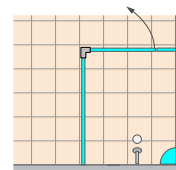

Glass Door and 90 deg Return Glass to Glass 90deg Hinge

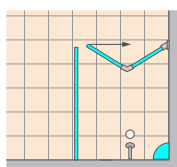

Bifold Glass Doors, mount directly to wall. Glass to Wall hinge + Bifold Hinge

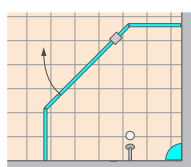

Glass Door and 2 x45 deg Returns Glass to Glass 180deg hinge

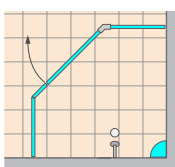

Glass Door and 2 x 45 deg Returns Glass to Glass ,135deg hinge

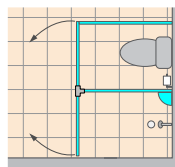

Glass Doors and 2 x 90 deg Returns Back to Back Glass Hinge

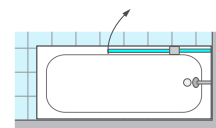

Glass Door Glass to Glass 180deg Hinge

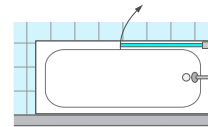

Glass Door Wall mount. Glass to Wall Hinge

Typical Sliding Layouts

- Sliding Door using Oasis Hardware Kits
- All shower enclosures are for 10mm Toughened Glass
- Doors normally 750mm wide. Height normally 1900mm
- Various Overhead bracing Struts are available to stabilise Panels.

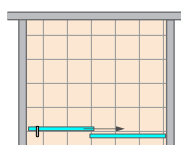

Wall to Wall 2 x Panel system

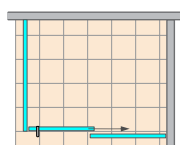

Wall to 90deg Glass Return 2 x Panel system

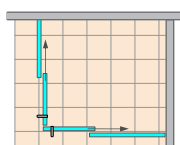

Double Sliding Doors Wall to 90deg Glass Return 4 x Panel system

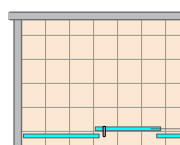

Wall to Wall 3 x Panel system

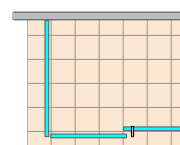

Wall to 90deg Glass Return 3 x Panel system

Juralco Frameless Shower Systems - Extrusions, Components

Codes	Finishes
BB	Brushed Brass
BG	Brushed Gold
BN	Brushed Nickel

Codes	Finishes
BRG	Brushed Rose Gold Copper
CP	Polished Chrome
GM	Brushed Gun Metal
MB	Matt Black

Codes	Finishes
NAT	Natural Anodised
PSS	Polished SS
SB	Satin Brass
SCC	Powder Coated

Codes	Finishes
SCP	Satin Chrome
SN	Brushed Satin Nickel
SSS	Satin SS
STE	Sterling Bright Anodised

Glazing Channels

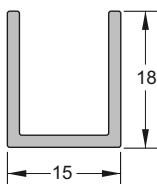

CHANNEL
15mm x 18mm
H/3877/2.1
and H/3877/3

Finishes
2.1 = STE, NAT, MB, SCC
3 = STE, NAT, MB, SCP
SN, GM, BB, BG, SCC

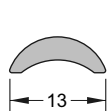

WATERBAR
H/978/2.8

Finishes
STE, NAT, MB, SCP, BN, BB
SN, GM, BG, BRG, SCC

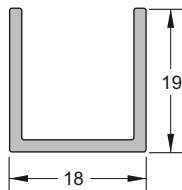

CHANNEL
18mm x 19mm
H/970/2.1
and H/970/3

Finishes
2.1, 3 = STE, NAT, MB, SCC

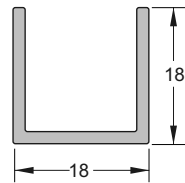

CHANNEL
18mm x 18mm
H/970/2.1
and H/970/3/
Finishes
2.1 = SCP, SN, GM, BG
3 = SCP, SN, BN,
GM, BB, BG, BRG

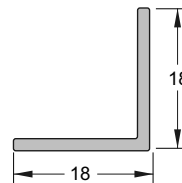

ANGLE
18mm x 19mm
H/976/2.5
Finishes
STE, NAT, SCC

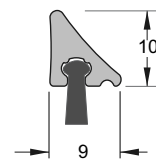

WATER SEAL
with FELT
H/979/2.8

Finishes
STE, NAT, MB, SCP, SN, BN,
GM, BB, BG, BRG, SCC

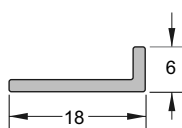

ANGLE
18mm x 6mm
H/975/2.8

Finishes
STE, NAT, SCC

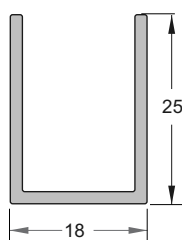

CHANNEL
18mm x 25mm
H/973/2.1
and H/973/3

Finishes
2.1, 3 = STE, NAT, SCC

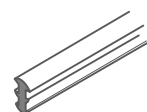

Glazing Wedge
200m Roll
PN 31

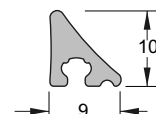

WATER SEAL
No FELT
H/980/2.8

Finishes
STE, NAT, MB, SCP, SN, BN,
GM, BB, BG, BRG, SCC

Elite Shower Hinges

All for 10mm Glass
2 x Hinges, max Door weight 40kg
(for 10mm Glass = 1.6sqm)
3 x Hinges, max Door weight 60kg

Features include

- Glued Clamp Gaskets
- Glued Notch Gaskets
- Knuckle protectors

Wall to Glass Hinge, Centered JH1

Finishes CP, SCP, MB, SN,
GM, BB, SCC

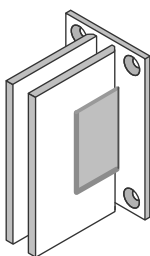

Wall fixing plate available

Wall to Glass Hinge, Offset JH1/L3

Finishes CP, SCP, MB, SN,
GM, BB, SCC

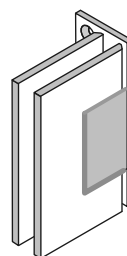

Wall fixing plate available

Glass to Glass Hinge, 180deg JH2

Finishes CP, SCP, SN, BN, MB, GM,
BB, BG, BRG, SCC

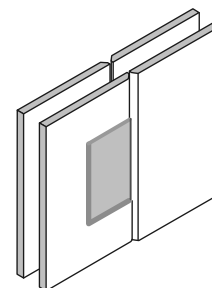

Glass to Glass Hinge, 135 deg JH2/35

Finishes CP, SCP, MB, SN,
GM, BB, SCC

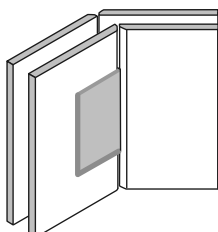

Glass to Glass Hinge, Bifold JH2/BF

Finishes CP, SCP, BN, MB, SCC

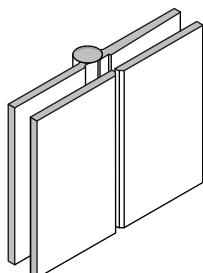

Glass to Glass Hinge, 90deg JH2/90

Finishes CP, SCP, BN, MB, SCC

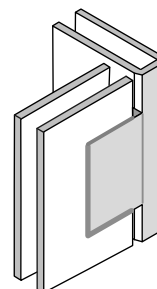

Back to Glass Hinge, 90deg JH3/90

Finish CP

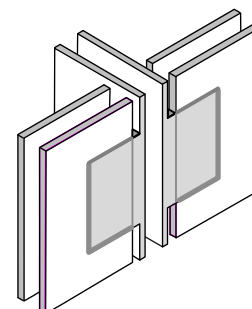

Juralco Frameless Shower Systems - Components



Codes	Finishes
BB	Brushed Brass
BG	Brushed Gold
BN	Brushed Nickel

Codes	Finishes
BRG	Brushed Rose Gold Copper
CP	Polished Chrome
GM	Brushed Gun Metal
MB	Matt Black

Codes	Finishes
NAT	Natural Anodised
PSS	Polished SS
SB	Satin Brass
SCC	Powder Coated

Codes	Finishes
SCP	Satin Chrome
SN	Brushed Satin Nickel
SSS	Satin SS
STE	Sterling Bright Anodised

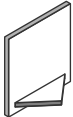
Glazing Channel End Caps

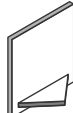
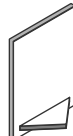
<p style="text-align: center;">Channel End Caps for 15mm x 18mm channel H/EC3877</p> <p style="text-align: center; font-size: small;">Finishes <u>STE, NAT, MB, SCP,</u> <u>BN, GM, BB, BG, SCC</u></p> 	<p style="text-align: center;">Channel End Caps for 18mm x 18mm channel H/EC1818</p> <p style="text-align: center; font-size: small;">Finishes <u>SCP, SN, GM, BN,</u> <u>BG, BRG</u></p> 	<p style="text-align: center;">Channel End Caps for 19mm x 18mm channel H/EC970</p> <p style="text-align: center; font-size: small;">Finishes <u>STE, NAT, MB, SCC</u></p> 	<p style="text-align: center;">Channel End Caps for 18mm x 125mm channel EC970/45</p> <p style="text-align: center; font-size: small;">Finishes <u>STE, NAT, MB, SCC</u></p> 
--	--	--	---

Over Panel Clips

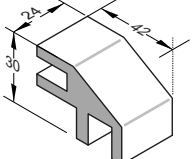
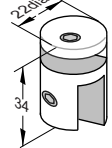
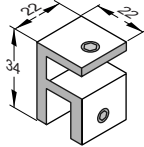
<p style="text-align: center;">Chamfered Over Panel Clip 10mm to 6mm Glass OP/10C</p> <p style="text-align: center; font-size: small;">Finishes <u>PSS, SCP, BN, SN, MB, GM,</u> <u>BB, BG, BRG, SCC</u></p>  <p style="font-size: x-small;">Fits 6mm Glass Horizontal Fits over 10mm Glass Vertical Clamp screws. Gaskets included</p>	<p style="text-align: center;">Round Over Panel Clip 10mm to 6mm Glass OP/10R</p> <p style="text-align: center; font-size: small;">Finishes <u>CP, SCP, BN, SN, MB, GM,</u> <u>BG, BB, SCC</u></p>  <p style="font-size: x-small;">Fits 6mm Glass Horizontal Fits over 10mm Glass Vertical Clamp Screws. Gaskets included</p>	<p style="text-align: center;">Square Over Panel Clip 10mm to 10mm Glass OP/1010S</p> <p style="text-align: center; font-size: small;">Finishes <u>CP</u></p>  <p style="font-size: x-small;">Fits 10mm Glass Horizontal Fits over 10mm Glass Vertical Clamp Screws. Gaskets included</p>
--	--	---

Shower Pulls

Note - Shower Pull Holes all 100mm C/L from Edge of Glass Panel

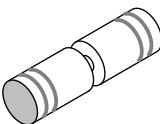
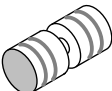
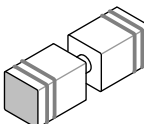
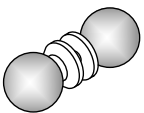
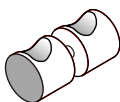
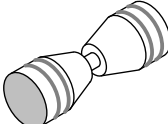
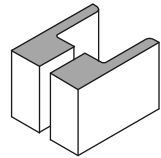
<p style="text-align: center;">Round Pull Knob Set 30mm dia x 50mm(ea) JK/25</p> <p style="text-align: center; font-size: small;">Finishes <u>CP, SCP, SCC</u></p>  <p style="text-align: center;">12mm hole</p>	<p style="text-align: center;">Round Pull Knob Set 30mm dia x 30mm(ea) H/75</p> <p style="text-align: center; font-size: small;">Finishes <u>CP</u></p>  <p style="text-align: center;">12mm hole</p>	<p style="text-align: center;">Square Pull Knob Set 25mm sq x 43mm (ea) JK/25S</p> <p style="text-align: center; font-size: small;">Finishes <u>CP, SCP, SCC</u></p>  <p style="text-align: center;">12mm hole</p>	<p style="text-align: center;">Round Pull Knob Set 30mm dia x 40mm(ea) JK/30</p> <p style="text-align: center; font-size: small;">Finishes <u>CP, SCP, SCC</u></p>  <p style="text-align: center;">12mm hole</p>	<p style="text-align: center;">Round Pull Knob Set 32mm dia x 30mm(ea) JK/32</p> <p style="text-align: center; font-size: small;">Finishes <u>CP, SCP, BN, MB, GM,</u> <u>SB, BG, SCC</u></p>  <p style="text-align: center;">12mm hole</p>	<p style="text-align: center;">Tapered Pull Knob Set 38mm dia x 43mm (ea) JK/60</p> <p style="text-align: center; font-size: small;">Finishes <u>CP, SCP, SCC</u></p>  <p style="text-align: center;">12mm hole</p>	<p style="text-align: center;">Sq Paddle Pull Knob Set 70mm x 50mm x 24mm (ea) JK/70</p> <p style="text-align: center; font-size: small;">Finishes <u>CP, SCP, SCC</u></p>  <p style="text-align: center;">2x12mm holes @32crs (vertical)</p>
--	---	---	--	---	--	---

Juralco Frameless Shower Systems - Components

Codes	Finishes
BB	Brushed Brass
BG	Brushed Gold
BN	Brushed Nickel

Codes	Finishes
BRG	Brushed Rose Gold Copper
CP	Polished Chrome
GM	Brushed Gun Metal
MB	Matt Black

Codes	Finishes
NAT	Natural Anodised
PSS	Polished SS
SB	Satin Brass
SCC	Powder Coated

Codes	Finishes
SCP	Satin Chrome
SN	Brushed Satin Nickel
SSS	Satin SS
STE	Sterling Bright Anodised

Handles

Note - Handle Holes all 100mm C/L from Edge of Glass Panel

Double D Handle
25mm dia x 275 high
JH/D250

Finishes PSS, SSS, BN, MB, GM,
BG, SN, BB, SCC

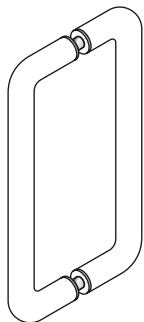

2x10mm holes @250crs

Quadrant Double D Handle
20mm sq x 270 high
JH/QC250

Finishes PSS, SSS, BN, MB, GM,
BB, SB, SN, BG, BRG, SCC

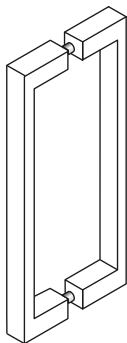

2x10mm holes @250crs

Fineline Round Double Handle
25mm dia x 350 high
JH/FR250

Finishes PSS, SSS, MB, GM,
BB, SN, SCC

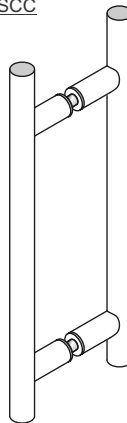

2x10mm holes @250crs

Fineline Square Double Handle
19mm sq x 350 high
JH/FS250

Finishes PSS,
MB, SSS, SCC

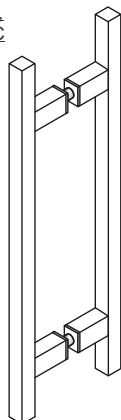

2x10mm holes @250crs

Cubeline Double D Handle
20 x 40mm rectangular
270 high H/MC250

Finishes CP

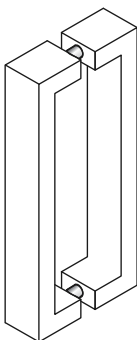

2x10mm holes @250crs

Single D & Pull Handle
25mm dia x 275 high
JH/SD250P

Finishes PSS, SSS, SCC

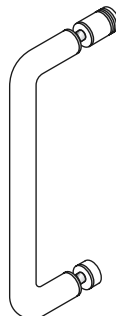

2x10mm holes @250crs

Sliding Door Pull Set
58mm dia JSS/SPP

Finishes PSS, SSS, BN, MB,
GM, SB, BG, SCC

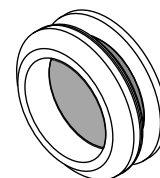

48mm hole

Towel + Pull Handles

Note - First Handle Hole all 100mm C/L from Edge of Glass Panel

Single D/Towel & Pull Handle
25mm dia x 475 wide
JH/SD400P

Finishes PSS, SSS, SCC

2x12mm holes @400crs



Single D/Towel & Pull Handle
25mm dia x 575 wide
JH/SD500P

Finishes PSS, SSS, SCC

2x12mm holes @500crs



Juralco Frameless Shower Systems - Components



Codes	Finishes
BB	Brushed Brass
BG	Brushed Gold
BN	Brushed Nickel

Codes	Finishes
BRG	Brushed Rose Gold Copper
CP	Polished Chrome
GM	Brushed Gun Metal
MB	Matt Black

Codes	Finishes
NAT	Natural Anodised
PSS	Polished SS
SB	Satin Brass
SCC	Powder Coated

Codes	Finishes
SCP	Satin Chrome
SN	Brushed Satin Nickel
SSS	Satin SS
STE	Sterling Bright Anodised

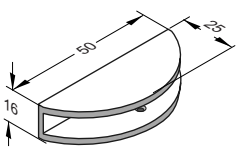
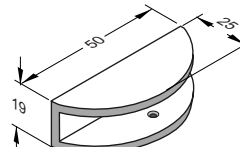
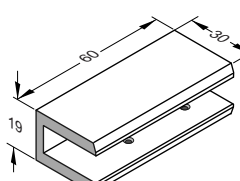
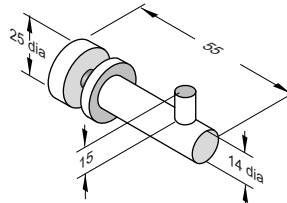
Brackets and Shelves

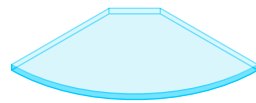
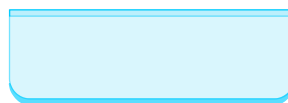
<p style="text-align: center;">Round Shelf Bracket 5-6mm Glass G/GSB6R</p> <p style="text-align: center;"><u>Finishes CP</u></p>  <p style="text-align: center;">1x10gx38 C/S screw</p>	<p style="text-align: center;">Round Shelf Bracket 8-10mm Glass G/GSB10R</p> <p style="text-align: center;"><u>Finishes CP, SCC</u></p>  <p style="text-align: center;">1x10gx38 C/S screw</p>	<p style="text-align: center;">Rectangular Shelf Bracket 8-10mm Glass G/GSB10SQ</p> <p style="text-align: center;"><u>Finishes CP, SCP, BN, MB, GM, SB, BG, BRG, SCC</u></p>  <p style="text-align: center;">2x10gx38 C/S screw</p>	<p style="text-align: center;">Towel/Robe Hook 25dia x 55mm 10mm Glass G/TRH</p> <p style="text-align: center;"><u>Finishes PSS, SCC</u></p>  <p style="text-align: center;">12mm hole</p>
<p style="text-align: center;">Glass Corner shelf 200mm 10mm Toughened Glass G/GS1/200</p> <p style="text-align: center;"><u>Clear Toughened</u></p> 	<p style="text-align: center;">Glass Corner shelf 250mm 10mm Toughened Glass G/GS1/250</p> <p style="text-align: center;"><u>Clear Toughened</u></p> 	<p style="text-align: center;">Glass shelf 150 x 300mm 10mm Toughened Glass G/GS3/300</p> <p style="text-align: center;"><u>Clear Toughened</u></p> 	

PVC Seals - Clear

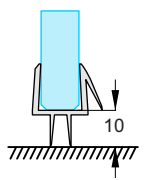
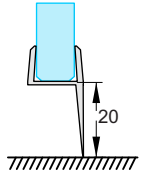
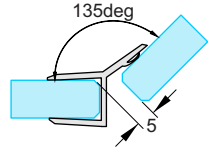
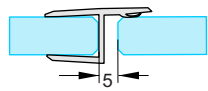
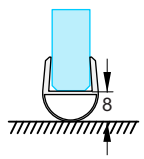
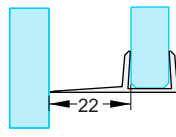
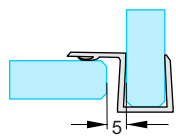
<p style="text-align: center;">Bottom Door Seal 10mm Glass G/FS01/1.4/CLE</p> <p style="text-align: center;"><u>Clear</u></p>  <p style="text-align: center;">1400mm long</p>	<p style="text-align: center;">Extended Bottom Door Seal 10mm Glass G/FS02/2.1/CLE</p> <p style="text-align: center;"><u>Clear</u></p>  <p style="text-align: center;">2100mm long</p>	<p style="text-align: center;">Glass To Glass 135 deg Seal 10mm Glass G/FS03/2.1/CLE</p> <p style="text-align: center;"><u>Clear</u></p>  <p style="text-align: center;">2100mm long</p>	<p style="text-align: center;">Glass To Glass 180 deg Seal 10mm Glass G/FS04/2.1/CLE</p> <p style="text-align: center;"><u>Clear</u></p>  <p style="text-align: center;">2100mm long</p>
<p style="text-align: center;">Bulb Door Seal 10mm Glass G/FS05/2.1/CLE</p> <p style="text-align: center;"><u>Clear</u></p>  <p style="text-align: center;">2100mm long</p>	<p style="text-align: center;">Sliding Door Seal 10mm Glass G/FS06/2.1/CLE</p> <p style="text-align: center;"><u>Clear</u></p>  <p style="text-align: center;">2100mm long</p>	<p style="text-align: center;">Glass To Glass 90 deg Seal 10mm Glass G/FS07/2.1/CLE</p> <p style="text-align: center;"><u>Clear</u></p>  <p style="text-align: center;">2100mm long</p>	

Juralco Frameless Shower Systems - Components

Codes	Finishes
BB	Brushed Brass
BG	Brushed Gold
BN	Brushed Nickel

Codes	Finishes
BRG	Brushed Rose Gold Copper
CP	Polished Chrome
GM	Brushed Gun Metal
MB	Matt Black

Codes	Finishes
NAT	Natural Anodised
PSS	Polished SS
SB	Satin Brass
SCC	Powder Coated

Codes	Finishes
SCP	Satin Chrome
SN	Brushed Satin Nickel
SSS	Satin SS
STE	Sterling Bright Anodised

Shower Brace Components

Shower Brace Rod
19mm dia x 1mm
G/SBR/19DX1200
G/SBR/19DX600
G/SBR/19DX100

Finishes All - PSS, SSS, SCC

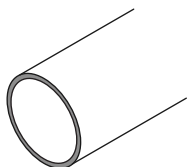

Lengths. 1200,600 and 100mm

Shower Brace to Wall
- Adjustable Bracket.
- 19mm dia Tube
G/SBR/01

Finishes CP, SCP, SCC

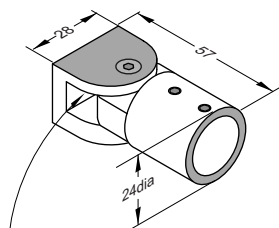

1x10x38 C/S screw

Shower Brace to 10mm Glass
- Adjustable Bracket.
- 19mm dia Tube
G/SBR/02

Finishes CP, SCP, SCC

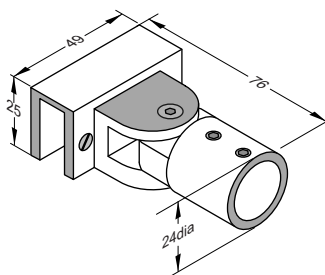

Shower Brace to 10mm Glass
- Inline Bracket.
- 19mm dia Tube
G/SBR/03

Finishes CP, SCP, SCC

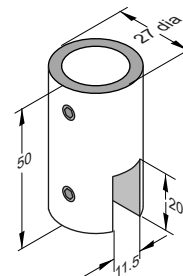

Shower Brace to
- Ceiling or Floor.
- 19mm dia Tube
G/SBR/04

Finishes CP, SCP, SCC

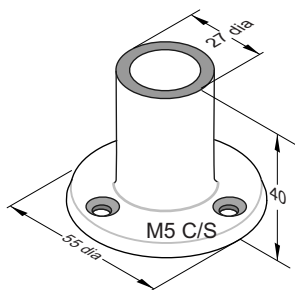

Shower Brace
Wall Fix Bracket
JSS/WFB

Finishes: PSS, SSS, BN, MB, GM, SB, BG

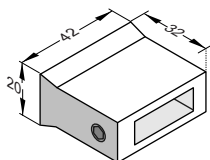

Rail to Glass 90deg
End Brace
- Bracket to 10mm Glass
- 30x 10mm Tube
G/GBR/RGB

Finishes PSS, SCC

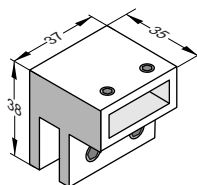

Rail to Glass Extended 90deg
- End Brace to 10mm Glass
- 30 x 10mm Tube
G/GBR/RGE

Finishes PSS, SCC

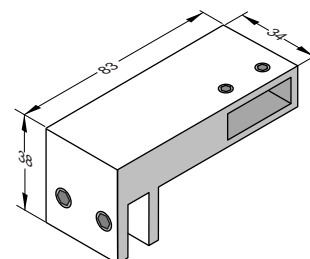

Rail

Rail 30 x 10mm
JSS/RAIL/1000

Finishes PSS, SCC

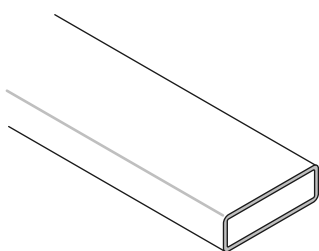

Length. 1000mm

Hinge Fixing Plates

Fixing Plate
for Hinge JH1

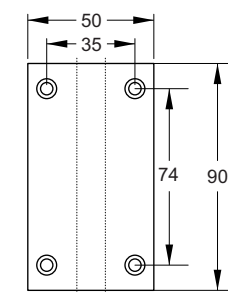

Approx Glass Lines

Fixing Plate
for Hinge JH1/L3

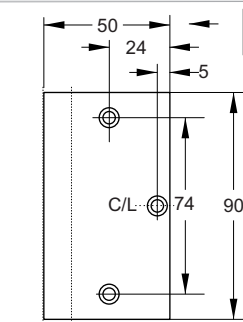

Approx Glass Lines

Juralco Frameless Shower Systems - Components

Codes	Finishes
BB	Brushed Brass
BG	Brushed Gold
BN	Brushed Nickel

Codes	Finishes
BRG	Brushed Rose Gold Copper
CP	Polished Chrome
GM	Brushed Gun Metal
MB	Matt Black

Codes	Finishes
NAT	Natural Anodised
PSS	Polished SS
SB	Satin Brass
SCC	Powder Coated

Codes	Finishes
SCP	Satin Chrome
SN	Brushed Satin Nickel
SSS	Satin SS
STE	Sterling Bright Anodised

Shower Brace Sets

Shower Brace Rod Set
 - Wall to 10mm Glass,
 - 19mm dia Tube, 1200mm
 - Swivel Bracket
 - Adjustable length
 G/SBR/1200

Finishes: PSS, SSS, SCC

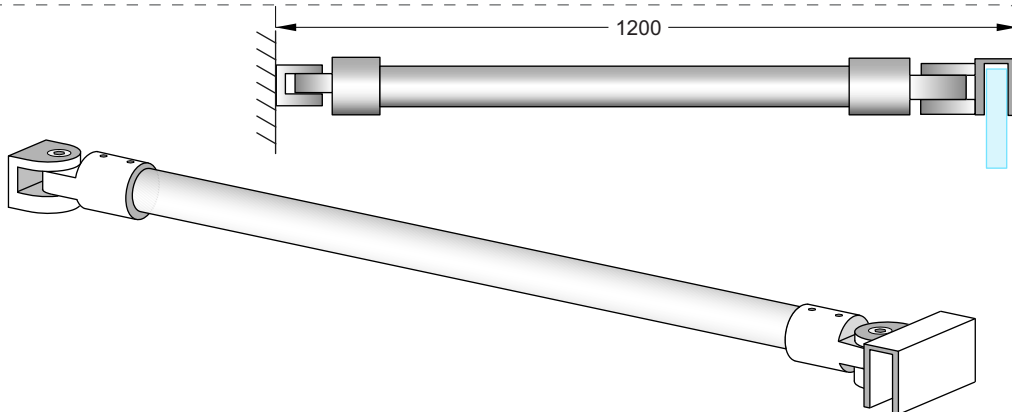

Shower Brace Rod Set
 - Wall to 10mm Glass,
 - 30x10mm Rail 1000mm
 - Fixed Bracket
 - Adjustable length
 G/SBS/1000/

Finishes: PSS, SSS, SCC

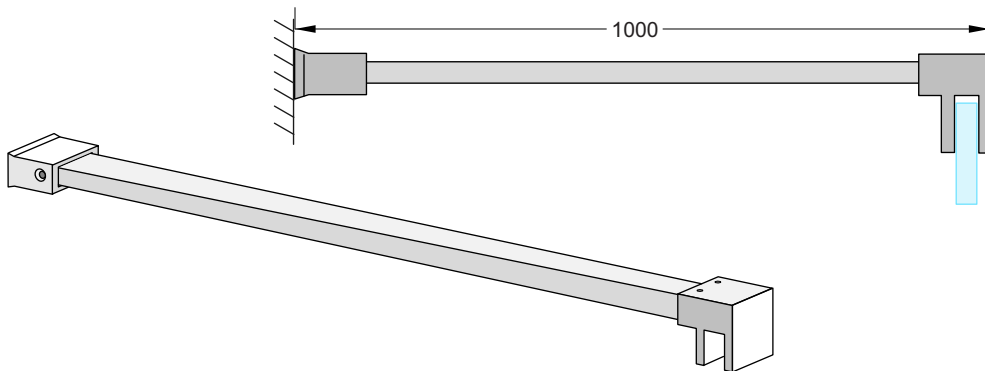

Shower Ceiling Brace Rod Set
 - 19mm dia Tube, 600mm
 - Adjustable length
 G/SCBR/600

Finishes: PSS, SSS, SCC

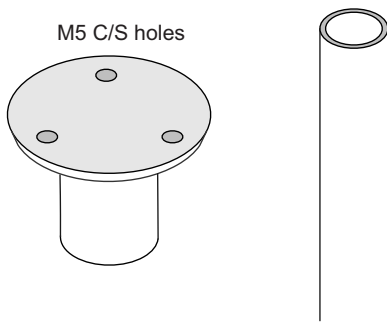

Shower Brace to Ceiling
 - 19mm dia Tube
 G/SBR/04

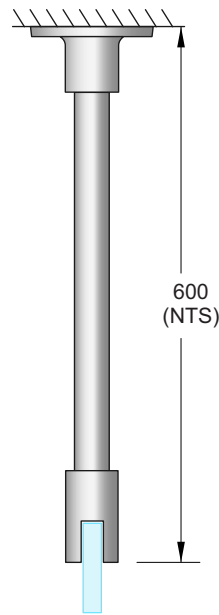

Shower Brace
 10mm Glass
 - Inline Bracket.
 - 19mm dia Tube
 BR/03

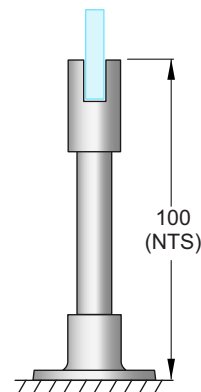

Shower Brace to Floor.
 - 19mm dia Tube
 G/SBR/04

Shower Floor Brace Rod Set
 - 19mm dia Tube, 100mm
 - Adjustable length
 G/SFBR/100

Finishes: PSS, SSS, SCC

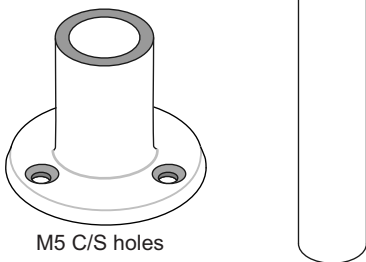

Shower Brace
 10mm Glass
 - Inline Bracket.
 - 19mm dia Tube
 BR/03

Juralco Frameless Shower Systems - Cutouts

Glass to Wall Hinge Centered JH1

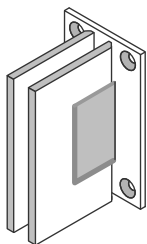

Glass to Wall Hinge Offset JH1/L3

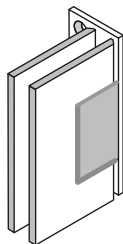

Glass Cutouts, Both Hinges

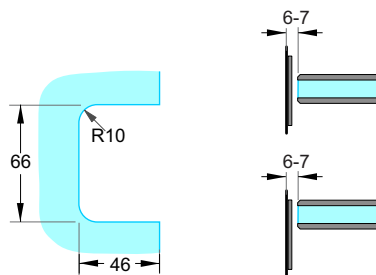

Glass to Glass Hinge 180deg JH2

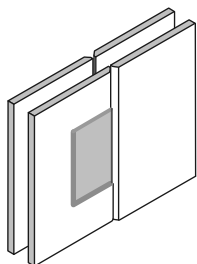

Glass Cutouts JH2

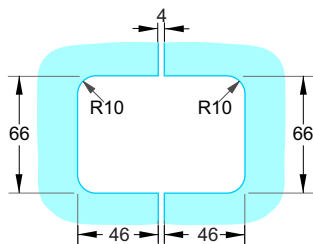

Glass to Glass Hinge 135 deg JH2/135

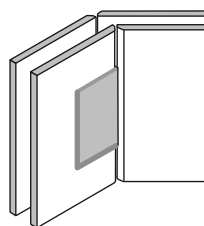

Glass Cutouts JH2/135

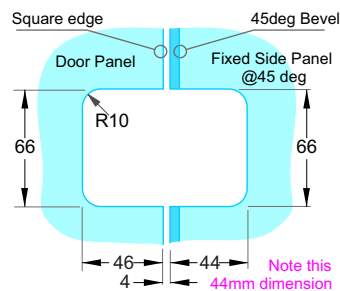

Glass to Glass Hinge Bifold JH2/BF

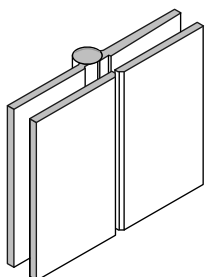

Glass Cutouts JH2/BF

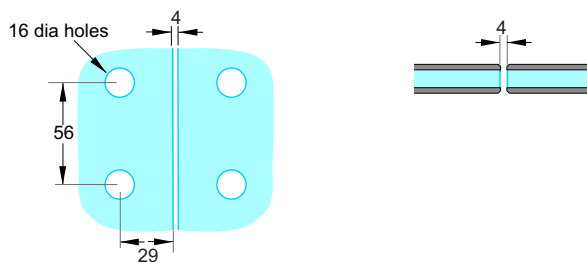

Glass to Glass Hinge 90deg JH2/90

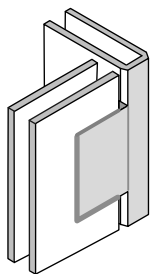

Glass Cutouts JH2/90

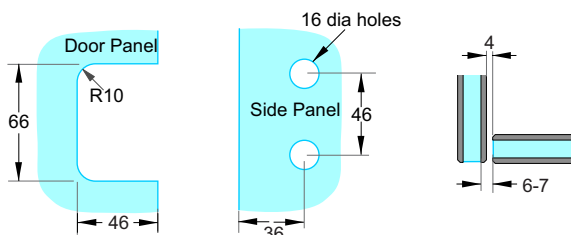

Back to Glass Hinge 90deg JH3/90

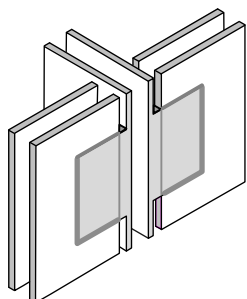

Glass Cutouts JH3/90

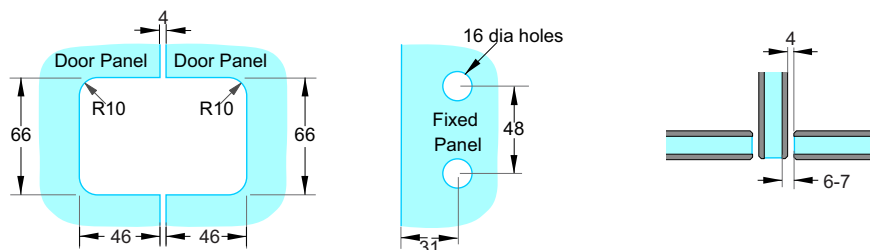

Juralco Frameless Shower Systems - Components

Shower Door Privacy Latches

G/IL600C/SSS. Hinged Glass Door to Wall. Includes Keeper (No glass cutout required)

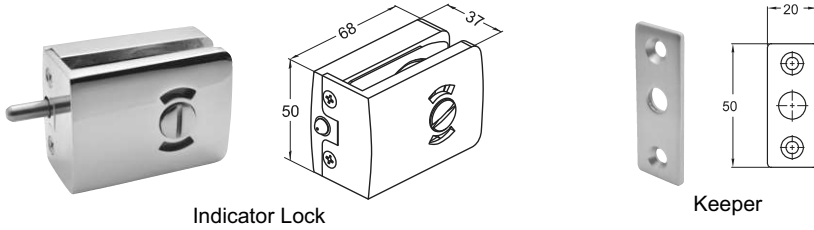

Indicator Lock

Keeper

G/IL700C/SSS and PSS. Hinged Glass Door to Wall. Includes Keeper (Glass cutout required)

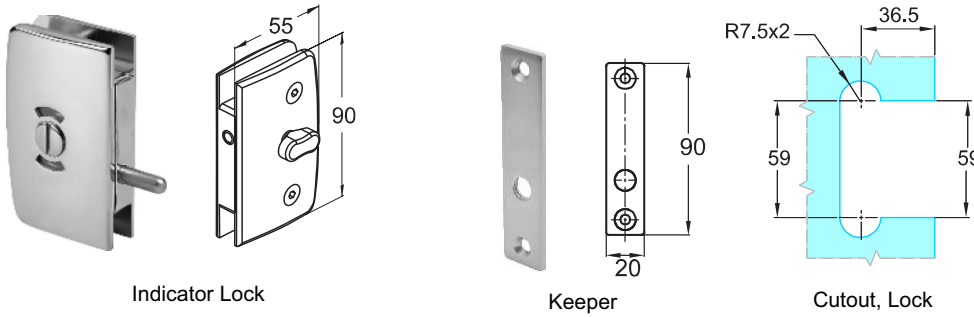

Indicator Lock

Keeper

Cutout, Lock

G/IL701C/SSS and PSS. Hinged Glass Door to Glass Side Panel. Includes Keeper (Glass cutout required)

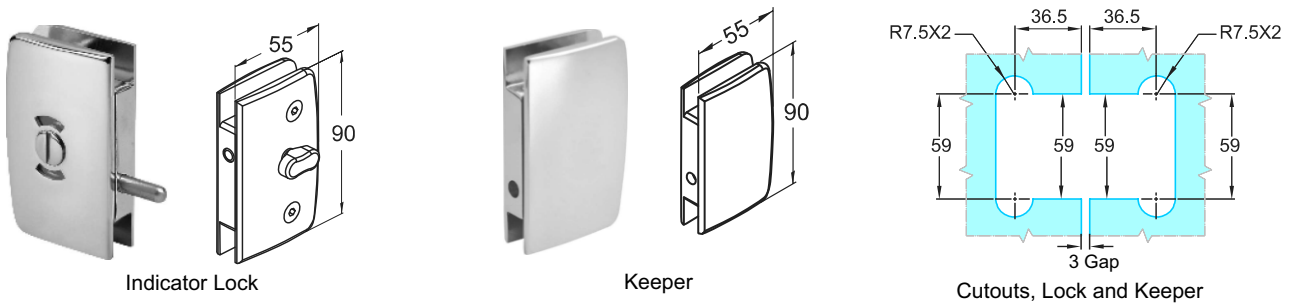

Indicator Lock

Keeper

Cutouts, Lock and Keeper

G/IL700C-H/SSS and PSS. Sliding Glass Door to Wall. Includes Keeper (Glass cutout required)

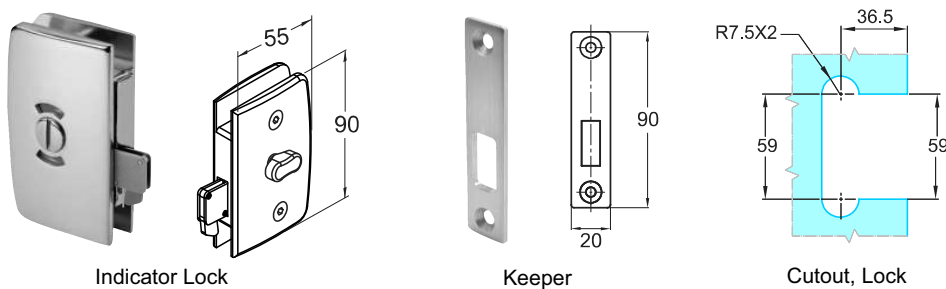

Indicator Lock

Keeper

Cutout, Lock

G/IL701C-H/SSS and PSS. Sliding Glass Door to Glass Side Panel. Includes Keeper (Glass cutout required)

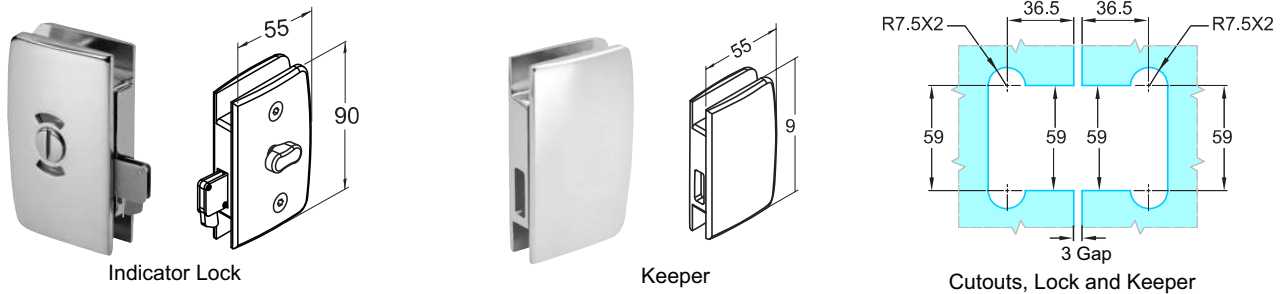

Indicator Lock

Keeper

Cutouts, Lock and Keeper

Juralco Frameless Shower Systems - Measuring, Typical Sections

Measuring

- Measure twice, cut once!
- For doors hinged directly from the wall adequate stud fixings are required. Either a double stud or a 90mm width of timber fitted between nogs at hinge level is required.
- Where inadequate wall fixing is suspected or penetration of Waterproofing isn't an option it is recommended the door be hinged from a glass sidelight panel.
- For shower enclosures with return panels, establish points at corners where outside line of the Glass will finish. Measure to these points. Small off-cuts of channel sections are useful to assist in determining where shower the enclosure is to finish. This is especially true for the 45 deg return panel type..
- Measure and take note of all out of square situations. If necessary take a pattern of shape and mark all straight lines on pattern.
- For sloped floors deduct 5mm from door height measured at the highest point of the complete door swing area.
- For out of plumb situations it is often best to measure and fit the glass side panel/s (which will have been cut to provide a true perpendicular edge from which to hinge the door) first and remeasure the remaining door opening before toughening and fitting the door.
- Height normally 1900mm.

Typical Layout, Components

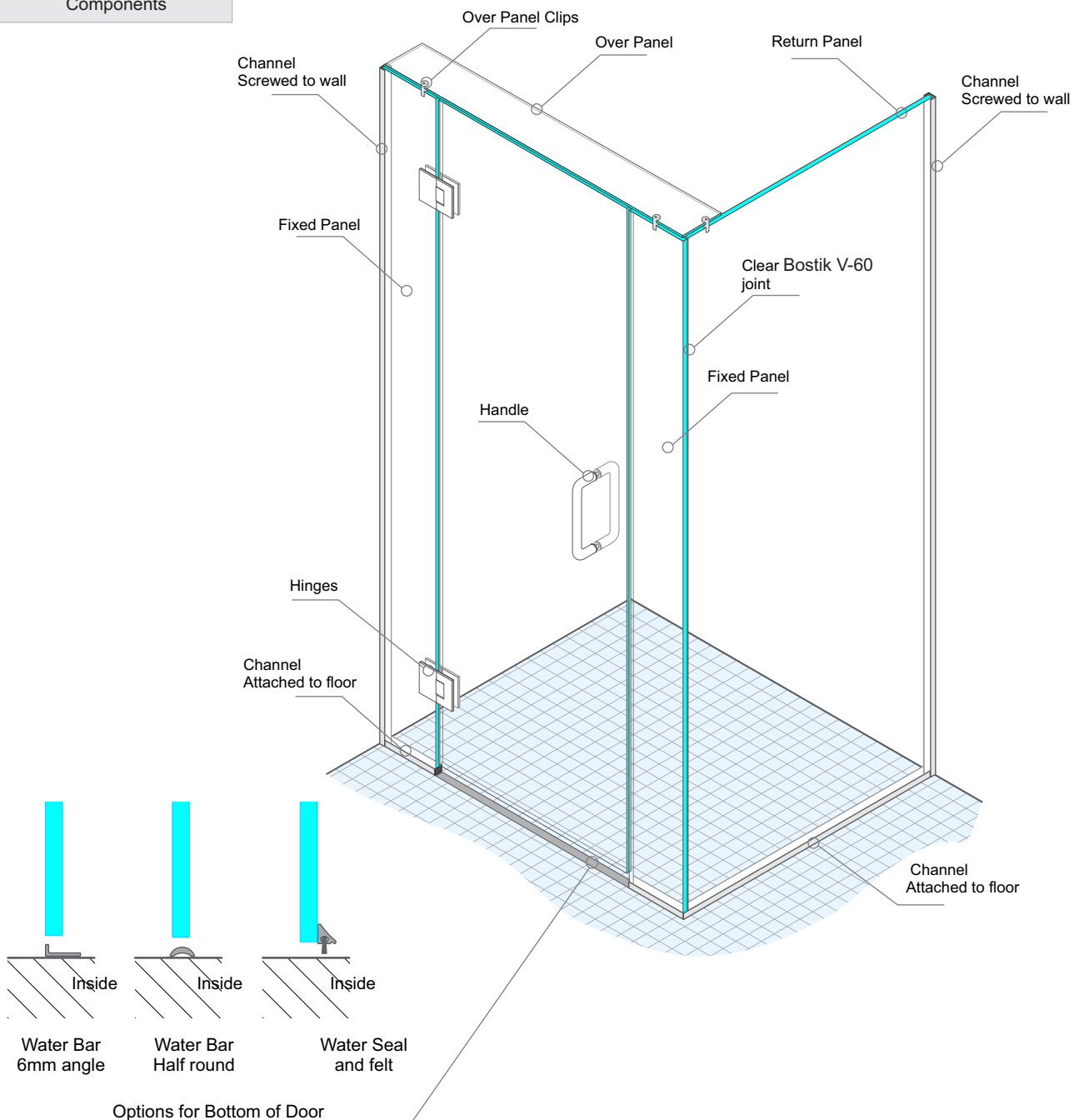

Juralco Frameless Shower Systems - Hinged Cutting Allowances

Glass Cutting Height Allowances

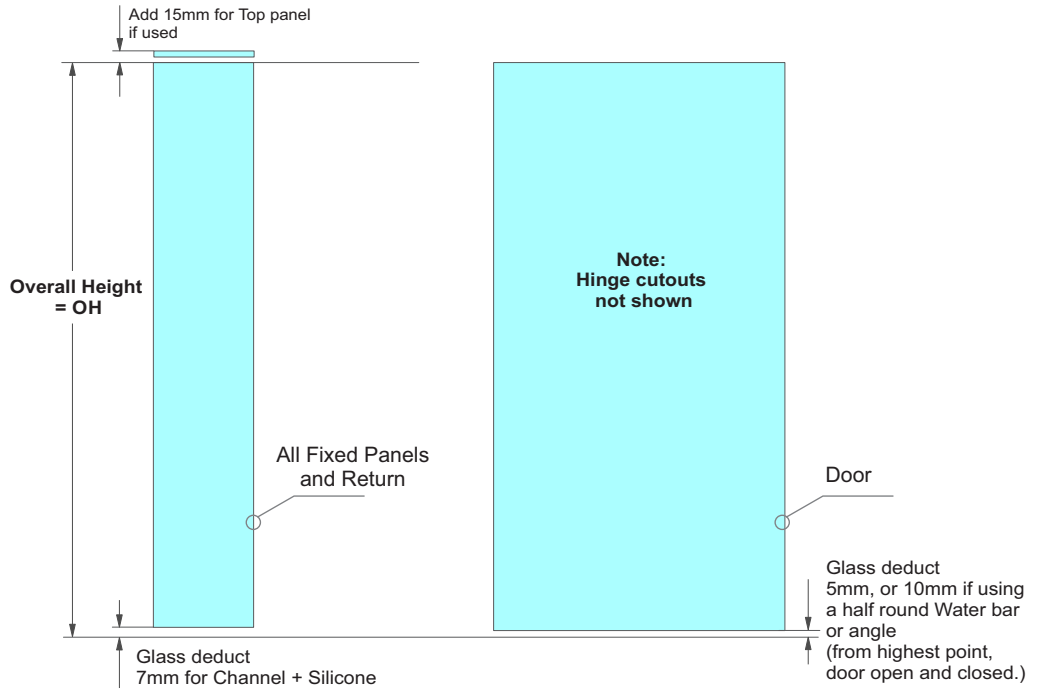

Glass Cutting Width Allowances

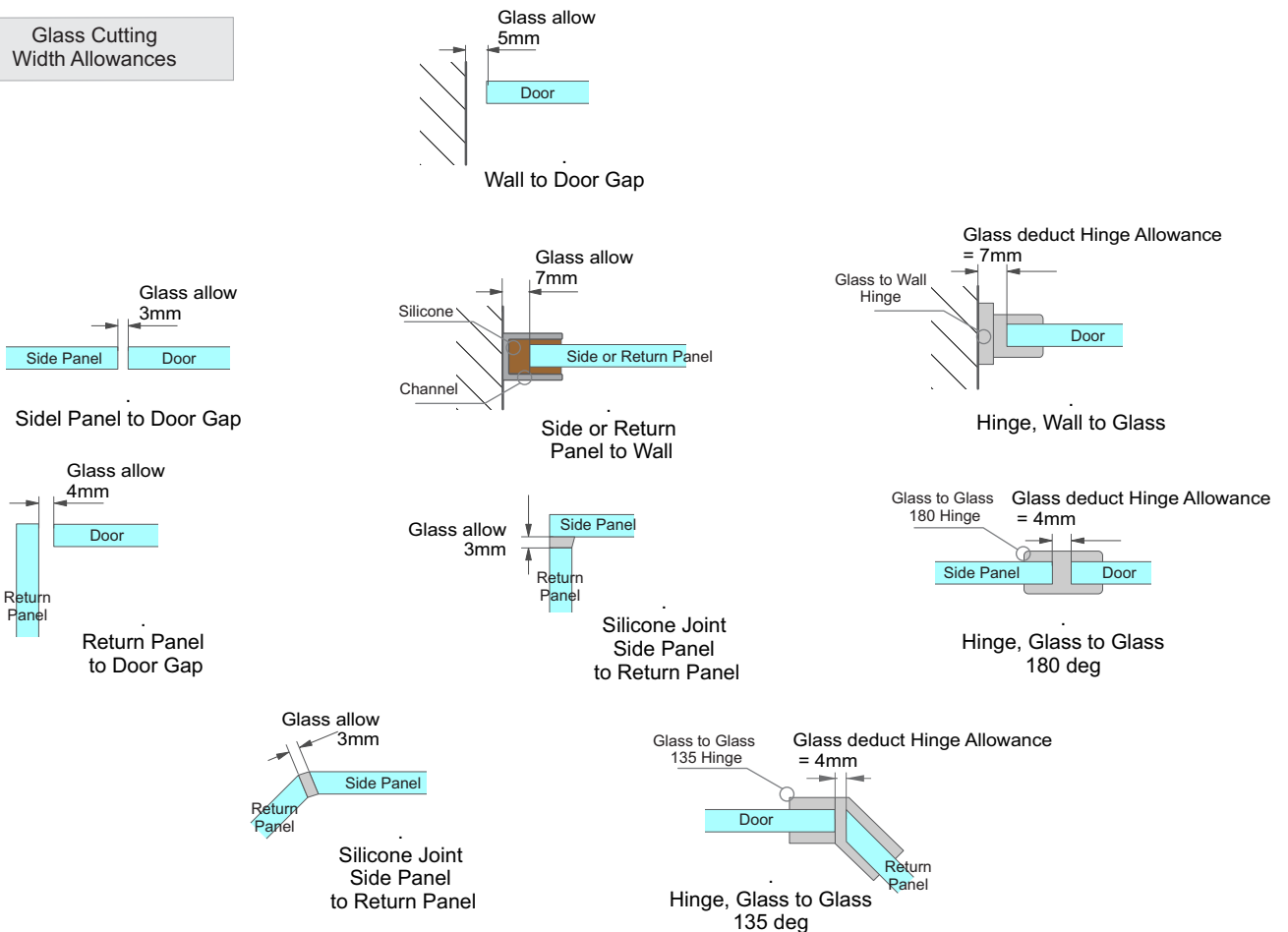

Juralco Frameless Shower Systems - Cutting

Between Walls Cutting. Glass 10mm

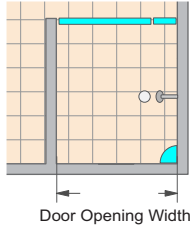

A 10mm Glass
Glass to Glass 180 Hinge
1 x Door,
2 x Sidelights
1 x Overpanel



Opening Width range
1000 - 1250+mm

B 10mm Glass
Wall to Glass Hinge
1 x Door,
1 x Sidelight



Opening Width range
800 - 1100mm

C 10mm Glass
Glass to Glass 180 Hinge
1 x Door,
1 x Sidelight
1 x Overpanel



Opening Width range
850 - 1100mm

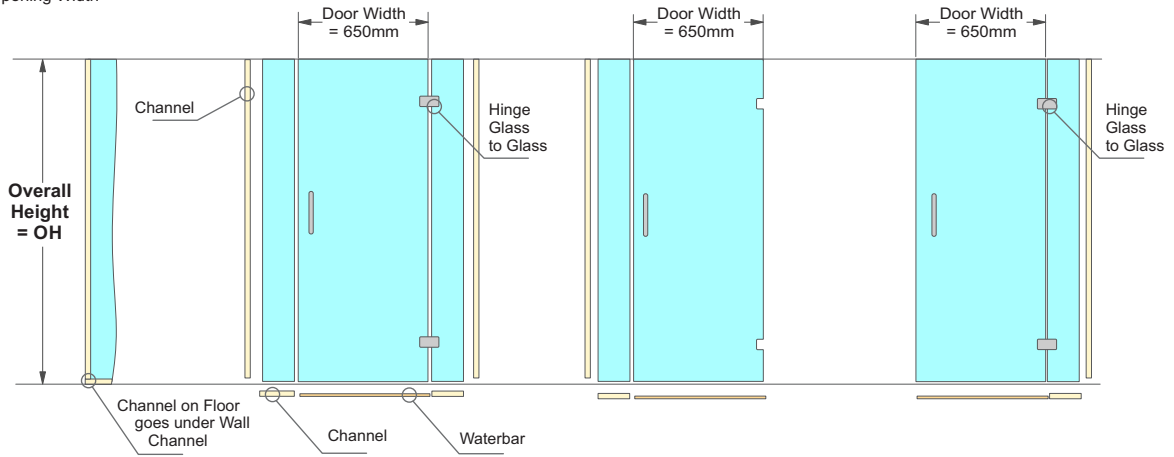

Note 1 - All these width cutting formula assume Door width = 650mm

Shower between Walls - Heights

Heights	Item	Dimension
Overall Height		OH
Glass Door (No Waterbar)	10mm Glass	OH-5
Glass Door (Waterbar)		OH-10
Glass Side Panel		OH-7
Channel	H/970	OH-18

Option A - Shower between Walls - Widths

Widths	Item	Dimension
Opening Width - 1000mm		OW
Glass Door	10mm Glass	650
Glass Side Panels (100mm min)		$(OW-670)/2$
Channel	H/970	$(OW-663)/2$
Water Bar (clearance for End Caps)	H/970	654

Option B - Shower between Walls - Widths

Widths	Item	Dimension
Opening Width - 1000mm		OW
Glass Door	10mm Glass	650
Glass Side Panels (100mm min)		OW-667
Channel	H/970	OW-660
Water Bar (clearance for End Caps)	H/970	659

Option C - Shower between Walls - Widths

Widths	Item	Dimension
Opening Width - 1000mm		OW
Glass Door	10mm Glass	650
Glass Side Panels (100mm min)		OW-665
Channel	H/970	OW-658
Water Bar (clearance for End Caps)	H/970	657

Juralco Frameless Shower Systems - Cutting

Door and 90deg Return
Cutting. **Glass 10mm**

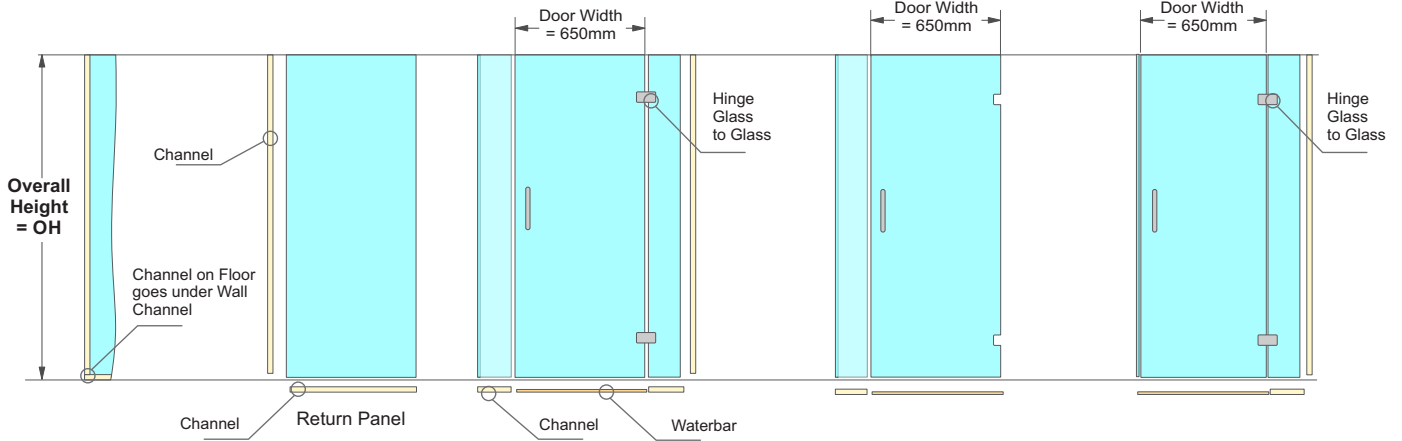
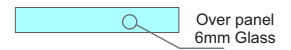
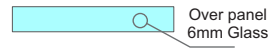
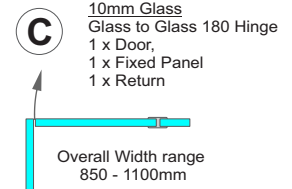
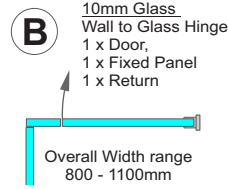
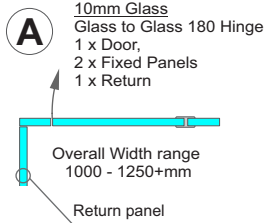
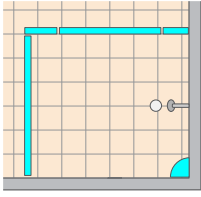

Note 1 - All these width cutting formula assume Door width = 650mm

Shower with 90deg Return - Heights

Heights	Item	Dimension
Overall Height		OH
Glass Door (No Waterbar)	10mm Glass	OH-5
Glass Door (with Waterbar)		OH-10
Glass Side Panel		OH-7
Glass Return Panel		OH-7
Channel	H/970	OH-18

All Options - Return Panel - Widths

Widths	Item	Dimension
Return Width		RW
Glass Return Panel (A&B options)	10mm Glass	RW-16
Channel, miter corner (A&B options)	H/970	RW+7
Glass return Panel (C option)	10mm Glass	RW-7
Channel, sq end (C option)	H/970	RW

Option A - Shower 90deg return - Widths

Widths	Item	Dimension
Opening Width - 1000mm		OW
Glass Door	10mm Glass	650
Glass Side Panels (100mm min)		$(OW-670)/2$
Channel, Side Panel A, sq ends	H/970	$(OW-670)/2+7$
Channel, Side Panel B, 1 x miter end	H/970	$(OW-656)/2+7$
Water Bar	975,978	654
Over Panel. Width x Depth	6mm	$(OW-5) \times 150$

Option B - Shower 90deg return - Widths

Widths	Item	Dimension
Opening Width - 1000mm		OW
Glass Door	10mm Glass	650
Glass Side Panel (100mm min)		OW-660
Channel, Side Panel B, 1 x miter end	H/970	OW-653
Water Bar	975,978	659
Over Panel. Width x Depth	6mm	$(OW-5) \times 150$

Option C - Shower 90deg return - Widths

Widths	Item	Dimension
Opening Width - 1000mm		OW
Glass Door	10mm Glass	650
Glass Side Panel (100mm min)		OW-670
Channel, Side Panel B, 1 x miter end	H/970	OW-663
Water Bar	975,978	655
Over Panel. Width x Depth	6mm	$(OW-5) \times 150$

Juralco Frameless Shower Systems - Cutting

Door and 45deg Returns
Cutting. **Glass 10mm**

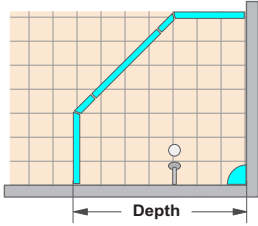
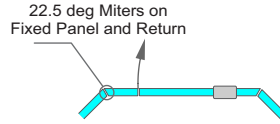

Table showing Theoretical Return Width = RW

Depth	Door + Sidelights = OW				
	800	900	1000	1100	1200
800	234	164	NA	NA	NA
900	334	264	193	NA	NA
1000	434	364	293	222	152
1100	534	464	393	322	252
1200	634	564	493	422	352
1300	734	664	593	522	452
1400	834	764	693	622	552

A 10mm Glass
Glass to Glass 180 Hinge
1 x Door, 2 x Fixed Panels
2 x Returns
1 x Overpanel



B 10mm Glass
Wall to Glass 135 Hinge
1 x Door, 1 x Fixed Panel
2 x Returns
1 x Overpanel

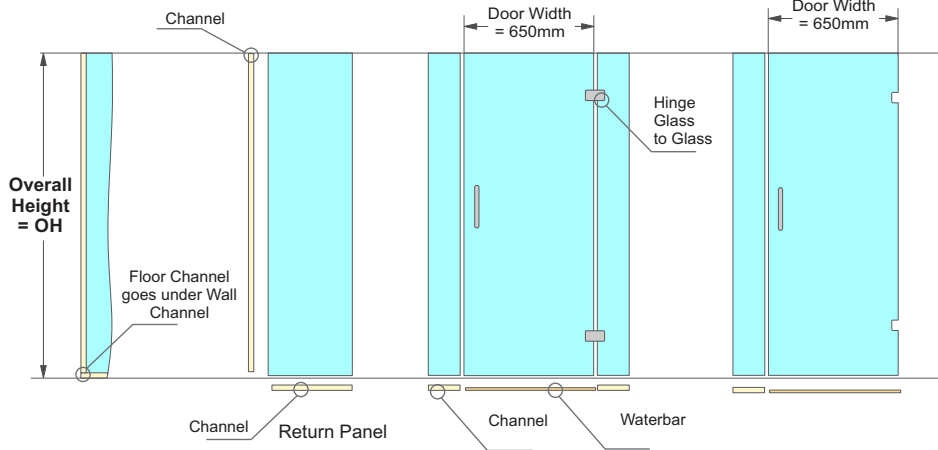
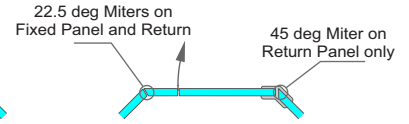

Note 1 - All these width cutting formula assume Door width = 650mm

Shower with 2 x 45deg Returns - Heights

Heights	Item	Dimension
Overall Height		OH
Glass Door (No Waterbar)	10mm Glass	OH-5
Glass Door (Waterbar)		OH-10
Glass Side Panel		OH-7
Glass Return Panel		OH-7
Channel Side and Return Panels	H/970	OH-18

Option A - Shower 2 x 45deg Returns - Widths

Widths	Item	Dimension
Opening Width - 1000mm		OW
Glass Door	10mm Glass	650
Glass Side Panels (100mm min)		(OW-658)/2
Channels, Side Panels, (1 x miter end)	H/970	(OW-658)/2+3
Water Bar (clearance for End caps)	975,978	654
Over Panel Lozenge Width x Depth	6mm	(OW+300) x 150
Return Widths	975,978	RW
Glass Return Panels	10mm	RW-8
Channel, Return (1 x Miter end)	3877	RW+3

Option B - Shower 2 x 45deg Returns - Widths

Widths	Item	Dimension
Opening Width - 1000mm		OW
Glass Door	10mm Glass	650
Glass Side Panels (100mm min)		OW-667
Channels, Side Panels, (1 x miter end)	H/970	OW-664
Water Bar (clearance for End caps)	975,978	654
Over Panel Lozenge Width x Depth	6mm	(OW+300) x 150
Return Widths	975,978	RW
Glass Return Panels	10mm	RW-8
Channel, Return A (1 x Miter end)	3877	RW+3
Channel, Return B (1 x Miter end)	3877	RW+7

Juralco Frameless Shower Systems - Over Panels

Over Panels

- All Over panels, 6mm or 10mm Toughened Glass, polish all edges
- All 150mm deep
- See Components page for a variety of Over Panel and Glass Shelf brackets

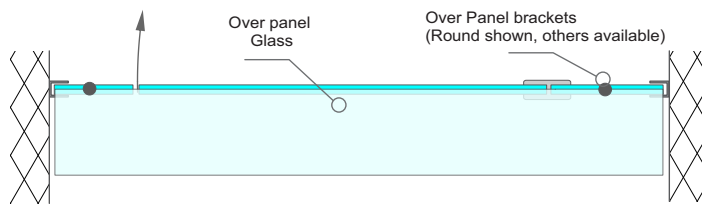

- 1 x Door, 2 x Side Panels to Walls
- Between Walls mount

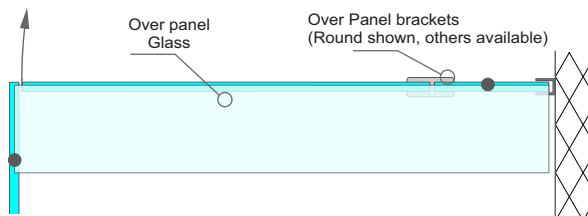

- 1 x Door, 1 x Side Panel to Wall
- 1 x 90 deg Return

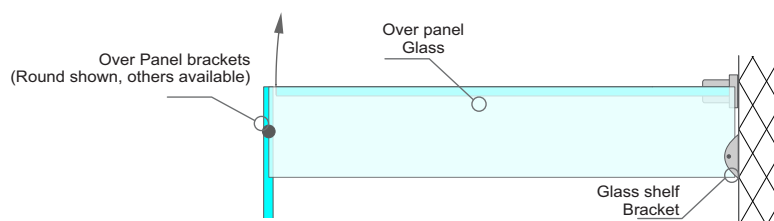

- 1 x Door
- 1 x 90 deg Return

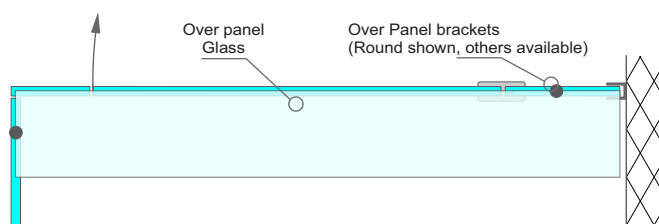

- 1 x Door, 1 x Side Panel to Wall
- + 1 x Fixed Panel
- 1 x 90 deg Return

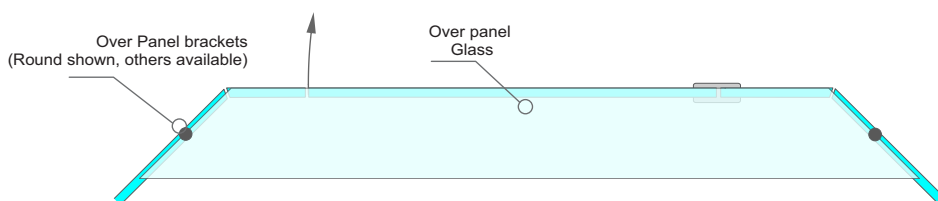

- 1 x Door, 2 x Sidelights
- 2 x 45 deg Returns

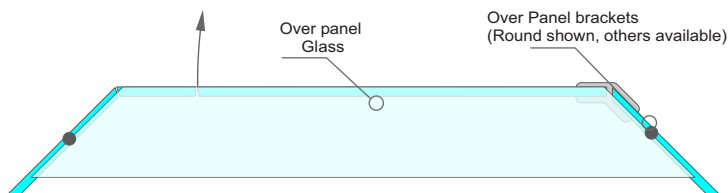

- 1 x Door, 1 x Side Panels
- 2 x 45 deg Returns
- Hinge 135

Juralco Frameless Shower Systems - Bath Screens - Measuring, Typical Sections

Measuring

- Measure twice, cut once!
- Bath screens 10mm toughened Glass
- For doors hinged directly from the wall adequate stud fixings are required. Either a double stud or a 90mm width of timber fitted between nogs at hinge level is required.
- Where inadequate wall fixing is suspected it is recommended the door be hinged from a glass side panel.
- If a Sidelight panel to wall is used, a Top Support bracket will be necessary.
- Measure and take note of all out of square situations. If necessary take a pattern of shape and mark all straight lines on pattern.
- Bath Screen Height normally 1500mm

Typical Sections, Height Allowance

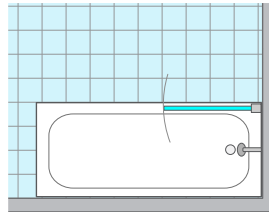

Bath Screen
Wall hung Door

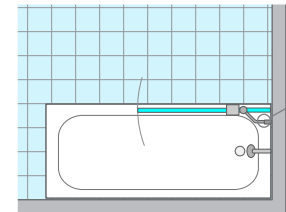

Bath Screen
Glass hung Door

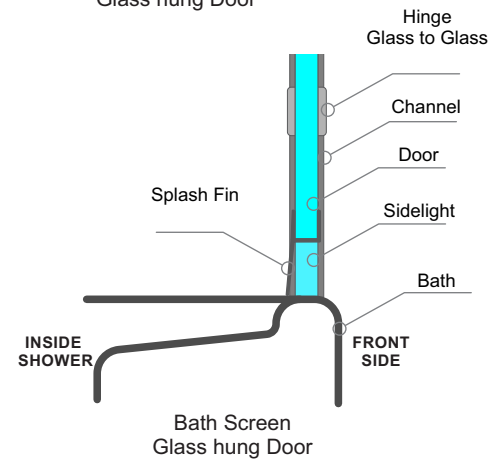
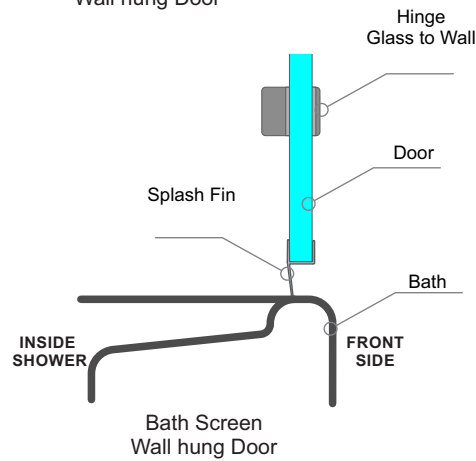
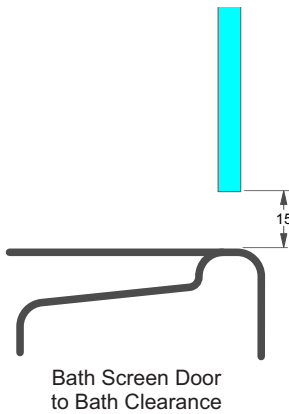

Juralco Frameless Shower Systems - Installation

Installation

Note: Prior to delivering to site, unpack and check all items

Note - Check all Glass is marked with Toughened Safety Glass Stamp

Installation

Glass to Glass Hinge Types.

- 1 - Inspect Glass and extrusions for damage. Assemble all necessary components. Ensure site is clean.
- 2 - Attach Channel H/970, (10mm Glass) to desired setout, Walls and Floor, ensuring a continuous bead of Bostik V-60 between channels and wall / floor.
- 3 - Attach waterbar to floor if allowed for
- 4 - Insert the appropriate Glass Panel. Plumb all square. Remove for silicone.
- 5 - Starting at the wall lay a full bead of Bostik V-60 into the inside face of the channels, then reinstall the glass.
- 6 - Glaze to outside with Wedge No 31 for 10mm glass.
- 7 - Clean off excess Bostik. Apply end caps to exposed channel ends.
- 8 - After installing leave for at least 7 days to develop full strength.
- 9 - Install Over panel if needed
- 10 - Install Door and Hinges, adjust to correct clearances.
- 11 - Attach Splash fin if needed.
- 12 - Clean all fingermarks, leave site clean and tidy.

Glass to Wall Hinge Type,

- 1 - Mark off Hinge positions on wall. Must be into solid timber.
- 2 - Screw hinges to wall.
- 3 - Mount Door, splash fin.
- 4 - Check operation.
- 5 - Clean all fingermarks, leave site clean and tidy

BostikV-60

Note - This supplied Architectural, structural grade Silicone must be used for Frameless Showers. Do not use normal retail clear Silicone

General

- Bostik V-60 is a one component, non-flowing, neutral cure, High modulus silicone sealant. It cures by absorption of atmospheric moisture to form a flexible and durable elastomeric sealant.
- Special Features Bostik V-60 is a premium grade neutral cure glazing silicone sealant. It has superior adhesion to painted and anodised aluminium, as well as glass.
- The thixotropic nature of this product ensures that it will not slump in typical construction joints

Conditions

- Always ensure that the surfaces to be sealed are dry and free from oil, dirt and grease.
- Use the two-wipe process for impervious substrates. Ensure the cloths are clean and changed frequently, and use a suitable solvent such as IPA or White Spirits.
- When extruding the sealant cut the nozzle to the desired width, cut the tip off the cartridge, and apply the sealant firmly to ensure good contact between the sealant and the substrate.
- Before the sealant has skinned, tool it off to ensure a good finish, and/or remove Masking Tape. Tooling off will improve the wetting out of the sealant to the substrate. Clean / wipe of excess sealant with clean cloth or polyethylene scraper.
- Bostik V-60 cures by absorbing atmospheric moisture, it will skin over in 8 minutes and cure to a depth of 9mm in 7 days.

Properties

- Skin Time 8 Minutes BS 5889
- Tack Free Time 45 Minutes ASTM C
- Tooling Time 8 Minutes ASTM C
- Sag or Slump Nil BS5889

FRAMELESS SHOWER GLASS ORDER SHEET - HINGED

① Glass Over Panel not required

③ Hinge cutouts

DELIVER TO:

.....

② Hinge cutouts normally 250mm from Top/Btm edges
 2 x Hinges, max Door Weight 40kg (10mm Glass = 1.6sqm)
 3 x Hinges, max Door Weight 60kg (10mm Glass = 2.4sqm)
 All 10mm Clear Toughened Glass

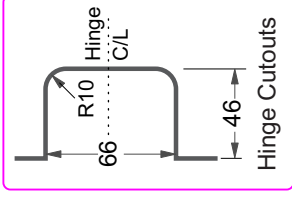

Hinge side and Dimensioning
 all Viewed from Outside Shower

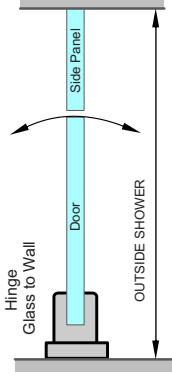

This configuration shown Below

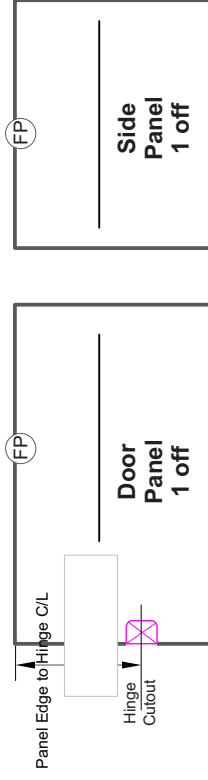

JOBNO:

.....

ORDER TO:

.....

NOTES:

.....

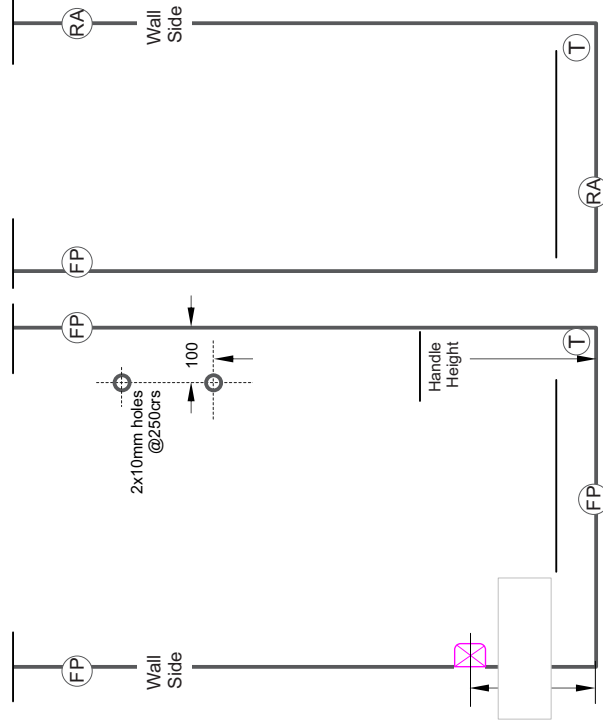

FRAMELESS SHOWER GLASS ORDER SHEET - HINGED

① Glass Over Panel not required

③ Hinge cutouts

DELIVER TO:

.....

②

Hinge cutouts normally 250mm from Top/Btm edges
 2 x Hinges, max Door Weight 40kg (10mm Glass = 1.6sqm)
 3 x Hinges, max Door Weight 60kg (10mm Glass = 2.4sqm)
 All 10mm Clear Toughened Glass

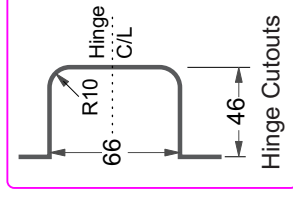

Hinge side and Dimensioning
 all Viewed from Outside Shower

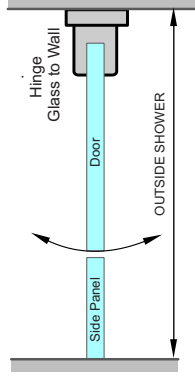

This configuration shown Below

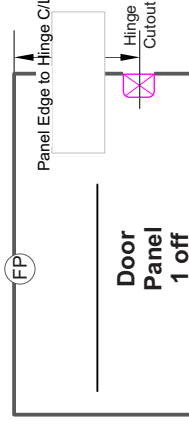
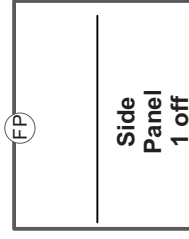

ORDER TO:

.....

NOTES:

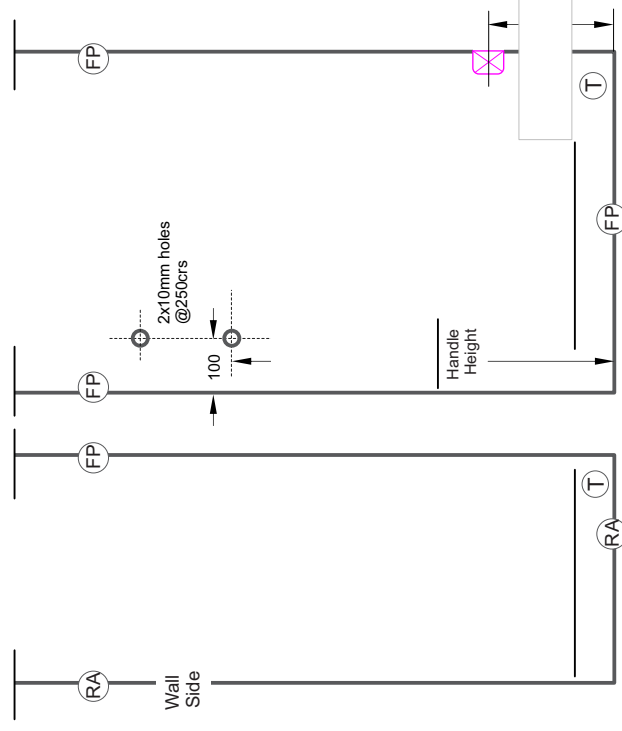

FRAMELESS SHOWER GLASS ORDER SHEET - HINGED

DELIVER TO:

.....

- 1 Glass Over Panel (if needed). Depth normally 150mm
6mm Clear Toughened Glass. All (FP) edges

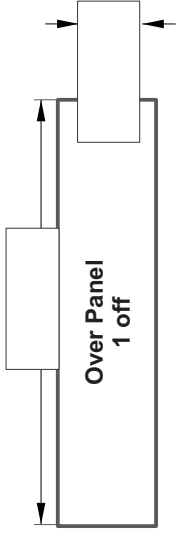

- 2 Hinge cutouts normally 250mm from Top/Btm edges
2 x Hinges, max Door Weight 40kg (10mm Glass = 1.6sqm)
3 x Hinges, max Door Weight 60kg (10mm Glass = 2.4sqm)
All 10mm Clear Toughened Glass

JOBNO:

.....

ORDER TO:

.....

NOTES:

- 3 Hinge cutouts

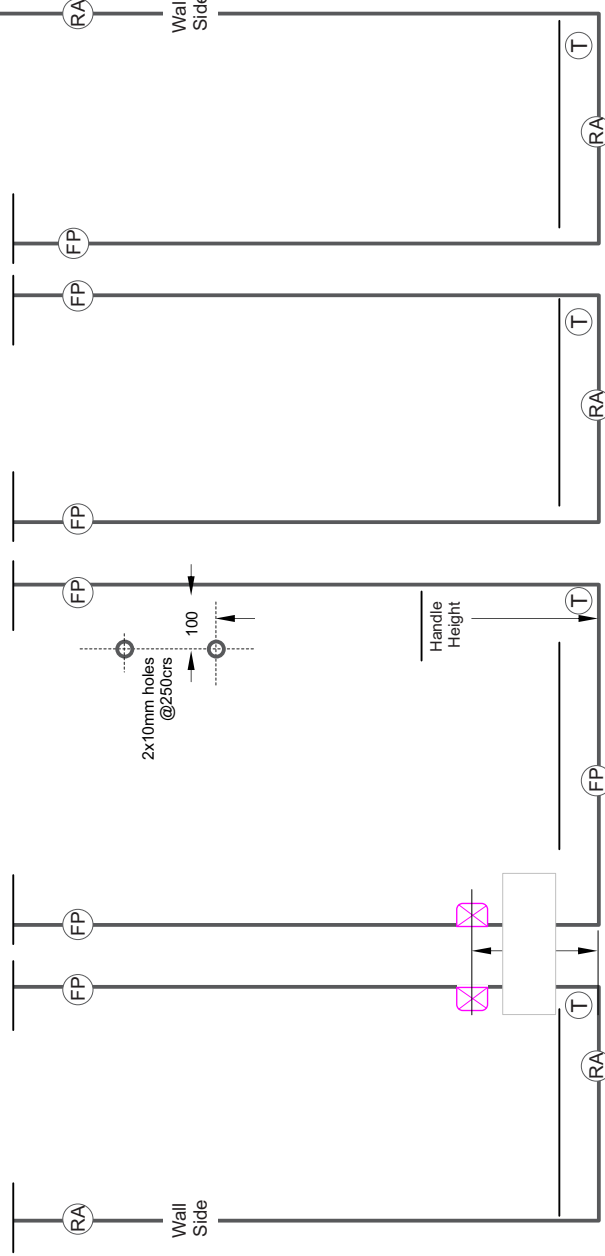
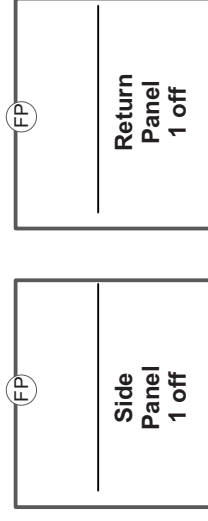
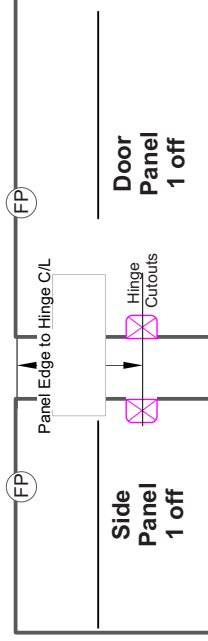
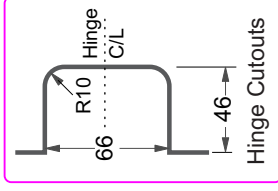

Hinge side and Dimensioning
all Viewed from Outside Shower

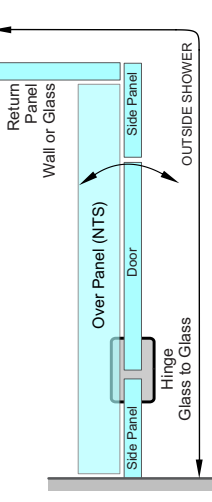

This configuration shown Below

FRAMELESS SHOWER GLASS ORDER SHEET - HINGED

DELIVER TO:

.....

JOBNO:

.....

ORDER TO:

.....

NOTES:

- 1 Glass Over Panel (if needed), Depth normally 150mm
6mm Clear Toughened Glass. All (FP) edges

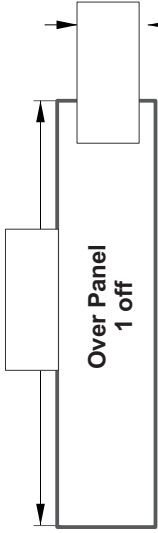

- 2 Hinge cutouts normally 250mm from Top/Btm edges
2 x Hinges, max Door Weight 40kg (10mm Glass = 1.6sqm)
3 x Hinges, max Door Weight 60kg (10mm Glass = 2.4sqm)
All 10mm Clear Toughened Glass

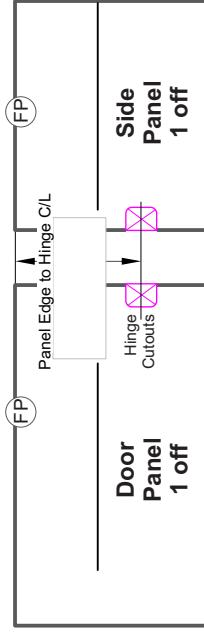
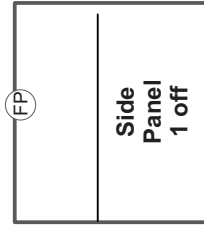
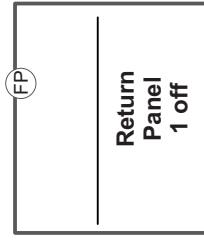

- 3 Hinge cutouts

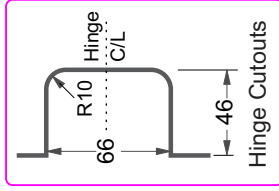

Hinge side and Dimensioning
all Viewed from Outside Shower

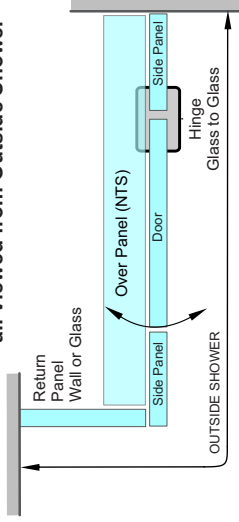

This configuration shown Below

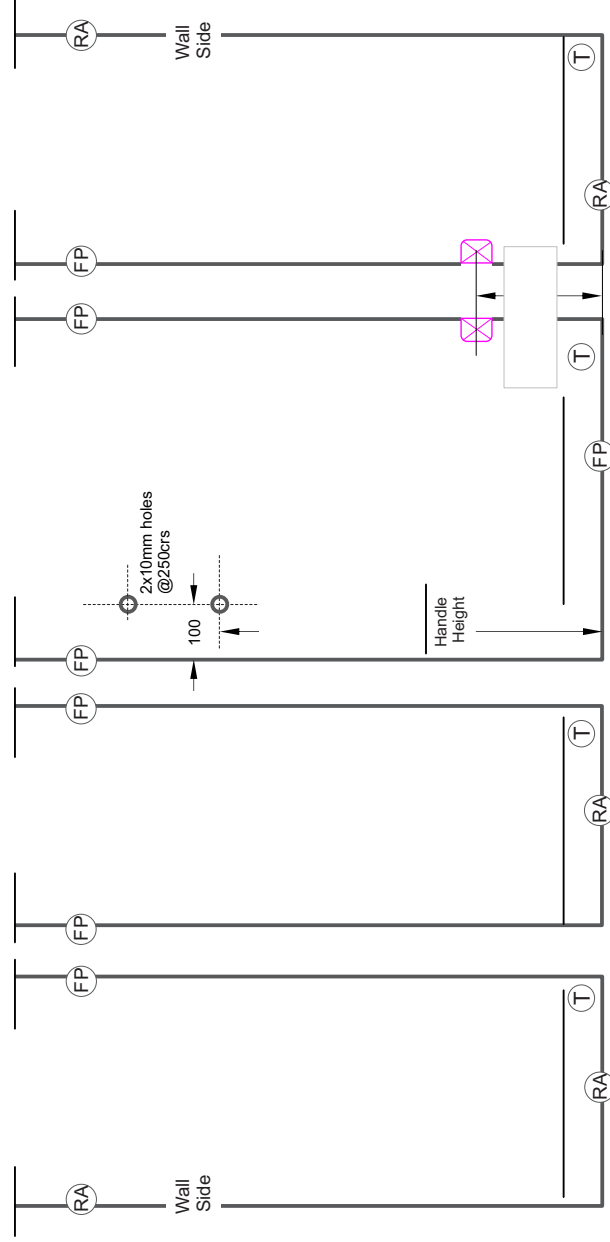

FRAMELESS SHOWER GLASS ORDER SHEET - HINGED

1 Glass Over Panel not required

3 Hinge cutouts

2 Hinge cutouts normally 250mm from Top/Btm edges
 2 x Hinges, max Door Weight 40kg (10mm Glass = 1.6sqm)
 3 x Hinges, max Door Weight 60kg (10mm Glass = 2.4sqm)
 All 10mm Clear Toughened Glass

DELIVER TO:

JOBNO:

ORDER TO:

NOTES:

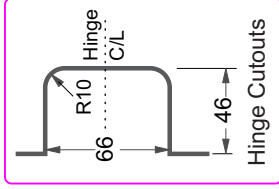

Hinge side and Dimensioning
all Viewed from Outside Shower

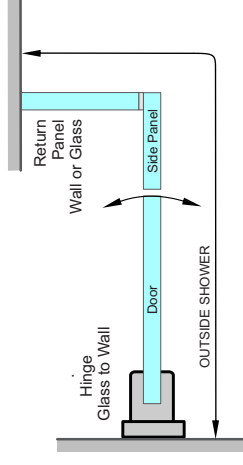

This configuration shown Below

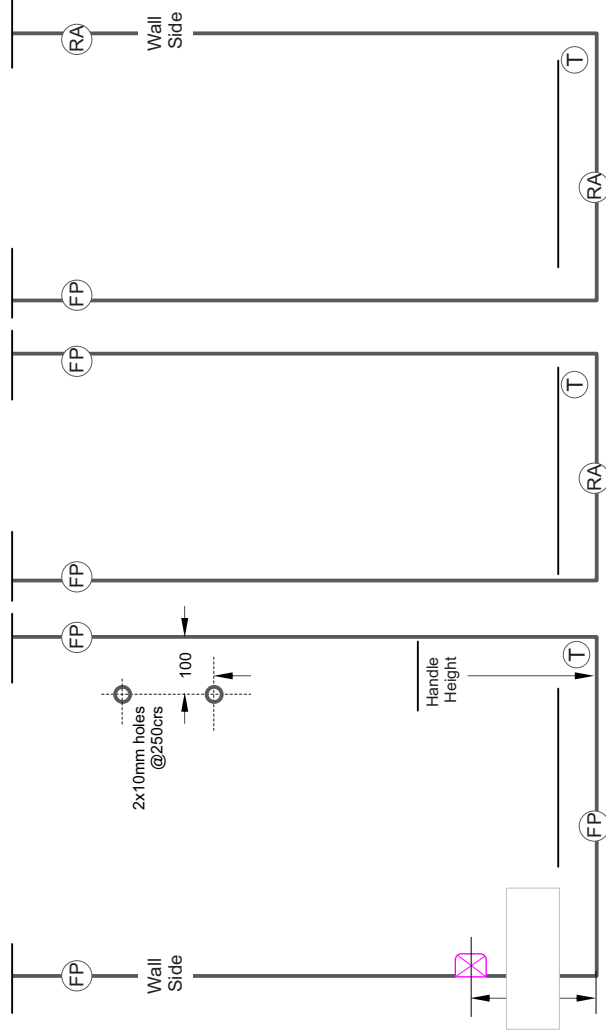
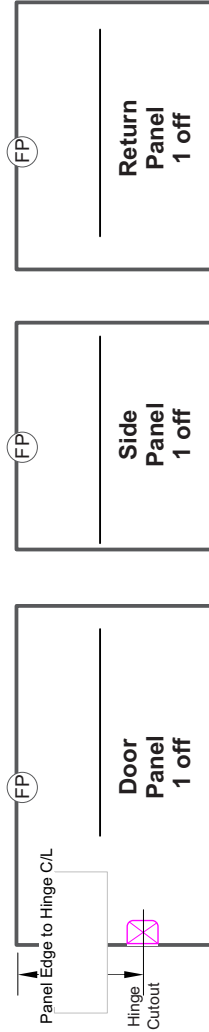

FRAMELESS SHOWER GLASS ORDER SHEET - HINGED

1 Glass Over Panel not required

3 Hinge cutouts

DELIVER TO:

.....

2

Hinge cutouts normally 250mm from Top/Btm edges
 2 x Hinges, max Door Weight 40kg (10mm Glass = 1.6sqm)
 3 x Hinges, max Door Weight 60kg (10mm Glass = 2.4sqm)
 All 10mm Clear Toughened Glass

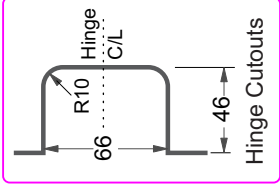

Hinge side and Dimensioning all Viewed from Outside Shower

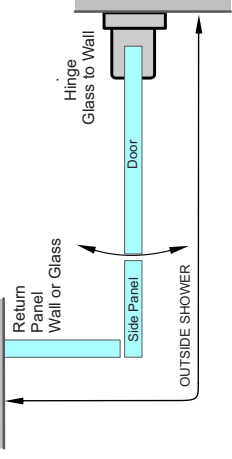

This configuration shown Below

JOBNO:

.....

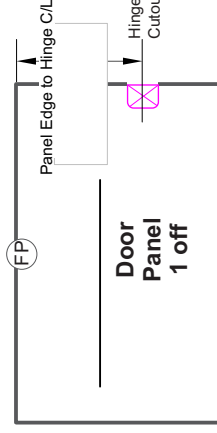
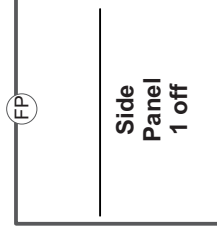
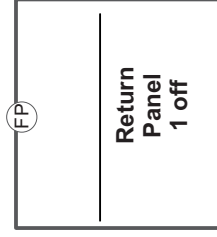

ORDER TO:

.....

NOTES:

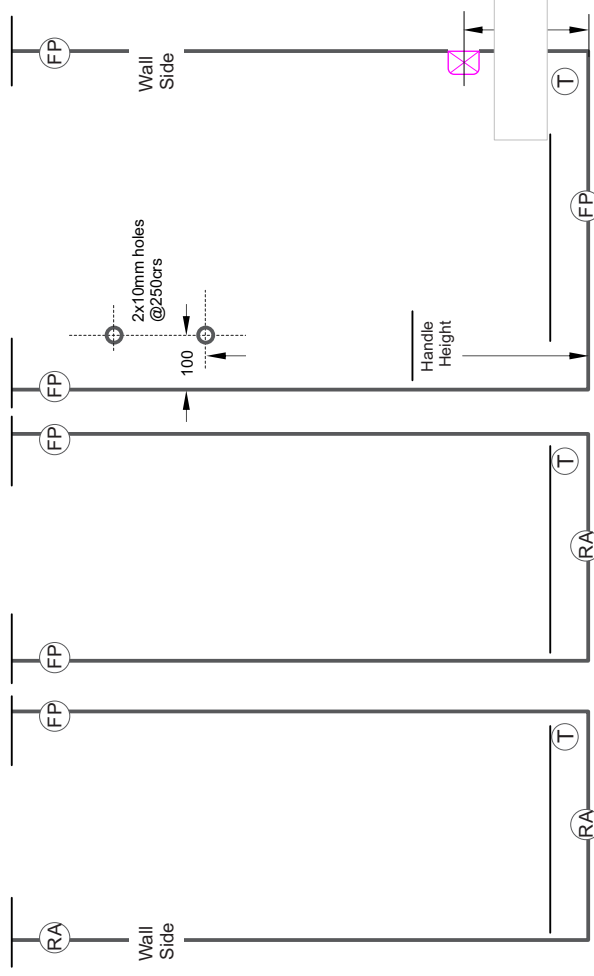

FRAMELESS SHOWER GLASS ORDER SHEET - HINGED

DELIVER TO:

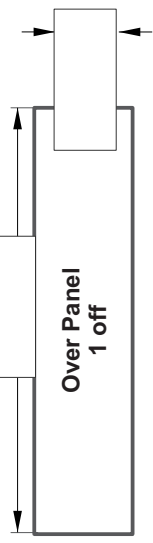

- 1 Glass Over Panel (if needed). Depth normally 150mm
6mm Clear Toughened Glass. All (FP) edges

- 2 Hinge cutouts normally 250mm from Top/Btm edges
2 x Hinges, max Door Weight 40kg (10mm Glass = 1.6sqm)
3 x Hinges, max Door Weight 60kg (10mm Glass = 2.4sqm)
All 10mm Clear Toughened Glass

JOBNO:

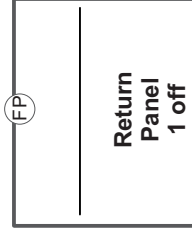
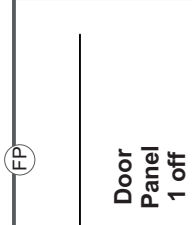
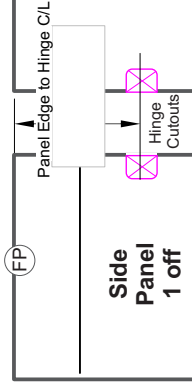

- 3 Hinge cutouts

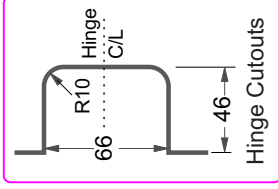

**Hinge side and Dimensioning
all Viewed from Outside Shower**

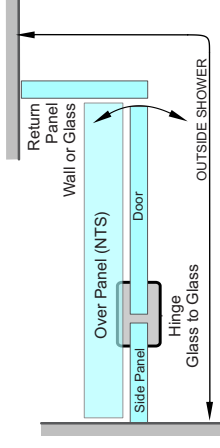

This configuration shown Below

ORDER TO:

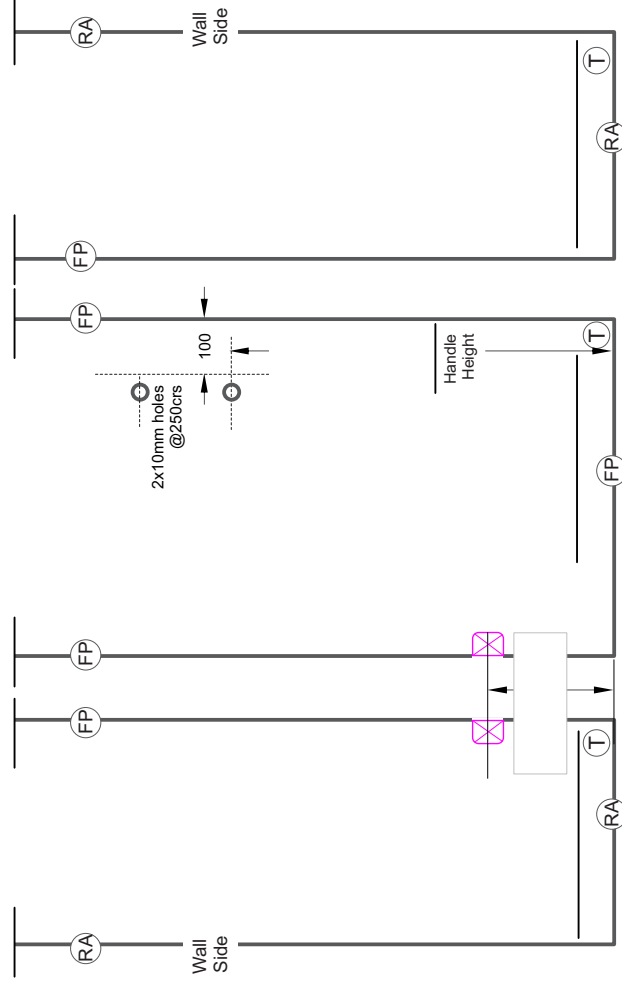

NOTES:

FRAMELESS SHOWER GLASS ORDER SHEET - HINGED

1 Glass Over Panel (if needed). Depth normally 150mm
6mm Clear Toughened Glass. All (FP) edges

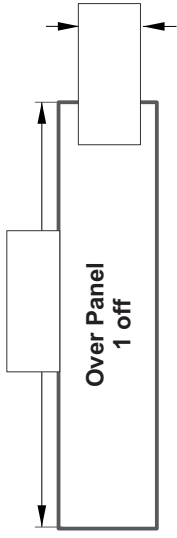

2 Hinge cutouts normally 250mm from Top/Btm edges
2 x Hinges, max Door Weight 40kg (10mm Glass = 1.6sqm)
3 x Hinges, max Door Weight 60kg (10mm Glass = 2.4sqm)
All 10mm Clear Toughened Glass

3 Hinge cutouts

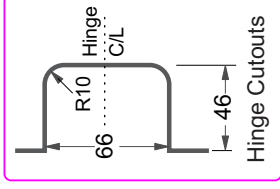

Hinge side and Dimensioning
all Viewed from Outside Shower

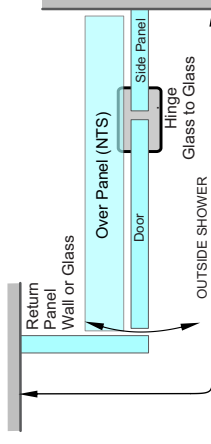

This configuration shown Below

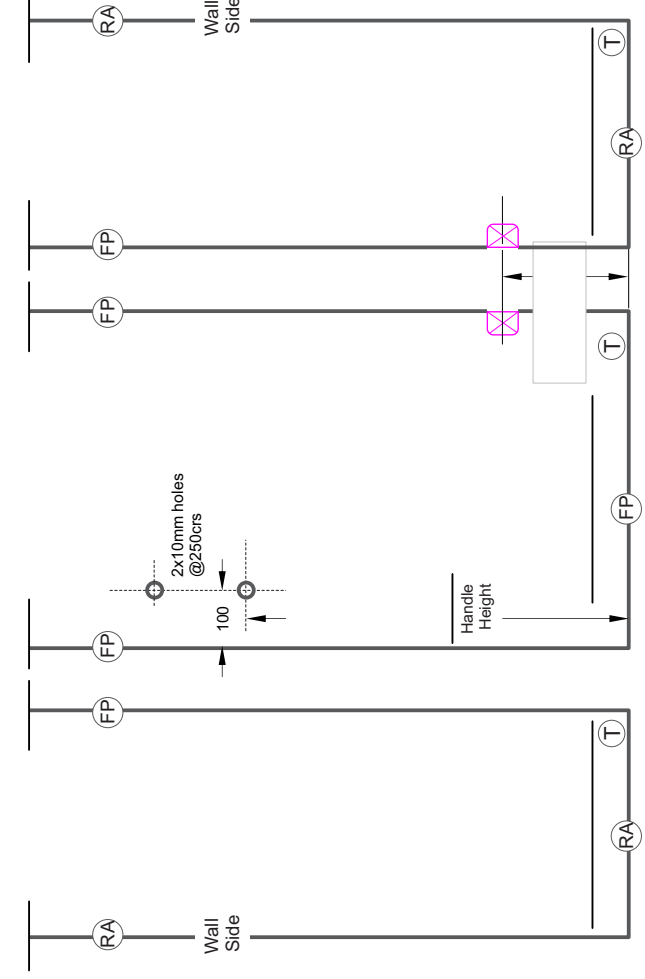
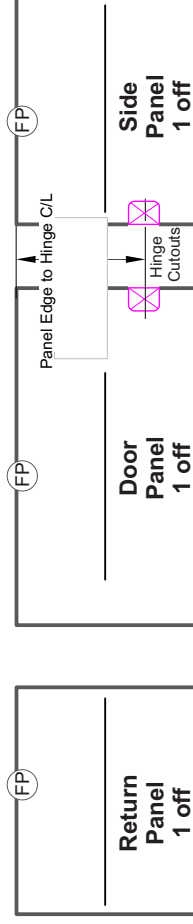

DELIVER TO:

JOBNO:

ORDER TO:

NOTES:

FRAMELESS SHOWER GLASS ORDER SHEET - HINGED

DELIVER TO:

- 1 Glass Over Panel (if needed). Depth normally 150mm
6mm Clear Toughened Glass. All (FP) edges

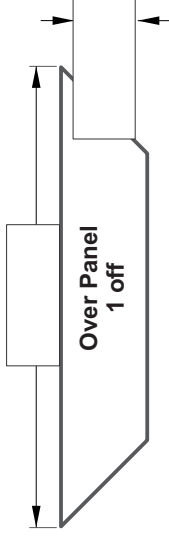

- 2 Hinge cutouts normally 250mm from Top/Btm edges
2 x Hinges, max Door Weight 40kg (10mm Glass = 1.6sqm)
3 x Hinges, max Door Weight 60kg (10mm Glass = 2.4sqm)
All 10mm Clear Toughened Glass

JOBNO:

ORDER TO:

NOTES:

- 3 Hinge cutouts

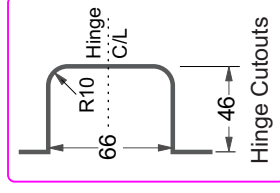

Hinge side and Dimensioning all Viewed from Outside Shower

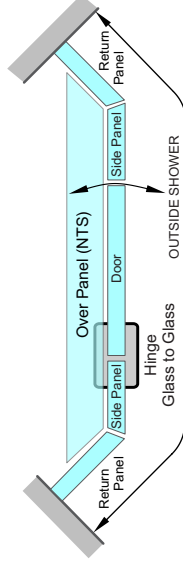

This configuration shown Below

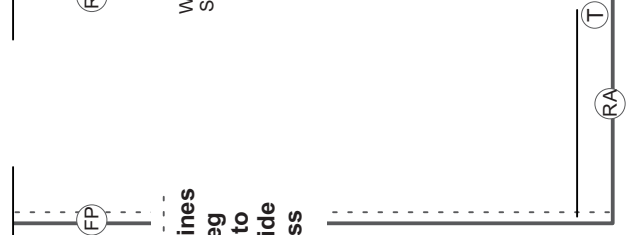
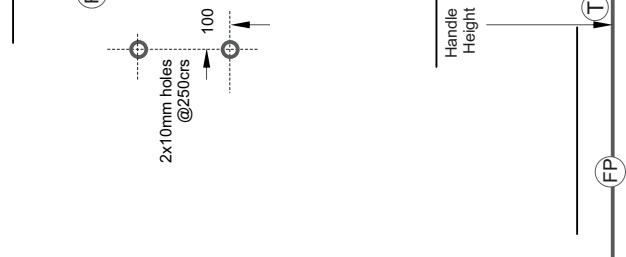
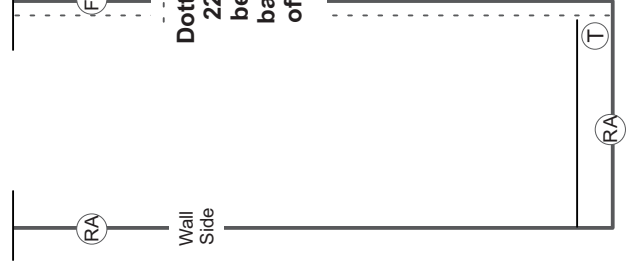
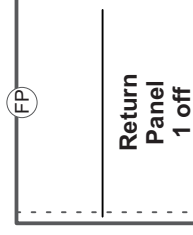
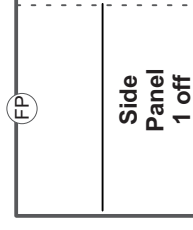
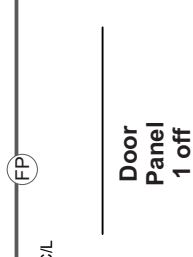
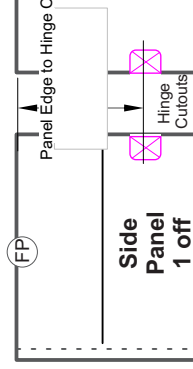
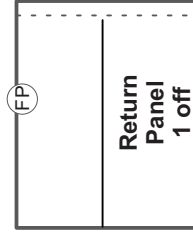

FRAMELESS SHOWER GLASS ORDER SHEET - HINGED

DELIVER TO:

.....

.....

.....

JOBNO:

.....

.....

.....

ORDER TO:

.....

.....

.....

NOTES:

- 1 Glass Over Panel (if needed). Depth normally 150mm
6mm Clear Toughened Glass. All (FP) edges

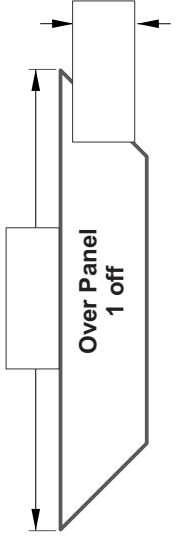

- 2 Hinge cutouts normally 250mm from Top/Btm edges
2 x Hinges, max Door Weight 40kg (10mm Glass = 1.6sqm)
3 x Hinges, max Door Weight 60kg (10mm Glass = 2.4sqm)
All 10mm Clear Toughened Glass

- 3 Hinge cutouts

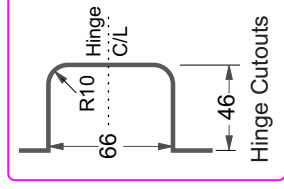

Hinge side and Dimensioning
all Viewed from Outside Shower

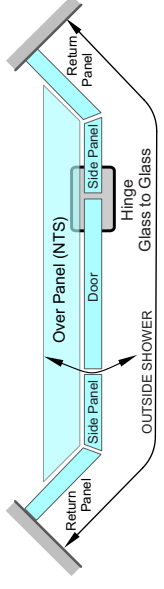

This configuration shown Below

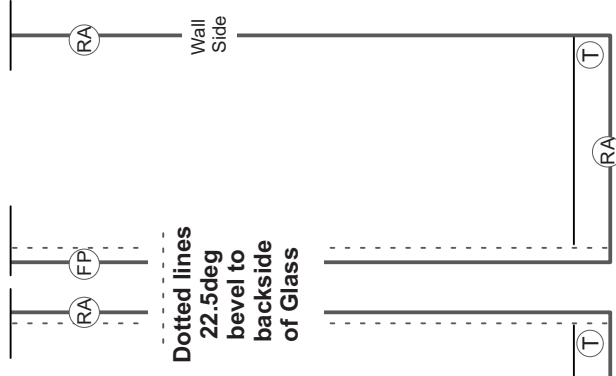
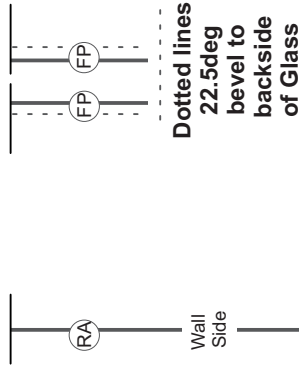
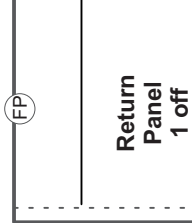
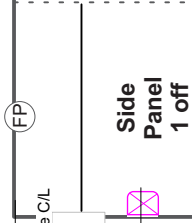
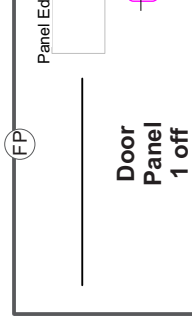
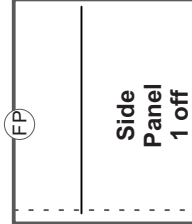
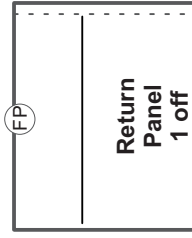

FRAMELESS SHOWER GLASS ORDER SHEET - HINGED

- 1 Glass Over Panel (if needed). Depth normally 150mm
6mm Clear Toughened Glass. All (FP) edges

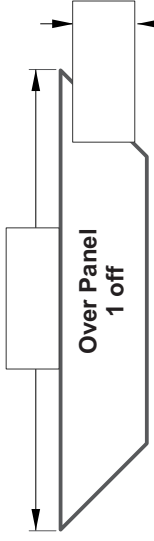

- 2 Hinge cutouts normally 250mm from Top/Btm edges
2 x Hinges, max Door Weight 40kg (10mm Glass = 1.6sqm)
3 x Hinges, max Door Weight 60kg (10mm Glass = 2.4sqm)
All 10mm Clear Toughened Glass

- 3 Hinge cutouts

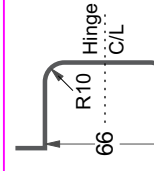

Note:
LH Cutouts x 2
below, 44 not 46mm

Hinge side and Dimensioning
all Viewed from Outside Shower

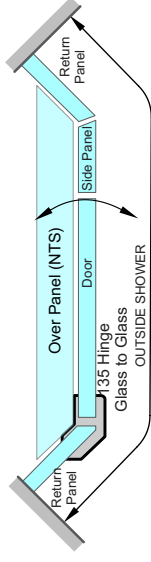

This configuration shown Below

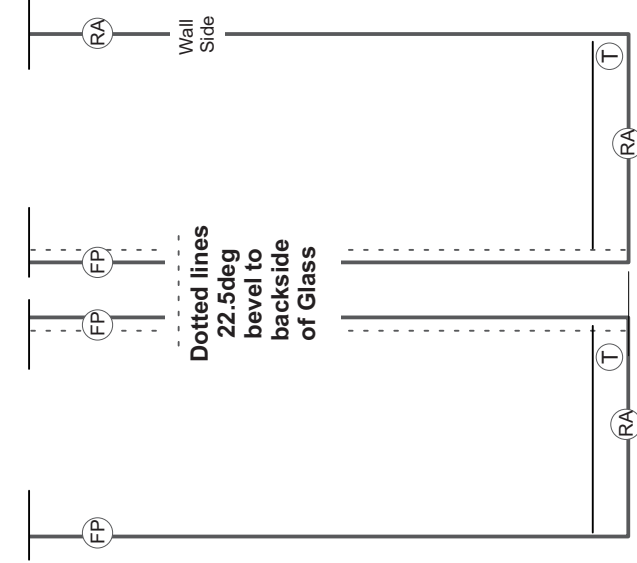
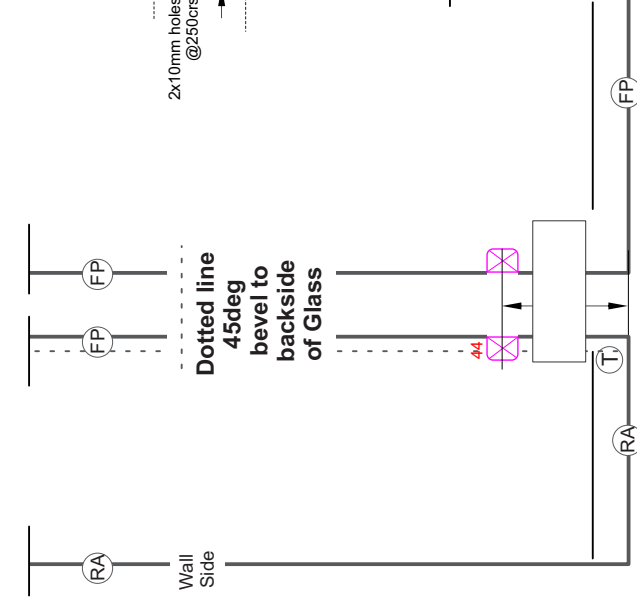
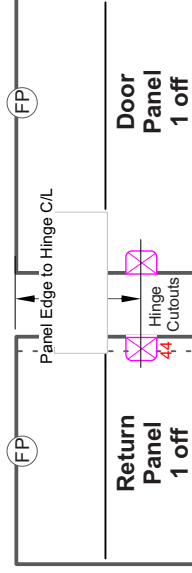

DELIVER TO:

JOBNO:

ORDER TO:

NOTES:

FRAMELESS SHOWER GLASS ORDER SHEET - HINGED

DELIVER TO:

JOBNO:

ORDER TO:

NOTES:

- 1 Glass Over Panel (if needed). Depth normally 150mm
6mm Clear Toughened Glass. All (FP) edges

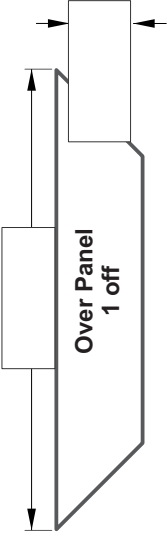

- 2 Hinge cutouts normally 250mm from Top/Btm edges
2 x Hinges, max Door Weight 40kg (10mm Glass = 1.6sqm)
3 x Hinges, max Door Weight 60kg (10mm Glass = 2.4sqm)
All 10mm Clear Toughened Glass

- 3 Hinge cutouts

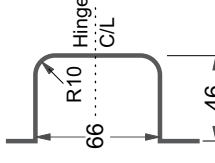

Note:
RH Cutouts x 2
below 44 not 46mm

Hinge side and Dimensioning
all Viewed from Outside Shower

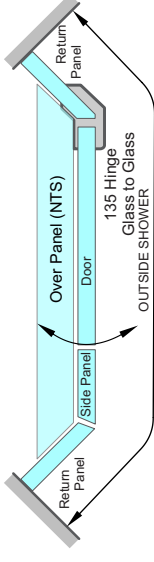

This configuration shown Below

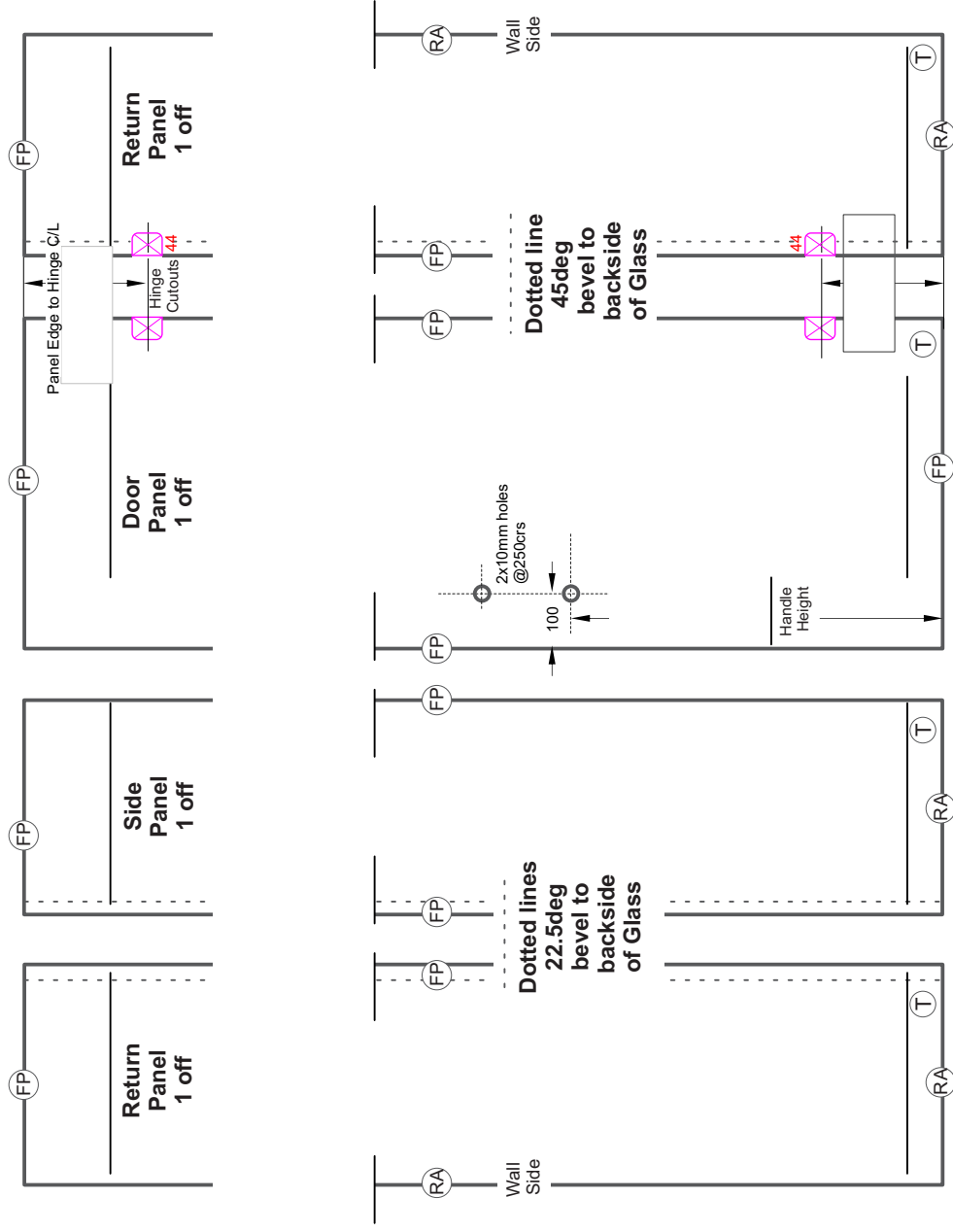

FRAMELESS SHOWER GLASS ORDER SHEET - HINGED

DELIVER TO:

.....

JOBNO:

.....

ORDER TO:

.....

NOTES:

- ① Glass Over Panel (if needed). Depth normally 150mm
 6mm Clear Toughened Glass. All (FP) edges

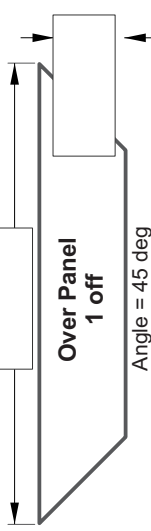

- ② Hinge cutouts normally 250mm from Top/Btm edges
 2 x Hinges, max Door Weight 40kg (10mm Glass = 1.6sqm)
 3 x Hinges, max Door Weight 60kg (10mm Glass = 2.4sqm)
 All 10mm Clear Toughened Glass

- ③ Hinge cutouts

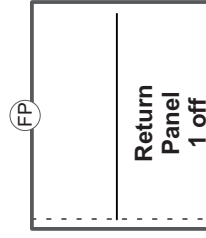
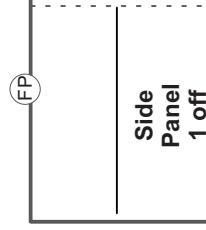
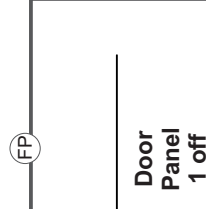
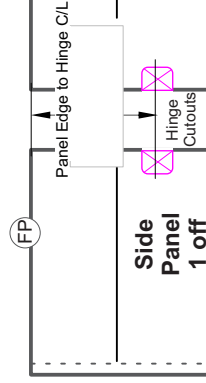
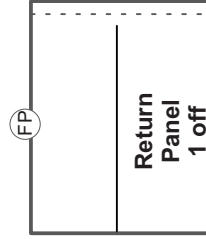
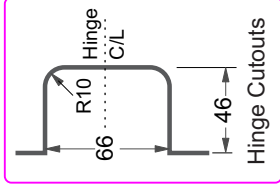

Hinge side and Dimensioning
 all Viewed from Outside Shower

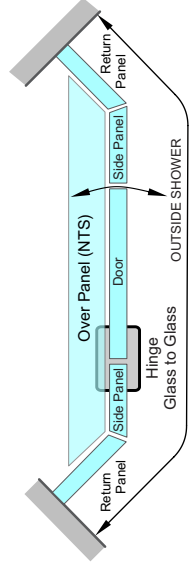

This configuration shown Below

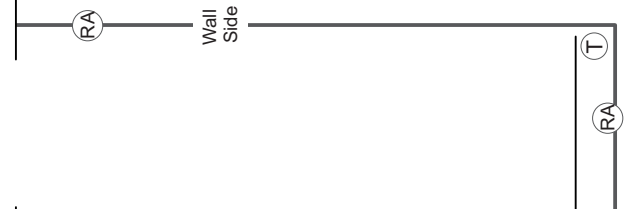
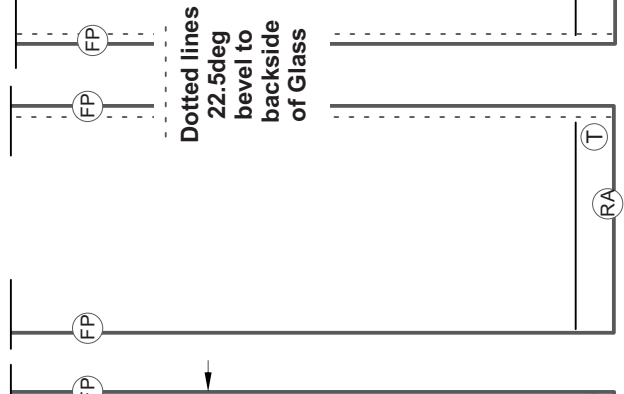
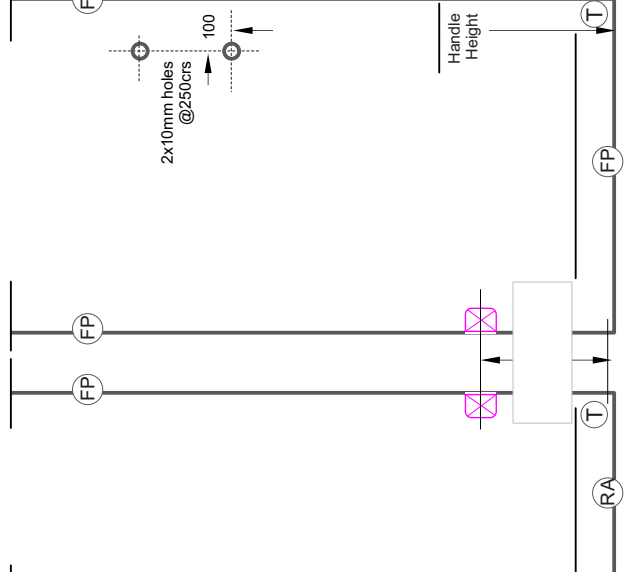
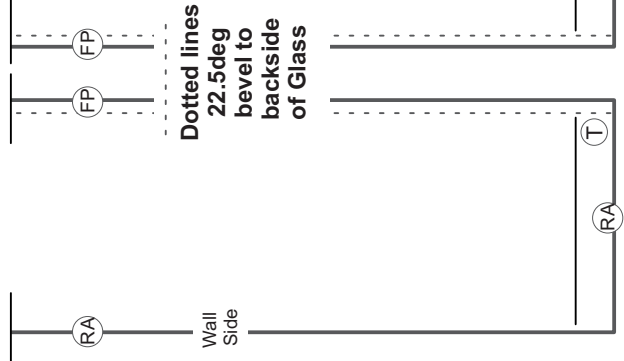

Juralco Frameless Shower Systems - Sliding Cutting Allowances

Glass Cutting Height Allowances

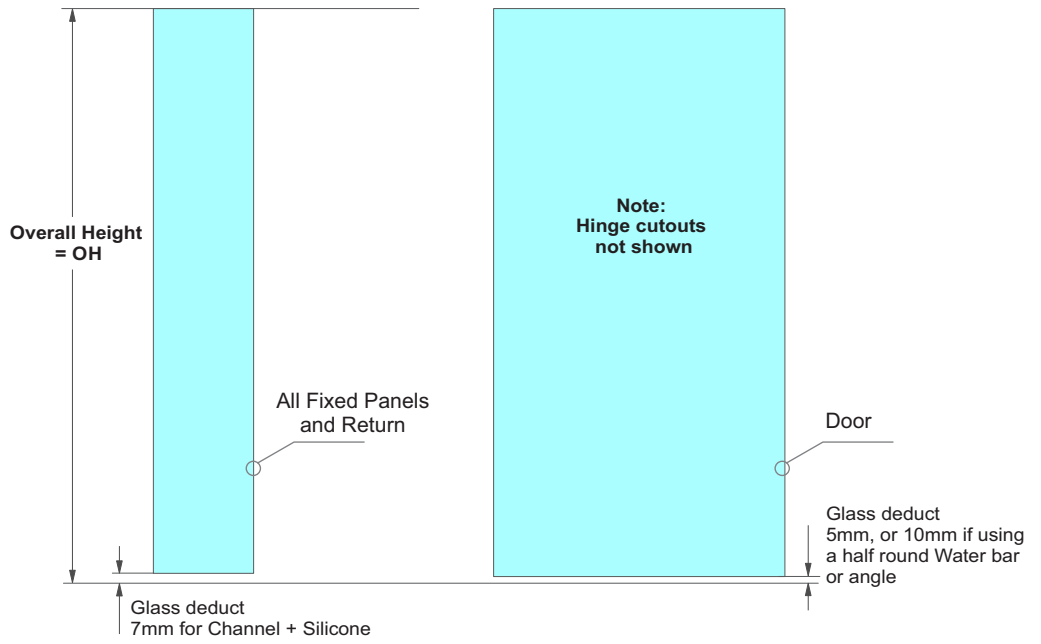

Sliding Door Shower Layouts

NOTE; These Drawings are schematic only and are not to scale

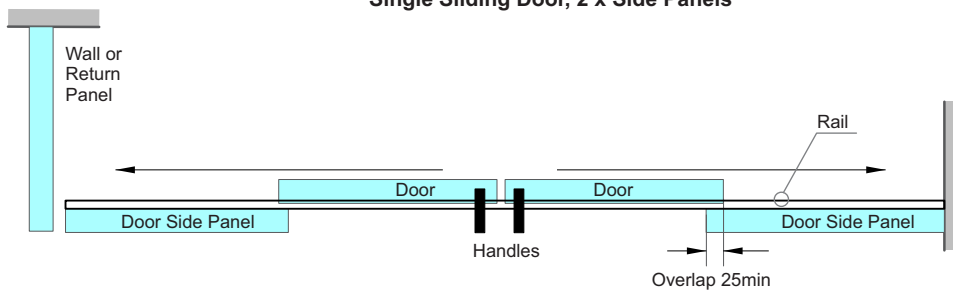
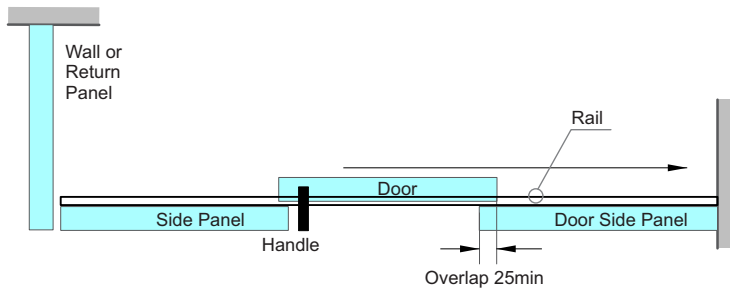
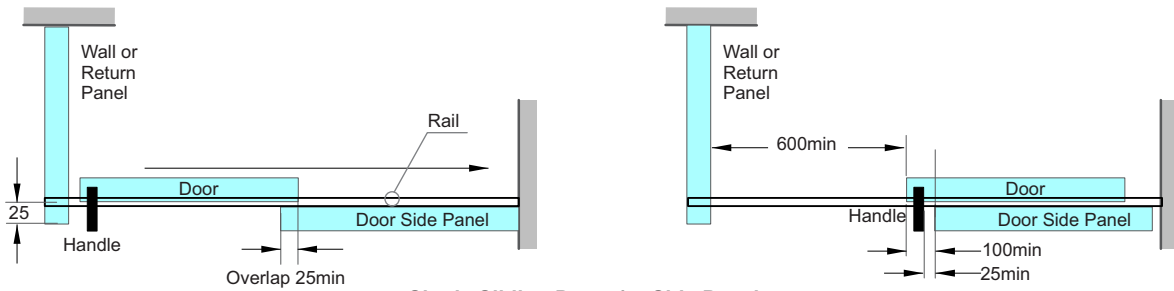

Juralco Frameless Shower Systems - Sliding Components

Codes	Finishes
BB	Brushed Brass
BG	Brushed Gold
BN	Brushed Nickel

Codes	Finishes
BRG	Brushed Rose Gold Copper
CP	Polished Chrome
GM	Brushed Gun Metal
MB	Matt Black

Codes	Finishes
NAT	Natural Anodised
PSS	Polished SS
SB	Satin Brass
SCC	Powder Coated

Codes	Finishes
SCP	Satin Chrome
SN	Brushed Satin Nickel
SSS	Satin SS
STE	Sterling Bright Anodised

Oasis Sliding Shower Kits

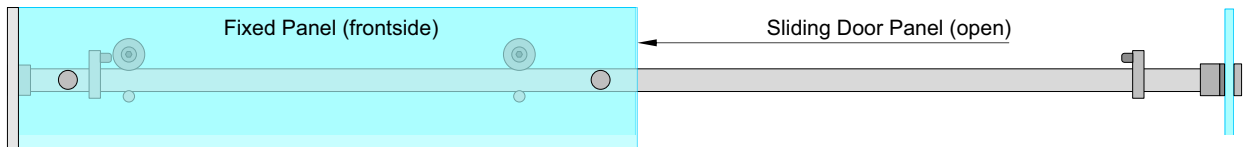
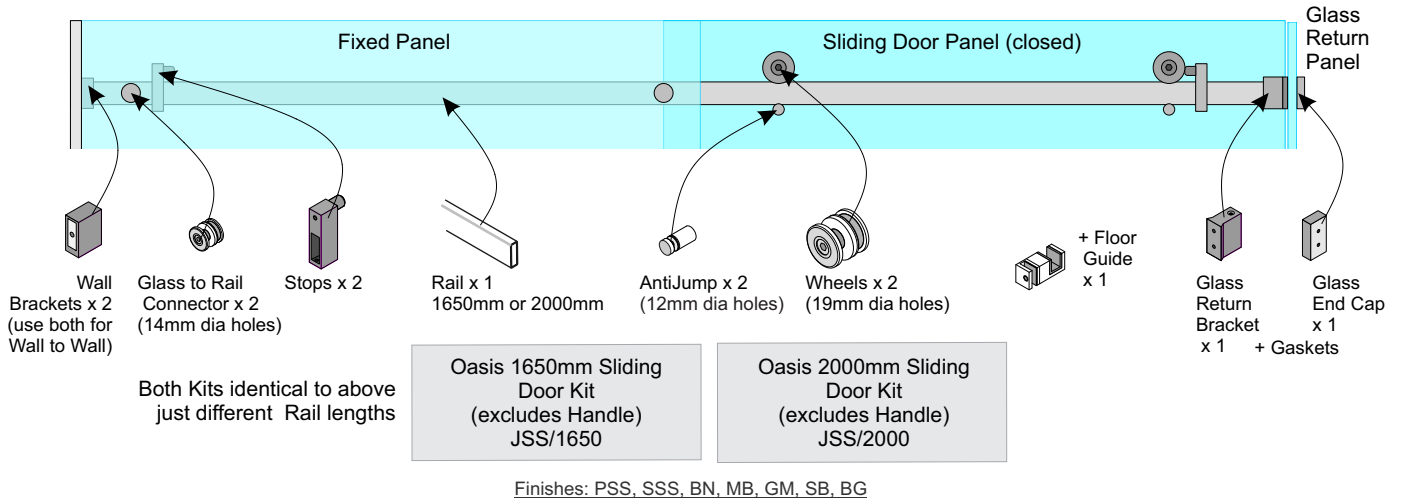

Note - Fixed Glass Panel. Cut bottom Channel 20mm short to allow for Floor Guide

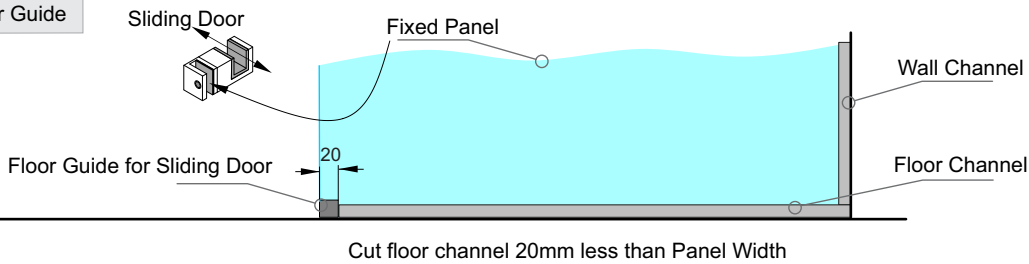

Glass Cutting Width Allowances

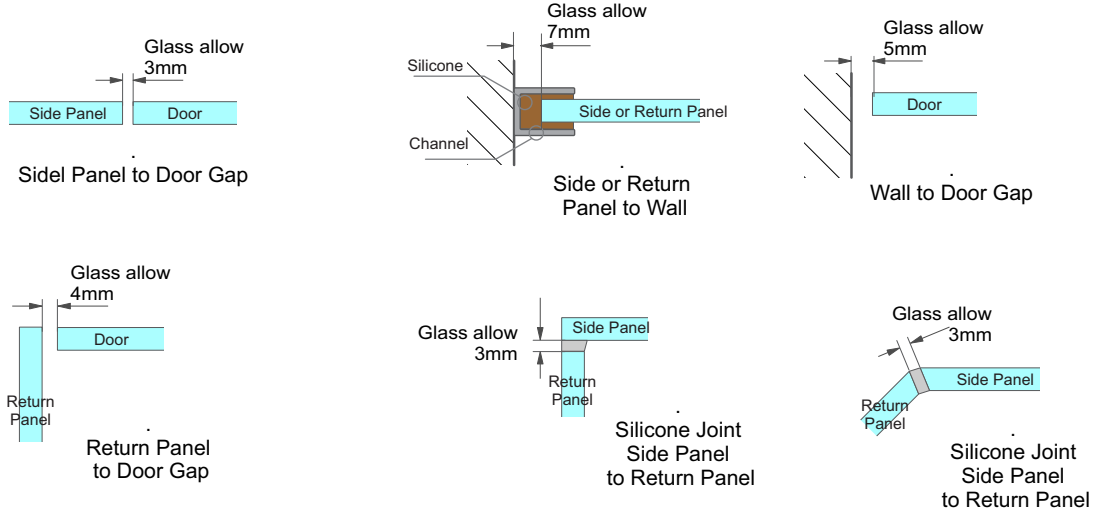

Measuring, Cutting, Installing Floor and Wall Channels

- Check shower opening for squareness. Adjust glass channels by packing them up/out if opening is less than 3-5mm out of square.
- Adjust Side Panels for proper glass cover if walls are out of square by 3-5mm.
- Measure and Cut your channels, when measuring for your Wall channels, make sure to deduct 18mm from the total height.
Also make sure to know how much you are going to pack up the glass off the bottom channel as you will need to add this back on to ensure that the side guides internal measurements will be the same height as the Side Panels final height
e.g (Final height of shower required is 2000mm, Measurement for Side channel for this glass will be 2000mm – 18mm + 5mm (Channel height +3mm packing in the bottom channel) Cut size= 1987)
- The Floor channel will be the full width of the glass +5mm e.g. (The Side Panel width is 700mm, so the bottom channel will be 700mm + 5mm (for silicone and packing) Cut size =705mm.
- **Cutting the Floor channel for the Door Side Panel only. Deduct 20mm from this total measurement to allow for the bottom door guide, as this needs the glass sticking out of the channel 20mm for this to attach to.**
- These examples show the cutting sizes for your glass channels if they are butted together. You can mitre these joins if you would like to. These measurements will be the total size height and width +5mm in each direction for packing material and silicone but with a 45 Deg mitre in the joining corner.
- Once your channels are cut for all your Side and Fixed panels, install these using “Bostik V60” Structural silicone ensuring full coverage of the underside of the channel to Walls and Floor Tiles
Place these down in the marked locations predetermined and make sure to plumb these up using either a level or a laser.
- After gluing the channels down and applying pressure, some silicone may have come out the sides; tidy this up using soapy water in a spray bottle and a silicone spatula. (Tip, clean your spatula after every wipe to ensure no smudging of the silicone onto the channel finish. Always make sure the silicone has soapy water on it before each wipe to avoid this also)
- Allow the Silicone/Channels joint to mature in place at least 48 hrs before installing the glass (Silicone reaches full cured strength in 7 days).
- Once the channels are clean and dry, you are ready to install your glass.

Installing Glass

- Make sure to install your predetermined packer (3mm in this example) then place a bead of silicone in the back of the channel making sure to have extra silicone in the joins in the channel as this is where it is prone to leaking if not fully sealed
- Install glass ensuring that the panel is plumb in all directions.
- Silicone the outside of the channel to fill any of the gaps that may have formed
- Using Wedge PN 31 cut to length, using a wedge roller roll this into the inside edge of the glazing channel.
This will force the glass panel to the outside of the channel. Clean excess and allow to dry for 48hrs or more.
- Or Silicone both side of Glass and press glass to outside edge. Then remove excess silicone. Allow 48 hrs to set or 7 x days for full cure.

Installing Hardware

- Prepare hardware, measure and cut the Stainless steel Rail to the desired length for your shower.
As this is Stainless steel it requires cutting with an angle grinder, Steel drop saw or a hacksaw cutting at a slow pace. Take off any burrs.
(This should run from the Side Panel to the wall)
- Mark out your Rail for drilling. Drill 6.5mm dia holes in the Bar for attaching this to your door side panel using the supplied hardware
- Once the two holes are marked out, use a center punch to create an indent to guide your drill bit.
- It is recommended to drill a smaller hole and work your way up to the desired hole size using your choice of lubricating compound.
- Slide both End Stops on the drilled bar, facing ea other
- **Wall to Glass Return** - Install the Wall Bracket. Slide the Glass Return Bracket onto one end of the Rail. Mark and centre punch the Bar.
Drill 2 x 3.5mm dia holes top and bottom. Install the Glass Return Bracket to your Return Panel using the Glass Endcap.
There are two M4x20 screws and a gasket to protect the glass. Tighten these accordingly. Insert the Bar + Stops before final installation
- **Wall to Wall Return** - Install both Wall Brackets. Insert the Bar + Stops before final installation.

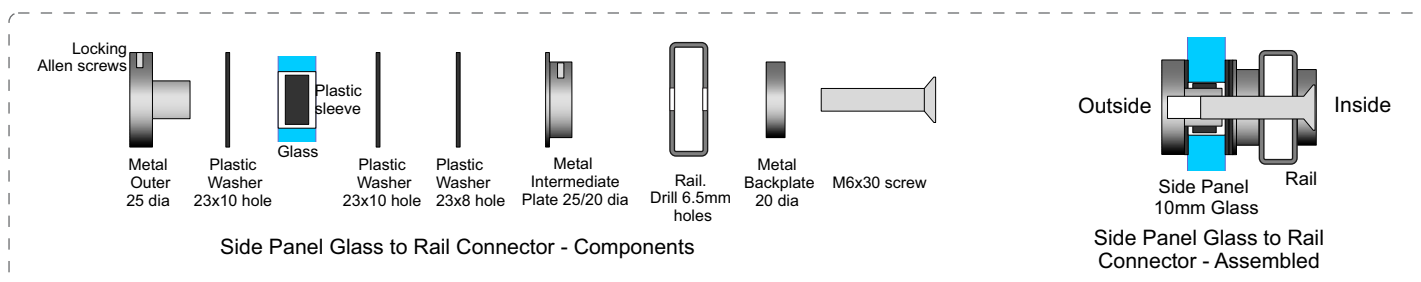

- Install the **Glass-to-Rail** connectors onto the rail. There must be 1 x washer on the Outside and 2 x washers on the Inside of the Glass. Tighten up.
- Insert the rail into the Glass Return bracket (and Wall Bracket(s) if applicable) and screw the Glass-to-Rail connector onto the rail
(Lock these using a small Allen key in the side of the Metal Outer/Intermediate plates)
- Ensure that the rail is level to ensure that the door does not roll open or close by itself.
- Tighten the Allen key underneath the Glass Return Bracket and Wall brackets to lock it in place.
- Install Door Wheels to the door and hang the door on the rail.
- Once the door is hung on the Wheels, you can install the Anti-jump components to the door.
- Slide the door to the open position and then install the Floor Guide to the Door Side Panel, sliding this on and tightening then onto the glass.
- There is height adjustment in the Door wheels and these can adjust the door height using the Allenkey in the face of the door wheels on the inside.
- Install the handle to the door.
- Make sure everything is tight and operating as intended. - Install all covers to the Allen key heads
- Clean glass and stainless using glass cleaner.

FRAMELESS SHOWER GLASS ORDER SHEET - OASIS SLIDING SYSTEMS

DELIVER TO:

.....

.....

.....

JOBNO:

.....

.....

.....

ORDER TO:

.....

.....

.....

NOTES:

.....

.....

.....

1 Glass Panels.

Max door weight 45kg (for 10mm Glass = 1.8sqm)
 Door Side Panel (Rail Mounts) Max width 750mm
 All 10mm Clear Toughened Glass

2 Rail cutout

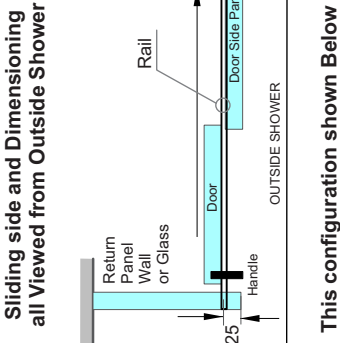
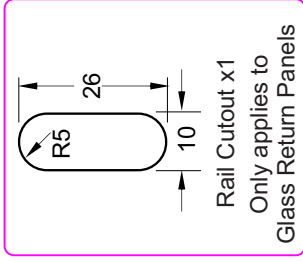

This configuration shown Below

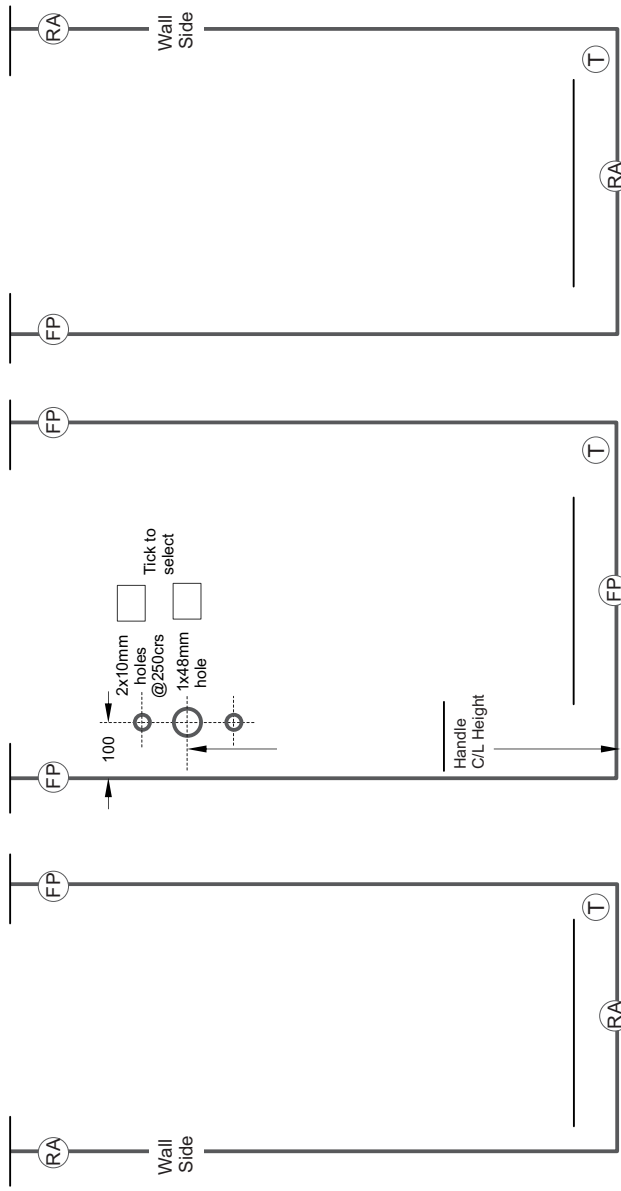
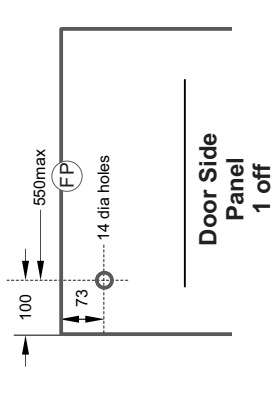
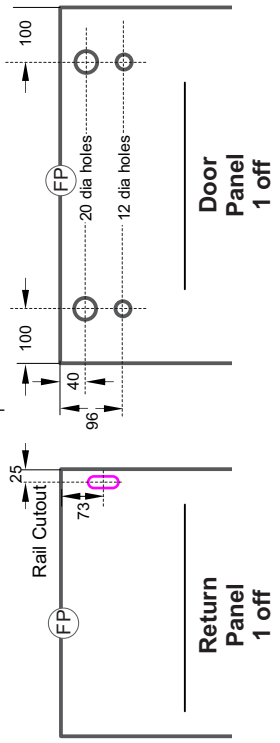

FRAMELESS SHOWER GLASS ORDER SHEET - OASIS SLIDING SYSTEMS

1

Glass Panels.

Max door weight 45kg (for 10mm Glass = 1.8sqm)
 Door Side Panel (Rail Mounts) Max width 750mm
 All 10mm Clear Toughened Glass

DELIVER TO:

.....

JOBNO:

.....

ORDER TO:

.....

NOTES:

.....

2

Rail cutout

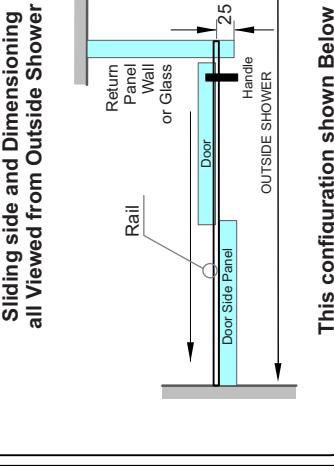
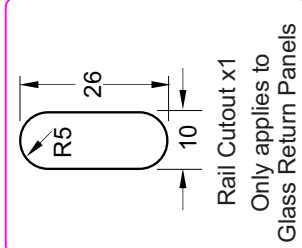

This configuration shown Below

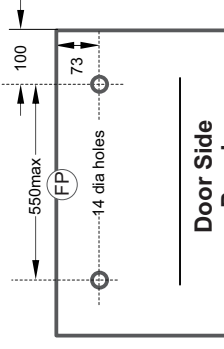

Door Side Panel
1 off

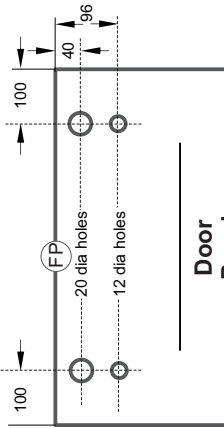

Door Panel
1 off

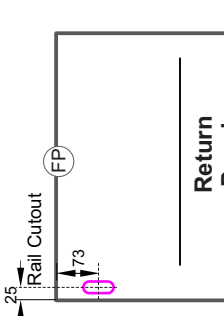

Return Panel
1 off

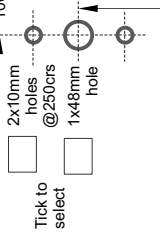
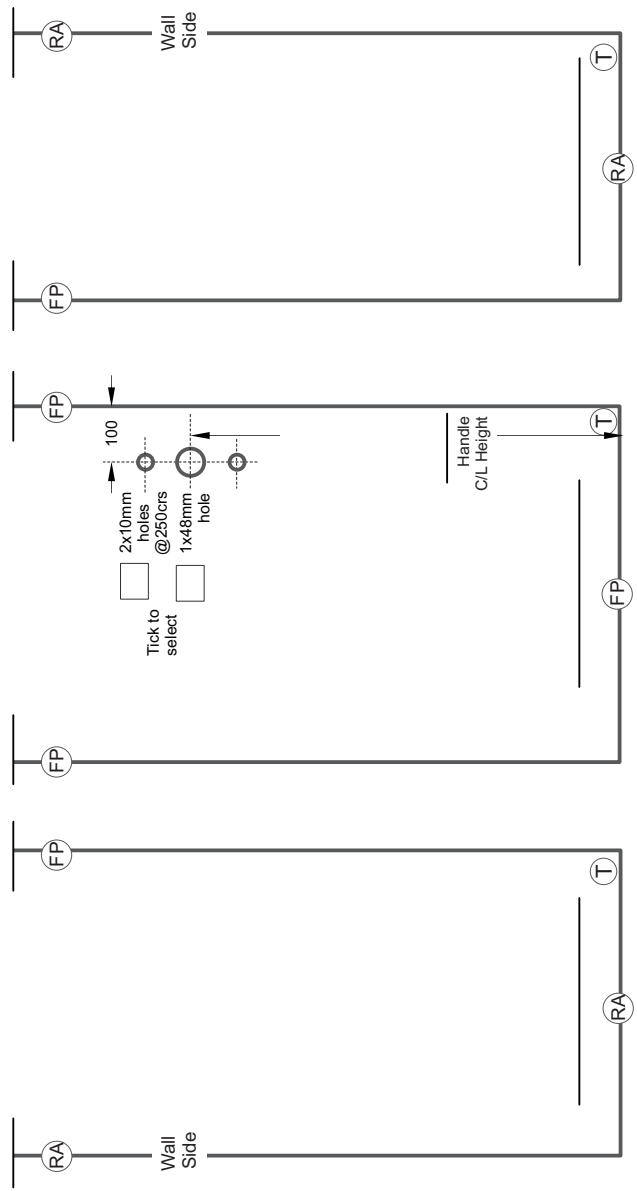

FRAMELESS SHOWER GLASS ORDER SHEET - OASIS SLIDING SYSTEMS

1

Glass Panels.

Max door weight 45kg (for 10mm Glass = 1.8sqm)
 Door Side Panel (Rail Mounts) Max width 750mm
 All 10mm Clear Toughened Glass

2

Rail cutout

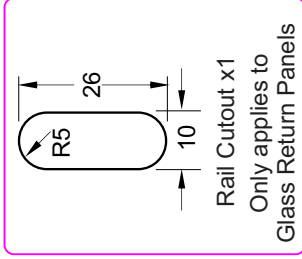

Sliding side and Dimensioning all Viewed from Outside Shower

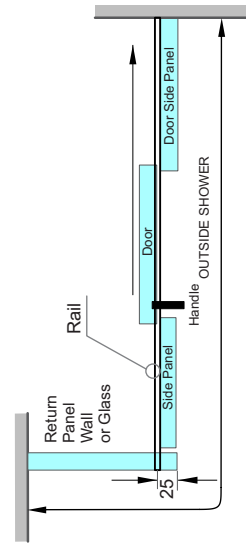

This configuration shown Below

DELIVER TO:

.....

JOBNO:

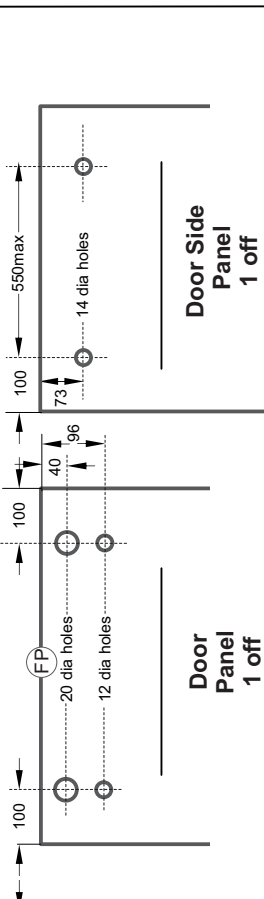
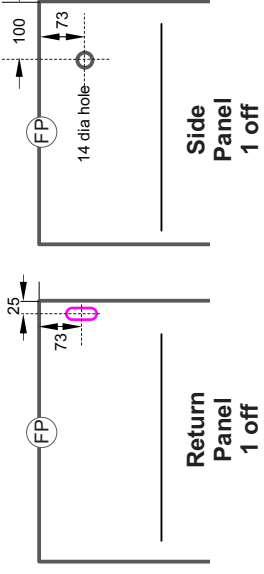

ORDER TO:

.....

NOTES:

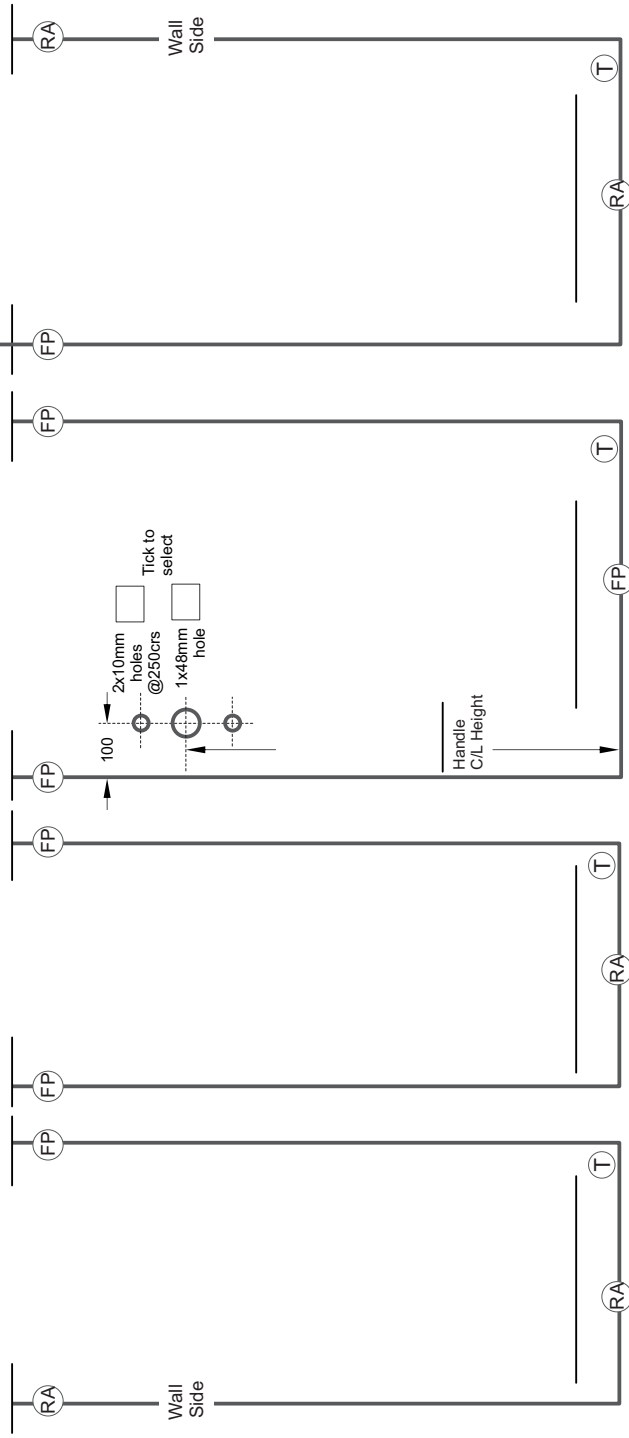

FRAMELESS SHOWER GLASS ORDER SHEET - OASIS SLIDING SYSTEMS

1

Glass Panels.

Max door weight 45kg (for 10mm Glass = 1.8sqm)
 Door Side Panel (Rail Mounts) Max width 750mm
 All 10mm Clear Toughened Glass

DELIVER TO:

.....

JOBNO:

.....

ORDER TO:

.....

NOTES:

.....

2

Rail

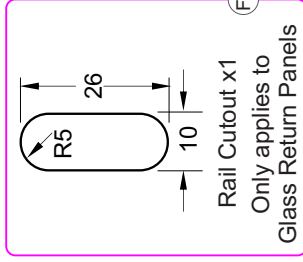

Rail Cutout x1
 Only applies to
 Glass Return Panels

Sliding side and Dimensioning
 all Viewed from Outside Shower

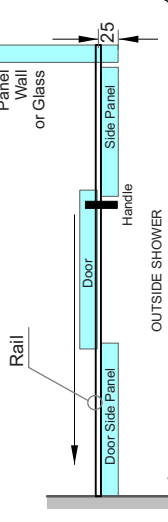

This configuration shown Below

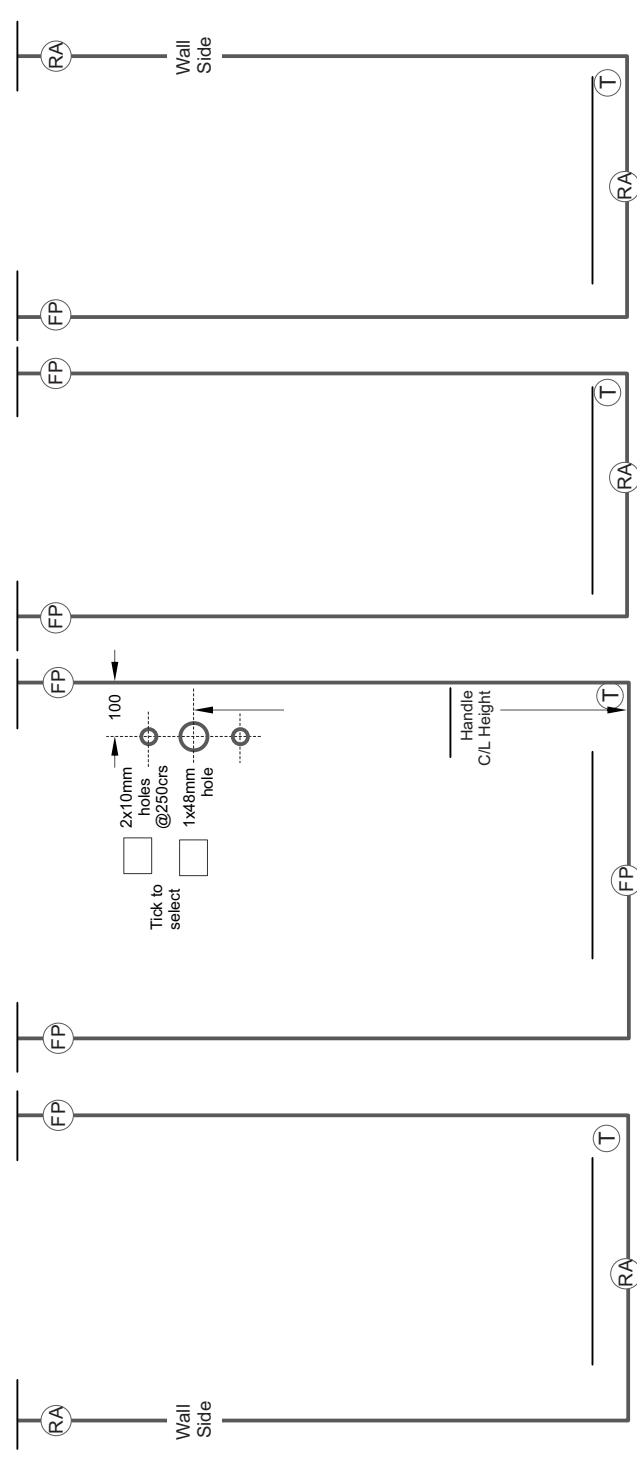
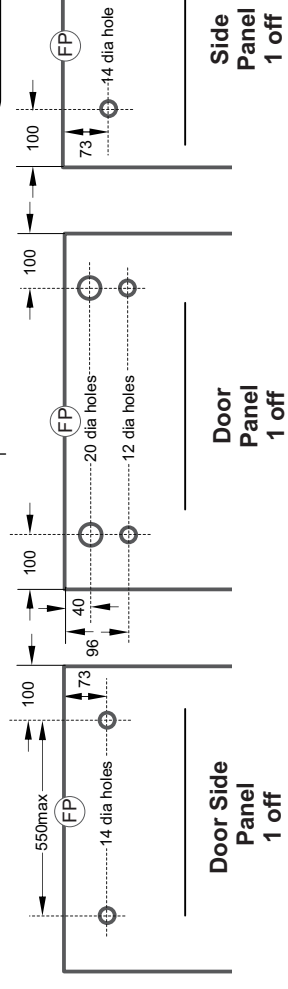

FRAMELESS SHOWER GLASS ORDER SHEET - OASIS SLIDING SYSTEMS

DELIVER TO:

.....

.....

.....

JOBNO:

.....

.....

.....

ORDER TO:

.....

.....

.....

NOTES:

.....

.....

.....

1

Glass Panels.

Max door weight 45kg (for 10mm Glass = 1.8sqm)
 Door Side Panel (Rail Mounts) Max width 750mm
 All 10mm Clear Toughened Glass

2

Rail cutout

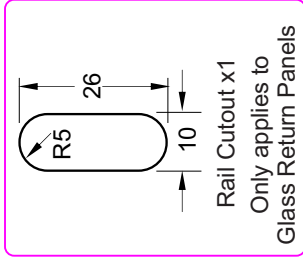

Sliding side and Dimensioning
 all Viewed from Outside Shower

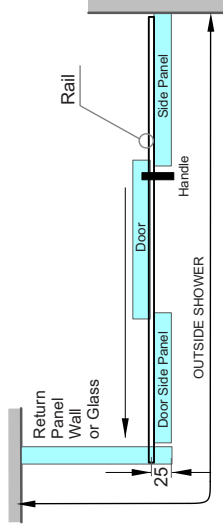

This configuration shown Below

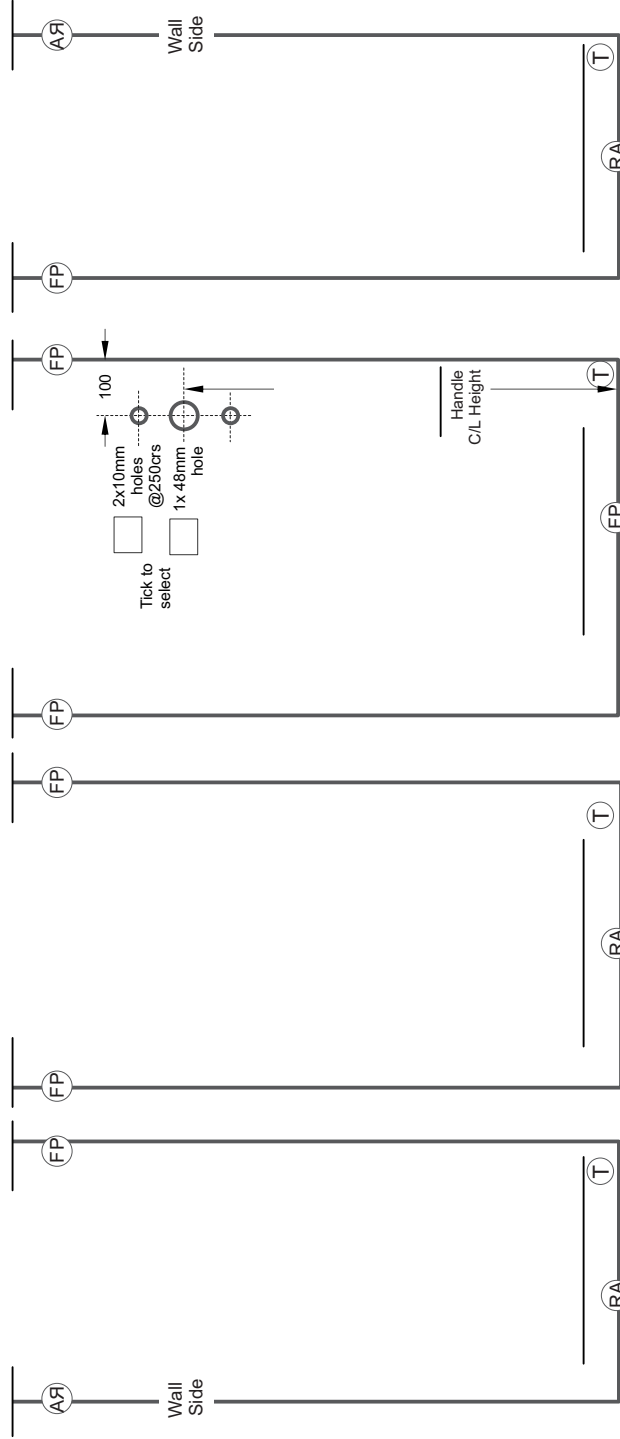
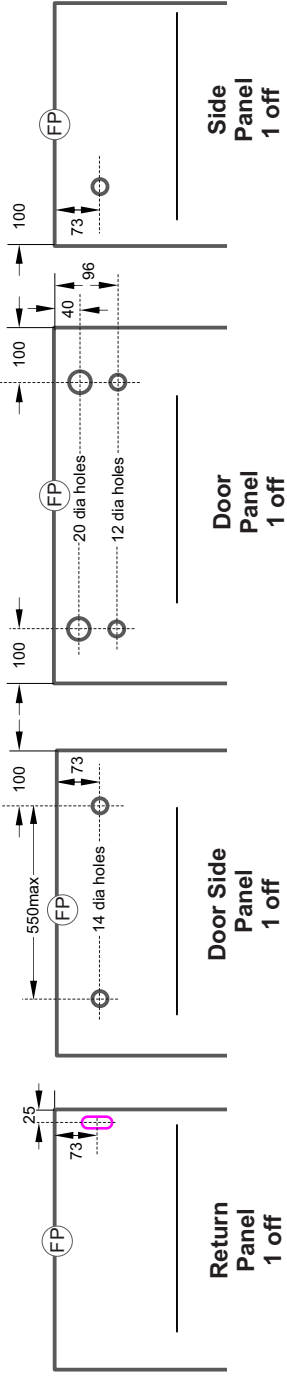

FRAMELESS SHOWER GLASS ORDER SHEET - OASIS SLIDING SYSTEMS

1

Glass Panels.

Max door weight 45kg (for 10mm Glass = 1.8sqm)
 Door Side Panel (Rail Mounts) Max width 750mm
 All 10mm Clear Toughened Glass

2

Rail

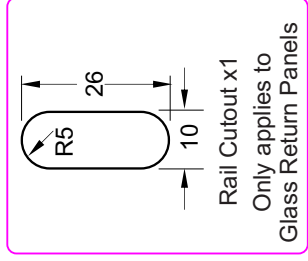

Sliding side and Dimensioning all Viewed from Outside Shower

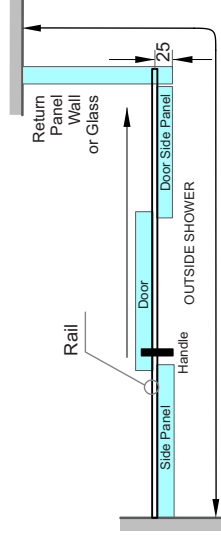

This configuration shown Below

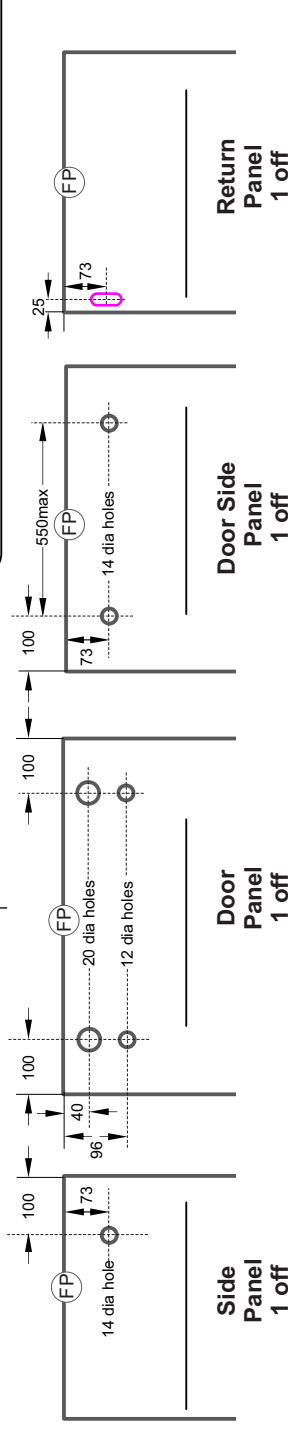

JOBNO:

ORDER TO:

NOTES:

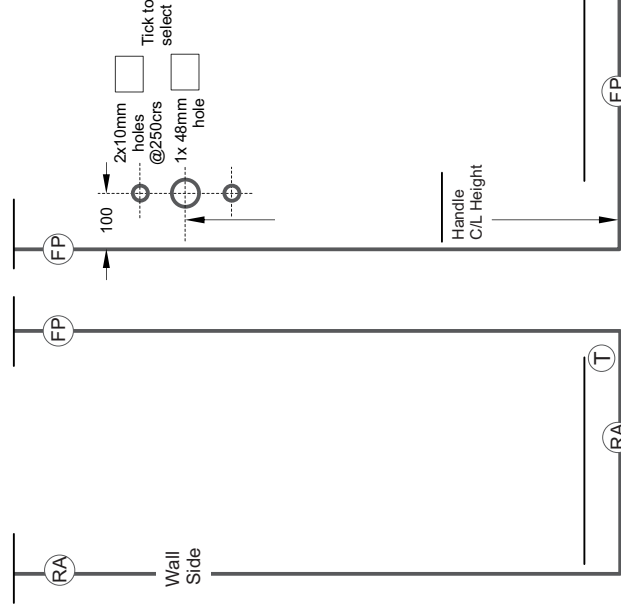

FRAMELESS SHOWER GLASS ORDER SHEET - OASIS SLIDING SYSTEMS

1

Glass Panels.

Max door weight 45kg (for 10mm Glass = 1.8sqm)

Door Side Panel (Rail Mounts) Max width 750mm

All 10mm Clear Toughened Glass

Return Panel not shown below, NO Holes. If Glass

	Height
	Width

Sliding side and Dimensioning all Viewed from Outside Shower

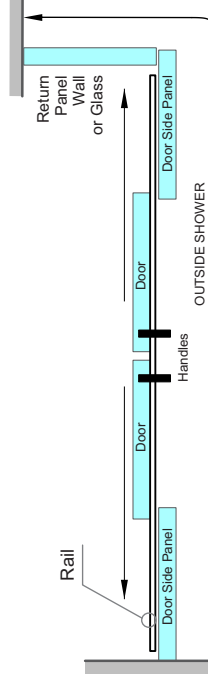

This configuration shown Below

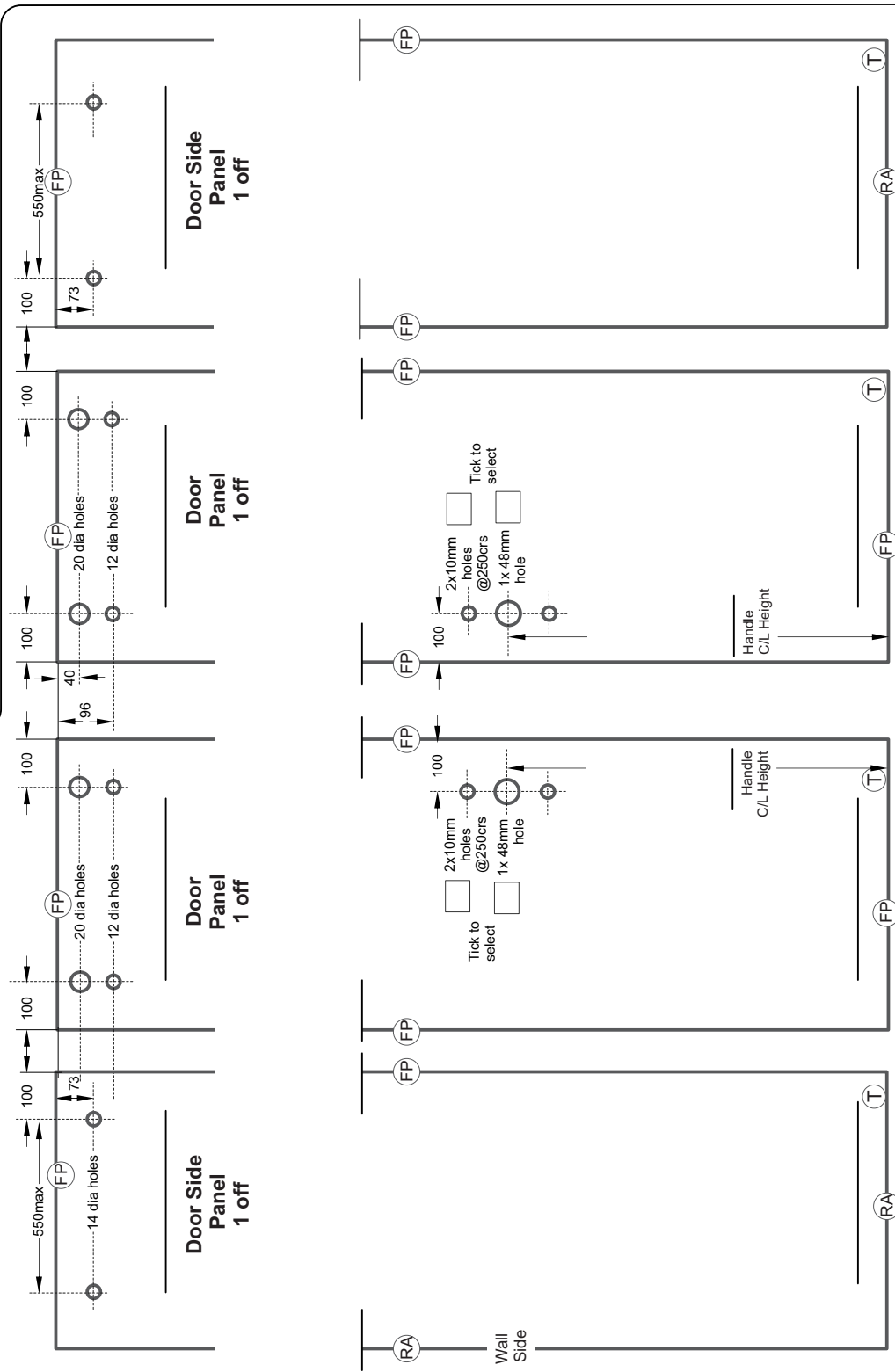

DELIVER TO:

JOBNO:

ORDER TO:

NOTES:

FRAMELESS SHOWER GLASS ORDER SHEET -

Fixed Panels and Door all 10mm Clear Toughened Glass

DELIVER TO:

JOBNO:

ORDER TO:

NOTES:

FRAMELESS SHOWER GLASS ORDER SHEET -

Fixed Panels and Door all 10mm Clear Toughened Glass

DELIVER TO:

JOBNO:

ORDER TO:

NOTES: