

AMPLIMESH®

Insect Screens



AMPLIMESH®
SCREEN PRODUCTS





Venette Pleated Two Panel Retractable
Screen Door (2C)

Your ultimate insect screen is a stylish architectural solution, literally opening up the screening possibilities for your home. Robust and modern, Venette pleated screens can be custom made for single, double, bifold and sliding doors, including multiple stacking doors with widths up to 9.3 metres.

Elegant and easy to use, Venette glides smoothly with the touch of a finger, can be stopped in any position and magnetically latches shut. The discrete 3mm track installs flat to the ground, so there is no bottom channel, or guide wires to trip on or step over.

Strong aluminium frames, high quality polyester pleated mesh and Kevlar guide wires combine with exclusive patented features to prevent the mesh from sagging.



Can be stopped in any position

Variety of configurations



No bottom channels

Easy to use

CUSTOM MADE IN NZ

SPECIFICATIONS

- MAXIMUM HEIGHT** 3000mm **MIN HEIGHT** 1020mm
 - MAXIMUM SINGLE PANEL WIDTH* (1E)**
 (Without visible mesh in closed position) - 1350mm
 (With visible mesh in closed position) - 1550mm
 (With Centre Support Rods & visible mesh in closed position): 2000mm
 - MAXIMUM DOUBLE PANEL WIDTH* (2C)**
 (Without visible mesh in closed position) - 2700mm
 (With visible mesh in closed position) - 3100mm
 (With Centre Support Rods & visible mesh in closed position): 4000mm
 - MAXIMUM MULTIPLE PANEL WIDTH***
 (Without visible mesh in closed position) - 8100mm
 (With visible mesh in closed position) - 9300mm
- *Note: Notwithstanding the above the maximum width per Panel = overall height less 300mm

FIXING Reveal fix or face fix with buildout

CUSTOM COLOUR SELECTION

Dulux Duralloy powder coated in NZ, matched to existing joinery

Opening Configurations

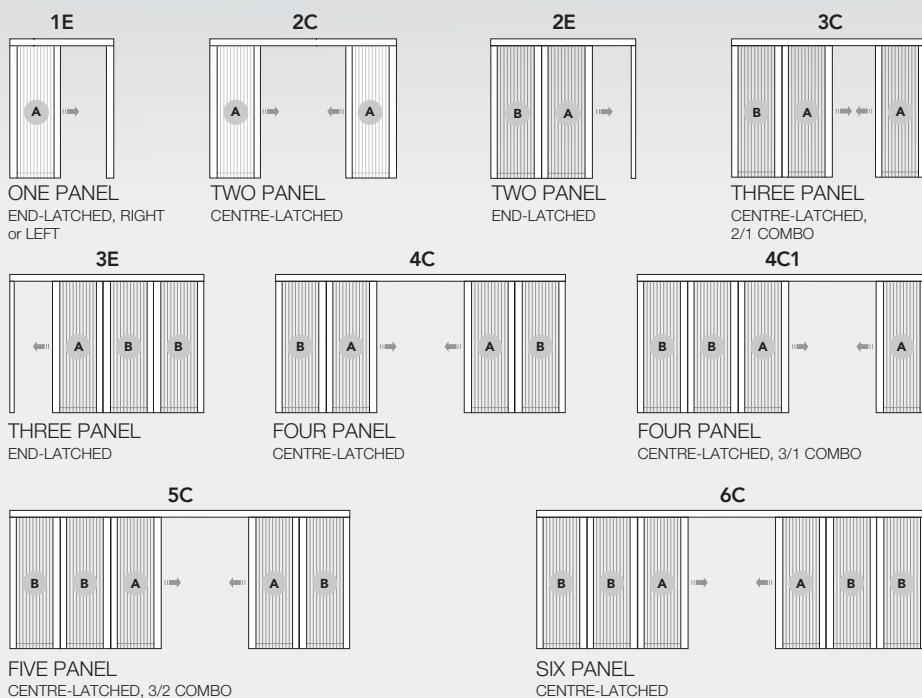

LEGEND **A** END PANEL WITH MAGNETIC SEAL

B PANEL WITH CONNECTOR

Pleated Screen Part Profiles

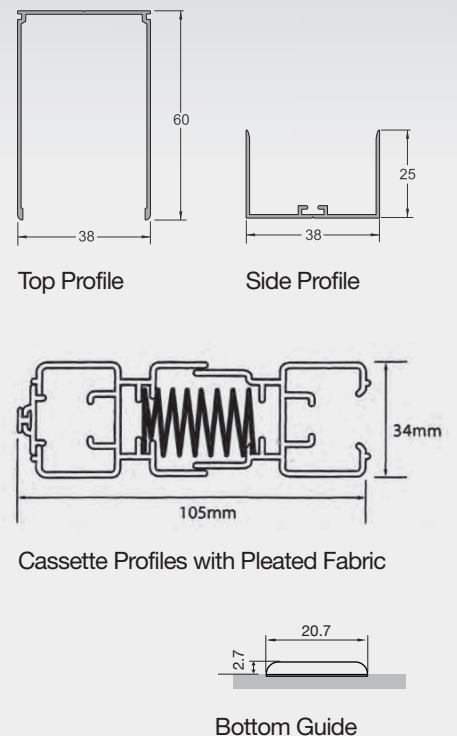



Cicero One Panel Retractable
Screen Door (1E)

New generation Cicero retractable insect screen doors open up a world of screening options which are stylish, robust and easy to use. Combining the benefits of advanced retractable screen technology and modern pleated mesh doors, Magari screens are a revolution in retractable screen doors.

User friendly features include integrated handles, full length magnetic latching and a slow rewinding function when doors are being opened or stored away. Smooth and effortless to open, Cicero uses the same “caterpillar” like track system as the Venette Pleated Screens, discreetly retracting into the matching frame when not in use. The 5mm bottom guide is inconspicuous and low enough that there is nothing to trip on or step over.

Cicero Screens use a slim, flat black mesh, with a highly transparent finish, in line with the most modern of insect screens on the market. Once fitted into the high quality aluminium frames, the mesh is extremely stable and has the added benefit of UV resistance for the harsh NZ environment.



Cicero Two Panel Retractable Screen Door (2C)

No bottom channel

CUSTOM MADE IN NZ

SPECIFICATIONS

- MAX HEIGHT** 2200mm **MIN HEIGHT** 1020mm
- MAX SINGLE PANEL WIDTH* (1E)** 1800mm
- MAX DOUBLE PANEL WIDTH* (2C)** 3600mm

*Note: Notwithstanding the above the maximum width per panel = overall height less 300mm

FIXING

Reveal fix or face fix with buildout

CUSTOM COLOUR SELECTION

Dulux Duralloy powder coated in NZ, matched to existing joinery

Opening Configurations

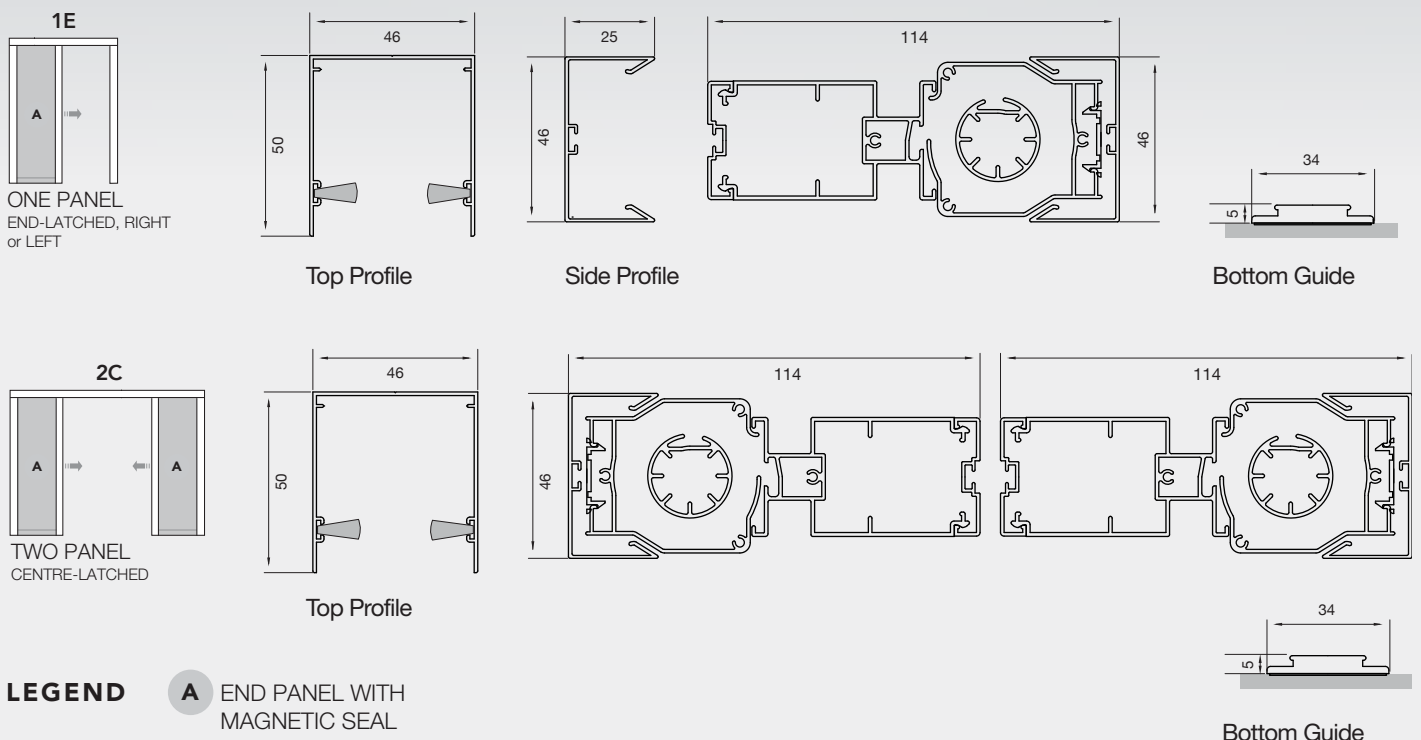

A clever way to keep insects and mosquitoes at bay! Genius Italian designed retractable screen doors feature a low profile 23mm aluminium bottom channel and roll up into an attractive aluminum cassette when not in use.

Other features include:

- Brake for Safe and Controlled Retraction
- Full Length Magnetic Closing Seals
- Blowout Resistant Brush Pile
- Two Cassette Choices: 36mm or 46mm
- Double or Single Door Configurations
- Optional Full Length Sturdy Pull Handle
- Matching Vertical Versions for Windows

CUSTOM MADE IN NZ

SPECIFICATIONS

SINGLE DOORS

MIN WIDTH	500mm
MAX WIDTH	S36 - 1500mm S46 - 1700mm
MIN HEIGHT	1000mm
MAX HEIGHT	2400mm

DOUBLE DOORS

MIN WIDTH	1000mm
MAX WIDTH	S36 - 3000mm S46 - 3400mm
MIN HEIGHT	1000mm
MAX HEIGHT	2400mm

INSECT MESH	Fibreglass 18x16 Charcoal / Pet Resistant Mesh
HARDWARE	Stainless Steel Spring, Viscodynamic Brake, Anti-Wind Pile
COMPONENTS	Black or White
TOP GUIDE	30mm
BOTTOM GUIDE	23mm

CUSTOM COLOUR SELECTION

Dulux Duralloy powder coated in NZ, matched to existing joinery

Choice of Two Headbox Series

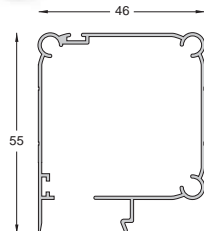
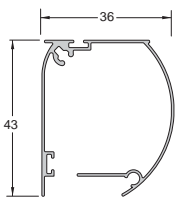

Series 36mm Headbox
for smaller openings

Series 46mm Headbox
for larger openings



Expandable mesh -
safety feature

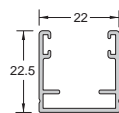

Bottom guide



Viscodynamic brake

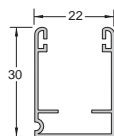

Side/Top guide





VALENTIA™ SLIDING INSECT SCREEN DOORS

Sliding insect screen doors are lightweight and economical, ideal for screening either aluminium or timber sliding door joinery. The low installation depth of the external tracks makes them very neat and versatile.

Valentia is the preferred insect screen solution in applications where wind gusts can be a problem for other types of screens.

A combination of strong aluminium corners and non-visible adjustable nylon bottom rollers make for a sturdy and smooth sliding insect screen. A slim-line matching vision rail helps prevent children from accidentally running into the screen. Powder coated aluminium frames are colour matched to your existing joinery. Infill options include pet resistant mesh and Look-Out™ One Way Vision Mesh.

CUSTOM MADE IN NZ

SPECIFICATIONS

MAX HEIGHT	2100mm
MAX WIDTH	1300mm
INSECT MESH	Juralco Fibreglass 17x14 Black, Pet Resistant or Look-Out™ One Way Vision Mesh
COLOURS	Standard colour selection Powder Coated Arctic White, Mid Bronze, Anodised Bronze and Anodised Silver

CUSTOM COLOUR SELECTION

Dulux Duralloy powder coated in NZ, matched to existing joinery



VALENTIA™ HINGED INSECT SCREEN DOORS

Hinged insect screen doors are a simple and convenient screening solution for both aluminium and timber doors. Valentia is the preferred insect screen solution in applications where wind gusts can be a problem for other types of screens.

A matching vision rail helps prevent children from accidentally running into the screen. A choice of either locking or non-locking pull handles can be colour matched along with the frame to your joinery. Automatic closing is popular with the addition of an optional pneumatic door closer. Other options include One Way Vision Mesh, pet mesh or a bottom kick rail to help protect the mesh from accidental damage.

CUSTOM MADE IN NZ

SPECIFICATIONS

MAX HEIGHT	2100mm
MAX WIDTH	1100mm
INSECT MESH	Juralco Fibreglass 17x14 Black, Pet Resistant or Look-Out™ One Way Vision Mesh
COLOURS	Standard colour selection Powder Coated Arctic White, Mid Bronze, Anodised Bronze and Anodised Silver

CUSTOM COLOUR SELECTION

Dulux Duralloy powder coated in NZ, matched to existing joinery



Venette pleated window screens are the perfect choice to complement your pleated retractable sliding door screens. Due to the increasing popularity of pleated mesh insect screens a choice of vertical or horizontal opening window screens are now available.

Featuring the same black pleated mesh as the Venette retractable door screens, Venette window screens are unobtrusive when in use and store away neatly when no longer needed. Side/top/bottom guides and Kevlar wires with a hidden tension system, retain the pleated mesh within the screen rails. Whilst integrated nylon runners at the end of bottom rails, ensure the screen is smooth and easy to operate.

Vertical and horizontal Venette window screens use an ergonomic handle, integrated into the bottom or side frames, for easy opening and closing. Horizontal opening screens have a unique centralised operation, allowing these to be opened from either side (left or right of the centre) and stopped in any position. They are ideal for large, wide windows that need the flexibility of a screen that can be operated from any position.

Venette window insect screen top/side guides, and handle rails are all powder coated in New Zealand, to match your existing joinery.

CUSTOM MADE IN NZ

SPECIFICATIONS

VERTICAL WINDOWS (1V)

MIN WIDTH 420mm **MAX WIDTH** (500-1000mm High) 1800mm
(1001-1800MM High) 1200mm

MIN HEIGHT 500mm **MAX HEIGHT** 1800mm

HORIZONTAL WINDOWS (1D)

MIN WIDTH 1000mm **MAX WIDTH** 3000mm

MIN HEIGHT 700mm **MAX HEIGHT** 1300mm

HEADRAIL & SIDE GUIDES 35mm

HEADRAIL CAPS & RAIL GUIDES Black Nylon

BOTTOM GUIDE 5mm (standard PC Black)

CUSTOM COLOUR SELECTION

Dulux Duralloy powder coated in NZ, matched to existing joinery

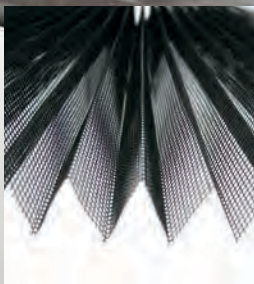

Pleated mesh



Integrated runners

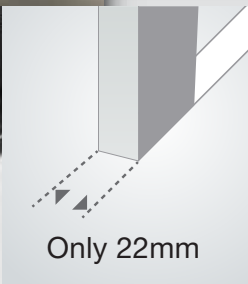

Only 22mm

Slim frame finish

Opening Configurations

1V VERTICAL OPENING

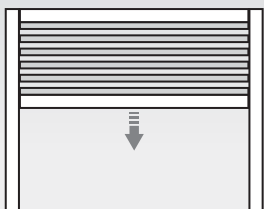

Profile

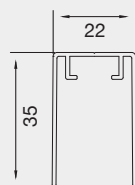

Top guide/side guide

1D HORIZONTAL CENTRALISED OPENING

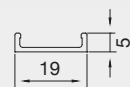
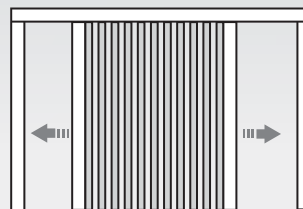

Bottom guide



Profile

MAGNETIC INSECT WINDOW SCREENS

Magnetic insect screens with their magnetic “snap shut” action are economical and versatile. Custom made and installed with a decorative cover strip that matches your existing joinery, pull tab handles prevent screen damage when opening or closing your windows.



CUSTOM MADE IN NZ

SPECIFICATIONS

MAX SIZE	1.0 square metres
INSECT MESH	Juralco Fibreglass 17x14 Black
COLOURS	Black, Brown, Grey, Off White, White, New Denim Blue, Ironsand, and Karaka

CUSTOM COLOUR SELECTION

Dulux Duralloy spray colour matched to existing joinery

ALUMINIUM FRAME INSECT WINDOW SCREENS



Hinged Insect Window Screens

HINGED INSECT SCREEN windows can be removed easily; through the use of an optional two piece hinging system, making cleaning and winter storage straight forward.



A Mohair seal protects joinery and prevents insects from getting in between little gaps.

Removable Hinge



Sliding Insect Window Screens

SLIDING INSECT SCREEN windows are effortless to open and close and can be simply removed if not required. Ideal for fitting to aluminium or timber joinery.

CUSTOM MADE IN NZ

SPECIFICATIONS

MAX SIZE	1.5 square metres
INSECT MESH	Juralco Fibreglass 17x14 Black

COLOURS Standard colour selection: Powder coated Arctic White, Mid Bronze, Anodised Bronze and Anodised Silver

CUSTOM COLOUR SELECTION

Dulux Duralloy powder coated in NZ, matched to existing joinery



Match your Genius retractable door with a similar window system. Retractable window screens are fitted with an attractive, matching headbox, so the insect screen can be rolled away neatly, when not required. With a choice of two head box systems, (36mm or 46mm) Genius retractable window screens combine modern Italian design with durable functionality.

A patented Viscodynamic brake is provided as a standard feature on all of our retractable window screens - preventing the screen from snapping shut during retraction. A mohair seal along the bottom rail prevents damage to the window sill. The head box, side channels and bottom rail are all powder coated in New Zealand to match your existing window joinery.



CUSTOM MADE IN NZ

SPECIFICATIONS

- MIN WIDTH** 500mm
- MAX WIDTH** S36 - 1500mm, S46 - 1800mm
- MIN HEIGHT** 500mm
- MAX HEIGHT** S36 - 1500mm, S46 - 2600mm
- SIDE GUIDES** 30mm
- ORIENTATION** Vertical or Horizontal
- CUSTOM COLOUR SELECTION**
Dulux Duralloy powder coated in NZ, matched to existing joinery



Fully Retracted Screen



Half Retracted Screen



Fully Closed Screen

10

REASONS TO CHOOSE AN AMPLIMESH INSECT SCREEN

- 1 ENJOY YOUR HOME MORE IN SUMMER**
Open up your home to let the fresh air in without disease carrying insects!
- 2 CUSTOM MADE PROTECTION**
Custom made to fit your window and door joinery exactly, in a wide choice of colour and configurations
- 3 DURABLE AND ENVIRONMENTALLY FRIENDLY**
Quality NZ made screens for years of chemical free insect protection
- 4 EASY CLEAN AND EASY CARE**
Hard wearing, easy clean materials for long life
- 5 INNOVATIVE PROTECTION**
Advanced and patented insect protection, with proven effectiveness from installations worldwide
- 6 TIMELESS DESIGN**
Unobtrusive, elegant top quality materials
- 7 EXPERT SERVICE AND INSTALLATION**
A wide range of screens and expert advice means the right screen selection
- 8 VALUE FOR MONEY**
Efficient local New Zealand production and installation and competitive prices
- 9 QUALITY FROM THE MARKET LEADER**
Amplimesh screens are sourced from Juralco, NZ largest supplier of insect screen systems
- 10 5 YEAR WARRANTY***
On aluminium, labour and parts (excluding mesh)



*For warranty terms and conditions see www.amplimesh.co.nz

To guarantee customer satisfaction and meet a high standard of quality Juralco Aluminium Systems are only available from the most highly qualified tradesmen. Authorised Amplimesh dealers are licenced to supply genuine Amplimesh Insect Screen Products. You can refer to the address here and be confident that you will have a service that matches the Amplimesh product quality.

The products in this brochure are the subject of intellectual property protection. All brands are either trademarks of Juralco Aluminium Building Products Ltd or used under licence.



Available from: