



# **JURALCO CLEARGUARD<sup>®</sup> SECURITY DOOR AND WINDOW SYSTEMS**

ISSUE 3-23 v1

**Juralco Aluminium Building Products Ltd designs and distributes specialist aluminium joinery systems through a national network of franchised fabricators and agents.**

**For more than 25 years we have been at the forefront of specialist aluminium door and window products suitable for New Zealand joinery and building methods. Our comprehensive product range includes security and insect screens, balustrades and gates, shutters and awnings, shower screens, wardrobe doors and organisers and internal doors.**

**Juralco Clearguard® Security doors and windows provide clear vision as well as insect protection and security to AS5041-2003 Impact and Knife shearing standards. The patented assembly method leaves the Heavy duty hardened punched aluminium sheet free from mechanical fixings such as screws, rivets and pins.**

**The system is suitable for use in a wide range of installations including residential, commercial, school door and window applications, hotel ,bar, club, vehicle and shop window protection screens. Doors are available in both sliding and hinged configurations and windows in sliding, hinged and fixed configurations. All are custom-made in a wide variety of frame powder-coat and anodised finishes and incorporate appropriate hardware.**

**Clearguard® Security Doors - Perforated Metal sheet**

Clear vision combined with insect screen, security and ventilation.  
Depending on colour and lighting this mesh is almost invisible.  
Set in a secure Door frame with optional 3 point security lockware.  
Available as hinged or sliding doors.

**Clearguard® Security Windows - Perforated Metal sheet**

Clear vision combined with insect screen, security and ventilation.  
Depending on colour and lighting this mesh is almost invisible.  
Set in a secure Window frame with security lockware.  
Available as fixed, hinged or sliding windows.



# Juralco Clearguard® Security Door and Window Systems - General Descriptions

**Note: Security Door tested to Australian Standard AS 5039 and A5504 (clause 7.2) Dynamic Impact Test**

## Index

Type	Pages	Description	<a href="#">Use the Bookmarks</a>  <a href="#">List to jump to selected pages</a>
General	4 - 5	General descriptions of Insect Window and Door types. Clearguard Perforated Panels.	
Windows	6 - 10	Shows Hinged and Sliding Security windows. Extrusions, components and cutting allowances	
Doors, Hinged	11 - 20	Shows Hinged Security doors. Extrusions, components and cutting allowances.	
	21 - 22	Worksheet - Security Hinged Single and Double Doors	
Doors, Sliding	23 - 33	Shows Sliding Security doors. Extrusions, components and cutting allowances	
	34 - 36	Worksheet - security Sliding Single and Double Doors	
Clearguard Panel Fitting	37 - 38	Shows how to fit Clearguard mesh to Window and Door frames	
Decorative Door Panels	39	Shows Decorative Panels and Fitting instructions	
Powder coat	40	Instructions for the care of Powder coated surfaces	

### Important information - Powder Coating systems.

**Powdercoat Systems** The new standard Dulux powder coating system used by Juralco is Duralloy Plus®. Also Duralloy® and Duratec®. Juralco Powder coated prices are for Duralloy Plus® and Duralloy® (same pricing). Duratec® prices on application. The following specs apply to Building Exteriors.

- Dulux Duralloy Plus® powder coating systems are suitable for properties greater than 10m from high tide level. Residential and Light commercial buildings, 3 levels max. Warranty 15 yrs
- Dulux Duratec® powder coating systems are suitable for properties greater than 10m from high tide level All Residential and Commercial buildings. Warranty 25 yrs.

**Attachment to structures** A PVC Tape or similar material spacer must be used to separate powder coated aluminium items from all concrete and steel structures. Failure to do so can lead to the chemicals in the structure affecting the powder coating, leading to corrosion.

**Swimming Pools** The chlorinated water in swimming pools can cause the deterioration of powder coated surfaces, leading to corrosion of the underlying surface. It is recommended that Powder coated surfaces be 1200mm min from a pool.

**Care** The Dulux powder coating warranty period is conditional upon the surface being maintained in accordance with the Dulux 'Care and Maintenance Instructions'. Download from Dulux or refer to the back page of this manual.

# Juralco Clearguard® Security Screen Door and Window Systems - Perforated Sheet

Clearguard Peforated Sheet

Please Note: Vertical striation lines are considered normal and are part of the manufacturing process and may be visible when viewed close up.

**Note: Security Door tested to Australian Standard AS 5039 and A55041 (clause 7.2) Dynamic Impact Test**

Specifications:

Combined Security and Insect Screen

Rigid perforated sheet, Hardened aluminium

Sheet 14g dia x 2.2mm holes

Visibility, % open area = 41%

Finish, Black Powdercoat

Sheet peforations, Full size

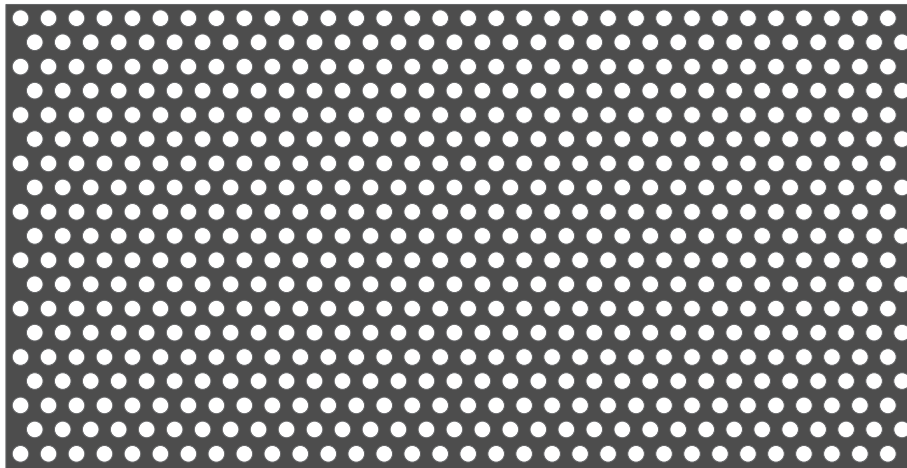

Clearguard Sheet Sizes

Approx Max Door Frame Size

Sheet	Width	Length	Width, max	Height, max
Part No	mm	mm	mm	mm
JCG/ALA/2.0	750	2000	840	2090
JCG/ALC/2.0	900	2000	990	2090
JCG/ALD/2.0	1200	2000	1280	2090
JCG/ALA/2.4	750	2400	840	2490
JCG/ALC/2.4	900	2400	990	2490
JCG/ALD/2.4	1200	2400	1280	2490

# Juralco Clearguard® Security Door and Window Systems - General Descriptions

## Clearguard Windows

- Juralco offers a wide range of options covering either fixed, hinged or sliding windows.
- All windows are constructed from our propriety range of aluminium extrusions.
- Available in a range of powdercoat colours to your design or natural anodised (frame only).
- A variety of Hardware to suit your security requirements.

Fixed Window Panels  
H max = 2000mm, W max 1200mm  
Hinged Window Panels  
H max = 1500mm, W max 1200mm  
Sliding Window Panels  
H max = 1500mm, W max 1200mm

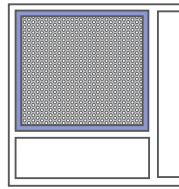

Fixed Windows

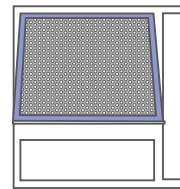

Hinged Windows

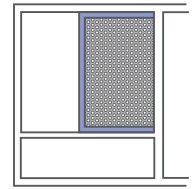

Sliding Windows

Single Awning

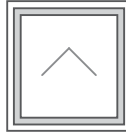

Can be top hinged, fixed or lift in and out. Inside fixing only.

Awning with Fixed Panel

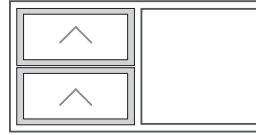

Sliding Screen covering both sashes or top hinged covering one sash. Inside fixing only.

Double Hung

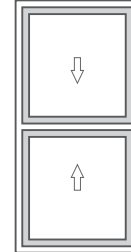

Fixed or lift in and out. Preferably on the outside.

Fixed Panel

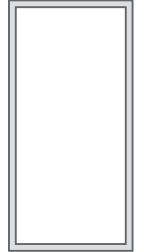

Fixed or side hinged either inside or out.

Sliding with Fixed Panel

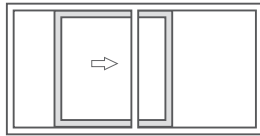

Either sliding on the inside or fixed on the outside

Casement

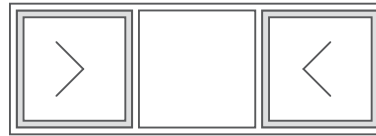

Side hinged, sliding or fixed. Inside fixing only.

## Clearguard Doors

- Juralco offers a wide range of options covering either hinged or sliding doors.
- All doors are constructed from our propriety range of aluminium extrusions.
- Available in a range of powdercoat colours to your design or natural anodised (frame only)
- A variety of Hardware to suit your security requirements.

All Door Panels  
H max = 2490mm, W max 1280mm

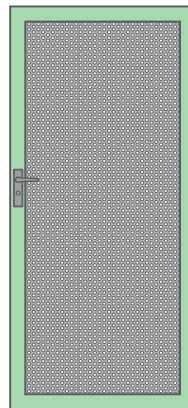

Hinged Door  
(Single and Double)

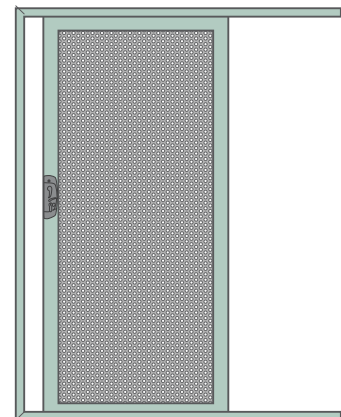

Sliding Door  
(Single and Double)

**Note:** Security Door tested to Australian Standard AS 5039 and A5504 (clause 7.2) Dynamic Impact Test

Timber Doors

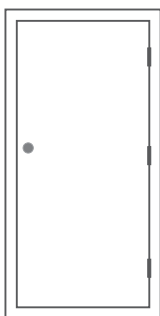

Most Security Doors will fit within the timber jamb.

Aluminium Doors

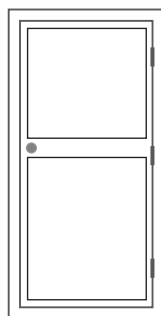

Security Doors will require an adaptor extrusion to clear the door handle.

Timber or Aluminium Doors with Glass Sidelight

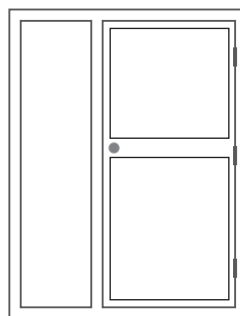

Will normally require building out the door mullion with dressed timber.

Timber or Aluminium Doors with Two Glass Sidelights

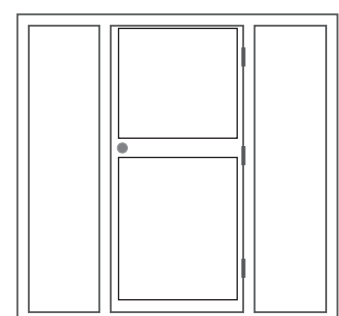

Will normally require building out the both door mullions with dressed timber.

**Juralco Clearguard® Security Door and Window Systems - Window Extrusions**

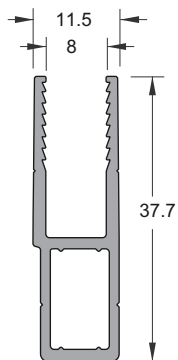

**CLEARGUARD  
WINDOW FRAME  
JCG7811/5**

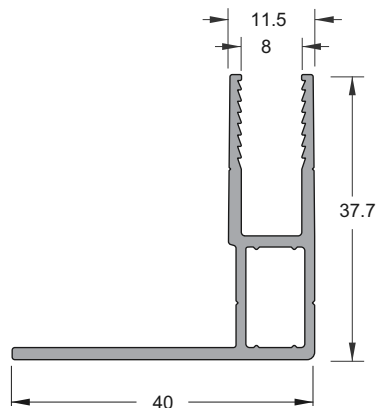

**CLEARGUARD WINDOW  
FRAME ANGLE  
JCG7814/5**

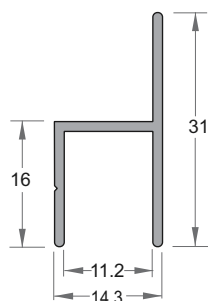

**SLIDING WINDOW  
TOP CHANNEL  
(with Leg)  
J5775/5**

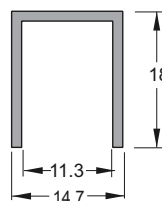

**SLIDING WINDOW  
TOP CHANNEL  
J5773/5**

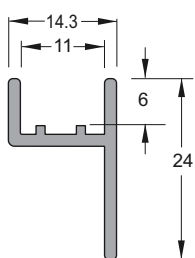

**SLIDING WINDOW  
BOTTOM CHANNEL  
(with Leg)  
J5774/5**

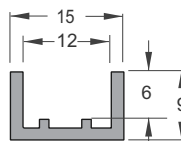

**SLIDING WINDOW  
BOTTOM CHANNEL  
J5772/5**

**Juralco Clearguard® Security Door and Window Systems - Window Components**

Butt Hinge 65mm  
JC240

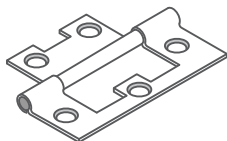

Corner Stake  
JCG/539

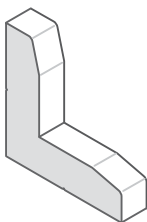

Nylon Runner  
JC284



Mohair Strip  
JC225

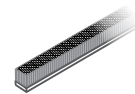

350mt Roll

Mighty Strong  
Window Presslock  
JJM194B

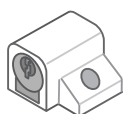

Black only

Whitco Window Presslock  
JJH22023 (B or W)

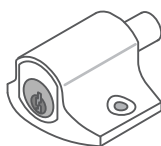

Black or White

Clearguard Plug  
JCGTape

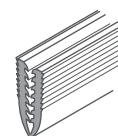

4mt Lengths

Whitco Mini  
Window Bolt 40mm  
JJH22033 (B or W)



Black or White

Whitco Sliding  
Window Presslock  
JJH22013B

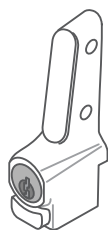

Black only

Whitco Window Multi Bolt  
JJH22053

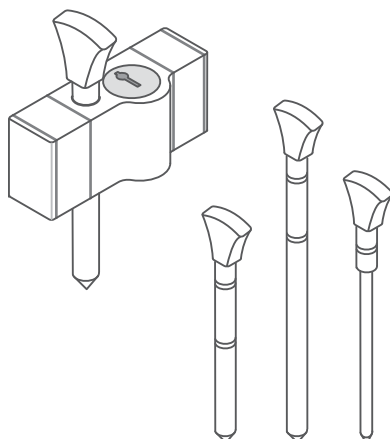

Black or White

Includes 3x Door Bolts

# Juralco Clearguard® Security Door and Window Systems - Window Details

## Ten Point Check List - Clearguard Security Window Measuring

- 1 - Decide what type of screen would be suitable for this installation.  
i.e. Sliding, Top Hinged, Side Hinged, Fixed or Lift In and Out.
- 2 - Measure opening height and width according to the type of screen to be fitted.
- 3 - Check distance of protruding handles or window stays to make sure the Window has enough fixing surface.
- 4 - Check existing blinds, curtains, pelmets and drapes to see that the Window will not catch if and when opened.
- 5 - Decide on suitable lock. Refer Juralco Security Hardware & Components Price List.
- 6 - Discuss colour finish required.
- 7 - Note any add ons - timber packers, build out angles, sliding channels.
- 8 - Don't leave the site until you are 100% sure the unit you have detailed will work.

### Clearguard Windows, Fixed - Reveal or Face Fix

This configuration can be used to add Security to any window opening. The Frame and Security Panel are lightweight and suitable for all environments.

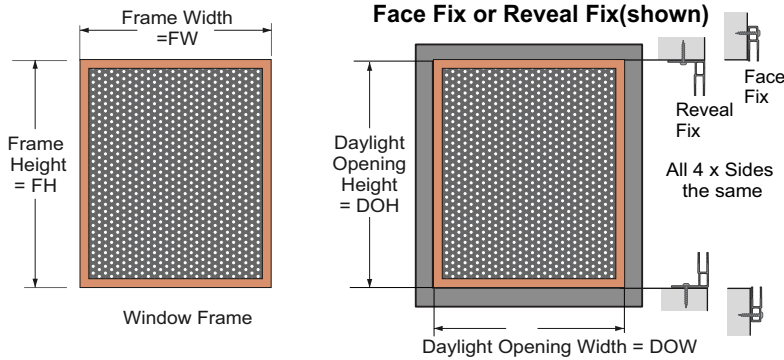

Window Frame  
J7811

Window Frame with  
Angle JCG7814

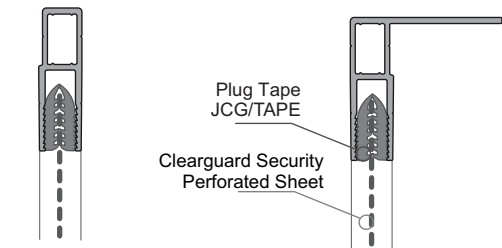

Face Fix

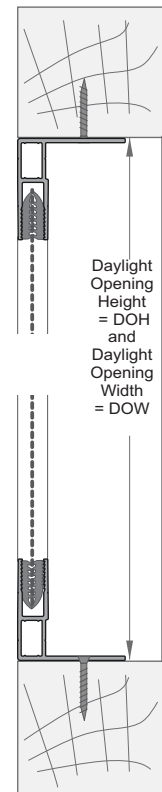

Reveal Fix

### CLEARGUARD SINGLE FIXED WINDOWS

FACE FIX		Part	Cutting Calc	No
1	Window Frame Height FH	JCG7811	$(DOH + 75) = FH$	2
2	Window Frame Width FW	JCG7811	$(DOW + 75) = FW$	2
REVEAL FIX		Part	Cutting Calc	No
1	Window Frame Height FH	JCG7814	$(DOH - 2) = FH$	2
2	Window Frame Width FW	JCG7814	$(DOW - 2) = FW$	2

### Select FH, FW from Face or Reveal Mounts

1	Clearguard Panel Height	JCG/AL	FH - 44	1
2	Co-extruded Plug Height	JCG Tape	FH - 82	2
1	Clearguard Panel Width	JCG/AL	FW - 44	1
2	Co-extruded Plug Width	JCG Tape	FW - 82	2

Components - always needed		Part	No
1	Window Frame Corner Stake	JCG/539	4

Cutting calculations - These are a guide only, confirm before cutting  
Strongly Recommended - Allow +30mm per cut to allow for Trimming/Mitre cuts and on site adjustment



**Clearguard Windows - Hinged Reveal Fix only**

This configuration can be used to add Security to any window opening. The Frame and Security Panel are lightweight and suitable for all environments.

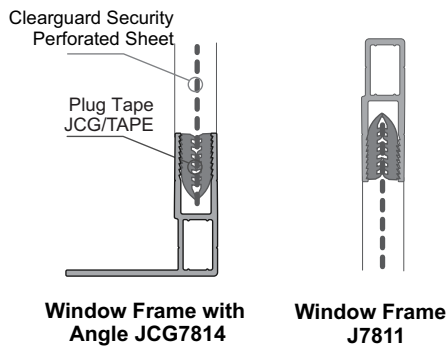
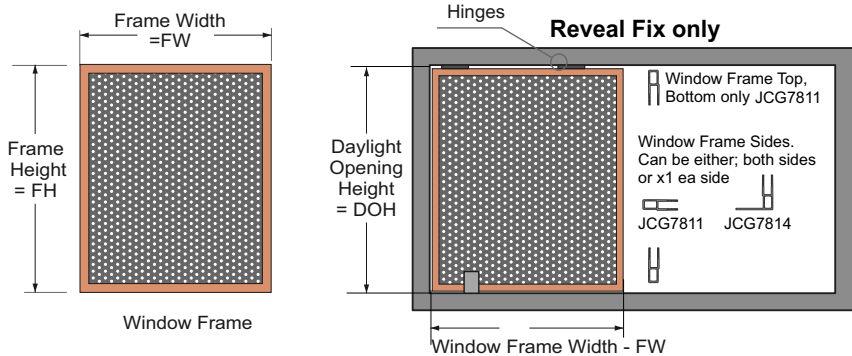

**CLEARGUARD SINGLE HINGED (Awning) WINDOWS**

	<b>REVEAL FIX</b>	<b>Part</b>	<b>Cutting Calc</b>	<b>No</b>
1	Window Frame Height FH	JCG7814 or JCG7811	$(DOH - 10) = FH$	2
2	Window Frame Width FW	JCG7811	Enter FW	2
1	Clearguard Panel Height	JCG/AL	$FH - 44$	1
2	Co-extruded Plug Height	JCG Tape..	$FH - 82$	2
1	Clearguard Panel Width	JCG/AL	$FW - 44$	1
2	Co-extruded Plug Width	JCG Tape	$FW - 82$	2

	<b>Components - always needed</b>	<b>Part</b>	<b>No</b>
1	Window Frame Corner Stake	JCG/539	4
2	Mighty Strong Hinge 65mm	JC240	2
Select 1 x appropriate Window Presslock			
1	Mighty Strong Presslock (Black)	JJM194B	1
2	Whitco Presslock (Black or White)	JJH22023	
3	Whitco Minibolt (Black or White)	JJH22033	

**Cutting calculations** - These are a guide only, confirm before cutting  
 Strongly Recommended - Allow +30mm per cut to allow for Trimming/Mitre cuts and on site adjustment

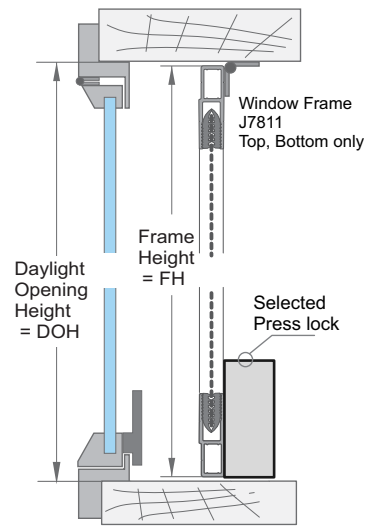

**Reveal Fix only**

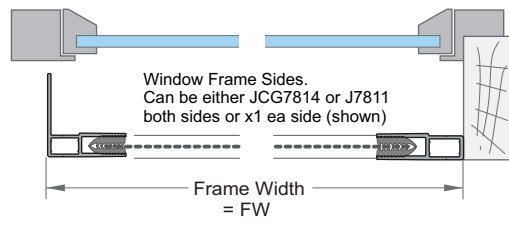

# Juralco Clearguard® Security Door and Window Systems - Window Details

## Clearguard Windows - Sliding Reveal or Face Fix

This configuration can be used to add Security to any window opening. The Frame and Security Panel are lightweight and suitable for all environments.

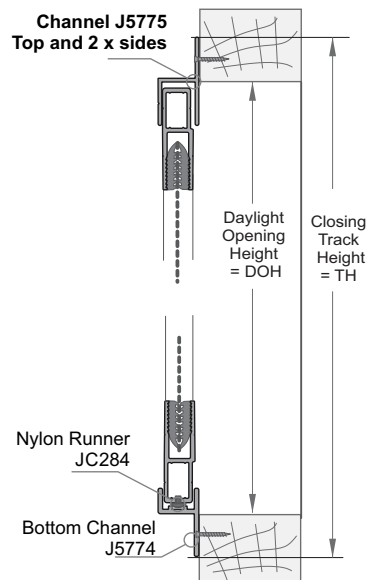
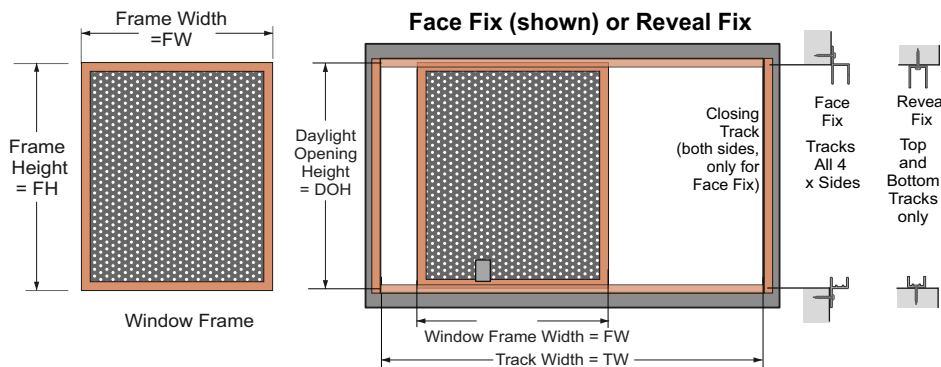
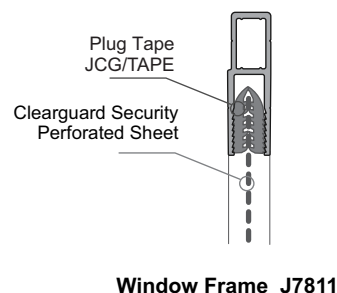
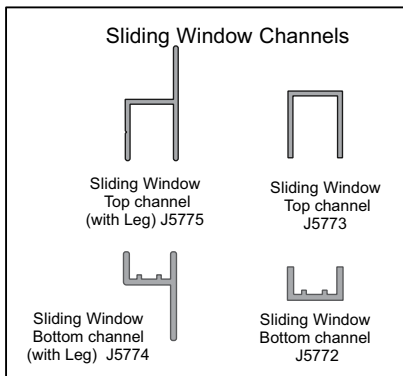

Face Fix

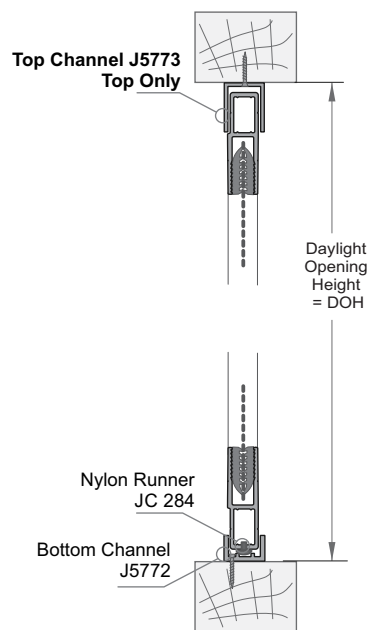

Reveal Fix

### CLEARGUARD SINGLE SLIDING WINDOWS

FACE FIX				
	Part	Cutting Calc	No	
1	Window Frame Height FH	JCG7811	$(DOH - 6) = FH$	2
2	Closing Track Height TH	J5775	$(DOH + 30) = TH$	2
3	Window Frame Width FW	JCG7811	Enter FW	2
4	Track Widths TW	J5775, J5774	Enter TW	1ea

REVEAL FIX				
	Part	Cutting Calc	No	
1	Window Frame Height FH	JCG7811	$(DOH - 6) = FH$	2
2	Window Frame Width FW	JCG7811	Enter FW	2
3	Track Widths TW	J5773, J5772	Enter TW	1ea

1	Clearguard Panel Height	JCG/AL	FH - 44	1
2	Co-extruded Plug Height	JCG Tape	FH - 82	2
1	Clearguard Panel Width	JCG/AL	FW - 44	1
2	Co-extruded Plug Width	JCG Tape	FW - 82	2

Components - always needed		Part	No
1	Window Frame Corner Stake	JCG/539	4
2	Nylon Runner	JC284	4
Select 1 x appropriate Window Lock			
1	Whitco Sliding Presslock (Black)	JJH22013B	1
2	Mighty Strong Presslock (Black)	JJM194B	
3	Whitco Window Presslock (Black or White)	JJH22023	
4	Whitco Minibolt (Black or White)	JJH22033	

Cutting calculations - These are a guide only, confirm before cutting  
Strongly Recommended - Allow +30mm per cut to allow for Trimming/Mitre cuts and on site adjustment

**Juralco Clearguard® Security Door and Window Systems - Hinged Door Extrusions**

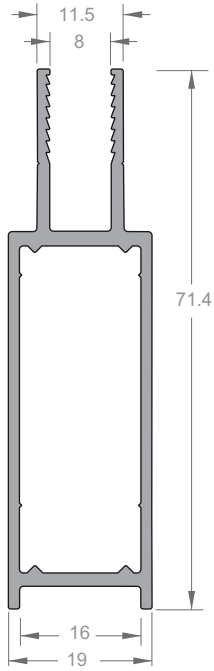

**DOOR FRAME**  
JCG/8295

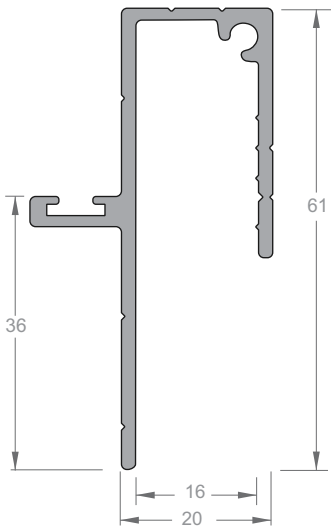

**HINGED DOOR ADAPTOR**  
J7467

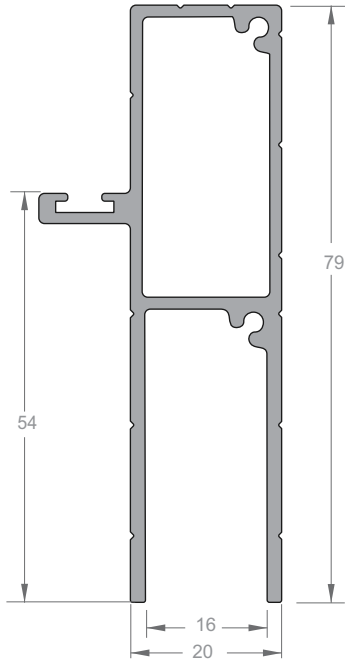

**HINGED DOOR BUILDOUT 54mm**  
J7465

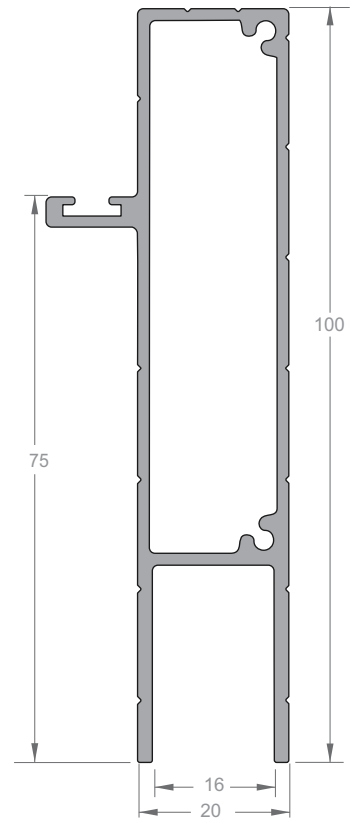

**HINGED DOOR BUILDOUT 75mm**  
J7466

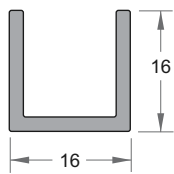

**BASE CHANNEL**  
J7470

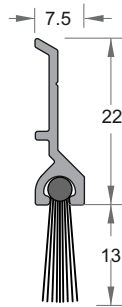

**DOOR SEAL**  
(with 13mm Mohair)  
JA186

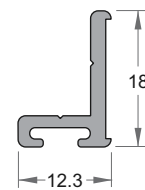

**CLOSING ANGLE**  
J3737

# Juralco Clearguard® Security Door and Window Systems - Hinged Door Components

## Hinged Door Locks Elegance + Elegance HD14

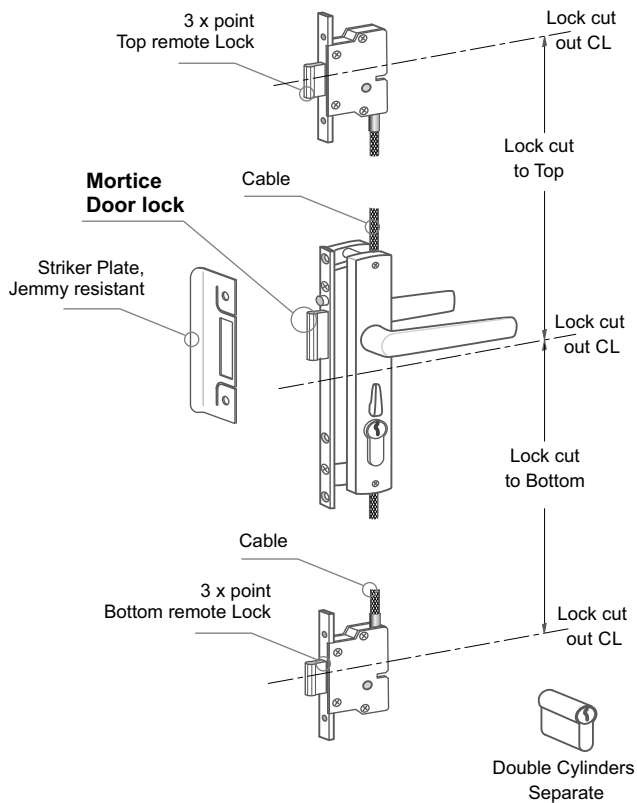

### Hinged Security Doors

- a - This lock can be used for RH or LH hinged doors
- b - Standard, Mortice, Centre only or Three point Lock Cable Drive, Top and Bottom Remote locks
- c - Available in three different center line combinations

Refer to instructions in kit for more information

## Hinged Door Locks Ultimate + Ultimate HD 16

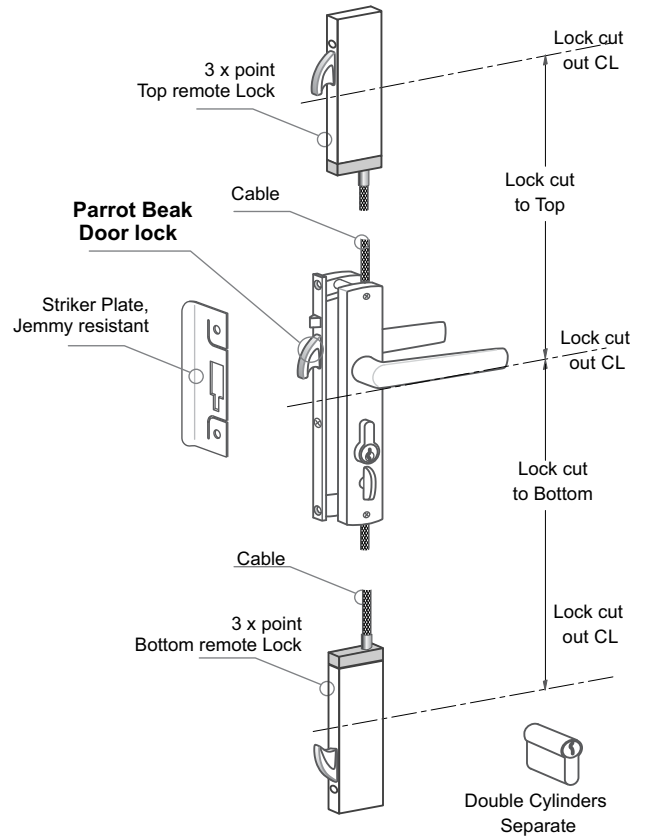

### Hinged Security Doors

- a - This lock can be used for RH or LH hinged doors
- b - Standard, Parrot beak, Centre only or Three point Lock Cable Drive, Top and Bottom Remote locks
- c - Available in three different center line combinations

Refer to instructions in kit for more information

### Hinge JC242

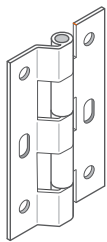

Available Zinc plated steel, or SS

### Staking Angle, Heavy Duty JC216

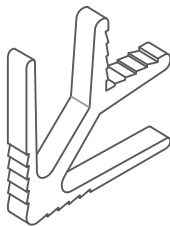

### Mohair Strip JC225

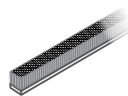

350mt Roll

### Door Closer JJMDCH

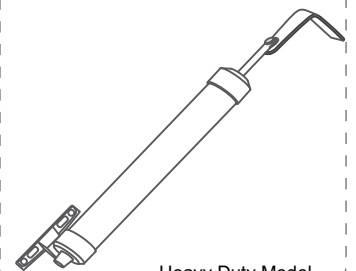

Heavy Duty Model

### Clearguard Plug JCGTape

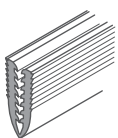

4mt Lengths

### Whitco Flush Bolt JJH203817 1 x 150mm Rod

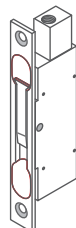

For Double Hinged Doors - Black only

### Ausloc Double Flush Bolt 2 x 1500mm Rods

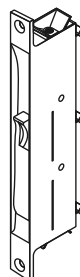

For Double Hinged Doors - Black only

### Snib Protector



JD100POLY  
230mm H  
x 110mm W

JD100  
290mm H  
x 144mm W  
White or SCC

# Juralco Clearguard® Security Door and Window Systems - Hinged Door, General

## Clearguard Hinged Door Recommendations

- 1 - **Frame** - Heavy duty Door Frame PN 8295
- 2 - **Corner Joints** - Use Heavy duty PN JC 216 corner stake .  
After assembling the frame the door should stay completely rigid.
- 3 - **Locks** - We recommend 3 point Austral Elegance or Austral Ultimate for higher security.
- 4 - **Hinges** - Clearguard Security screen doors should be fitted with inter-locking security hinges to prevent removal of the door if the hinge pin is removed.  
Hinge pins should be peened at the top and bottom
- 5 - **Fasteners** - High strength, stainless steel rivets to be used for fastening corner stakes and hinges to frame.  
Size and application of rivets must allow no movement between parts. Stainless steel 8-gauge fixing screws can be used as an alternative. The heads of all fasteners must be concealed to restrict access from outside when the door is closed.

For reveal mounting only, on the interior or exterior.

Note - This configuration can be used to add security to any Door opening. The frame and Clearguard security sheet are lightweight and suitable for all environments.

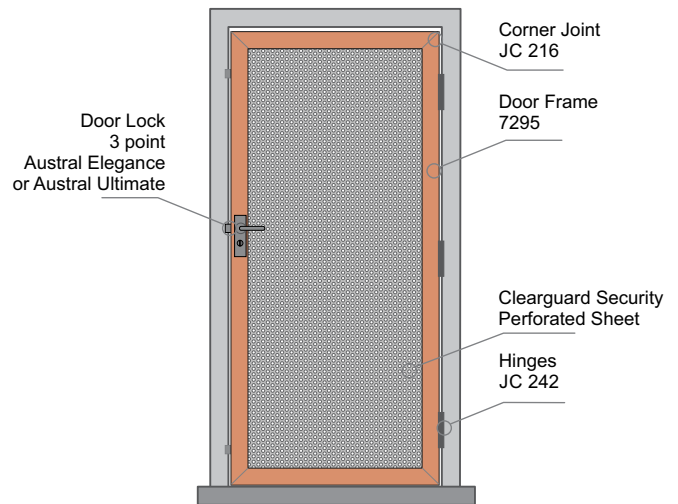

## Clearguard Hinged Door Measuring

### Check list for measuring up a Security Door

- 1 - **Door frame opening width** to be measured at 3 points, A, B and C. Record smallest measurement as the daylight width opening. Check for any bow in jambs.
- 2 - **Door frame opening height** to be measured at 2 points, D and E. Record smallest measurement as the daylight height opening. Check for any bow in sill or step.
- 3 - **Door Frame Diagonals F and G** to be measured to assess squareness of frame.
- 4 - **Height of furniture H**, on main door to be measured to ensure no interference with security door handles. Also check on space between doors for handle clearance. Check protruding measurement of existing door handle to see there is still enough space (25mm) to fit the security door within the jamb. Note most aluminium hinged glass doors require a 7465 adaptor build out section.
- 5 - **Check** which way door is to be hung, RH or LH. Note most suitable side for security door to be hinged. Generally it is hinged the same as the ensitu door but in some applications access is better if the security door is hinged opposite to ensitu door.
- 6 - **Check** thickness of stop bead T. Stepped striker plates and hinge leaves have a step dimension of 12mm to mate with the stop bead. If the door does not have a suitably positioned stop bead then a 3737 closing angle will be required.
- 7 - **Check** around doorway to see there are no protruding fuse boxes or hanging lights to stop security door from fully opening.
- 8 - **Check** to see that there are no door knockers or door bells that may require relocating before security door could be installed.
- 9 - **Check** that the Security door will clear the door mat (mainly a problem in concrete floor / aluminium door installations).
- 10 - **Check** colour finish of security door and mesh.
- 11 - **Check** for any extras - automatic door closer ....

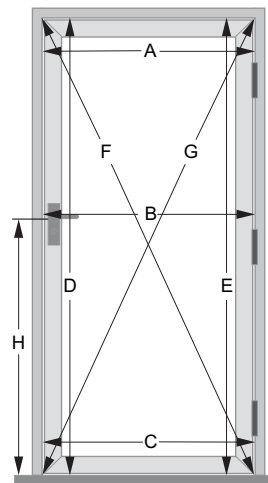

Door - 7 x Measure points

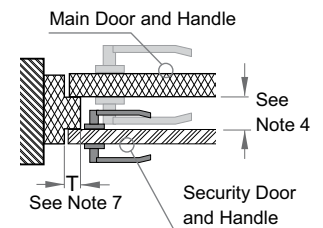
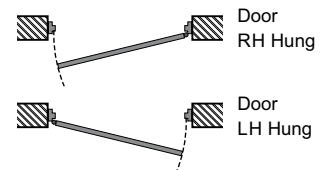

# Juralco Clearguard® Security Door and Window Systems - Hinged Door, Cutting

Clearguard Single Hinged Door  
Reveal Mount

(A)



Door Frame JCG/8295

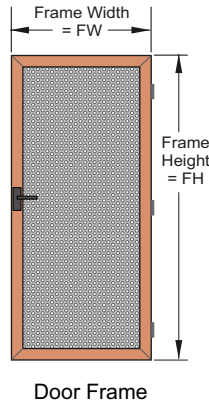
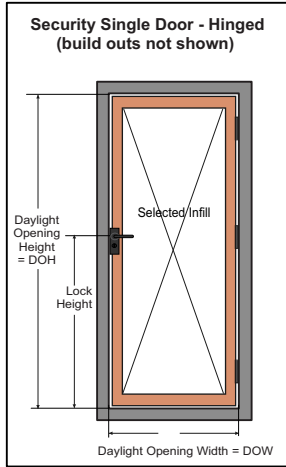

Door Frame

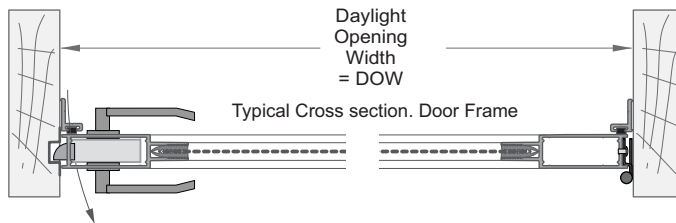
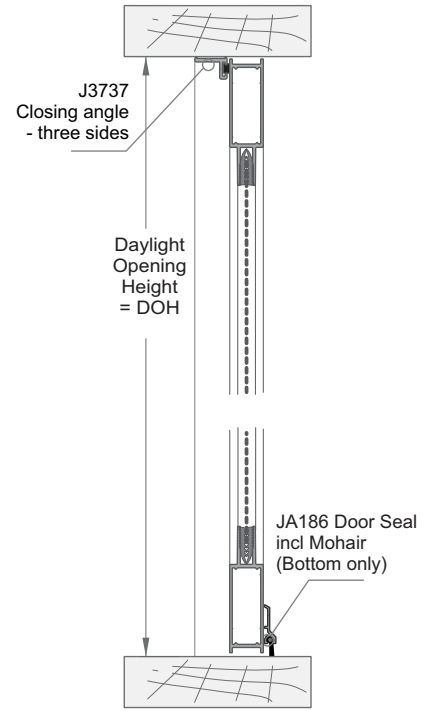

## CLEARGUARD SINGLE HINGED DOOR Reveal Mount

	HEIGHTS, WIDTHS	Part	Cutting Calc	No
1	Door Frame Height FH	JCG8295	$(DOH - 6) = FH$	2
2	Closing Angle Height	J3737	DOH	2
3	Woolpile Height	JC225	DOH	2
1	Door Frame Width FW	JCG8295	$(DOW - 6) = FW$	2
2	Closing Angle Width	J3737	$DOW - 15$	1
3	Woolpile Width	JC225	$DOW - 15$	1
1	Clearguard Panel Height	JCG/AL	$FH - 111$	1
2	Co-extruded Plug Height	JCG Tape	$FH - 149$	2
1	Clearguard Panel Width	JCG/AL	$FW - 111$	1
2	Co-extruded Plug Width	JCG Tape	$FW - 149$	2
3	Door seal incl Mohair Width	JA186	FW	1

## Components, always needed

	Description	Part	No
1	75mm Strong Hinge	JC242	3
2	Heavy Duty Corner Stake	JC216	4

**+ Security Hinged Door Locks**  
**(Identical for all Hinged Security Doors)**  
Choice of Austral Elegance, Austral Ultimate  
Whitco Tasman Mk2, Lockwood 8564  
Associated Cylinders, Multipoint Kits and  
Black, White, SCC as appropriate  
All as per Feb 2020 Price Book

**Cutting calculations** - These are a guide only, confirm before cutting  
Strongly Recommended - Allow +30mm per cut to allow for Trimming/Mitre  
cuts and on site adjustment

# Juralco Clearguard® Security Door and Window Systems - Hinged Door + Adaptor, Cutting

Clearguard Single Hinged Door + Adaptor

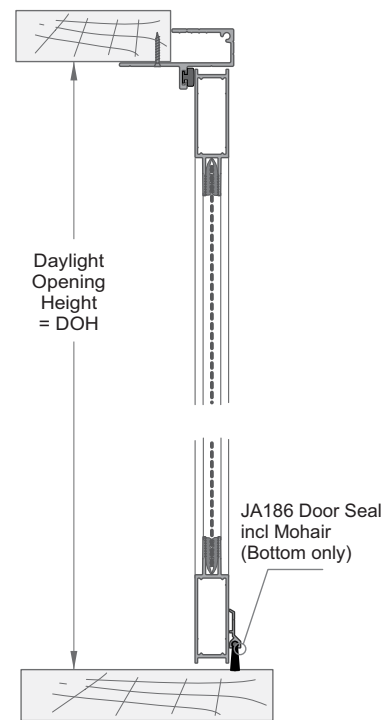
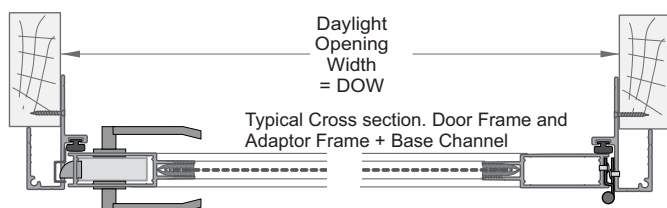
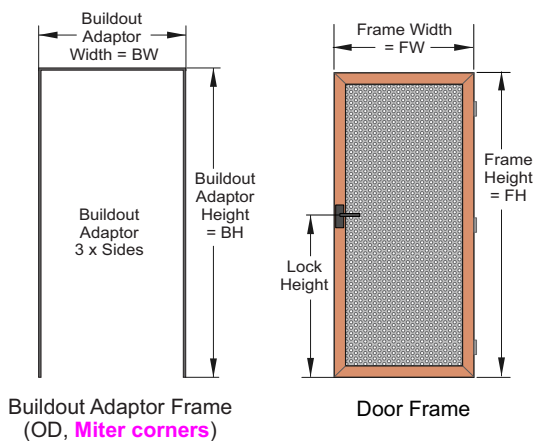
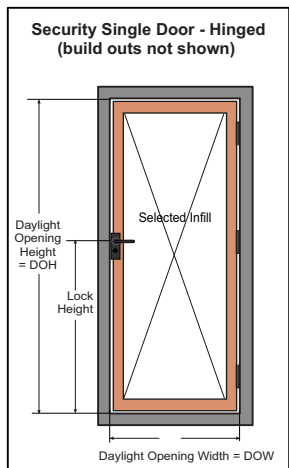

## CLEARGUARD SINGLE HINGED DOOR + Adaptor J7467 x 3 sides

	HEIGHTS, WIDTHS	Part	Cutting Calc	No
1	Buildout Adaptor Height BH	J7467	$(DOH + 20) = BH$	2
2	Woolpile Height	JC225	$DOH + 20$	2
3	Door Frame Height FH	JCGS/8295	$(DOH - 8) = FH$	2
1	Buildout Adaptor Width BW	J7467	$(DOW - 40) = BW$	1
2	Woolpile Width	JC225	$DOW + 40$	1
3	Door Frame Width FW	JCGS/8295	$(DOW - 12) = FW$	2
1	Clearguard Panel Height	JCG/AL...	$FH - 111$	1
2	Co-extruded Plug Height	JCG Tape..	$FH - 149$	2
1	Clearguard Panel Width	JCG/AL..	$FW - 111$	1
2	Co-extruded Plug Width	JCG Tape...	$FW - 149$	2
3	Door seal incl Mohair Width	JA186	FW	1

## Components, always needed

	Description	Part	No
1	75mm Strong Hinge	JC242	3
2	Heavy Duty Corner Stake	JC216	4

**+ Security Hinged Door Locks (Identical for all Hinged Security Doors)**  
 Choice of Austral Elegance, Austral Ultimate Whitco Tasman Mk2, Lockwood 8564 Associated Cylinders, Multipoint Kits and Black, White, SCC as appropriate  
 All as per Feb 2020 Price Book

Cutting calculations - These are a guide only, confirm before cutting  
 Strongly Recommended - Allow +30mm per cut to allow for Trimming/Mitre cuts and on site adjustment

# Juralco Clearguard® Security Door and Window Systems - Hinged Door+ Buildout , Cutting

Clearguard Single Hinged Door + Build outs

(C)

Door Frame JCG/8295

Hinged Door Buildout 54mm J7465

OR

Hinged Door Buildout 75mm J7466

Security Single Door - Hinged (build outs not shown)

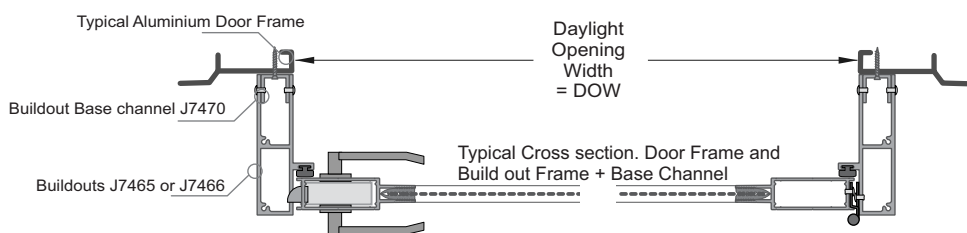
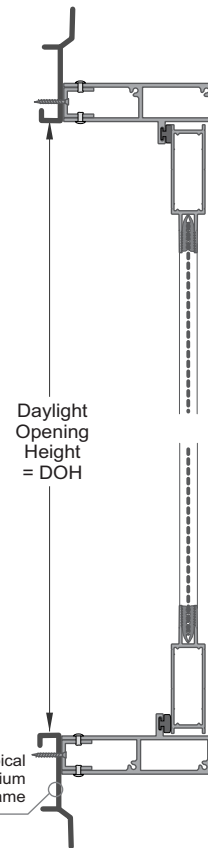
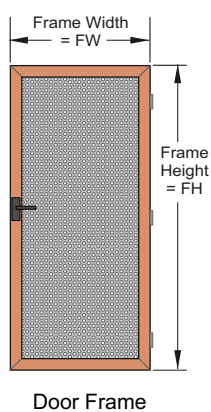
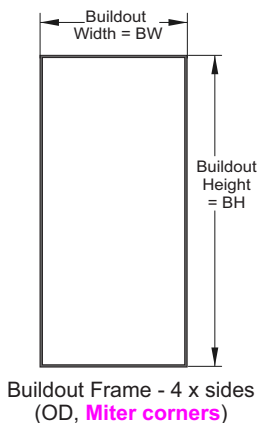
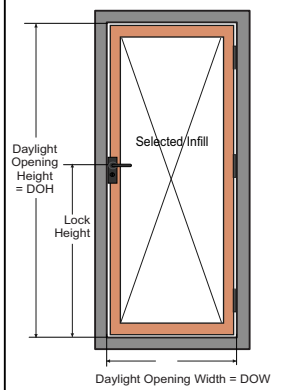

## CLEARGUARD SINGLE HINGED DOOR + J7465 or J7466 Buildouts x 4 sides

## Components, always needed

HEIGHTS, WIDTHS		Part	Cutting Calc	No
1	Buildout Height BH	J7465, J7466	(DOH + 40) = BH	2
2	Woolpile Height	JC225	DOH + 40	2
3	Buildout Base channel Height	J7470	DOH	2
4	Door Frame Height FH	JCGS/8295	(DOH - 6) = FH	2
1	Buildout Width BW	J7465, J7466	(DOW + 40) = BW	2
2	Woolpile Width	JC225	DOW + 40	2
3	Buildout Base channel Width	J7470	DOW	2
4	Door Frame Width FW	JCGS/8295	(DOW - 6) = FW	2
1	Clearguard Panel Height	JCG/AL...	FH - 111	1
2	Co-extruded Plug Height	JCG Tape..	FH - 149	2
1	Clearguard Panel Width	JCG/AL..	FW - 111	1
2	Co-extruded Plug Width	JCG Tape...	FW - 149	2

Description	Part	No
1 75mm Strong Hinge	JC242	3
2 Heavy Duty Corner Stake	JC216	4

### + Security Hinged Door Locks

(Identical for all Hinged Security Doors)

Choice of Austral Elegance, Austral Ultimate Whitco Tasman Mk2, Lockwood 8564 Associated Cylinders, Multipoint Kits and Black, White ,SCC as appropriate All as per Feb 2020 Price Book

Cutting calculations - These are a guide only, confirm before cutting  
Strongly Recommended - Allow +30mm per cut to allow for Trimming/Mitre cuts and on site adjustment



JURALCO

www.juralco.co.nz ph (09) 478 8018

Juralco Clearguard® Security Door and Window Systems

Issue 3-23 v1  
Page 16



# Juralco Clearguard® Security Door and Window Systems - Hinged Double Door, Cutting

Clearguard Double Hinged Door  
Reveal Mount

(A)



Door Frame JCG/8295

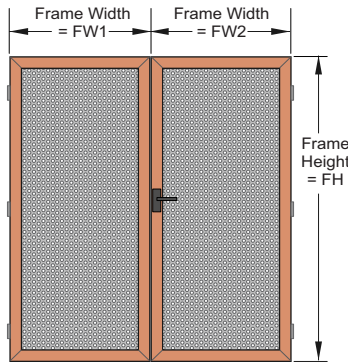
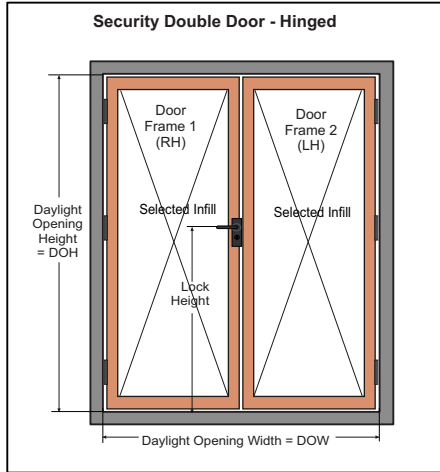

Door Frames  
Door Widths can be  
Equal or Unequal

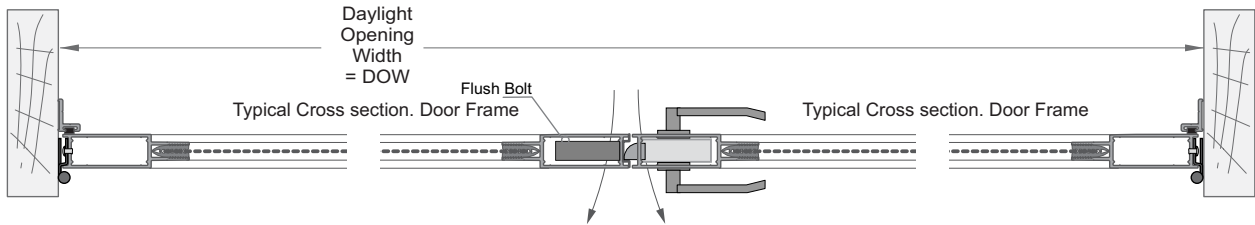
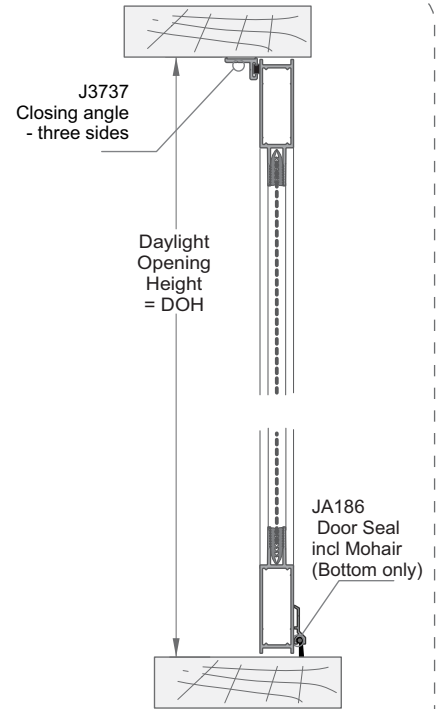

## CLEARGUARD DOUBLE HINGED DOOR Reveal Mount

Door Widths can be Equal or Unequal

	HEIGHTS, WIDTHS	Part	Cutting Calc	No
1	Door Frame Height FH	JCGS/8295	$(DOH - 6) = FH$	4
2	Closing Angle Height	J3737	DOH	2
3	Interlock Height	J9716	DOH	1
4	Woolpile Height	JC225	DOH	3
1	Door Frame Width <b>EQUAL</b>	JCGS/8295	$(DOW - 12) / 2 = FW$	4
2	Door Frame Width <b>Unequal</b> FW1		Enter Width FW1	2
3	Door Frame Width <b>Unequal</b> FW2		$(DOW - FW1 - 12) = FW2$	2
4	Closing Angle Width	J3737	DOW - 15	1
5	Woolpile Width	JC225	DOW - 15	1

1	Clearguard Panel Height	JCG/AL	FH - 111	2
2	Plug Height	JCG Tape..	FH - 149	4
1	Clearguard Panel Width	JCG/AL	FW(1,2) - 111	2
2	Co-extruded Plug Width	JCG Tape	FW(1,2) - 149	4
3	Door seal incl Mohair Width	JA186	FW(1,2)	1 ea

Cutting calculations - These are a guide only, confirm before cutting  
Strongly Recommended - Allow +30mm per cut to allow for Trimming/Mitre cuts and on site adjustment

## Components, always needed

	Description	Part	No
1	75mm Strong Hinge	JC242	6
2	Heavy Duty Corner Stake	JC216	8
Select either Flushbolts			
3	Whitco Single Flushbolt	JJH203817	2
4	Austral Double Flushbolt, with Rods	JJMFlushbolt/BLK	1

## + Security Hinged Door Locks

(Identical for all Hinged Security Doors)

Choice of Austral Elegance, Austral Ultimate

Whitco Tasman Mk2, Lockwood 8564

Associated Cylinders, Multipoint Kits and

Black, White ,SCC as appropriate

All as per Feb 2020 Price Book

# Juralco Clearguard® Security Door and Window Systems - Hinged Double Door, Cutting

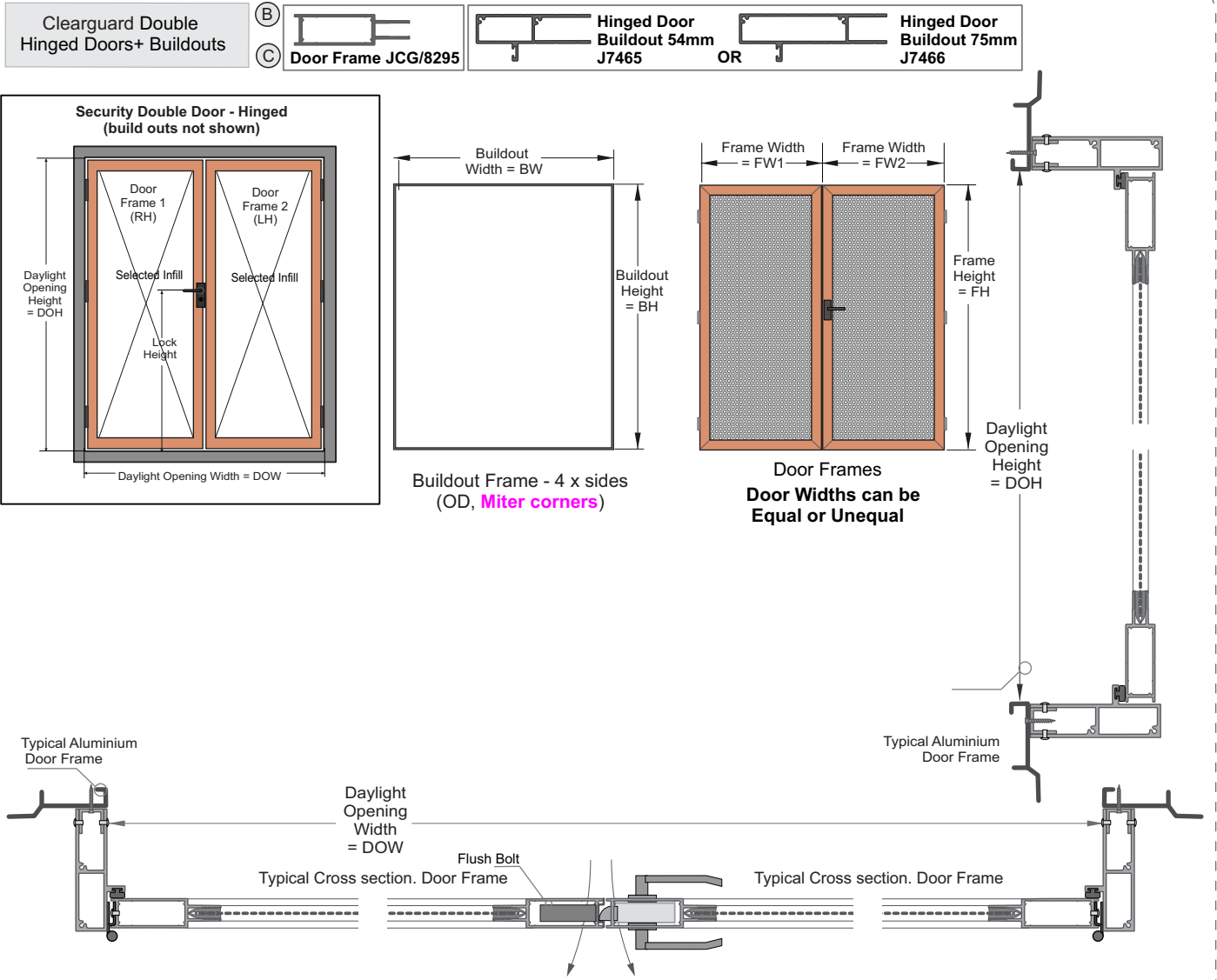

**CLEARGUARD DOUBLE HINGED DOORS**  
**+ Buildouts J7465 or J7466 x 4 sides**  
**Door Widths can be Equal or Unequal**

HEIGHTS, WIDTHS	Part	Cutting Calc	No
1 Buildout Height BH	J7465 or J7466	(DOH + 40) =BH	2
2 Woolpile Height	JC225	DOH + 40	2
3 Buildout Base channel Height	J7470	DOH	2
4 Door Frame Height FH	JCGS/8295	(DOH - 6)=FH	4
1 Buildout Width BW	J7465 or J7466	(DOW + 40) =BW	2
2 Woolpile Width	JC225	DOW + 40	2
3 Buildout Base channel Width	J7470	DOW	2
4 Door Frame Width <b>EQUAL</b>	JCGS/8295	(DOW-12)/2 = FW	4
5 Door Frame Width <b>Unequal</b> FW1		Enter Width FW1	2
6 Door Frame Width <b>Unequal</b> FW2		(DOW-FW1-12) =FW2	2
1 Clearguard Panel Height	JCG/AL...	FH - 111	2
2 Co-extruded Plug Height	JCG Tape..	FH - 149	4
1 Clearguard Panel Width	JCG/AL..	FW(1,2) - 111	2
2 Co-extruded Plug Width	JCG Tape...	FW(1,2) - 149	4

**Components, always needed**

Description	Part	No
1 75mm Strong Hinge	JC242	6
2 Heavy Duty Corner Stake	JC216	8
Select either Flushbolts		
3 Whitco Single Flushbolt	JJH203817	2
4 Austral Double Flushbolt, with Rods	JJMFlushbolt/BLK	1

**+ Security Hinged Door Locks**  
**(Identical for all Hinged Security Doors)**  
 Choice of Austral Elegance, Austral Ultimate  
 Whitco Tasman Mk2, Lockwood 8564  
 Associated Cylinders, Multipoint Kits and  
 Black, White ,SCC as appropriate  
 All as per Feb 2020 Price Book

**Cutting calculations** - These are a guide only, confirm before cutting  
 Strongly Recommended - Allow +30mm per cut to allow for Trimming/Mitre cuts and on site adjustment

# Juralco Clearguard® Security Door and Window Systems - Hinged Door, Machining

## Clearguard Hinged Door Machining

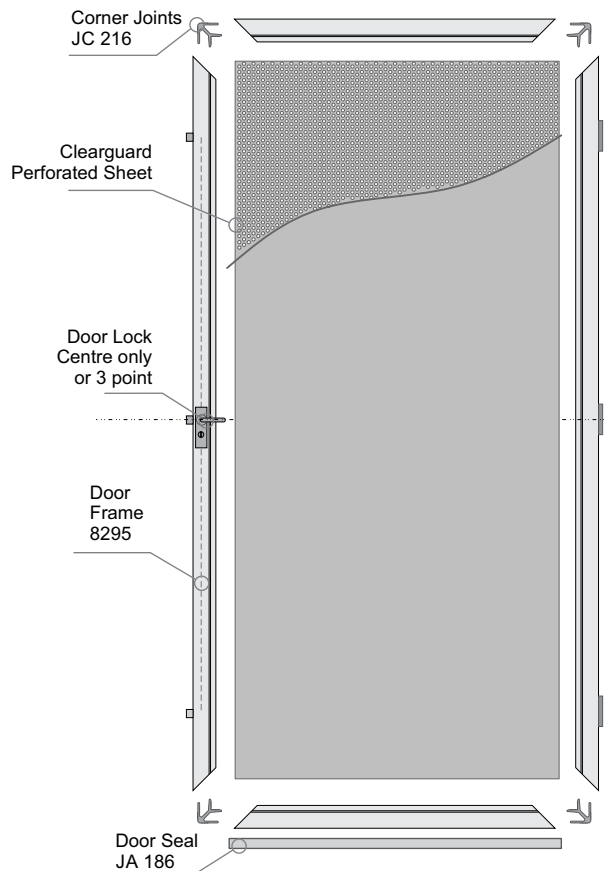

**Hinged Clearguard Security Doors - Lock Selection**  
Centre only or Three point Lock, Cable Drive.  
Mortice or Parrot Beak

## Elegance Door Frame Machining

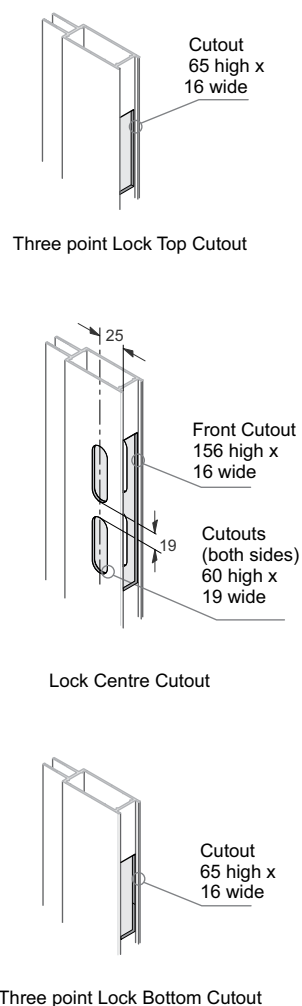

## Ultimate Door Frame Machining

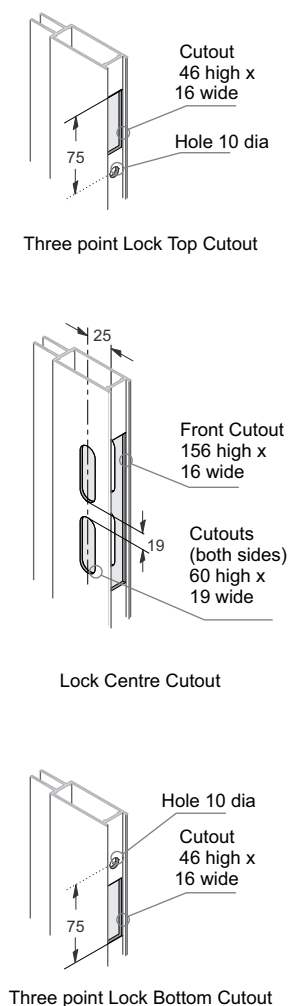

## Elegance, Ultimate Door Frame Machining Setouts

<b>Elegance, HD14</b>	A dim	B dim
Machining setouts	to Top	to Bottom
High centre Lock	682	826
Low Centre Lock	826	682
Pool Centre Lock	375	961
Set out tolerances all +/- 3mm		

<b>Ultimate, HD16</b>	C dim	D dim
Machining setouts	to Top	to Bottom
High centre Lock	610	790
Low Centre Lock	766	634
Pool Centre Lock	313	1079
Set out tolerances all +/- 3mm		

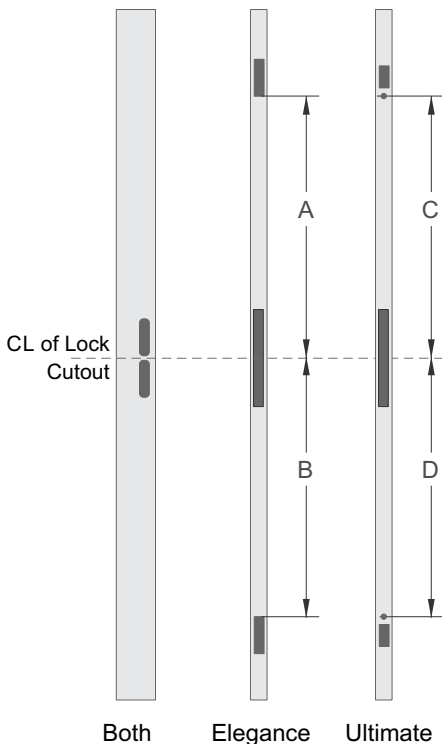

## Elegance, Ultimate Cylinders, Striker Plates

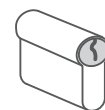

Double Cylinders  
Ordered Separately

**Elegance, AA-C4**  
5 pin double cylinder

**Ultimate, AA8-C4**  
5 pin double cylinder  
Ultimate Cylinders must include a cam stop spring

A range of different Striker Plates is available.  
- 7 for the Elegance,  
- 6 for the Ultimate.  
Refer manufacturers catalog



**JURALCO**

www.juralco.co.nz ph (09) 478 8018

**Juralco Clearguard® Security Door and Window Systems**

Issue 3-23 v1  
Page 19

### Clearguard Hinged Door Installation

- 1 - Check door fits into reveal and the door has been made to site measurements.
- 2 - Lift the door with 3mm packer on step to give clearance at the bottom.
- 3 - Screw the top & bottom hinge to the reveal with 1 screw in the middle hole of the hinge.
- 4 - Check the door swings correctly and fits into the reveal. If the door catches on the handle/lock side, check the hinges into the reveal.
- 5 - Screw the striker plate to the reveal in line with the door lock.
- 6 - Use a 3mm twist drill to drill out the rebate for the lock.  
Chisel the remainder of the timber out of the lock rebate.
- 7 - Screw the closing angle onto the reveal when the door is closed.  
If the closing angle catches the door handle, the closing angle will need to be cut away to clear the handle.
- 8 - Paint the exposed edge with the appropriate colour.
- 9 - Always clean off all fingermarks, leave the site clean and tidy.

### Clearguard Hinged Door Build out Installation

- 1 - The Adaptor box is manufactured and installed first; the security door is then hung from it.
- 2 - Check the door is the correct size for the application.
- 3 - Measure the internal width of the build out frame to determine the size and setout for the base channel brackets (BCB).
- 4 - The BCB (8 per door) are screwed to the existing door frame. 1 x each Top and Bottom, 3 x each side in line with the hinges / locking points. Fixing may be from the outside or inside depending on the existing aluminium joinery door frame.  
Note: In some situations, the house door may have to be removed from the hinges (knock out hinge pins)
- 5 - Slide the build out frame over the 8 x BCB and position it so that the existing door opens and closes easily.
- 6 - The door must fit evenly within the build out frame, ie. the door should have the same gaps top and bottom, and an even gap on the handle side. Open the door and, working from the inside, use 6g x 12mm pan s/s screws to fix the build out frame to each of the 8 x BCB. Alternatively, pop rivets can be used.
- 7 - Check the door operates correctly, including the handle and lock.
- 8 - Always clean off all fingermarks, leave the site clean and tidy.

<b>Clearguard® Single Door Hinged</b>		<b>SD#</b>
Customer		
Order No	Date	
<b>WO</b> Juralco	<b>SO</b> Juralco	<b>\$</b> Juralco
Select/Enter Dimensions below. Enter details/selections into all boxes. Then scan and send to <a href="mailto:sales@juralco.co.nz">sales@juralco.co.nz</a>		

**This Order Form - Clearguard® Single Door, Hinged only.**

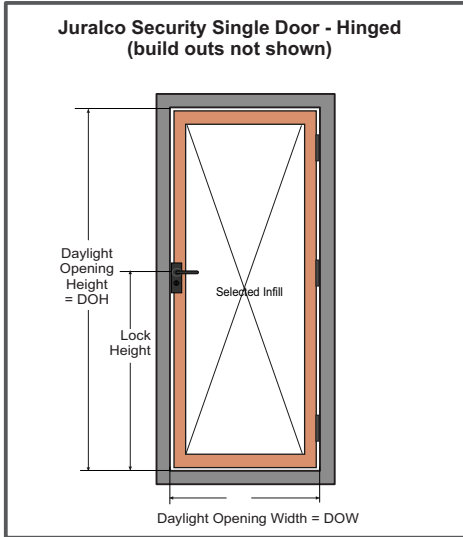

1 Enter Location

Enter Sizes	Dimensions mm	Daylight OH	Daylight OW	Max DOH, DOW - Height 2490mm - Width 1275mm

2 Duralloy  Duralloy Plus  Duratec  OR Select Anodising

Select Finish  Specify PC Colour and Code

Natural   
Bronze

3 Select Buildouts, Options

A	None	<input type="checkbox"/>	Select options						
	B	J7465 Buildout 4 x Sides	<input type="checkbox"/>	JD100 Snib Protector	No	Poly	White	SCC	
			C	J7466 Buildout 4 x Sides	<input type="checkbox"/>	Door Lock Punching	No	Yes	Height
	D	J7467 Adaptor Sides and Top			<input type="checkbox"/>	Hinge JC242 Finish	SS	White	Black
				Heavy Duty Door Closer	No	White	Black		

4 Elegance Lock Options

Lock Finish	White	Black	SCC	Multi Point Kits	High	Low	Pool	Wide Strike Plate	No	Yes
C4 Cylinders	46mm Wafer Random	5 pin Random 64mm Key	5 pin Keyed alike	6 pin Keyed alike	LH Thumb Turn, Random	RH Thumb Turn, Random				

5 Ultimate Lock Options

Lock Finish	Black	SCC	Multi Point Kits	High	Low
-------------	-------	-----	------------------	------	-----

6 Whitco Tasman Mk2 Lock Options

Lock Finish	White	Black	Lock Cylinders	Random Key	Keyed Alike	Extra Wide Strike Plate	No	Yes	Anti Jemmy Kit	No	Yes
-------------	-------	-------	----------------	------------	-------------	-------------------------	----	-----	----------------	----	-----

7 Lockwood 8654 Lock Options

Lock Finish	White	Black	Lock Cylinders	Random Key	Keyed Alike	Extra Wide Strike Plate	No	Yes	Standard 3 Point Kit	No	Yes
-------------	-------	-------	----------------	------------	-------------	-------------------------	----	-----	----------------------	----	-----

8 Remarks

<b>Clearguard® Double Door Hinged</b>		<b>SD#</b>
Customer		
Order No	Date	
<b>WO</b> Juralco	<b>SO</b> Juralco	<b>\$</b> Juralco
Select/Enter Dimensions below. Enter details/selections into all boxes. Then scan and send to <a href="mailto:sales@juralco.co.nz">sales@juralco.co.nz</a>		

**This Order Form - Clearguard® Double Door, Hinged only.**

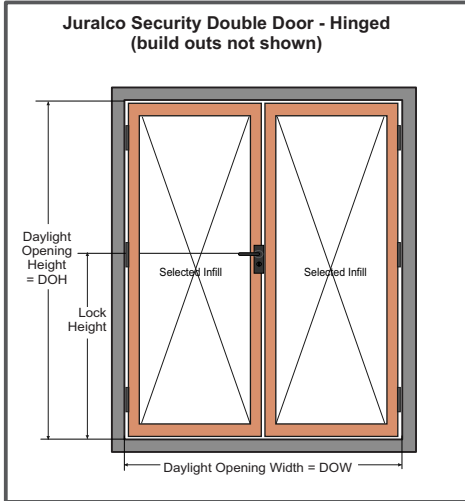

**1** Enter Location

Enter Sizes	Dimensions mm	Daylight OH	Daylight OW	Max DOH, DOW - Height 2490mm - Width 2530mm

**2** Duralloy  Duralloy Plus  Duratec  OR Select Anodising

Select Finish  **Specify PC Colour and Code**

Natural   
Bronze

**3** Select Buildouts, Options

**A** None

**B** **J7465 Buildout 4 x Sides**

**C** **J7466 Buildout 4 x Sides**

Select options

<b>JD100 Snib Protector</b>	No	Poly	White	SCC
	<input type="checkbox"/>	<input type="checkbox"/>	<input type="checkbox"/>	<input type="checkbox"/>
<b>Door Lock Punching</b>	No	Yes	Height	LH or RH Frame
	<input type="checkbox"/>	<input type="checkbox"/>	<input type="checkbox"/>	<input type="checkbox"/>
<b>Hinge JC242 Finish</b>	SS	White	Black	SCC
	<input type="checkbox"/>	<input type="checkbox"/>	<input type="checkbox"/>	<input type="checkbox"/>
<b>Heavy Duty Door Closer</b>	No	White	Black	
	<input type="checkbox"/>	<input type="checkbox"/>	<input type="checkbox"/>	
<b>Narrow Strike Plate</b>	NA	Yes		
	<input type="checkbox"/>	<input type="checkbox"/>		
<b>Whitco Flush Bolts</b>	Singles x 2	Double		
	<input type="checkbox"/>	<input type="checkbox"/>		

**4 Elegance Lock Options**

Lock Finish	White	Black	SCC	Multi Point Kits	High	Low	Pool	Strike Plate	NA	Narrow	Wide
	<input type="checkbox"/>	<input type="checkbox"/>	<input type="checkbox"/>		<input type="checkbox"/>	<input type="checkbox"/>	<input type="checkbox"/>		<input type="checkbox"/>	<input type="checkbox"/>	<input type="checkbox"/>
<b>C4 Cylinders</b>	46mm Wafer Random	5 pin Random 64mm Key	5 pin Keyed alike	5 pin Keyed alike	6 pin Keyed alike	LH Thumb Turn, Random	RH Thumb Turn, Random				

**5 Ultimate Lock Options**

Lock Finish	Black	SCC	Multi Point Kits	High	Low
	<input type="checkbox"/>	<input type="checkbox"/>		<input type="checkbox"/>	<input type="checkbox"/>

**6 Whitco Tasman Mk2 Lock Options**

Lock Finish	White	Black	Lock Cylinders	Random Key	Keyed Alike	Extra Wide Strike Plate	No	Yes	Anti Jemmy Kit	No	Yes
	<input type="checkbox"/>	<input type="checkbox"/>		<input type="checkbox"/>	<input type="checkbox"/>		<input type="checkbox"/>	<input type="checkbox"/>		<input type="checkbox"/>	<input type="checkbox"/>

**7 Lockwood 8654 Lock Options**

Lock Finish	White	Black	Lock Cylinders	Random Key	Keyed Alike	Extra Wide Strike Plate	No	Yes	Standard 3 Point Kit	No	Yes
	<input type="checkbox"/>	<input type="checkbox"/>		<input type="checkbox"/>	<input type="checkbox"/>		<input type="checkbox"/>	<input type="checkbox"/>		<input type="checkbox"/>	<input type="checkbox"/>

**8** Remarks

# Juralco Clearguard® Security Door and Window Systems - Sliding Door Extrusions

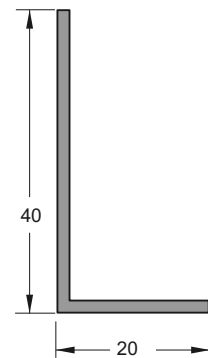
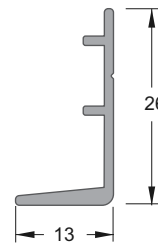
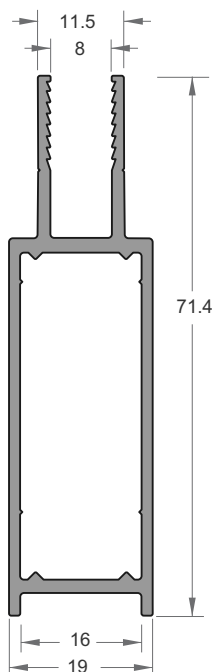
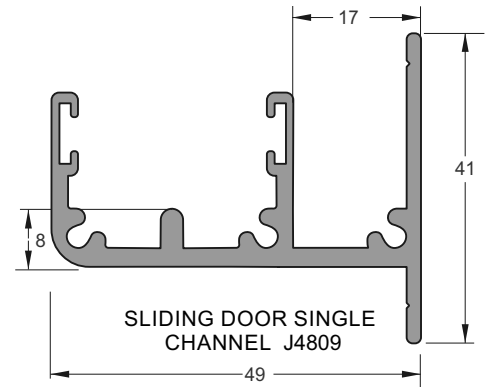
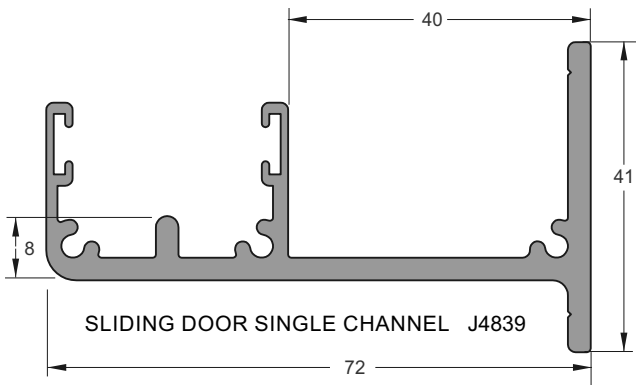
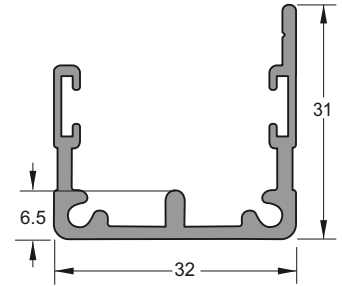
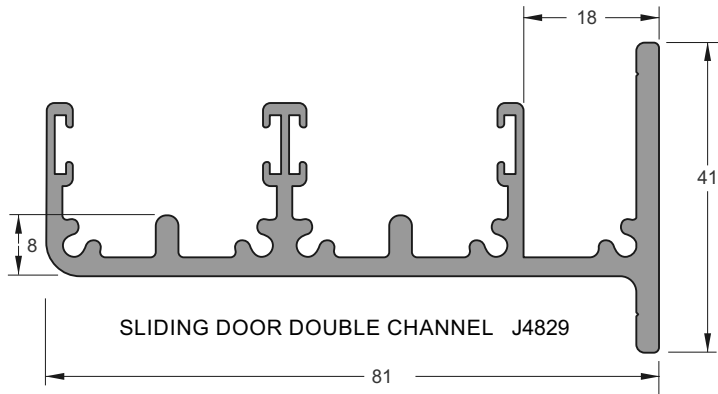
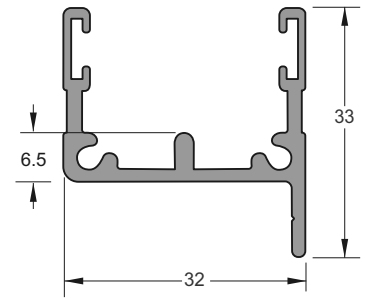
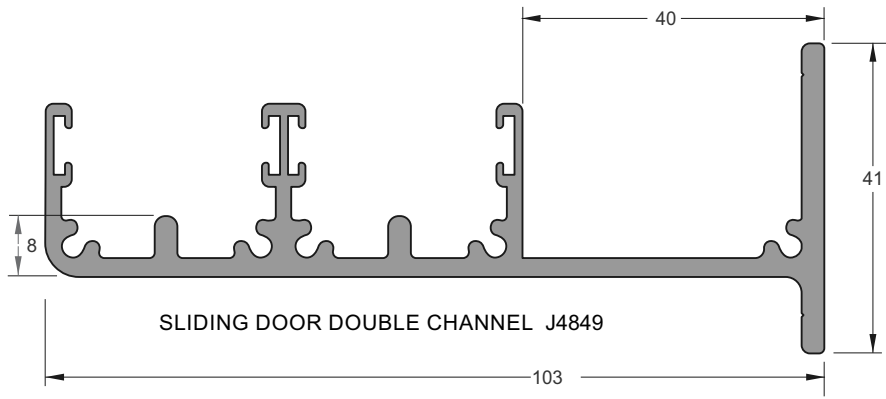

# Juralco Clearguard® Security Door and Window Systems - Sliding Door Components

## Sliding Door Locks SD7Plus + SD14Plus Kit

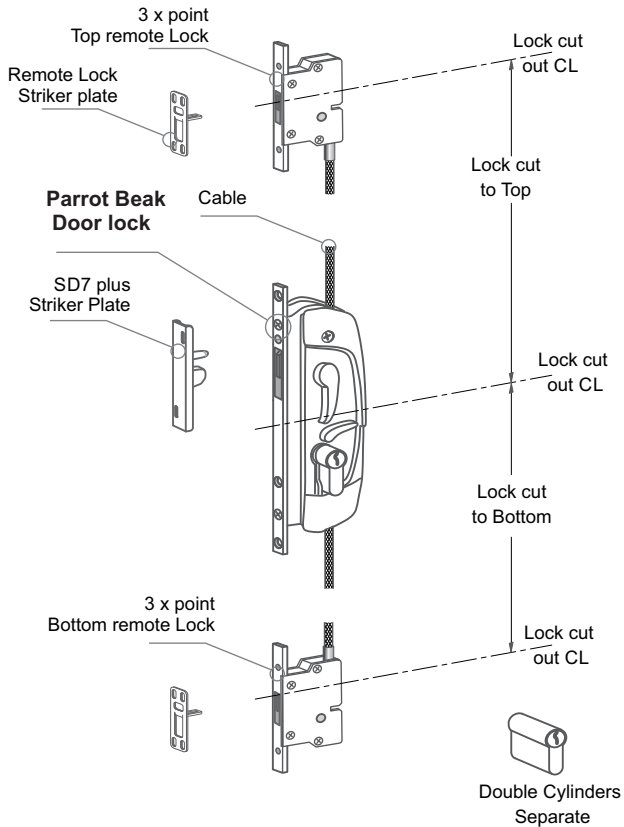

### Sliding Security Doors - Lock Selection

- a - This lock can be used for RH or LH sliding doors .
- b - Standard, Three\_point Lock - including Parrot Beak Door Lock, Cable Drive, Top and Bottom Remote Parrot beak locks
- c - Available in four different CL combinations

Refer Austral Catalog for more information

## Nylon End Stop JC203



## Door Stop JP2306



## Staking Angle, Heavy Duty JC216

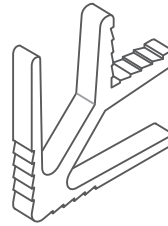

## Kwikfit Roller JC206

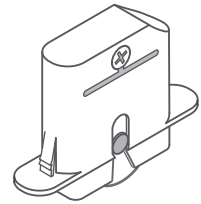

## Patio Bolt JJH22063



## Mohair Strip JC225

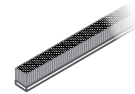

350mt Roll

## Mighty Strong Bolt JJM316B

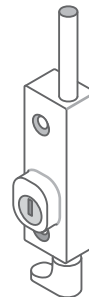

Black  
only

## Patio Bolt JM283



## Security Door Sliding Track End Caps

All attach with, screws  
2 x JVBSCREW/10x6

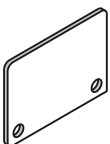

JC458  
For J4558, J4559 Tracks

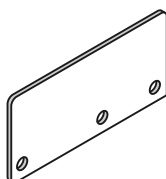

JC809  
For J4809 Track

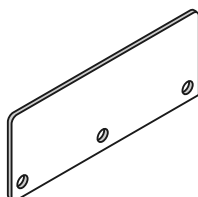

JC839  
For J4839 Track

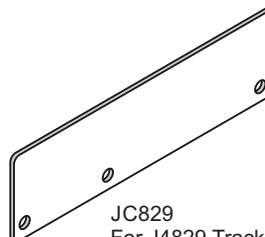

JC829  
For J4829 Track

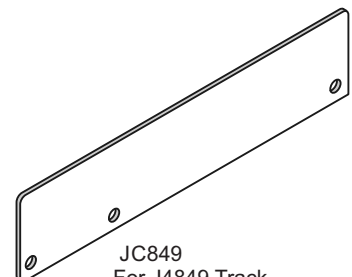

JC849  
For J4849 Track



**JURALCO**

www.juralco.co.nz ph (09) 478 8018

**Juralco Clearguard® Security Door and Window Systems**

Issue 3-23 v1  
Page 24



## Juralco Clearguard® Security Door and Window Systems - Sliding Door, General

### Clearguard Sliding Door Recommendations

- 1 - **Frame** - Heavy duty Door Frame PN J8295
- 2 - **Corner Joints** - JC 216 attach all corners .  
After assembling the frame the door should stay completely rigid.
- 3 - **Security Grille** - Clearguard Perforated Sheet
- 4 - **Lock** - We recommend an Austral SD 7, 3 point lock.
- 5 - **Inter locker** -The two piece interlock system securely locks the back edge of the sliding security door to the existing mullion.  
Select 9715, 9716 or 9717 Male Interlock sections as appropriate for the door/mullion gap.
- 6 - **Fasteners** - High strength, stainless steel rivets to be used for fastening corner stakes and hinges to frame.  
Size and application of rivets must allow no movement between parts. Stainless 8-gauge fixing screws can be used as an alternative.  
The heads of all fasteners must be concealed to restrict access from outside when the door is closed.

For face mounting, on the exterior only.

Note - This configuration can be used to add security to any Door opening. The frame and Clearguard security sheet are lightweight and suitable for all environments.

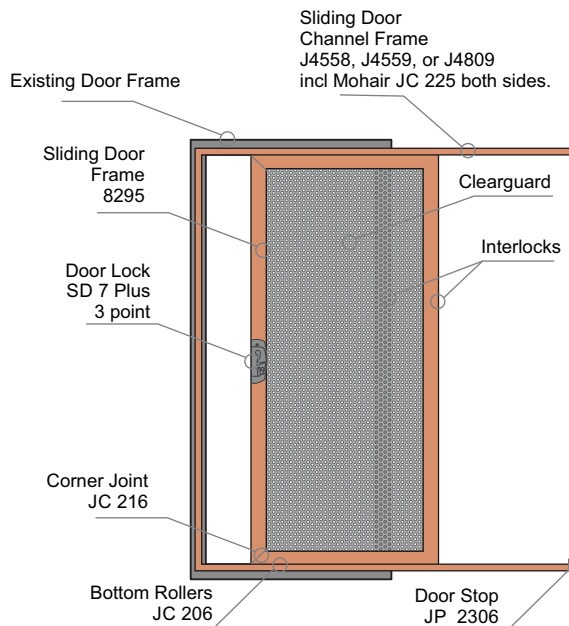

### Clearguard Sliding Door Measuring

#### Check list for measuring up a Security Door

- 1 - **Select Sliding Door Channel Frame (SDCF)**  
Choose 4809 or 4559 32mm Channel for a normal Door, or 4809 49mm Channel if an offset is needed or opening a sash window on existing slider.
- 2 - **Fixing Method** - Determine method of fixing SDCF to face of existing joinery. Is there sufficient fixing or is a box section or angle pocket required.
- 3 - **Frame** - Will SDCF be 4 sides or 3 sides only (ie nonlocking vertical side left open)
- 4 - **SDFC Setout** - Determine actual fixing position of SDCF by using extrusion offcut, locate, mark and measure for overall height and width of SDCF.
- 5 - **Sliding Door Panel (SDP) Height Setout**  
When installing the door, use the height adjustment to locate the SDP to the SDCF.
- 6 - **Sliding Door Panel (SDP) Width Setout**  
To determine width of SDP.  
Care must be taken when measuring to determine:
  - (i) Which Interlock to use on existing aluminium joinery mullion, either 9716, 9717 or 9718.
  - (ii) Ensure that the Interlock chosen locates securely into the 9719 Female Interlock when the SDP is in the locked position.  
This is the critical factor in determining the actual width of the SDP
  - (iii) Determine points (i) & (ii) & using offcut extrusion mark & measure width accordingly.
- 7 - **Check** around doorway to see there are no protruding fuse boxes or hanging lights to stop security door from fully opening.
- 8 - **Check** to see that there are no door knockers or door bells that may require relocating before security door could be installed.
- 9 - **Check** colour finish of Supascreen door. .

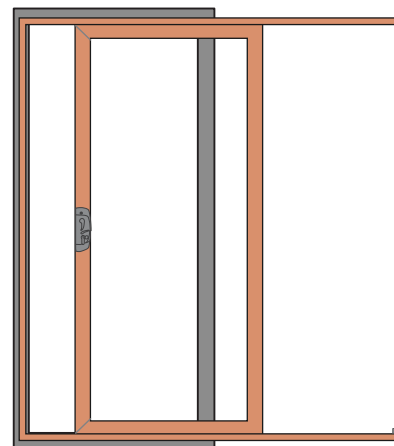

# Juralco Clearguard® Security Door and Window Systems - Sliding Door, Cutting

Clearguard Single Sliding Door

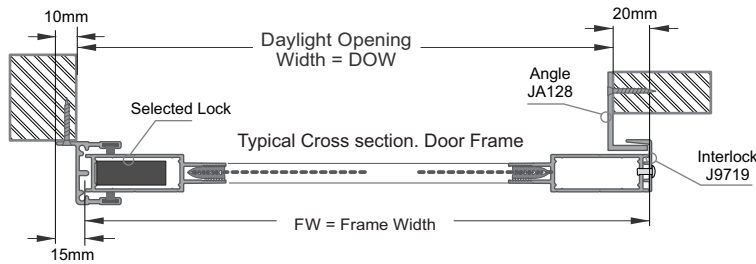
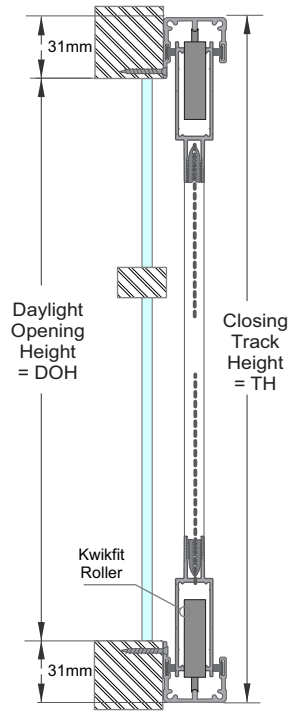
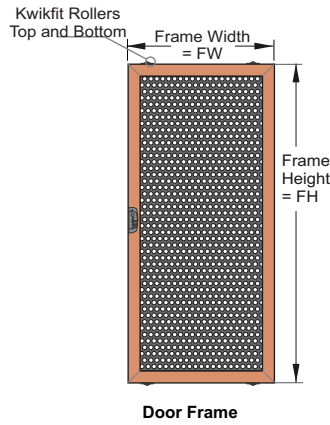
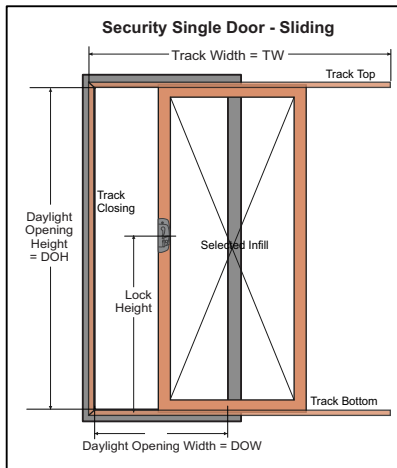
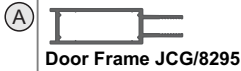

## CLEARGUARD SINGLE SLIDING DOOR Tracks J4558/J4559

## Components, always needed

	HEIGHTS, WIDTHS	Part	Cutting Calc	No
1	Closing Track Height TH	J4558	$(DOH + 62) = TH$	1
2	Woolpile Height	JC225	TH	2
3	Door Frame Height FH	JCGS/8295	$(DOH + 37) = FH$	2
1	Track Width TW	J4559	Enter Width = TW	2
2	Woolpile Width	JC225	TW	4
3	Door Frame Width FW	JCGS/8295	$(DOW + 5) = FW$	2

	Description	Part No	No
1	Kwikfit Roller	JC206	4
2	Corner Stake HD	JC216	4
3	Track End Cap	JC458	2
4	Track End Stop	JC203	1

1	Clearguard Panel Height	JCG/AL	FH - 110	1
2	Co-extruded Plug Height	JCG Tape	FH - 150	2
3	Door Interlock Height	J9719	FH	2
4	Wall Interlock Angle Height	JA128	FH	2
1	Clearguard Panel Width	JCG/AL	FW - 110	1
2	Co-extruded Plug Width	JCG Tape	FW - 150	2

### + Security Sliding Door Locks

Choice of Austral Murray SD7, SD8 or Whitco Liechardt.

Associated Cylinders, Multipoint Kits and Black, White, SCC finishes for SD7, SD8  
All as per Feb 2020 Price Book

**Cutting calculations** - These are a guide only, confirm before cutting  
Strongly Recommended - Allow +30mm per cut to allow for Trimming/Mitre cuts and on site adjustment

# Juralco Clearguard® Security Door and Window Systems - Sliding Door, Cutting

Clearguard Single Sliding Door

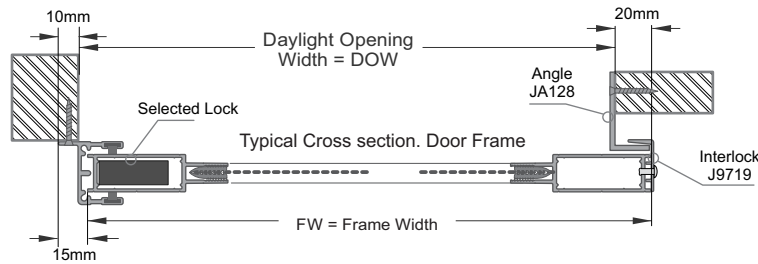
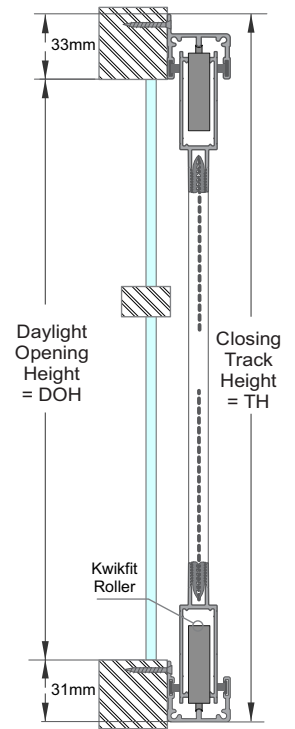
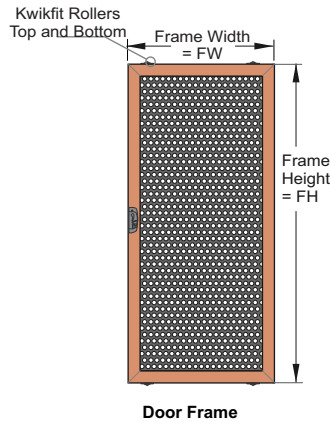
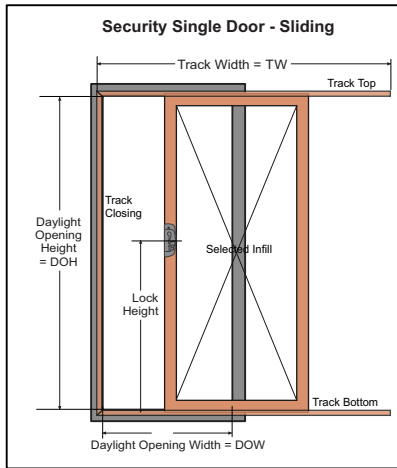
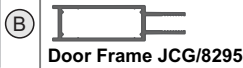

## CLEARGUARD SINGLE SLIDING DOOR Tracks J4558/J4559

## Components, always needed

	HEIGHTS, WIDTHS	Part	Cutting Calc	No
1	Closing Track Height TH	J4558	$(DOH + 64) = TH$	1
2	Woolpile Height	JC225	TH	2
3	Door Frame Height FH	JCGS/8295	$(DOH + 37) = FH$	2
1	Track Width	J4559	Enter Width = TW	2
2	Woolpile Width	JC225	TW	4
3	Door Frame Width FW	JCGS/8295	$(DOW + 5) = FW$	2

	Description	Part No	No
1	Kwikfit Roller	JC206	4
2	Corner Stake HD	JC216	4
3	Track End Cap	JC458	2
4	Track End Stop	JC203	1

1	Clearguard Panel Height	JCG/AL...	FH - 111	1
2	Co-extruded Plug Height	JCG Tape..	FH - 149	2
3	Door Interlock Height	J9719	FH	2
4	Wall Interlock Angle Height	JA128	FH	2
1	Clearguard Panel Width	JCG/AL..	FW - 111	1
2	Co-extruded Plug Width	JCG Tape...	FW - 149	2

### + Security Sliding Door Locks

Choice of Austral Murray SD7, SD8 or Whitco Liechardt.  
Associated Cylinders, Multipoint Kits and Black, White, SCC finishes for SD7, SD8  
All as per Feb 2020 Price Book

Cutting calculations - These are a guide only, confirm before cutting  
Strongly Recommended - Allow +30mm per cut to allow for Trimming/Mitre cuts and on site adjustment

# Juralco Clearguard® Security Door and Window Systems - Sliding Door, Cutting

Clearguard Single Sliding Door

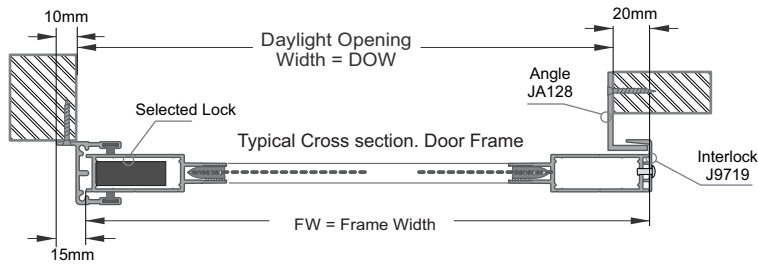
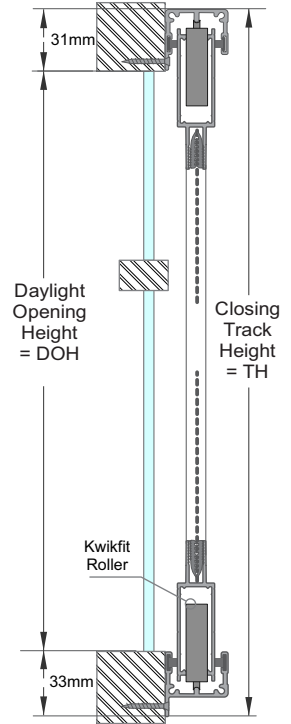
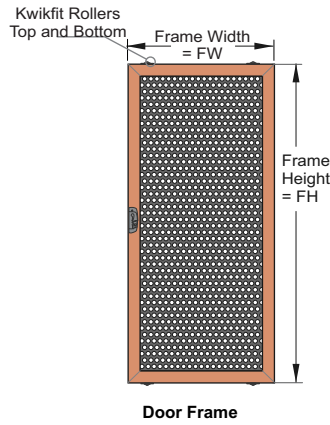
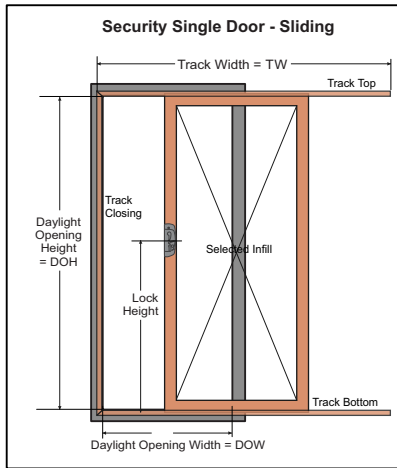
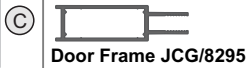

## CLEARGUARD SINGLE SLIDING DOOR Tracks J4558/J4559

## Components, always needed

	HEIGHTS, WIDTHS	Part	Cutting Calc	No
1	Closing Track Height TH	J4558	$(DOH + 64) = TH$	1
2	Woolpile Height	JC225	TH	2
3	Door Frame Height FH	JCGS/8295	$(DOH + 37) = FH$	2
1	Track Width TW	J4558, J4559	Enter Width = TW	1ea
3	Woolpile Width	JC225	TW	4
3	Door Frame Width FW	JCGS/8295	$(DOW + 5) = FW$	2

	Description	Part No	No
1	Kwikfit Roller	JC206	4
2	Corner Stake HD	JC216	4
3	Track End Cap	JC458	2
4	Track End Stop	JC203	1

1	Clearguard Panel Height	JCG/AL...	FH - 111	1
2	Co-extruded Plug Height	JCG Tape...	FH - 149	2
3	Door Interlock	J9719	FH	2
4	Wall Interlock Angle	JA128	FH	2
1	Clearguard Panel Width	JCG/AL..	FW - 111	1
2	Co-extruded Plug Width	JCG Tape...	FW - 149	2

### + Security Sliding Door Locks

Choice of Austral Murray SD7, SD8 or Whitco Liechardt.

Associated Cylinders, Multipoint Kits and Black, White, SCC finishes for SD7, SD8  
All as per Feb 2020 Price Book

**Cutting calculations** - These are a guide only, confirm before cutting  
Strongly Recommended - Allow +30mm per cut to allow for Trimming/Mitre cuts and on site adjustment

# Juralco Clearguard® Security Door and Window Systems - Sliding Door, Cutting

Clearguard Single Sliding Door

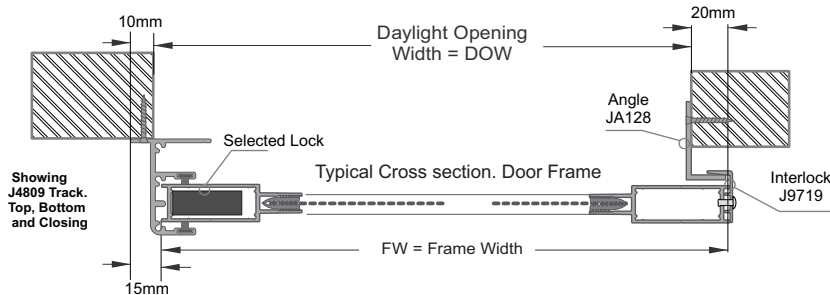
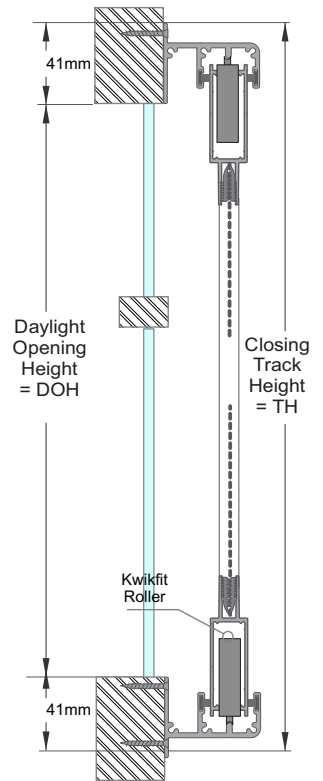
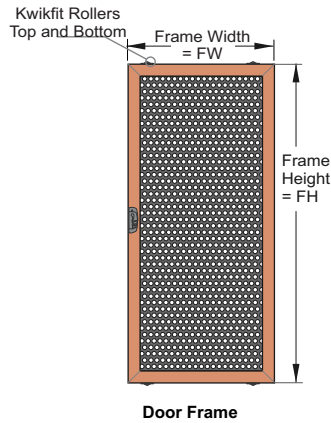
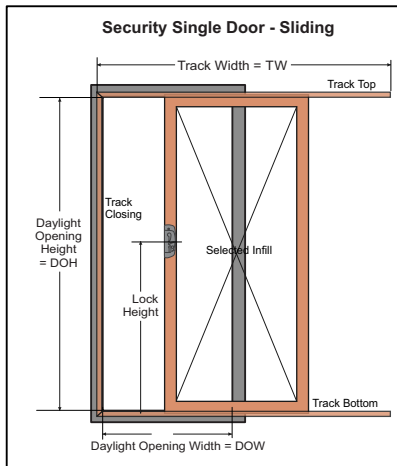
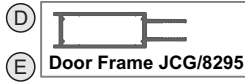

## CLEARGUARD SINGLE SLIDING DOOR Tracks J4809 or J4839

## Components, always needed

	HEIGHTS, WIDTHS	Part	Cutting Calc	No
1	Closing Track Height TH	J4809 or J4839	$(DOH + 82) = TH$	1
2	Woolpile Height	JC225	TH	2
3	Door Frame Height FH	JCG/8295	$(DOH + 37) = FH$	2
1	Track Width TW	J4809 or J4839	Enter Width = TW	2
2	Woolpile Width	JC225	TW	4
3	Door Frame Width FW	JCG/8295	$(DOW + 5) = FW$	2

	Description	Part No	No
1	Kwikfit Roller	JC206	4
2	Corner Stake HD	JC216	4
3	Track End Cap	JC458	2
4	Track End Stop	JC203	1

1	Clearguard Panel Height	JCG/AL...	FH - 111	1
2	Co-extruded Plug Height	JCG Tape..	FH - 149	2
3	Door Interlock Height	J9719	FH	2
4	Wall Interlock Angle Height	JA128	FH	2
1	Clearguard Panel Width	JCG/AL..	FW - 111	1
2	Co-extruded Plug Width	JCG Tape...	FW - 149	2

### + Security Sliding Door Locks

Choice of Austral Murray SD7, SD8 or Whitco Liechart.

Associated Cylinders, Multipoint Kits and Black, White, SCC finishes for SD7, SD8 All as per Feb 2020 Price Book

**Cutting calculations** - These are a guide only, confirm before cutting  
Strongly Recommended - Allow +30mm per cut to allow for Trimming/Mitre cuts and on site adjustment

# Juralco Clearguard® Security Door and Window Systems - Sliding Door, Cutting

Clearguard Double Stacking Sliding Door

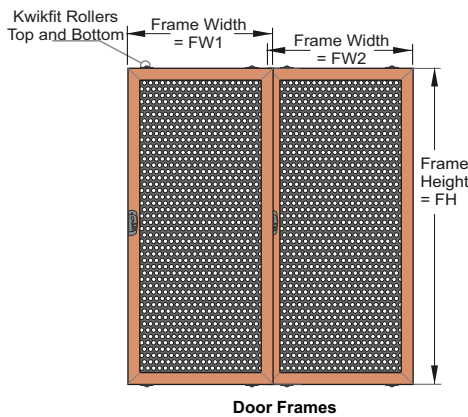
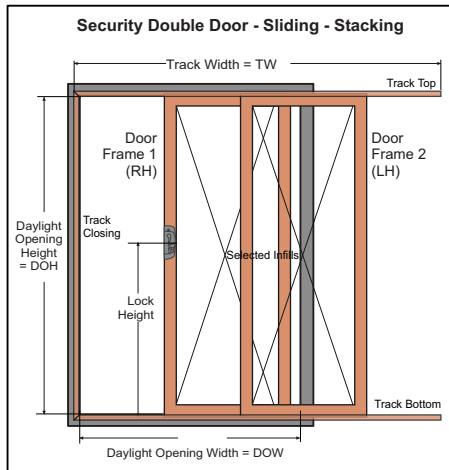

Door Widths can be Equal or Unequal

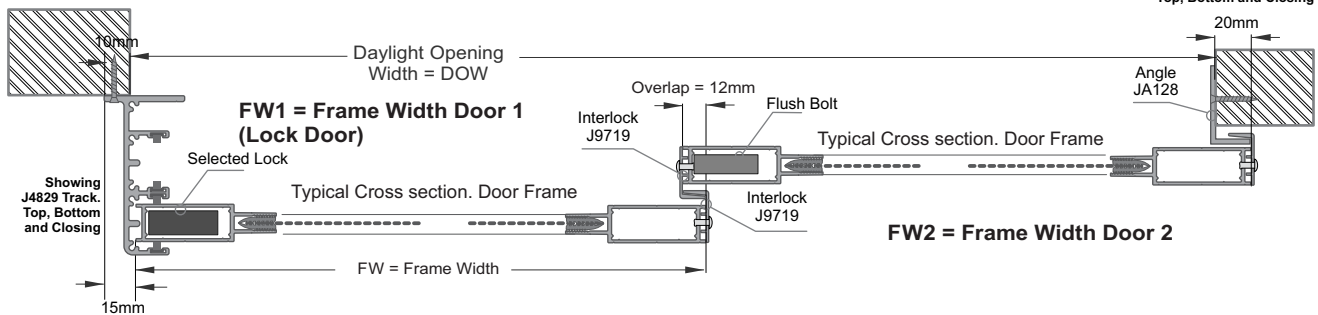
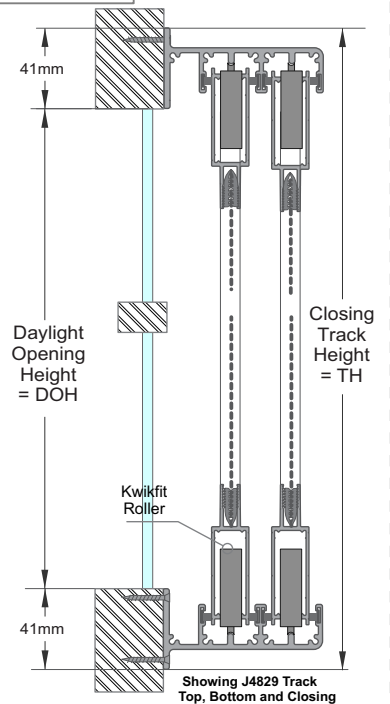

## CLEARGUARD DOUBLE/STACKING SLIDING DOOR

Tracks J4829 or J4849

Door Widths can be Equal or Unequal

	HEIGHTS, WIDTHS	Part	Cutting Calc	No
1	Closing Track Height TH	J4829 or J4849	$(DOH + 82) = TH$	1
2	Woolpile Height	JC225	TH	2
3	Door Frame Height FH	JCG/8295	$(DOH + 37) = FH$	4
1	Track Width TW	J4829 or J4849	Enter Width = TW	2
2	Woolpile Width	JC225	TW	8
3	Door Frame Width <b>EQUAL</b>		$(DOW + 27)/2 = FW$	4
4	Door Frame Width <b>Unequal</b> FW1	JCG/8295	Enter Width =FW1	2
5	Door Frame Width <b>Unequal</b> FW2		$(DOW+17-FW1) =FW2$	2

1	Clearguard Panel Height	JCG/AL...	FH - 111	2
2	Co-extruded Plug Height	JCG Tape..	FH - 149	4
3	Door Interlock Height	J9719	FH	3
4	Wall Interlock Angle Height	JA128	FH	1
1	Clearguard Panel Width	JCG/AL..	FW(1,2) - 111	2
2	Co-extruded Plug Width	JCG Tape...	FW(1,2) - 149	4

## Components, always needed

	Description	Part	No
1	Kwikfit Rollers	JC206	8
2	Corner Stake HD	JC216	8
3	Track End Caps	JC829 or JC849	2
4	Track End Stop	JC203	1
Select either Flushbolts			
5	Whitco Single Flushbolt	JJH203817	2
6	Austral Double Flushbolt, with Rods	JJMFlushbolt/BLK	1

## + Security Sliding Door Locks

Choice of Austral Murray SD7, SD8 or Whitco Liechart.

Associated Cylinders, Multipoint Kits and Black, White, SCC finishes for SD7, SD8 All as per Feb 2020 Price Book

Cutting calculations - These are a guide only, confirm before cutting  
Strongly Recommended - Allow +30mm per cut to allow for Trimming/Mitre cuts and on site adjustment

# Juralco Clearguard® Security Door and Window Systems - Sliding Door, Cutting

Clearguard Double  
Centre Join Sliding Door

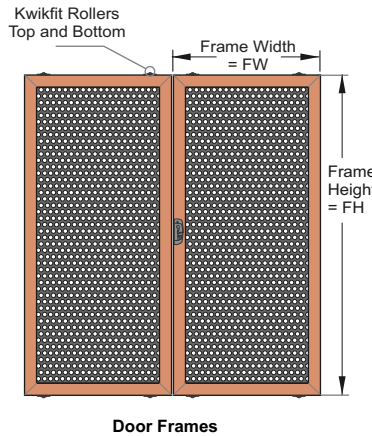
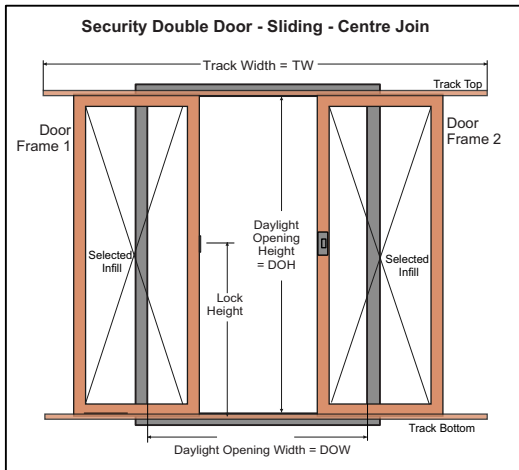

Door Widths only Equal

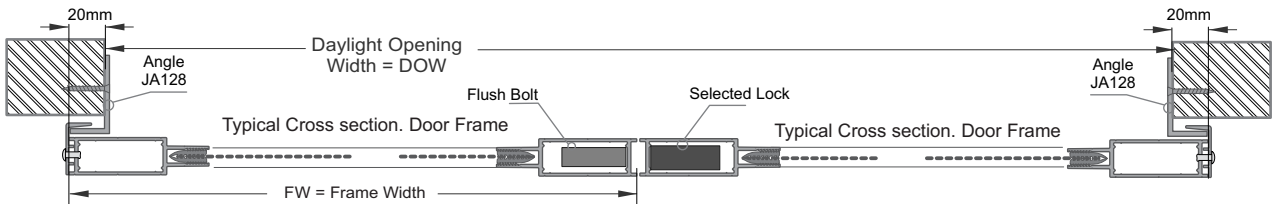
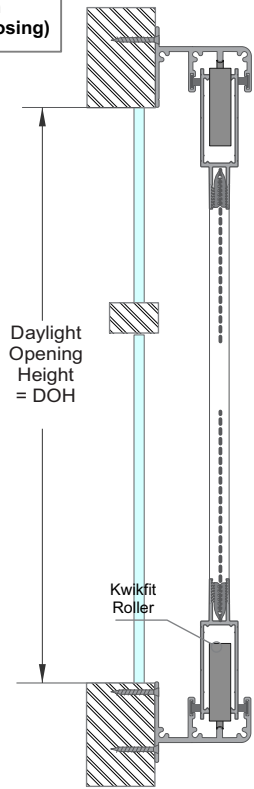

## CLEARGUARD DOUBLE/CENTRE JOIN SLIDING DOOR Tracks J4829 or J4849

Door Widths only Equal

	HEIGHTS, WIDTHS	Part	Cutting Calc	No
1	Door Frame Height FH	JCG/8295	$(DOH + 37) = FH$	4
1	Track Width TW	J4829 or J4849	Enter Width = TW	2
2	Woolpile Width	JC225	TW	4
3	Door Frame Width <b>EQUAL</b> FW	JCG/8295	$(DOW + 40)/2 = FW$	4

1	Clearguard Panel Height	JCG/AL	FH - 111	2
2	Co-extruded Plug Height	JCG Tape	FH - 149	4
3	Door Interlock Height	J9719	FH	2
4	Wall Interlock Angle Height	JA128	FH	2
1	Clearguard Panel Width	JCG/AL	FW - 111	2
2	Co-extruded Plug Width	JCG Tape	FW - 149	4

Cutting calculations - These are a guide only, confirm before cutting  
Strongly Recommended - Allow +30mm per cut to allow for Trimming/Mitre cuts and on site adjustment

## Components, always needed

	Description	Part	No
1	Kwikfit Rollers	JC206	8
2	Corner Stake HD	JC216	8
3	Track End Caps	JC809 or JC839	2
4	Track End Stop	JC203	1
Select either Flushbolts			
5	Whitco Single Flushbolt	JJH203817	2
6	Austral Double Flushbolt, with Rods	JJMFlushbolt/BLK	1

## + Security Sliding Door Locks

Choice of Austral Murray SD7, SD8 or Whitco Liechardt.  
Associated Cylinders, Multipoint Kits and Black, White, SCC finishes for SD7, SD8  
All as per Feb 2020 Price Book

# Juralco Clearguard® Security Door and Window Systems - Sliding Door, Machining

## Clearguard Sliding Door Machining, Assembly

**SD 7 is the Centre Lock  
SD 14 Plus are the Top  
and Bottom Locks**

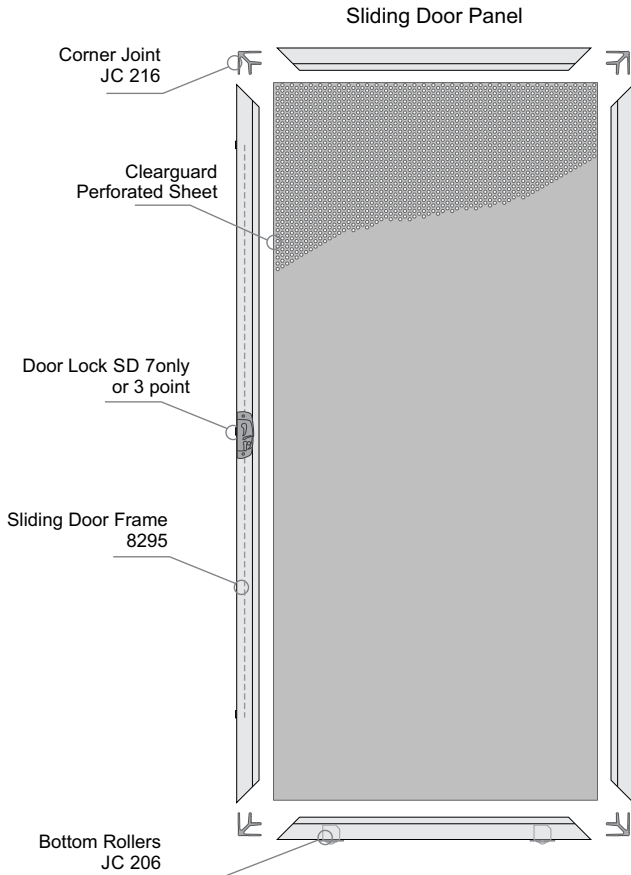

**Sliding Clearguard Security Doors - Lock Selection**  
Centre only or Three point Lock, Cable Drive.

## SD 7, SD 14 Plus 3 Point Lock and Roller Machining

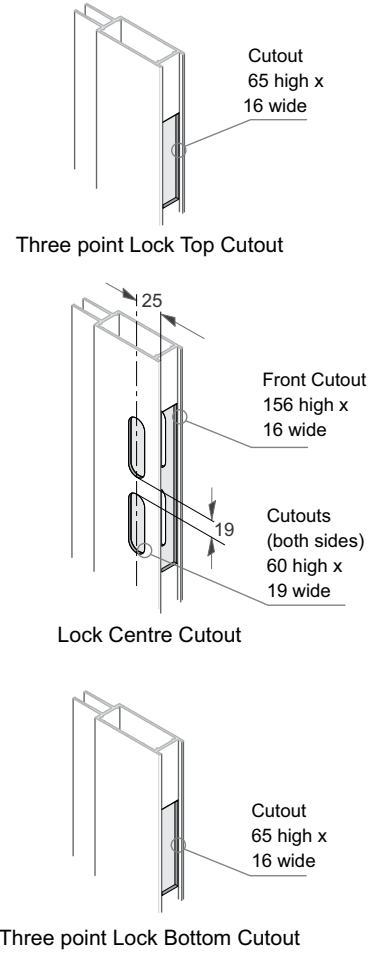

## Sliding Door Panel Corners

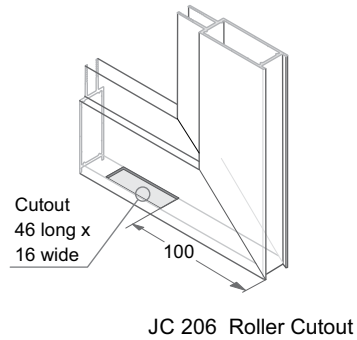
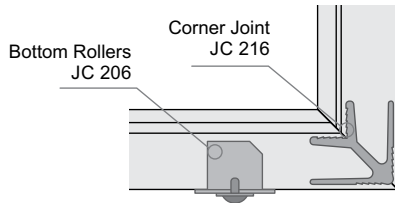

## SD14Plus Door Frame Machining Setouts

SD 7, SD 14 Plus	A dim	B dim
Machining setouts	to Top	to Bottom
High centre Lock	546	961
Low Centre Lock	961	546
Pool CentreLock	375	961
Set out tolerances all +/- 3mm		

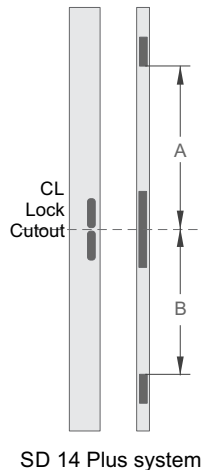

## SD Channel Corner Attach

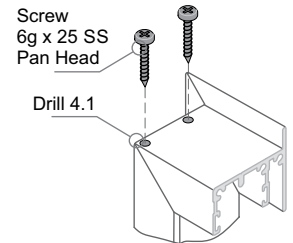
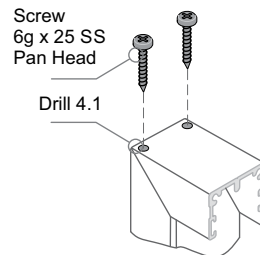



## Clearguard Sliding Door Installation

- 1 - Check the extrusions supplied are the correct ones for this application, ie. they fit around windows and take account of any restricted clearances around the door frame.
- 2 - Screw the vertical jamb extrusion into position so that the top and bottom tracks can be easily and properly fixed into position.
  - a- The bottom track is usually "top-fixed" extrusion.
  - b - The side and top tracks are usually "sub-fixed" extrusion.
  - c - The miters should be checked to ensure any excess 'wings' are cut off before installation
- 3 - Check the door is the correct size, ie. the door doesn't interfere with any adjacent opening windows.
- 4 - Screw the bottom track into place, making sure it is as close as possible to 90deg with the vertical closing jamb, and running in a straight line without sags or bumps.
- 5 - Place the door onto the bottom track and level up with the closing jamb using the adjustable door rollers.
- 6 - Screw the top track into position, making sure the extrusion sits underneath any opening windows.
- 7 - Mark the door latch position on the closing jamb.
- 8 - Using 2 of 10g x 12mm Pan S/S screws, screw the door latch packer to the closing jamb
- 9 - Screw the door latch to the door latch packer using 2 of 10g x 12mm Pan S/S screws.  
fit the brush strip to the back of the door or to the mullion (prefer the mullion if there is an opening window adjacent)
- 10 - Fit Interlock angles to backs of Door and Mullions.
- 11 - Test Doors for smoothness + shutting/locking and full retraction to stops.
- 12 - Always clean off all fingermarks, leave the site clean and tidy.

<b>Clearguard® Single Door Sliding</b>		<b>SD#</b>
Customer		
Order No	Date	
<b>WO</b> Juralco	<b>SO</b> Juralco	<b>\$</b> Juralco
Select/Enter Dimensions below. Enter details/selections into all boxes. Then scan and send to <a href="mailto:sales@juralco.co.nz">sales@juralco.co.nz</a>		

**This Order Form - Clearguard® Single Door, Sliding only.**

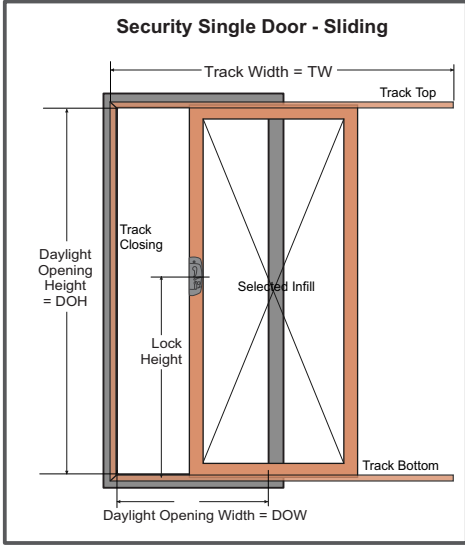

**1** Enter Location

Enter Sizes	Dimensions mm	Daylight OH	Daylight OW	Track Width (TW)	Max DOH, DOW - Height 2490mm - Width 1275mm

**2** Duralloy  Duralloy Plus  Duratec  OR Select Anodising

Select Finish  **Specify PC Colour and Code**

Natural   
Bronze

**3** Select Track Layouts, Types

		Select options					
A	J4558 Track Closing	J4559 Track Top and Bottom	Door Lock Punching	No	Yes	Height	LH or RH Closing
B	J4558 Track Top and Closing	J4559 Track Bottom					
C	J4558 Track Bottom and Closing	J4559 Track Top					
D	J4809 Track Top, Bottom and Closing						
E	J4839 Track Top, Bottom and Closing						

**4** Austral Murray SD7 or SD8 Lock Options

Lock Type	SD7	SD8	Lock Finish	White	Black	SCC	Multi Point Kits	High	Low
<b>C4 Cylinders</b>	46mm Wafer Random	5 pin Random 64mm Key	5 pin Keyed alike	6 pin Keyed alike	LH Thumb Turn, Random	RH Thumb Turn, Random			

**5** Whitco Liechardt Lock Options (Black only)

Whitco Cylinders	Random Key	Keyed Alike	LH Thumb Turn, Random	RH Thumb Turn, Random	Multi Point (Black)	No	Yes

**6** Remarks

<b>Clearguard® Double Door Sliding/Stacking</b>		<b>SD#</b>
Customer		
Order No	Date	
<b>WO</b> Juralco	<b>SO</b> Juralco	<b>\$</b> Juralco
Select/Enter Dimensions below. Enter details/selections into all boxes. Then scan and send to <a href="mailto:sales@juralco.co.nz">sales@juralco.co.nz</a>		

**This Order Form - Clearguard® Double Door/Stacking, Sliding only.**

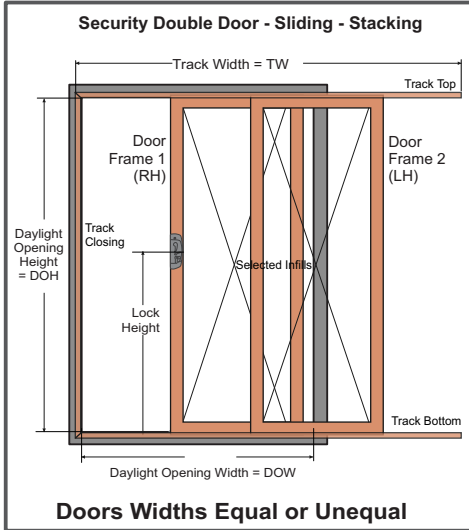

**1** Enter Location

Enter Sizes	Dimensions mm	Daylight OH	Daylight OW	Track Width (TW)	Max DOH, DOW - Height 2490mm - Width 2530mm

**2** Duralloy  Duralloy Plus  Duratec  OR Select Anodising

Select Finish  Specify PC Colour and Code

Natural   
Bronze

**3** Select Track Layouts, Options Select options

<b>A</b> J4829 Track Top, Bottom and Closing <input type="checkbox"/>	<table border="1" style="width:100%; border-collapse: collapse;"> <tr> <th>Door Lock Punching</th> <th>No</th> <th>Yes</th> <th>Height</th> <th>LH or RH Closing</th> </tr> <tr> <td> </td> <td> </td> <td> </td> <td> </td> <td> </td> </tr> </table>	Door Lock Punching	No	Yes	Height	LH or RH Closing					
Door Lock Punching	No	Yes	Height	LH or RH Closing							
<b>B</b> J4849 Track Top, Bottom and Closing <input type="checkbox"/>	<table border="1" style="width:100%; border-collapse: collapse;"> <tr> <th>Whitco Flush Bolts</th> <th>Singles x 2</th> <th>Double</th> </tr> <tr> <td> </td> <td> </td> <td> </td> </tr> </table>	Whitco Flush Bolts	Singles x 2	Double							
Whitco Flush Bolts	Singles x 2	Double									

**4** Door Widths Equal or Unequal  If Unequal Enter Width  Door Frame 1 (LH)

If Unequal Enter Width  Door Frame 2 (RH)

Note: Door Frame Widths 1280mm max

**5** Austral Murray SD7 or SD8 Lock Options

Lock Type	SD7	SD8	Lock Finish	White	Black	SCC	Multi Point Kits	High	Low
C4 Cylinders	46mm Wafer Random	5 pin Random 64mm Key	5 pin Keyed alike	6 pin Keyed alike	LH Thumb Turn, Random	RH Thumb Turn, Random			

**6** Whitco Liechardt Lock Options (Black only)

Whitco Cylinders	Random Key	Keyed Alike	LH Thumb Turn, Random	RH Thumb Turn, Random	Multi Point (Black)	No	Yes

**7** Remarks

<b>Clearguard® Double Door Sliding/Centre Join</b>		<b>SD#</b>
Customer		
Order No	Date	
<b>WO</b> Juralco	<b>SO</b> Juralco	<b>\$</b> Juralco
Select/Enter Dimensions below. Enter details/selections into all boxes. Then scan and send to <a href="mailto:sales@juralco.co.nz">sales@juralco.co.nz</a>		

**This Order Form - Clearguard® Double Door/Centre Join, Sliding only.**

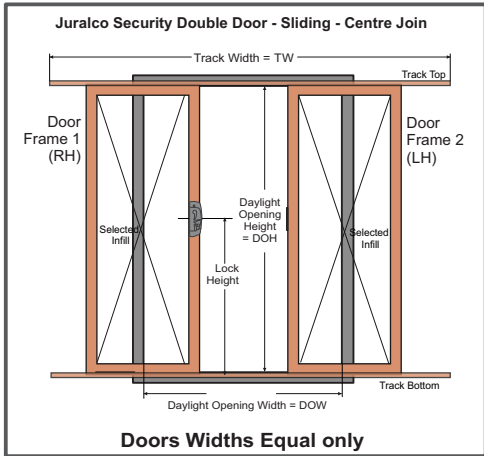

**1** Enter Location

Enter Sizes	Dimensions mm	Daylight OH	Daylight OW	Track Width (TW)	Max DOH, DOW - Height 2490mm - Width 2530mm

**2** Duralloy  Duralloy Plus  Duratec  OR Select Anodising

Select Finish  Specify PC Colour and Code

Natural   
Bronze

**3** Select Track Layouts, Options      Select options

<b>A</b> J4809 Track. Top, Bottom and Closing <input type="checkbox"/>	<table border="1" style="width: 100%; border-collapse: collapse;"> <tr> <th style="width: 15%;">Door Lock Punching</th> <th style="width: 10%;">No</th> <th style="width: 10%;">Yes</th> <th style="width: 10%;">Height</th> <th style="width: 55%;">LH or RH Frame</th> </tr> <tr> <td></td> <td></td> <td></td> <td></td> <td></td> </tr> </table>	Door Lock Punching	No	Yes	Height	LH or RH Frame					
Door Lock Punching	No	Yes	Height	LH or RH Frame							
<b>B</b> J4839 Track. Top, Bottom and Closing <input type="checkbox"/>	<table border="1" style="width: 100%; border-collapse: collapse;"> <tr> <th style="width: 40%;">Whitco Flush Bolts</th> <th style="width: 20%;">Singles x 2</th> <th style="width: 40%;">Double</th> </tr> <tr> <td></td> <td></td> <td></td> </tr> </table>	Whitco Flush Bolts	Singles x 2	Double							
Whitco Flush Bolts	Singles x 2	Double									

**5** Austral Murray SD7 or SD8 Lock Options

Lock Type	SD7	SD8	Lock Finish	White	Black	SCC	Multi Point Kits	High	Low
<b>C4 Cylinders</b>	46mm Wafer Random	5 pin Random 64mm Key	5 pin Keyed alike	5 pin Keyed alike	6 pin Keyed alike	LH Thumb Turn, Random	RH Thumb Turn, Random		

**6** Whitco Liechardt Lock Options (Black only)

Whitco Cylinders	Random Key	Keyed Alike	LH Thumb Turn, Random	RH Thumb Turn, Random	Multi Point (Black)	No	Yes

**7** Remarks

# Juralco Clearguard® Security Door and Window Systems - Mesh Fitting

## General, Tools for Perf Panel Installation

### Pre Assembly

- 1- Clean up work bench, make sure work top absolutely clean. Inspect extrusions are free from damage and straight.
- 2 - Read Job Sheet carefully and understand **All instructions**. All measurements, number required, lock arrangements, lock side, colour, installation type, mounting, LH or RH, all prepunching required.
- 3 - Collect and check all components and extrusions needed for this job. Check all tools needed are clean and in good working order.
  - Suggested Tool and Equipment list.
  - Assembly Press, Generation Mk2 and bench
  - Dead hammer, Thor 44mm face
  - Hand Shears, Makita JS 1600 electric, or Guillotene
  - Tin snips
  - PVC- HD block 25 x 100 x 150
  - Electric/ Air drill gun and Electric screwdriver.
  - Tape Measure, Square, Screwdrivers, White marking pen or engineers chalk.
  - Electric Mitre saw with aluminium sharpened saw, set to cut exact 45 deg.
  - Corner stake locking punch
  - Punch or router for Locks and Rollers.

Window Frame  
7811

## Cutting for Perf Panel Installation

### Cutting

- 1- Cut Frame to measurements at exact 45 deg miters.
- 2 - Cut PVC plugs to length, straight cuts.
- 3 - Cut mid rails (optional), straight cuts.
- 4 - Cut perf sheet, square on all four sides.
- 5 - After cutting the offsets should be as drawn.

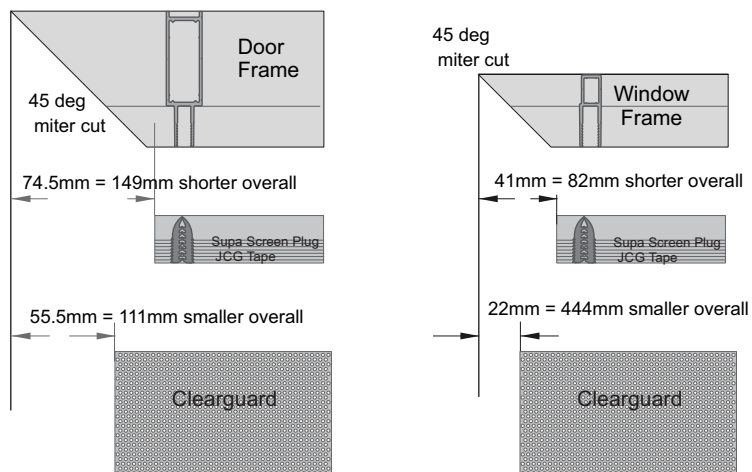

**Note: IT IS VERY IMPORTANT THAT THE SHEET IS CUT EXACTLY SQUARE AND STRAIGHT**

## Juralco Clearguard® Security Door and Window Systems - Mesh Fitting

### Assembly Frame and Perf Sheet

Note - The assembly procedure described applies equally to doors and windows.

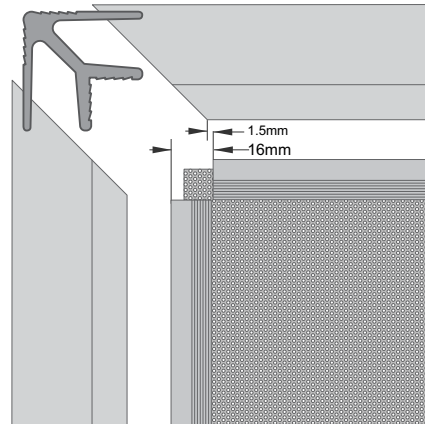
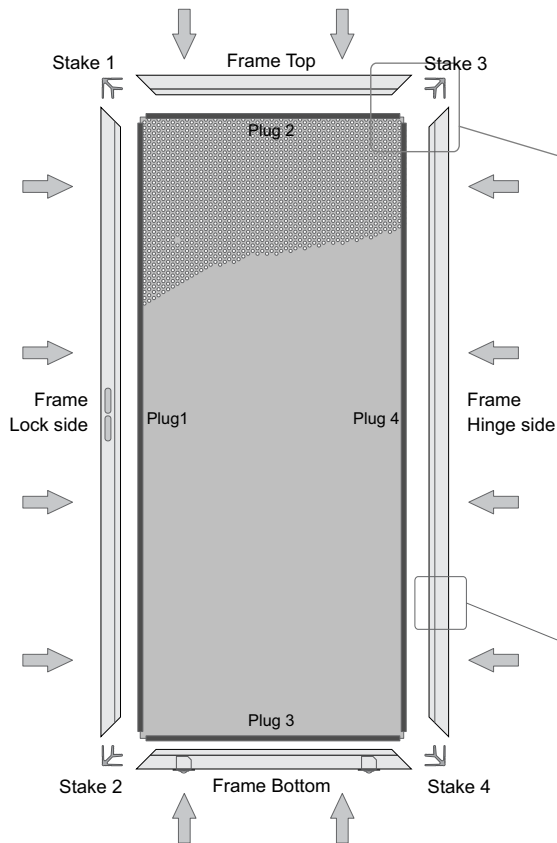

Frame Corner showing Plug and Sheet offsets



Frame showing Plug and Sheet - partially engaged

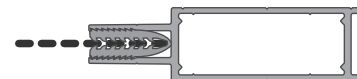

Frame showing Plug and Sheet - fully engaged

Note - Sheet must be at bottom of plug

**Note: BEFORE ANY ASSEMBLY CHECK THAT THE SHEET IS EXACTLY SQUARE AND CUT WITH STRAIGHT SIDES**

### Assembly

- 1 - Lay Sheet, plugs and extrusions on work bench. Make sure there is no metallic debris from cutting, filing operations/sweep clean. Take great care not to scratch any surface.
- 2 - Check all measurements and diagonals for squareness. Recheck the frame, sheet and plug dimensions
  - the plugs should be the sheet length/width minus 32mm
- 3 - Assembly can be carried out with a Thor dead blow hammer (do not use a wooden mallet) and plastic/Teflon block or a bench mounted pneumatic SupaScreen crimping machine. The assembly procedure for a window is the same as for a door.

- Step 1. Fit the Plug (plug 1) onto the Lock side of the sheet - plug will be 16mm shorter at each end of the sheet  
Tap the Lock side Frame onto the sheet until 3 to 4mm of the plug remains showing (refer to partially engaged drawing above)
- Step 2. Tap a corner Stake (stake1) into the Top Frame  
Fit the Plug (plug 2) onto the Top Frame end of the sheet, 16mm in from the edge of the sheet.  
Tap the Top Frame onto the sheet until the plug is fully engaged and the mitre joint is square.
- Step 3. Tap a corner Stake (stake 2) into the Bottom Frame (Lock Frame side).  
Fit the Plug (plug 3) onto the Bottom Frame end of the sheet, 16mm in from the edge of the sheet.  
Tap the Bottom Frame onto the sheet until the plug is fully engaged and the mitre joint is square.
- Step 4. Tap corner Stakes (stakes 3,4) onto Both ends of the Hinge Side Frame  
Fit the Plug (plug 4) onto the Hinge Side Frame end of the sheet  
Tap the Hinge Side Frame onto the sheet until the plug is fully engaged and the mitre joints are square.
- Step 5. Using a plastic block tap the plugs on all sides to ensure they are fully engaged, turn frame over and repeat on the other side  
Tap the corners as necessary to ensure the mitres are closed and check the frame diagonally for squareness.
- Step 6. Drill the frame approximately 40mm from the corners and lock in the corner stakes with s/s pop rivets  
Gently sand the sharpness off the corners.

Clearguard Decorative Castings for Doors

These Cast Panels fix directly to Clearguard, DS Tape and Pop rivetted from the inside  
Allow a minimum of 25mm clearance to Panel edge. All Castings 620mm wide.

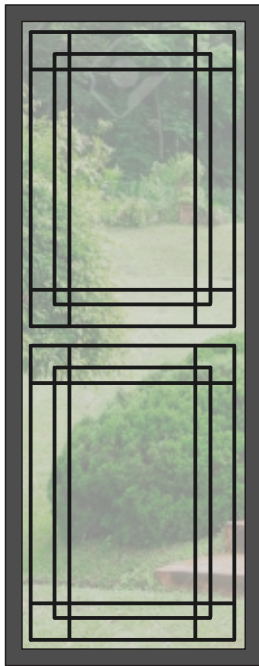

This  
Decorative  
Casting  
895mm high

This  
Decorative  
Casting  
895mm high

Decorative Panel  
Part No JCG/SP72  
Finish - Gull Grey

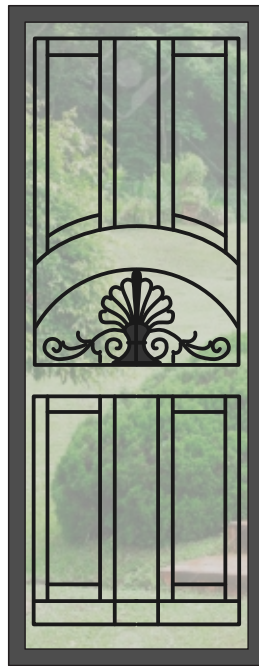

This  
Decorative  
Casting  
995mm high

This  
Decorative  
Casting  
695mm high

Decorative Panel  
Part No JCG/SP74  
Finish - Gull Grey

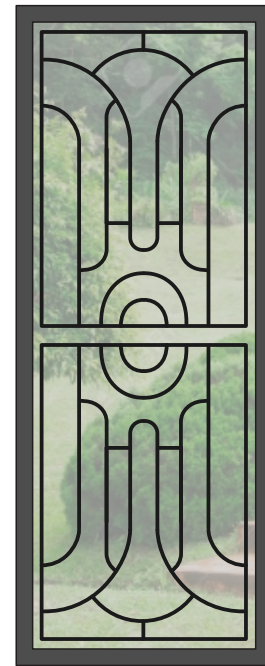

This  
Decorative  
Casting  
895mm high

This  
Decorative  
Casting  
895mm high

Decorative Panel  
Part No JCG/SP81  
Finish - Gull Grey

Clearguard Decorative Castings for Doors - Fitting

- 1 - Apply double sided tape to the decorative panel first , leaving the backing tape on
- 2 - Place the decorative panel in the desired position (with backing tape still on) and drill (3.5mm diameter) through the Clearguard and into the decorative panel , NO MORE THAN 5MM DEEP  
Rivets can be placed in the first holes to keep the panel in place. Do NOT grip the rivets
- 3 - Once all fixing holes are drilled, remove the panel from the Clearguard and clean away any swarf
- 4 - Now remove the backing tape from the decorative panel and place back on the Cearguard aligned with the fixing holes
- 5 - Rivet in place with Truss head size 4-2 rivets (in black)

## Powder Coating Installation Care

### Warning re use of solvents:

- In some cases strong solvents are recommended for thinning various types of paints and also for cleaning up mastics and sealants.
- These can be harmful to the extended life of the powder coated surface, and must not be used for cleaning purposes.
- It is important to note that the damage will not be visible immediately and may take up to 12 months to develop.

If paint splashes or sealants and mastics need to be removed then the following may be safely used:  
Methylated Spirits, Ethyl Alcohol, Isopropanol or preferably a mild detergent in warm water.

### Joinery Protection during Installation:

All the activity on a construction site means that your powder coated items may get knocked or scratched, splattered with mortar, plaster, textured coating or paint during the later stages of construction.

Please ensure that all powder coated articles are masked or covered at this time. It is far easier to prevent accidents than to try and correct them. Should your joinery receive mortar or paint splashes see that these are removed before cure and follow the instructions contained in this brochure.

Typical sticker used to warn other trades of the need to protect and mask off powder coated joinery (applies to anodised joinery also)

**"IMPORTANT ALL TRADES"**  
This valuable aluminium joinery will suffer permanent damage from: plaster, mortar and paint splashes - Protect if splashes occur - Immediately wash down joinery with water or meths - Do not allow splashes to harden! - Do not use solvents! - Do not remove this label until final clean completed.

This photograph displays damage that has occurred on site, post installation. The photo of the masked joinery displays clear signs of damage that could have occurred were it not masked. Please ensure that your joinery is protected right through the entire construction process.



## Powder Coating Maintenance

### External - Maintenance Program:

To extend the life of external powder coated articles and to comply with warranty requirements for powder coated aluminium joinery, a simple, regular maintenance program must be implemented.

The effects of ultra violet light, atmospheric pollution, dirt, grime and airborne salt deposits will all accumulate over time and must be removed or surface staining and weathering will occur, leading to an unsightly appearance.

For external coatings, cleaning should take place every six months. In areas where pollutants are more prevalent, such as beachfront houses and industrial or geothermal areas, then a cleaning program should be carried out on a more frequent basis ie. every one to three months.

### Cleaning your powder coating:

1. Carefully remove any loose surface deposits with a wet sponge.
2. Use a soft brush (non abrasive) and a mild household detergent (do not use solvents) in warm water, remove dust, salt and other deposits.
3. Rinse off with clean fresh water.



### Restoring weathered or scratched surfaces:

Repair of Scuffed or Scratched surfaces  
Dulux Spray Cans are available in all colour card colours.

Repair of Small Scratches or Chips.  
Dulux Dabsticks are ideally suited for the repair of small scratches.  
Dabsticks may not be available in all colour card colours.

Repair of Weathered areas .  
Dulux Gloss Up is a light to medium cutting cream ideally suited for gloss restoration and has been specifically designed for this purpose.  
Gloss Up contains no waxes or silicone and is a one step system.



Contact Dulux Powder Coatings , ph 0064 9 441 8244

All pages © Copyright Juralco Aluminium Building Products Ltd, 2023



**JURALCO**

www.juralco.co.nz ph (09) 478 8018

**Juralco Clearguard® Security Door and Window Systems**

Issue 3-23 v1  
Page 40