



Juralco Balustrade Systems - Interlinking Rails



Juralco Edgetec® JH Clamp Balustrade, Frameless Top Interlinking Handrail.



Edgetec Double Disc Satin Black, Square Trims, with Top Interlinking Rail



Juralco Infinity® Balustrade, Face Fixed, Frameless Post to Wall to secure end of Top Interlinking Rail



Juralco Edgetec® Mini Post, Top Fixed. Showing the Interlinking Top Rail and the use of a Top Mounted Edge Post and Brackets back to the structure



Juralco Edgetec® Mini Post, Face Fixed. Frameless Top Interlinking Handrail.

Juralco Balustrade Systems - Interlinking Rails

Juralco Aluminium Building Products Ltd designs and distributes specialist aluminium joinery systems through a national network of franchised fabricators and agents.

For more than 25 years we have been at the forefront of specialist aluminium door and window products suitable for New Zealand joinery and building methods. Our comprehensive product range includes security and insect screens, balustrades and gates, shutters and awnings, shower screens, wardrobe doors and organisers and internal doors.

This Interlinking Rail manual is designed to be used in conjunction with all our Glass Based Balustrade Systems; Mini Post, Matador Mini Post, Double Disc, Single Disc, Infinity, JH Clamp, EDGE and Viking.

Juralco Frameless Balustrade Systems Interlinking Top Rail conforming to NZ Standard 4223.3.2016 and Building Code Clause B1.3.4

Interlinking Rail - as defined in NZS 4223.3.2016

A rail (normally used with glass barriers) that is connected to each glass pane or to a structural post or other building element. They shall resist the serviceability limit state (SLS) line and concentrated loads in the event of a glass pane breakage

Index

Heading	Pages	Description
Specifications	4	Juralco standard specification sheet and Powder coating recommendations
Configurations	5	Shows typical layouts
Interlinking Rails	6 - 15	Show 38mm Rectangular, 50mm Round and 25, 40mm SS Interlinking Top Rails mounted to the Glass top edge
Stiffener Brackets	16	Shows various Fixed and Adjustable Glass Stiffener Brackets. For Laminated and SentryGlas only
Interlinking Top Rail END attachments	17 - 24	Shows to various Structure types + Attach details Shows different Frameless Balustrade Systems mounted onto EDGE End Posts
Handrails	24- 26	Shows Handrails Side mounting to Glass Panels or Posts (p24), End Plates (p22) and Joiners (p27)
Surface Care	27 - 29	Instructions for the care of Powder coated, Glass and Stainless Steel surfaces

[Use the Bookmarks](#) [List to jump to selected pages](#)



Interlinking Top Rail. 90 deg Joint



Interlinking Top Rail. Angled Joint

Juralco Balustrade Systems - Interlinking Rails

Specifications, Powder Coating

Juralco Aluminium Building Products Ltd (JABP) Specifications for Juralco Interlinking Rail System

1.Scope

- This specification details the documents the Juralco Interlinking Rail System refers to in relation to the New Zealand Building Code, the manufacturer's documents, products used in the System, requirements in relation to fixing and surface finishing.

2. NZBC Compliance

- The Juralco Interlinking Rail System has been reviewed by Lautrec Technology Group Ltd to demonstrate compliance with the structural requirements of the New Zealand Building Code. Juralco Frameless and Semi Frameless Balustrade Systems [Interlinking Top Rail](#) and [Interlinking Rail](#) conform to NZ Standard 4223.3.2016 and Building Code Clause B1.3.4

3. Manufacturer's Documents

- The Juralco Interlinking Rail System manual details all extrusions and components used for the fabrication and installation/fixing of the system.
- A Producer Statement 1(Design) is available.
Copies of the above documents are available from:
Juralco Aluminium Building Products Ltd
48 Bruce McLaren Rd, Henderson, Auckland
Phone 09 478 8018 Fax 09 478 7883 Email specify@juralco.co.nz
- Any deviation from the standard fabrication or installation/fixing must be accompanied by a site specific PS1 with site specific calculations and drawings . Contact Juralco for additional help.

4. Products

- Only extrusions, components and hardware supplied by or specified by JABP may be used in the Juralco Interlinking Rail System
- Aluminium extrusions, components and hardware – unless specified are manufactured to 6060 T5 specifications
- Stainless Steel components, hardware, fixings – all components to 316 grade
- Must only be used in conjunction with approved Juralco Balustrade systems.

5.Surface Finishing

- Juralco Aluminium Building Products Ltd is a Dulux Registered Applicator site, registration number 2101. JABP uses only Dulux branded powder coating materials
- Dulux Duralloy® powder coating systems are suitable for properties greater than 100m from high tide level AAMA 2603 performance. Residential buildings, 3 levels max. Warranty 10 yrs
- Dulux Duralloy Plus® powder coating systems are suitable for properties greater than 10m from high tide level. AAMA 2603 performance. Residential and Light commercial buildings, 3 levels max. Warranty 15 yrs
- Dulux Duratec® powder coating systems are suitable for properties greater than 10m from high tide level AAMA2603 and 2604 performance. All Residential and Commercial buildings. Warranty 25 yrs

6. Installation and Fixing

- The Juralco Interlinking Rail System must only be installed in accordance with the Juralco Interlinking Rail System manual
- The Juralco Interlinking Rail System must only be fabricated/installed by a Juralco approved fabricator
- Upon completion of the installation the fabricator must supply the owner with a PS3 (Construction)

Important information - Powder Coating systems.

Powdercoat Systems The new standard Dulux powder coating system used by Juralco is Duralloy Plus®. Also Duralloy® and Duratec®. All as per specs above. Juralco Powder coated prices are for Duralloy Plus® and Duralloy® (same pricing). Duratec® prices on application.

Attachment to structures A PVC Tape or similar material spacer must be used to separate powder coated aluminium items from all concrete and steel structures. Failure to do so can lead to the chemicals in the structure affecting the powder coating, leading to corrosion.

Swimming Pools The chlorinated water in swimming pools can cause the deterioration of powder coated surfaces, leading to corrosion of the underlying surface. It is recommended that Powder coated surfaces be 1200mm min from a pool.

Care The Dulux powder coating warranty period is conditional upon the surface being maintained in accordance with the Dulux 'Care and Maintenance Instructions'. Download from Dulux or refer to the back page of this manual.

Juralco Balustrade Systems - Interlinking Rails and Handrails

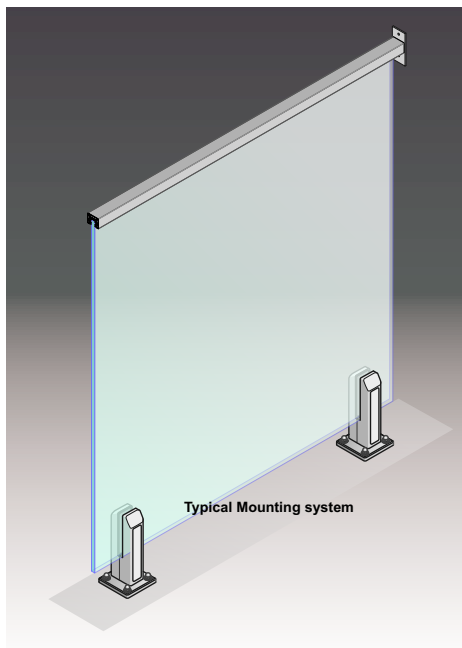

1 - Interlinking Top Rail Mounted to Top of Frameless Glass. Rectangular or Round options for a variety of Glass thicknesses

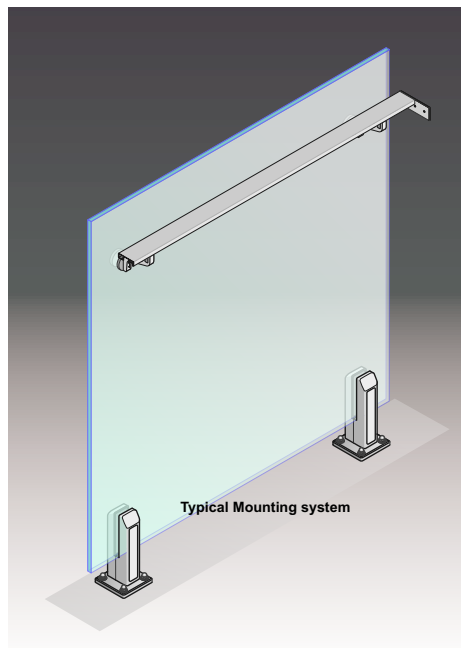

2 - Handrail Mounted to Frameless Glass Panel 4 x Handrail shape options. Applies to a variety of Glass thicknesses

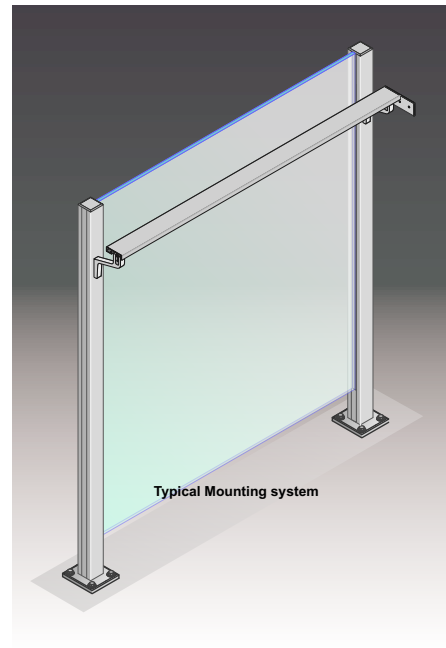

3 - Handrail Mounted to Posts for Semi Frameless Glass 4 x Handrail shape options.

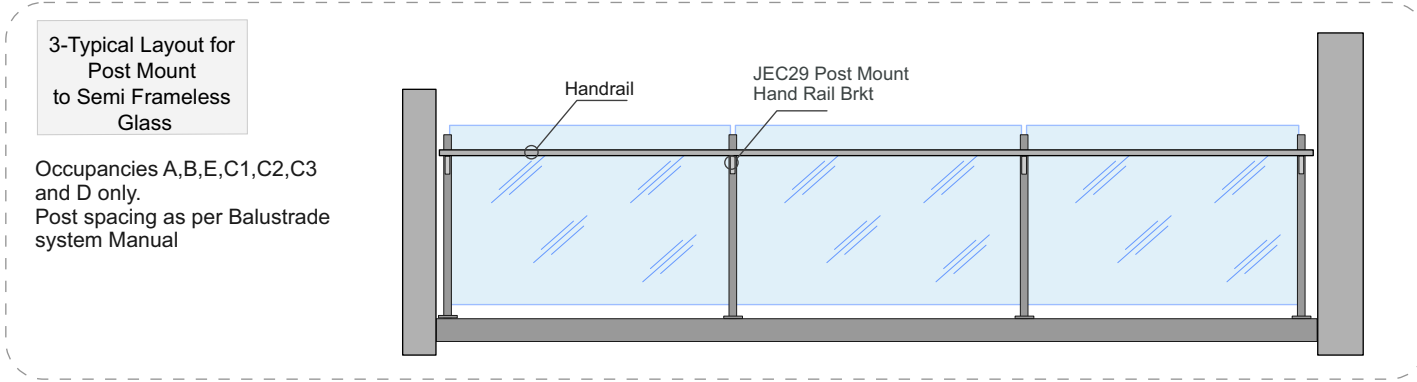
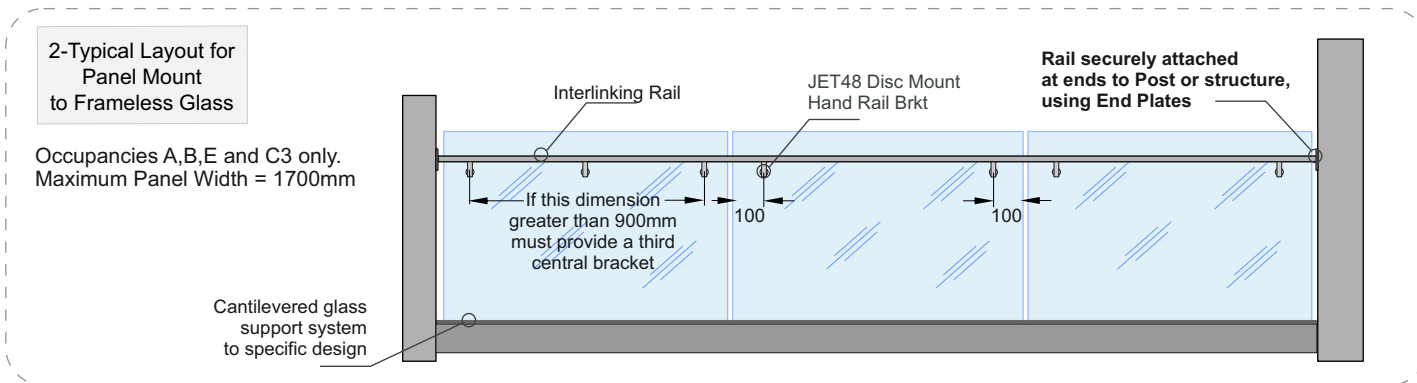
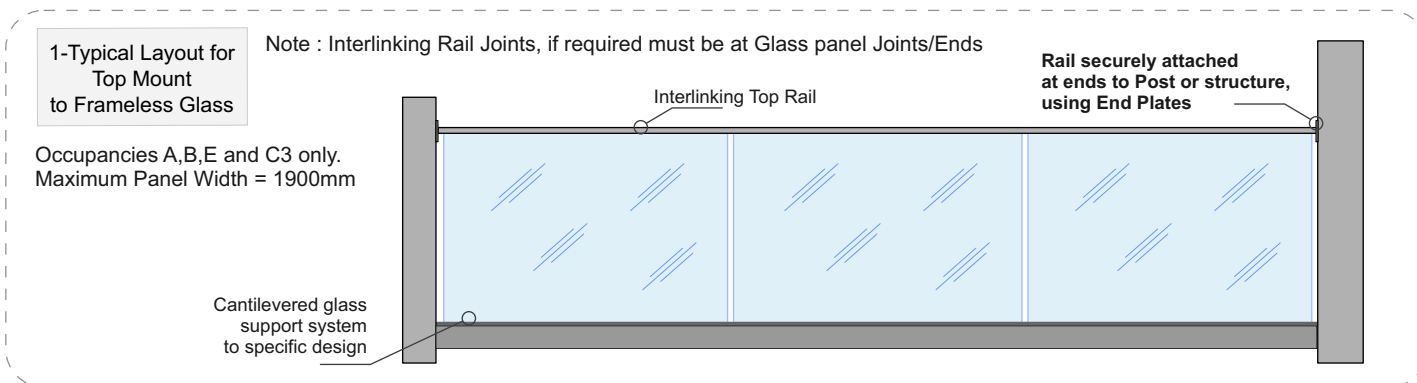

Juralco 38mm Rectangular Interlinking Top Rail

This page applies to 12mm and 15mm Toughened Glass only

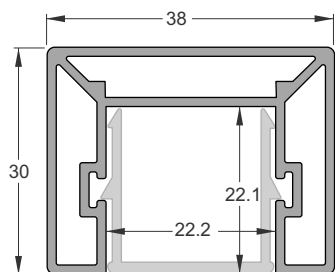

Rectangular Interlinking Top Rail
JET/220/5.8
Also showing Infill Clip, for
use in between Glass Panels

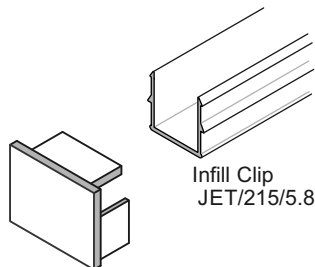

Interlinking Top
Rail End Cap
JET 37

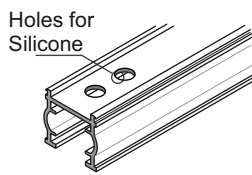

Interlinking Top Rail Gasket
for 12 mm Toughened Glass
JET/Gasket 12/2.9

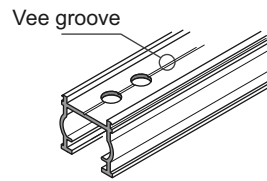

Interlinking Top Rail Gasket
for 15 mm Toughened Glass
JET /Gasket 15/2.9

1 - 12, 15mm Glass and Gasket

Application Notes:

- Cut short lengths of Gasket (50mm) and place say every 700mm.
- Cut/adjust Interlinking rail to correct dimensions and set in place.
- Remove all, install full cut lengths of Gasket to glass top edge

- Assemble Top Rail + Joiners and suitable End plates
- Place blobs of V60 silicone in every Gasket hole
- Then place Top Rail extrusion + Joiners and End plates in place clipping firmly to Gasket
- Tape all down, wait 24 hrs to fully bond. Clean up.

Note: Ends must be attached to structure or post,
- Joins must have a suitable joiner plate

12mm Glass and Gasket shown

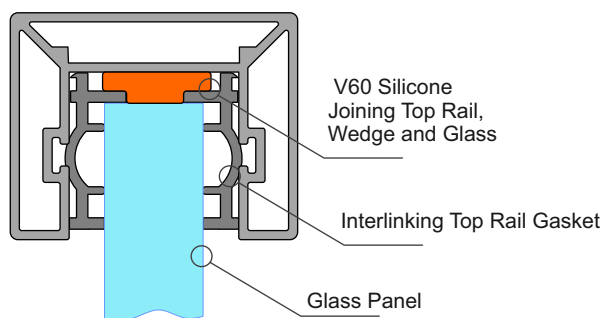

2 - End Plate Brackets

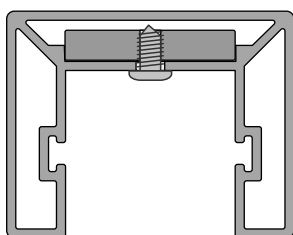

End Plate
Tabs all 22.5 x 4mm SS.

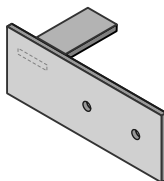

Interlinking Top Rail
Wall type End Plate
SS. 120x45mm
JET 40LH

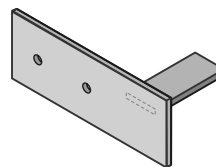

Interlinking Top Rail
Wall type End Plate
SS. 120x45mm
JET 40RH

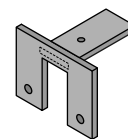

Interlinking Top Rail
End Bracket
SS. 60mm x 46mm
JET 42

(After cutting extrusions to length) - With End Plate in place, spot drill from below for position-
- Drill out to SS tab to 3mm dia, extrusion to 4mm dia - Use No 6 x 1/4in SS ST Pan sq drive Screw,
@ 2 per plate - End Plate must be securely attached to Post or structure.

3 - Joiners

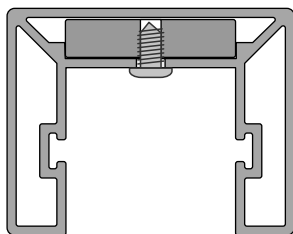

Joiners
22.5 x 5mm Aluminium

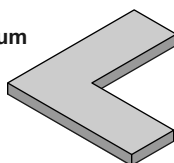

Interlinking Top Rail
Corner Joiner
75x75x5mm
JET 31

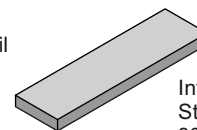

Interlinking Top Rail
Straight Joiner
80x22.8x5mm
JET 30

(After cutting extrusions to length) - With Joiner in place, spot drill from below for position
- Drill out to Joiner to 3mm dia, extrusion to 4mm dia
- Use No 6 x 1/4in SS ST Pan sq drive Screw, @ 2 per plate

Important Note: All Interlinking rails, at their ends must be attached to a Building Structure or to an Edge Post attached to the Deck structure, using Rail End Plates/Brackets



Juralco 38mm Rectangular Interlinking Top Rail

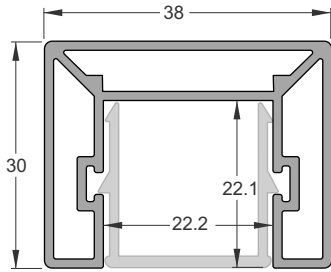

Rectangular Interlinking Top Rail
JET/220/5.8
Also showing Infill Clip, for
use in between Glass Panels

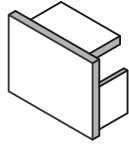

Interlinking Top
Rail End Cap
JET 37

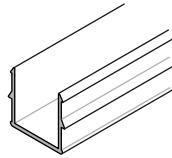

Infill Clip
Part No JET/215/5.8

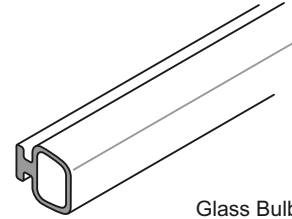

Glass Bulb Seal
Part No JET/IB/CVRBLB250

This Page applies to 15.2mm and 17.2mm Laminated Safety Glass only

1 - 15.2, 17.2mm Glass and Gasket

Application Notes:

- Assemble Top Rail + Joiners and suitable End plates
- Place Full lengths of Bulb seal in place.
- Place blobs of V60 silicone along top edge of Glass at similar spacings to Gasket on previous page.
- Then place Top Rail extrusion and bulb seals firmly onto Glass.
- Tape all down, wait 24 hrs to fully bond. Clean up.

Note: Ends must be attached to structure or post,
- Joins must have a suitable joiner plate

15.2mm Glass and Gasket shown

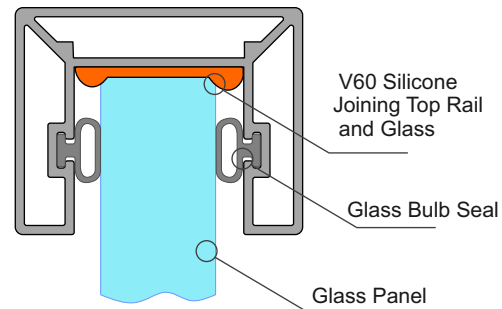

2 - End Plate Brackets

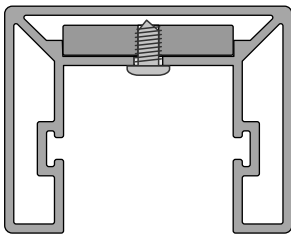

End Plate
Tabs all 22.5 x 4mm SS.

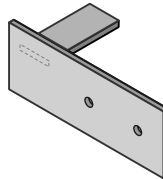

Interlinking Top Rail
Wall type End Plate
SS. 120x45mm
JET 40LH

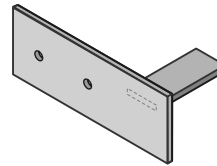

Interlinking Top Rail
Wall type End Plate
SS. 120x45mm
JET 40RH

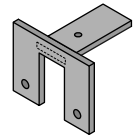

Interlinking Top Rail
End Bracket
SS. 60mm x 46mm
JET 42

(After cutting extrusions to length) - With End Plate in place, spot drill from below for position-
- Drill out to SS tab to 3mm dia, extrusion to 4mm dia - Use No 6 x 1/4in SS ST Pan sq drive Screw,
@ 2 per plate - End Plate must be securely attached to Post or structure.

3 - Joiners

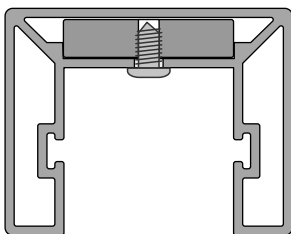

Joiners
22.5 x 5mm Aluminium

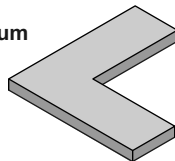

Interlinking Top Rail
Corner Joiner
75x75x5mm
JET 31

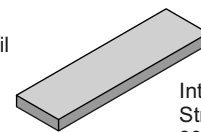

Interlinking Top Rail
Straight Joiner
80x22.8x5mm
JET 30

(After cutting extrusions to length) - With Joiner in place, spot drill from below for position
- Drill out to Joiner to 3mm dia, extrusion to 4mm dia
- Use No 6 x 1/4in SS ST Pan sq drive Screw, @ 2 per plate

Important Note: All Interlinking rails, at their ends must be attached to a Building Structure or to an Edge Post attached to the Deck structure, using Rail End Plates/Brackets

Juralco 38mm Rectangular Interlinking Top Rail - Corner Connectors

1 - Connectors

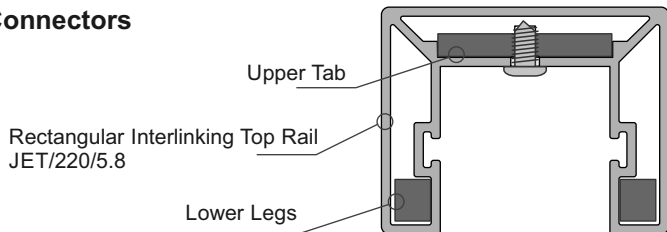

- Swivel Kits: (After cutting extrusions to length)
- With Swivel in place, spot drill from below for position
 - Drill out Swivel to 3mm dia, extrusion to 4mm dia
 - Use No6 x 1/4in SS ST Pan sq drive screws, 2 x ea side of joint
 - Both sides must be attached.
 - Join together with the M6 x 25 C/S SS Screw

Interlinking Top Rail Horizontal Fixed 90 deg Connector JET 45A

Interlinking Top Rail Horizontal Fixed 90 deg Connector JET 45B

Rectangular Interlinking Top Rail Horizontal Fixed 90deg Kit JET220/90deg Corner Kit (JET 45A and B + screw)

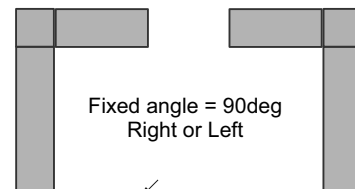
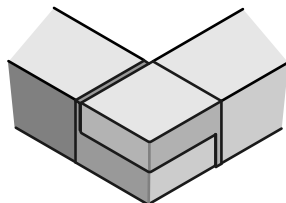
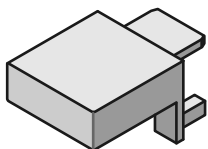
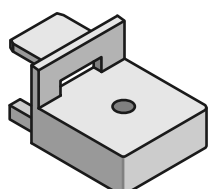

Fixed angle = 90deg Right or Left

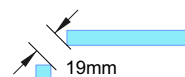

Glass corner Gap = 19mm min

M6 x 25 C/S SS machine screw

Interlinking Top Rail Horizontal 0 - 90deg Swivel Connector JET 46A

Interlinking Top Rail Horizontal 0 - 90deg Swivel Connector JET 46B

Rectangular Interlinking Top Rail Horizontal 0 - 90 deg Right/Left Swivel Connector Kit JET220/Horizontal Adj Corner Kit (JET 46A and B + screw)

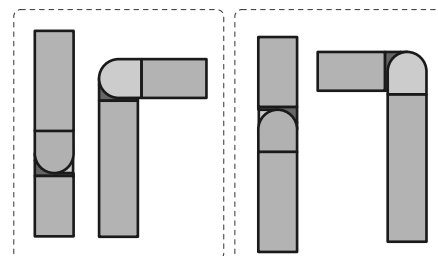
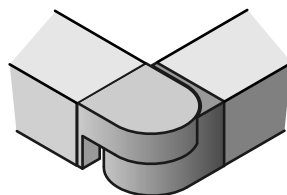
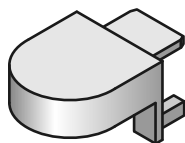
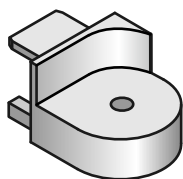

Variable angle = 0 - 90deg Right or Left

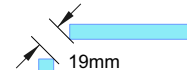

Glass corner Gap = 19mm min

M6 x 25 C/S SS machine screw

Interlinking Top Rail Vertical 35deg up to 35 deg down Swivel Connector JET 47A

Interlinking Top Rail Vertical 35deg up to 35 deg down Swivel Connector JET 47B

M6 x 25 C/S SS machine screw

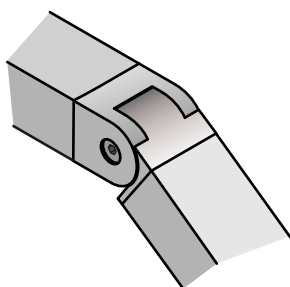
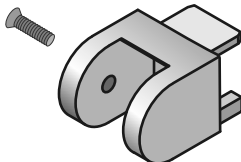
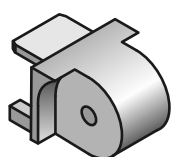

Interlinking Top Rail Vertical 35deg up to 35 deg down Swivel Connector Kit JET220/Vertical Adj Corner Kit (JET 47A and B + screw)

Max down = 35deg

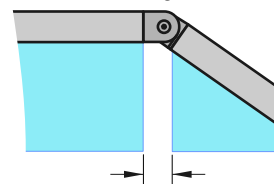

Gap 30mm min 40mm recommended

Max up = 35deg

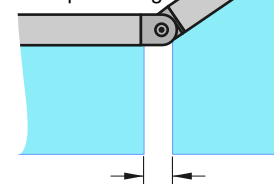

Gap 30mm min 40mm recommended

Juralco 50mm Round Interlinking Top Rail

This page applies to 12mm and 15mm Toughened Glass only

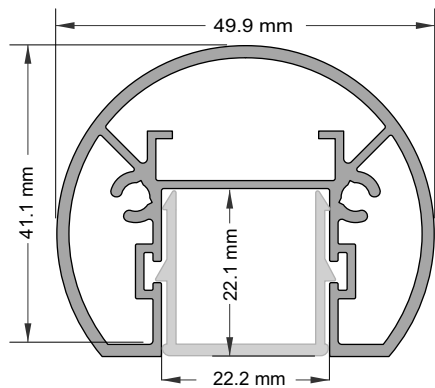

Round Interlinking Top Rail
JET/211/5.8
Also showing Infill Clip, for use in between Glass Panels

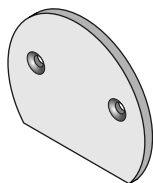

Round Interlinking Top Rail End Cap
JET/231

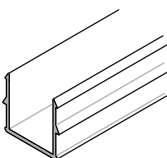

Infill Clip
Part No JET/215/5.8

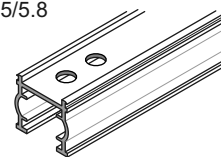

Interlinking Top Rail Gasket for 12 mm Toughened Glass
JET /Gasket 12/2.9

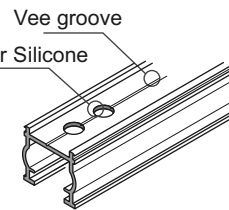

Interlinking Top Rail Gasket for 15 mm Toughened Glass
JET /Gasket 15/2.9

1 - 12, 15mm Glass and Gasket

Application Notes:

- Cut short lengths of Gasket (50mm) and place say every 700mm.
- Cut/adjust Interlinking rail to correct dimensions, test in place.
- Remove all, install full cut lengths of Gasket to glass top edge
- Assemble Top Rail + Joiners and suitable End plates
- Place blobs of V60 silicone in every Gasket hole
- Then place Top Rail extrusion + Joiners and End plates in place clipping firmly to Gasket
- Tape all down, wait 24 hrs to fully bond. Clean up.

Note: Ends must be attached to structure or post,
- Joins must have a suitable joiner plate

12mm Glass and Gasket shown

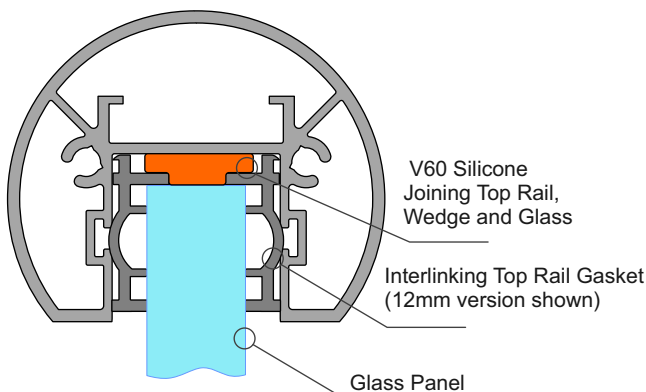

2 - End Plate Brackets

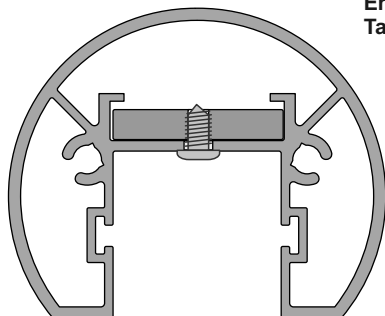

End Plate
Tabs all 22.5 x 4mm SS.

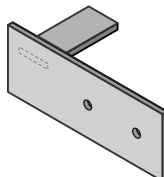

Interlinking Top Rail
Wall type End Plate
SS. 120x45mm
JET 40LH

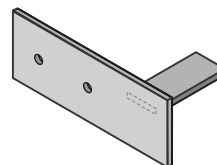

Interlinking Top Rail
Wall type End Plate
SS. 120x45mm
JET 40RH

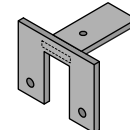

Interlinking Top Rail
End Bracket
SS. 60mm x 46mm
JET 42

(After cutting extrusions to length) - With End Plate in place, spot drill from below for position
- Drill out to SS tab to 3mm dia, extrusion to 4mm dia - Use No 6 x 1/4in SS ST Pan sq drive Screw,
@ 2 per plate - End Plate must be securely attached to Post or structure.

3 - Joiners

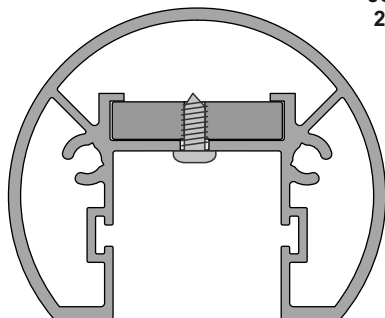

Joiners
22.5 x 5mm Aluminium

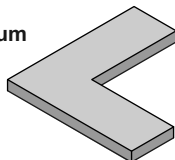

Interlinking Top Rail
Corner Joiner
75x75x5mm
JET 31

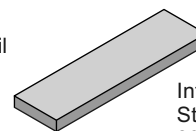

Interlinking Top Rail
Straight Joiner
80x22.8x5mm
JET 30

(After cutting extrusions to length) - With Joiner in place, spot drill from below for position
- Drill out to Joiner to 3mm dia, extrusion to 4mm dia
- Use No 6 x 1/4in SS ST Pan sq drive Screw, @ 2 per plate

Important Note: All Interlinking rails, at their ends must be attached to a Building Structure or to an Edge Post attached to the Deck structure, using Rail End Plates/Brackets



Juralco 50mm Round Interlinking Top Rail

This Page applies to 15.2mm and 17.2mm Laminated Safety Glass only

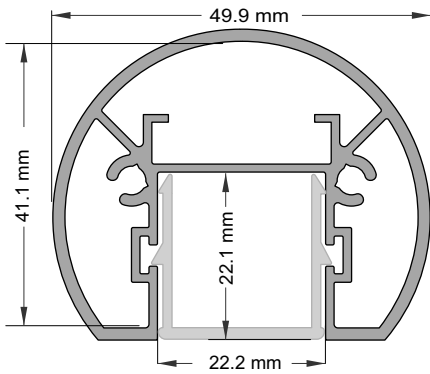

Round Interlinking Top Rail
JET/211/5.8
Also showing Infill Clip, for use in between Glass Panels

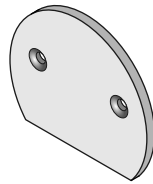

Round Interlinking Top Rail End Cap
JET 231

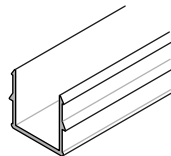

Infill Clip
JET/215/5.8

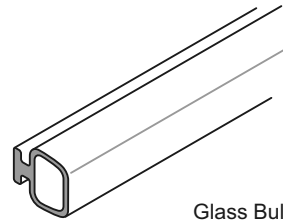

Glass Bulb Seal
JET/IB/CVRBLB250

1 - 15.2, 17.2mm Glass and Gasket

15.2mm Glass and Gasket shown

Application Notes:

- Assemble Top Rail + Joiners and suitable End plates
- Place Full lengths of Bulb seal in place.
- Place blobs of V60 silicone along top edge of Glass at similar spacings to Gasket on previous page.
- Then place Top Rail extrusion and bulb seals firmly onto Glass.
- Tape all down, wait 24 hrs to fully bond. Clean up.

Note: Ends must be attached to structure or post,
- Joins must have a suitable joiner plate

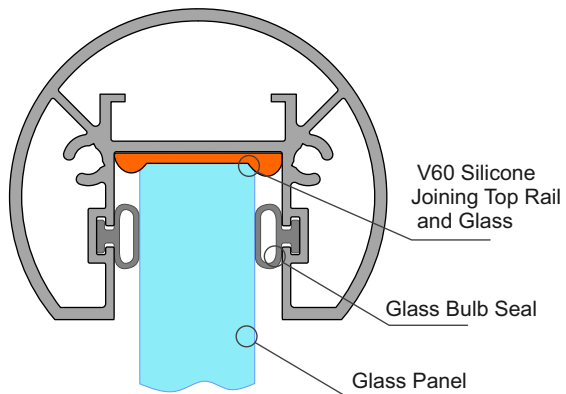

2 - End Plate Brackets

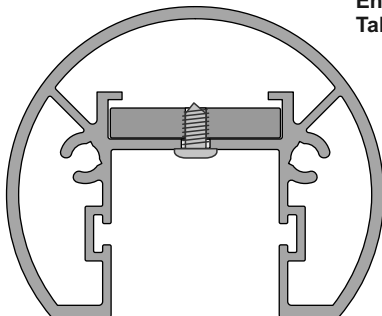

End Plate
Tabs all 22.5 x 4mm SS.

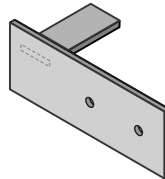

Interlinking Top Rail
Wall type End Plate
SS. 120x45mm
JET 40LH

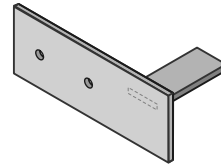

Interlinking Top Rail
Wall type End Plate
SS. 120x45mm
JET 40RH

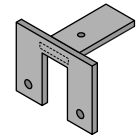

Interlinking Top Rail
End Bracket
SS. 60mm x 46mm
JET 42

(After cutting extrusions to length) - With End Plate in place, spot drill from below for position
- Drill out to SS tab to 3mm dia, extrusion to 4mm dia - Use No 6 x 1/4in SS ST Pan sq drive Screw,
@ 2 per plate - End Plate must be securely attached to Post or structure.

3 - Joiners

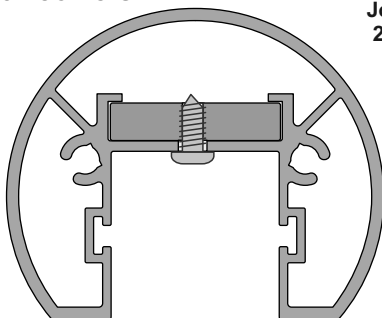

Joiners
22.5 x 5mm Aluminium

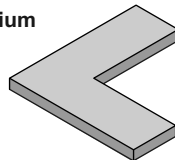

Interlinking Top Rail
Corner Joiner
75x75x5mm
JET 31

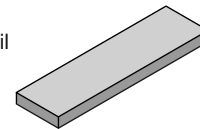

Interlinking Top Rail
Straight Joiner
80x22.8x5mm
JET 30

(After cutting extrusions to length) - With Joiner in place, spot drill from below for position
- Drill out to Joiner to 3mm dia, extrusion to 4mm dia
- Use No 6 x 1/4in SS ST Pan sq drive Screw, @ 2 per plate

Important Note: All Interlinking rails, at their ends must be attached to a Building Structure or to an Edge Post attached to the Deck structure, using Rail End Plates/Brackets

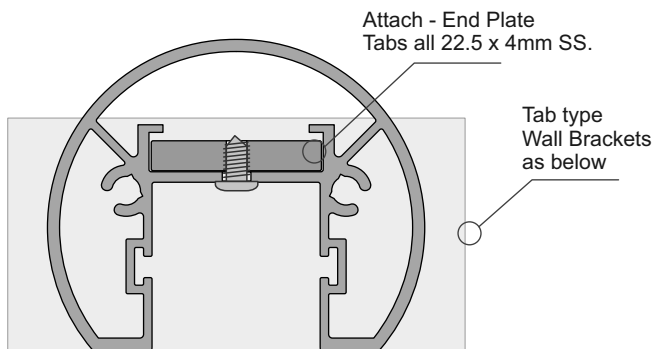

Round Interlinking Top Rail Extrusion
JET/211/5.8

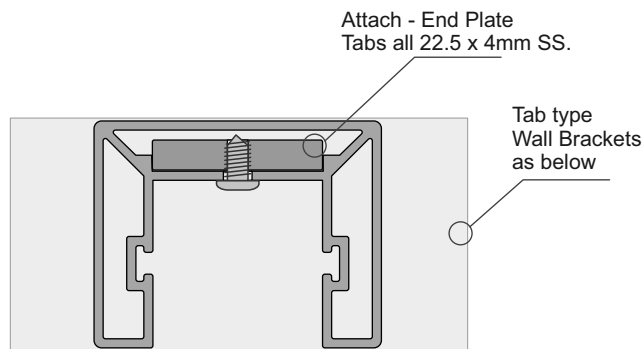

Interlinking Top Rail Extrusion
JET/220/5.8

Interlinking Top Rail End Bracket Options - Both types above - Tab attach Type

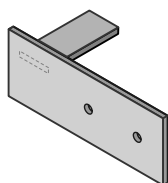

Interlinking Top Rail
Wall type End Plate
SS. 120x45mm
JET 40LH

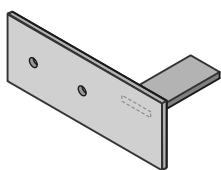

Interlinking Top Rail
Wall type End Plate
SS. 120x45mm
JET 40RH

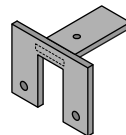

Interlinking Top Rail
End Bracket
SS. 60mm x 46mm
JET 42

**Tabs all 22.5 x 4mm SS.
Front faces all 3mm SS**

Interlinking Top Rail End Bracket Options - Round Type only - Attach into Screw ports

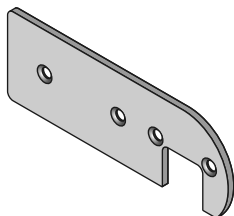

Interlinking Top Rail
Wall type offset End Plate
Round Rail type only
120x42x3mm, Al
C/s both sides = RH or LH
JET 233

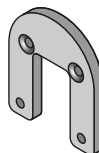

Interlinking Top Rail
Wall type End Plate
Round Rail type only
50x58x5mm, Al
JET 232

General Notes:

- All fixings to be Stainless Steel - PVC Tape layer between Structure and Bracket
- ULS Point load $N^* = 0.9kN$, inwards, outwards or down and in tension

Note : Fixing to Steel

- use 2 off 8g SS TEK Screws or M6 SS Bolts
- Steel 2mm min thickness
- Steel 300MPa minimum
- 15mm min distance to any Edges

Note : Fixing to Timber Wall

- use 2 off 8g SS Screws, 35mm min into studs.
- use Sika Supergrip30
- 30mm min distance to Horizontal Edge
- If Weatherboard use suitable predrilled Wedge
- Timber stud wall to be designed and detailed in accordance with NZS3603 or NZS3604

Note : Fixing to Juralco EDGE Post

- use 2 off 8g x 25 SS PK Screws

Note : Fixing to Concrete Wall

- use 2 off M6 x70 SS Screw Anchors
- Solid Concrete min 20Mpa
- Block wall Concrete filled/Reinforced
- 140mm min Wall thickness
- 70mm min distance to Horizontal Edge
- 100mm min distance to Vertical Edge
- Blockwork wall must be corefilled /reinforced and is to be designed and detailed in accordance with NZS4230 or NZS4229

Important Note: All Interlinking rails, at their ends must be attached to a Building Structure or to an Edge Post attached to the Deck structure, using Rail End Plates/Brackets

Small SS Interlinking Top Rail

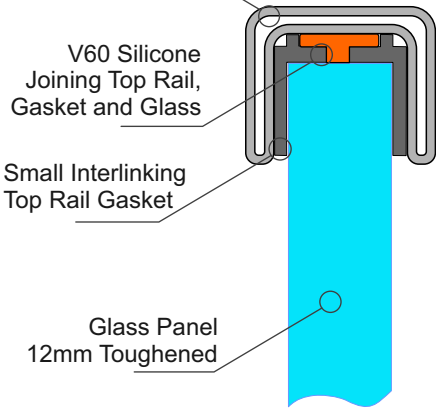

25mm SS Interlinking Top Rail

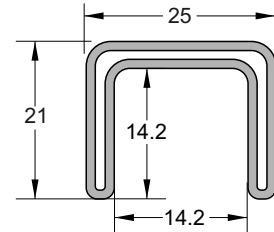
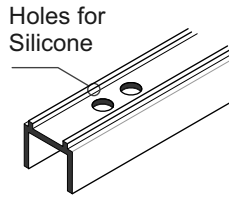

SMALL SS INTERLINKING TOP RAIL GASKET
JET/490GT/12/2.9 (Black)

SMALL SS INTERLINKING TOP RAIL
JET/490/5.8/SSS JET/490/5.8/SCC
Duplex 2205

25mm SS Interlinking Rail Connections

Note : All these Brackets use M5 x 6 SS Grub Screws.
If necessary these holes must be Drilled + tapped M5, as shown.
The under side of the Interlinking Rail must be drilled M6 to match M5 tapped holes positions, for access to Grub screws Joins, where required must be at the end of Glass Panels
Duplex 2205 construction
Available as Satin(SSS) or Powdercoated SCC finishes

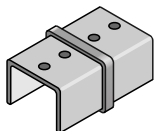
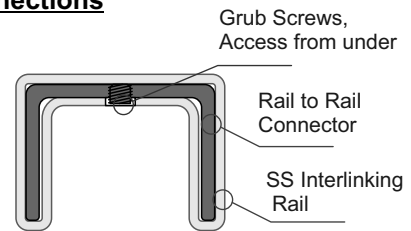

180deg INLINE JOINER
JET491/SSS JET491/SCC
21mm x 25mm x 51mm deep

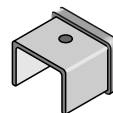

END CAP
JET492/SSS JET492/SCC
21mm x 25mm x 25mm deep

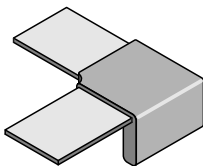

90deg JOINER
JET493/SSS JET493/SCC
21mm x 80mm x 80mm

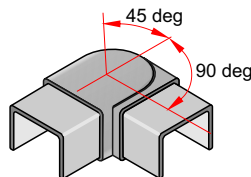

+90 to - 45 deg ADJUSTABLE
HORIZONTAL JOINER
JET494/SSS JET494/SCC
21mm x 25mm x 75mm overall deep

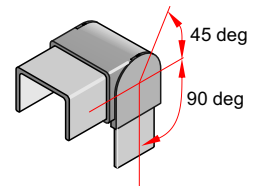

+90 to - 45 deg ADJUSTABLE
VERTICAL JOINER
JET495/SSS JET495/SCC
21mm x 25mm x 73mm overall deep

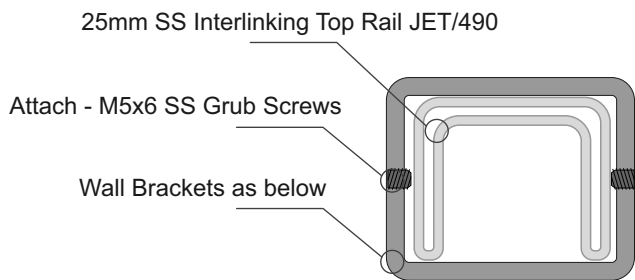

Brackets for Fixing to Wall or End Post for 25mm SS Interlinking Rail

Notes : All these Brackets use M5 x 6mm SS Grub Screws
 - Duplex 2205 construction
 - Available as Satin SS (SSS) or Powdercoat (SCC)

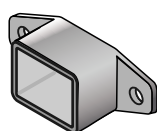
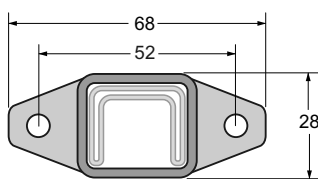

WALL BRACKET
 JET496/SSS JET/496/SCC
 68mm x 28mm x 30mm deep

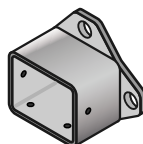
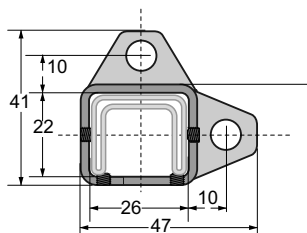

WALL BRACKET - RH.
 JET497/RH/SSS JET497/RH/SCC
 41mm x 47mm x 30mm deep

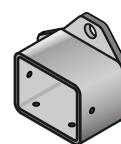
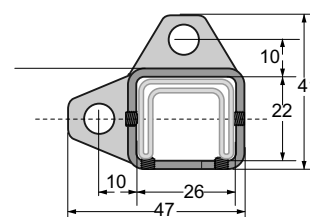

WALL BRACKET - LH
 JET497/LH/SSS JET497/RH/SCC
 41mm x 47mm x 30mm deep

General Notes:

- All fixings to be Stainless Steel. - PVC Tape layer between Structure and Bracket
- ULS Point load N* = 0.9kN, inwards, outwards or down and in tension

Note : Fixing to Steel

- use 2 off 8g SS TEK Screws or M6 SS Bolts
- Steel 2mm min thickness
- Steel 300MPa minimum
- 15mm min distance to any Edges

Note : Fixing to Timber Wall

- use 2 off 8g SS Screws, 35mm min into studs.
- use Sika Supergrip30
- 30mm min distance to Horizontal Edge
- If Weatherboard use suitable predrilled Wedge
- Timber stud wall to be designed and detailed in accordance with NZS3603 or NZS3604

Note : Fixing to Juralco EDGE Post

- use 2 off 8g x 25 SS PK Screws

Note : Fixing to Concrete Wall

- use 2 off M6 x70 SS Screw Anchors
- Solid Concrete min 20Mpa
- Block wall Concrete filled/Reinforced
- 140mm min Wall thickness
- 70mm min distance to Horizontal Edge
- 100mm min distance to Vertical Edge
- Blockwork wall must be corefilled /reinforced and is to be designed and detailed in accordance with NZS4230 or NZS4229

Important Note: All Interlinking rails, at their ends must be attached to a Building Structure or to an Edge Post attached to the Deck structure, using Rail End Plates/Brackets

Juralco 40mm SS Interlinking Top Rail

This page applies to 12mm and 15mm Toughened Glass and 15.2mm and 17.2mm Laminated Glass only

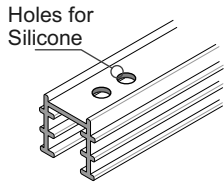

SS Interlinking Top Rail
12mm Glass Gasket
JET/430GT/12/2.9

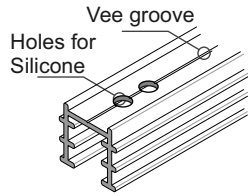

SS Interlinking Top Rail
15mm Glass Gasket
JET/430GT/15/2.9

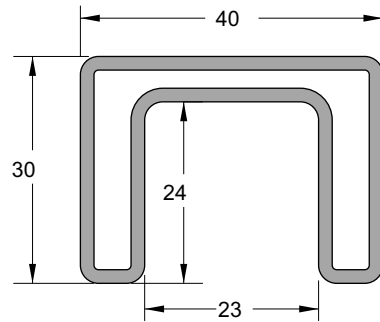

40 SS INTERLINKING TOP RAIL
JET/430/PSS/5.8

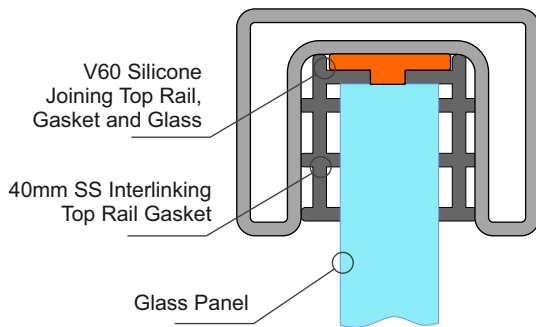

Use Gasket for 12mm and 15mm Toughened Glass

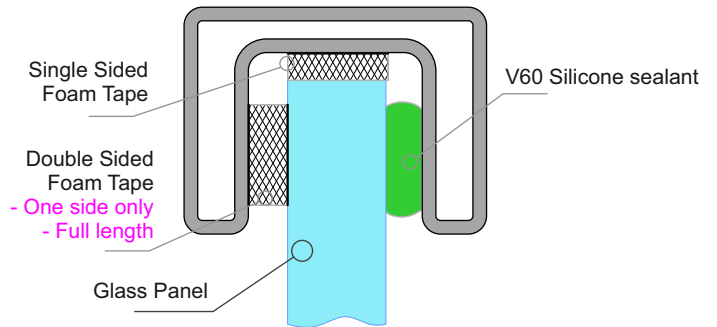

Use Foam Tape for 15.2mm and 17.2mm Laminated Glass

40mm SS Interlinking Rail Connectors

Note : All these Brackets use M5 x 6 SS Grub Screws. If necessary these holes must be Drilled + tapped M5, as shown. The under side of the Interlinking Rail must be drilled M6/7 to match M5 tapped holes positions, for access to Grub screws. Joins, where required must be at the end of Glass Panels Duplex 2205 construction. Available as Polished SS (PSS) only

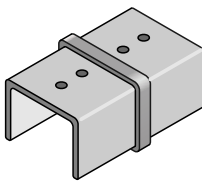
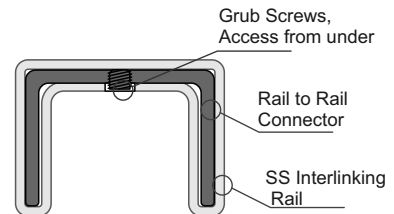

180deg INLINE JOINER Duplex 2205
JET/431/PSS
60mm x 40mm x 30mm deep

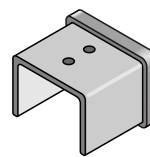

END CAP Duplex 2205
JET/432/PSS
33mm x 40mm x 30mm deep

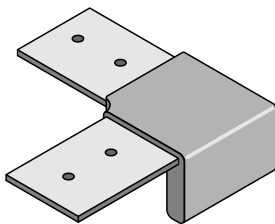

90deg JOINER Duplex 2205
JET/433/PSS
95mm x 95mm x 30mm deep

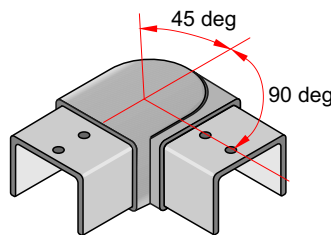

+90 to - 45 deg ADJUSTABLE
HORIZONTAL JOINER Duplex 2205
JET/434/PSS
70mm x 70mm x 30mm deep

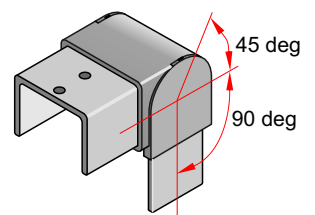

+90 to - 45 deg ADJUSTABLE
VERTICAL JOINER Duplex 2205
JET/435/PSS
60mm x 60mm x 40mm wide

This page applies to 12mm and 15mm Toughened Glass and 15.2mm and 17.2mm Laminated Glass only

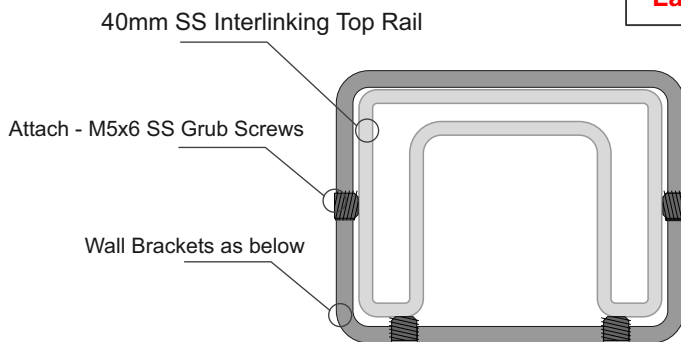

SS INTERLINKING TOP RAIL
JET/430/PSS/5.8

Brackets for Fixing to Wall or End Post for 40mm SS Interlinking Rail

Notes : All these Brackets use M5 x 8mm SS Grub Screws

- Duplex 2205 construction
- Available as Polished SS (PSS) only

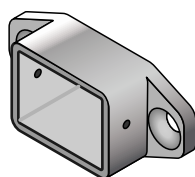
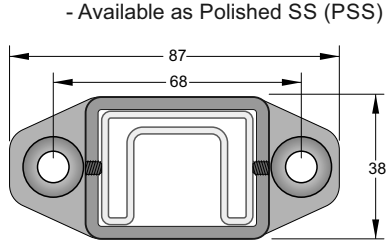

WALL BRACKET 2 FIX
JET/436/PSS
87mm x 37mm x 25mm deep

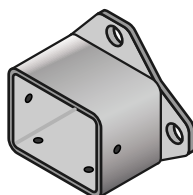
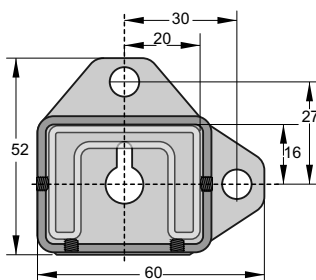

WALL BRACKET 2 FIX - RH
JET/437/RH/PSS
52mm x 60mm x 33mm deep

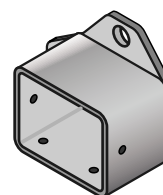
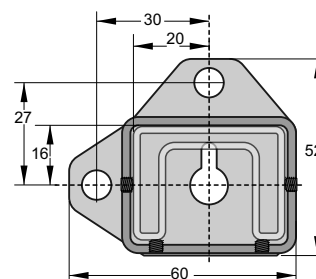

WALL BRACKET 2 FIX - LH
JET/437/LH/PSS
52mm x 60mm x 33mm deep

General Notes:

- All fixings to be Stainless Steel - PVC Tape layer between Structure and Bracket
- ULS Point load $N^* = 0.9kN$, inwards, outwards or down and in tension

Note : Fixing to Steel

- use 2 off 8g SS TEK Screws or M6 SS Bolts
- Steel 2mm min thickness
- Steel 300MPa minimum
- 15mm min distance to any Edges

Note : Fixing to Juralco EDGE Post

- use 2 off 8g x 25 SS PK Screws

Note : Fixing to Timber Wall

- use 2 off 8g SS Screws, 35mm min into studs.
- use Sika Supergrip30
- 30mm min distance to Horizontal Edge
- If Weatherboard use suitable predrilled Wedge
- Timber stud wall to be designed and detailed in accordance with NZS3603 or NZS3604

Note : Fixing to Concrete Wall

- use 2 off M6 x70 SS Screw Anchors
- Solid Concrete min 20Mpa
- Block wall Concrete filled/Reinforced
- 140mm min Wall thickness
- 70mm min distance to Horizontal Edge
- 100mm min distance to Vertical Edge
- Blockwork wall must be corefilled /reinforced and is to be designed and detailed in accordance with NZS4230 or NZS4229

Important Note: All Interlinking rails, at their ends must be attached to a Building Structure or to an Edge Post attached to the Deck structure, using Rail End Plates/Brackets

Juralco Glass Panel Stiffener Brackets

**Applies to 15.2mm Toughened Laminated Glass and 15.52mm SentryGlas.
Also for 12mm Toughened Glass for Pool Fences only**

Top Edge, Frameless Glass Stiffeners.

- Install 200mm max from Glass Top edge
- Supplied as a kit, with screws, a variety of Gaskets and a SS clamp Plate
- Duplex 2205 SS construction. Polished (PSS), Satin (SSS) or Powder coat SCC Finishes

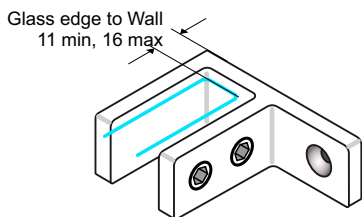

90 Deg Glass to Wall
75x505x25mm
JET/72/PSS
JET/72/SSS
JET/72/SCC

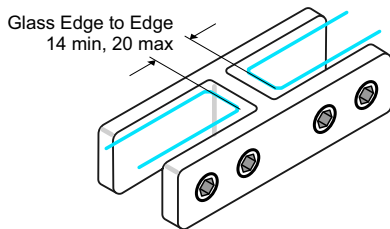

180 Deg Glass to Glass
70x34x25mm
JET/71/PSS
JET/71/SSS
JET/71/SCC

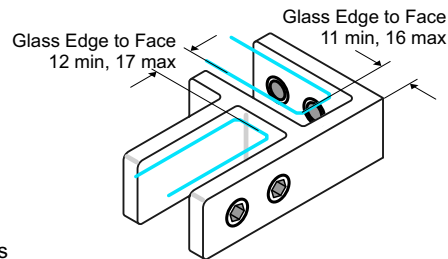

90 deg Glass to Glass
65x55x25mm
JET/70/PSS
JET/70/SSS
JET/70/SCC

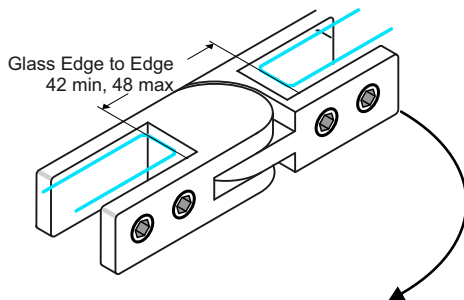

90 - 180 Deg Adjustable Glass to Glass
135x34x25mm
JET/73/PSS
JET/73/SSS
JET/73/SCC

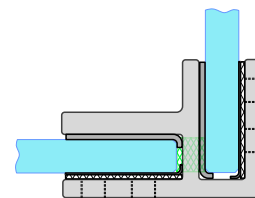

Top Edge, Frameless Glass Stiffeners.

- Install 200mm max from Glass Top edge
- Supplied as a kit, with screws, a variety of Gaskets and a SS clamp Plate
- Duplex 2205 SS construction. Polished (PSS), Satin (SSS) or Powder coat SCC Finishes

**Applies to 17.2mm Toughened Laminated Glass and 17.52mm SentryGlas only.
Up to max Barrier height 1250mm**

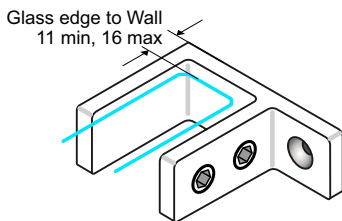

90 Deg Glass to Wall
65x55x25mm
JET/82/PSS
JET/82/SSS
JET/82/SCC

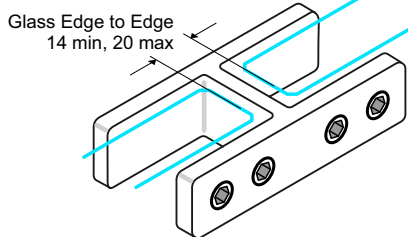

180 Deg Glass to Glass
103x39x25mm
JET/81/PSS
JET/81/SSS
JET/81/SCC

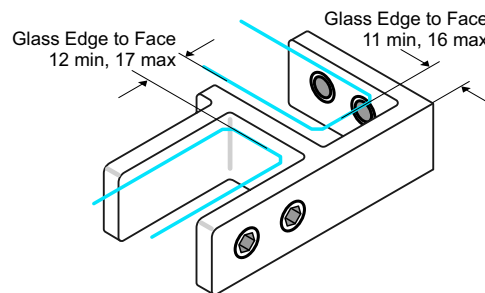

90 deg Glass to Glass
88x55x25mm
JET/80/PSS
JET/80/SSS
JET/80/SCC

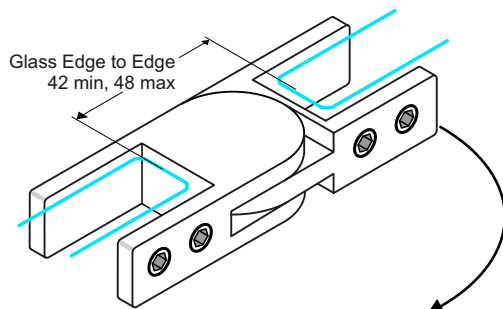

90 - 180 Deg Adjustable Glass to Glass
145x39x25mm
JET/83/PSS
JET/83/SSS
JET/83/SCC

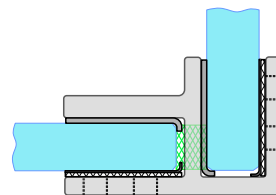

**Juralco Interlinking Top Rail End Bracket
fixing to a Timber Wall**

**Applies to 38mm Rectangular and
50mm Round Interlinking Top Rails only**

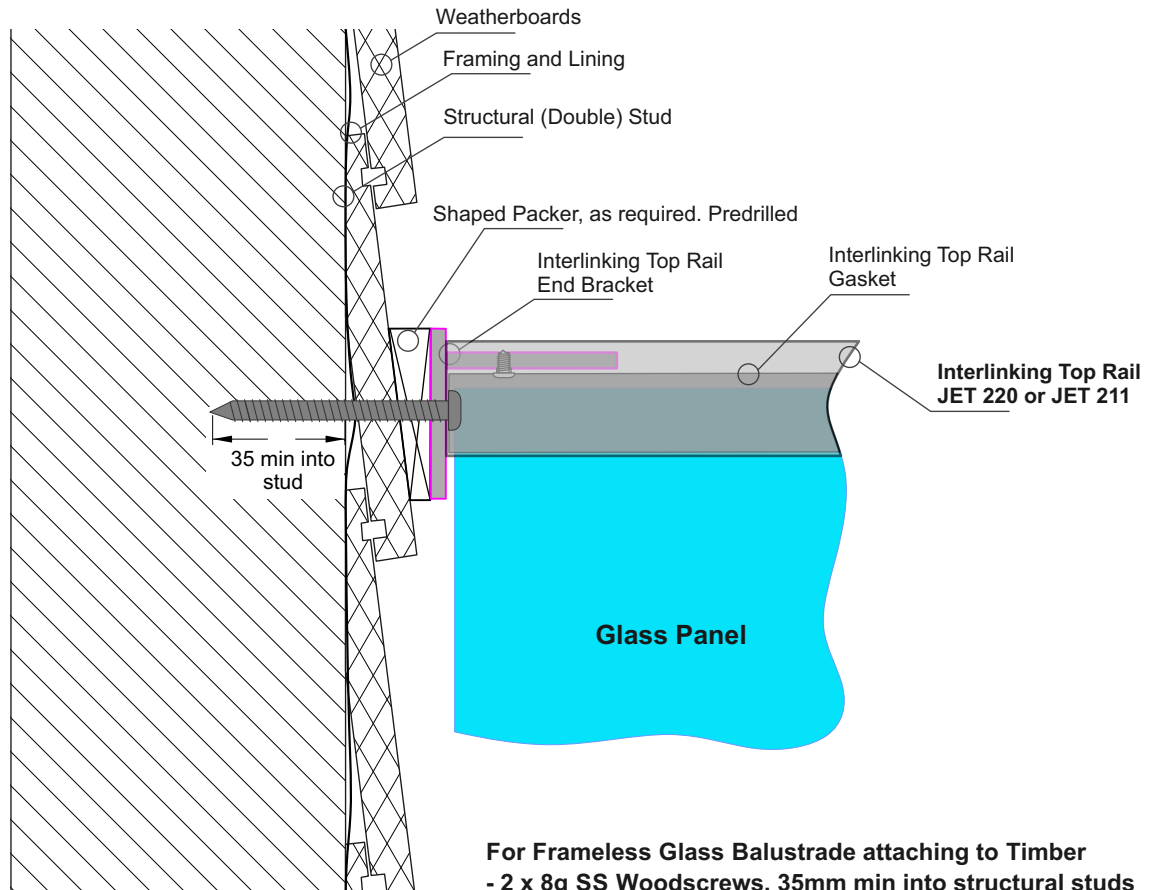

For Frameless Glass Balustrade attaching to Timber
- 2 x 8g SS Woodscrews, 35mm min into structural studs
- 20mm min to edge of stud in all directions

Interlinking Top Rail End Bracket Options - Drawing above shows JET40

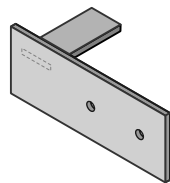

Interlinking Top Rail
Wall type End Plate
SS. 120x45mm
JET 40LH

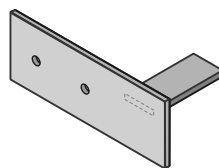

Interlinking Top Rail
Wall type End Plate
SS. 120x45mm
JET 40RH

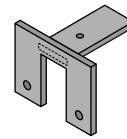

Interlinking Top Rail
End Bracket
SS. 60mm x 46mm
JET 42

Notes:

- All fixings to be stainless steel
- Timber stud wall to be designed by Project structural engineer for loads imposed by Balustrade.
- ULS Point load $N^* = 0.9\text{kN}$, inwards, outwards or down.
- Minimum Stud size = 90mm x 45mm
- Minimum Timber grade = SG8
- Timber stud wall to be designed and detailed in accordance with NZS1720.1.2002 or NZS3604

**Juralco Interlinking Top Rail End Bracket
fixing to a Concrete Wall**

**Applies to 38mm Rectangular and
50mm Round Interlinking Top Rails only**

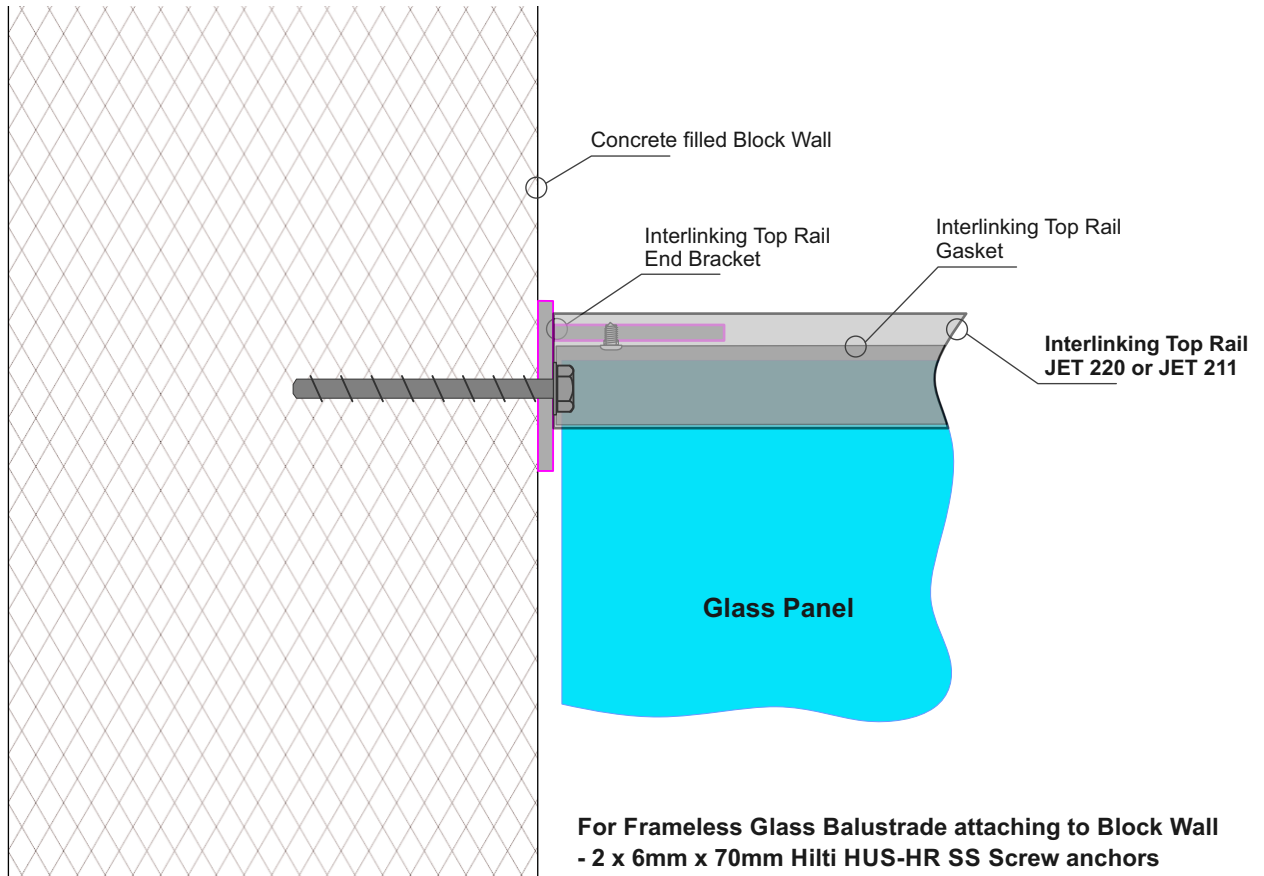

For Frameless Glass Balustrade attaching to Block Wall
 - 2 x 6mm x 70mm Hilti HUS-HR SS Screw anchors
 - For concrete drill 6mmØ holes
 - 70mm min to side edge of concrete, 100mm to top edge.

Interlinking Top Rail End Bracket Options - Drawing above shows JET40

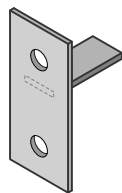

Interlinking Top Rail
Wall type End Plate
SS. 100x45mm
JET 38

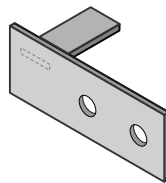

Interlinking Top Rail
Wall type End Plate
SS. 120x45mm
JET 40LH

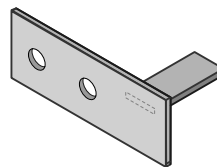

Interlinking Top Rail
Wall type End Plate
SS. 120x45mm
JET 40RH

Drill out holes to 9mmØ

Notes:

- All fixings to be stainless steel
- Blockwall to be designed by Project structural engineer for loads imposed by Balustrade.
- Minimum blockwork thickness = 140mm
- Minimum core fill concrete strength = 20MPa
- Blockwork wall must be corefilled /reinforced and is to be designed and detailed in accordance with NZS4230 or NZS4229

**Interlinking Top Rail for attaching to a Edge balustrade End Post
where Wall fixing not suitable**

Refer to Specific
Juralco Balustrade
manuals for further
fixing details

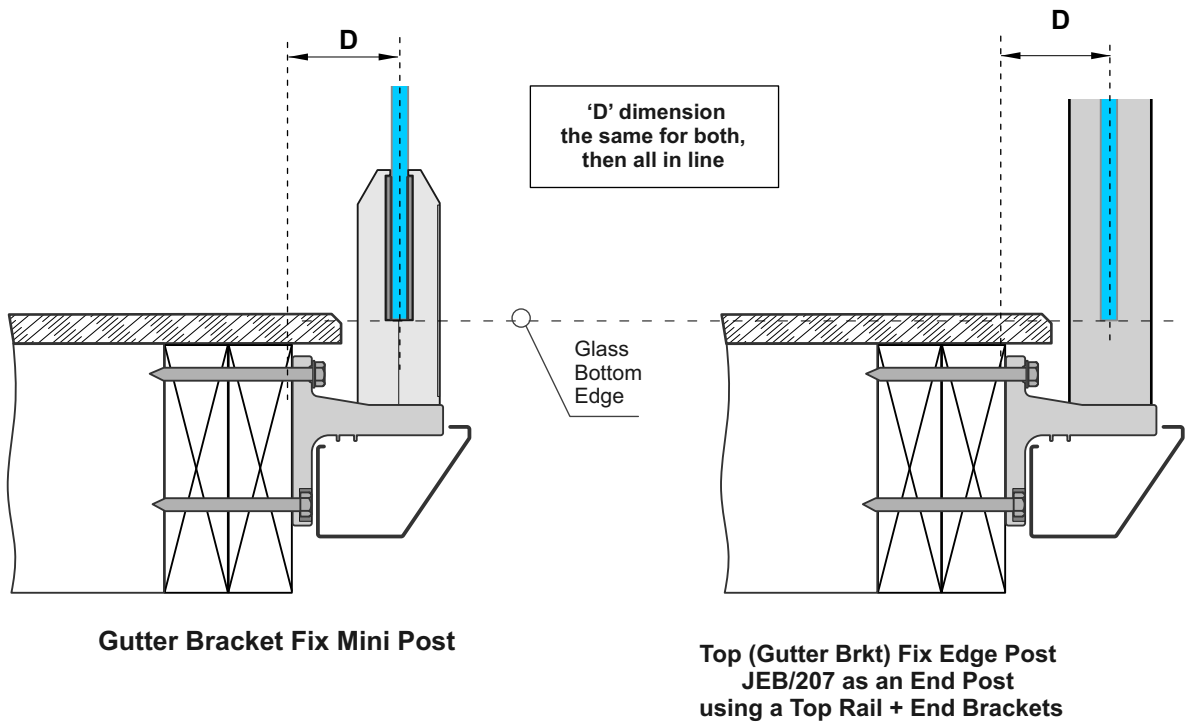
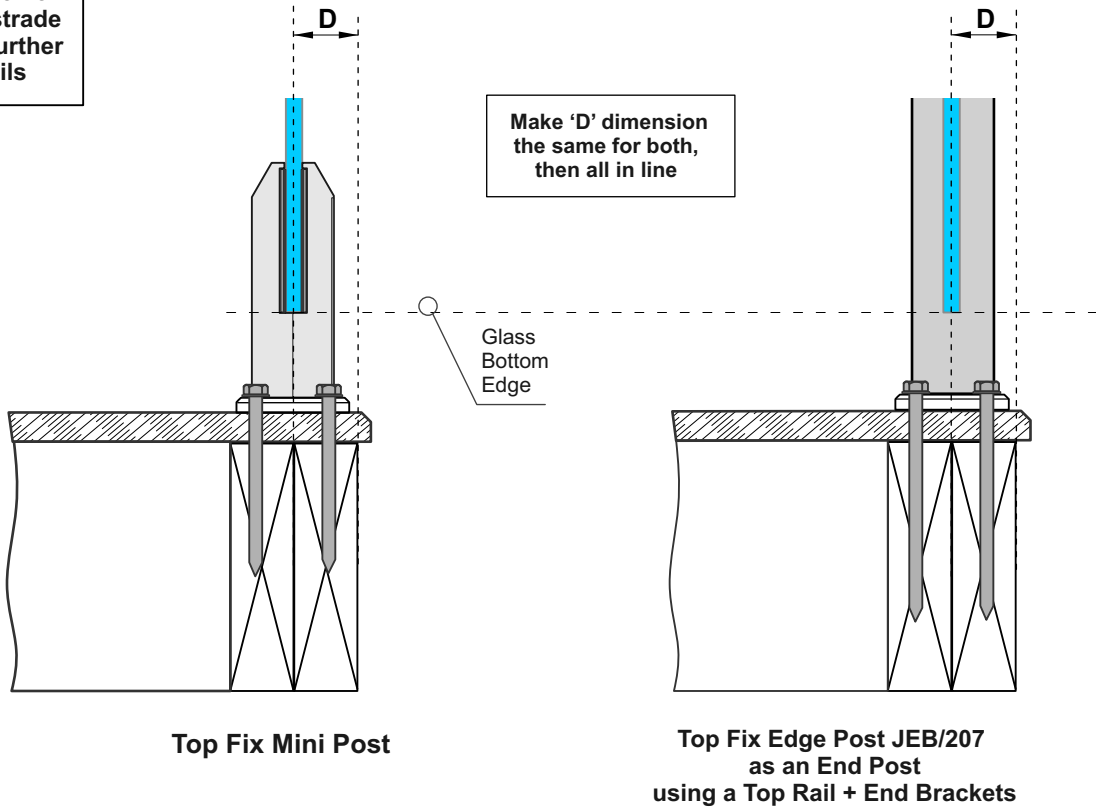

**Interlinking Top Rail for attaching to a Edge balustrade End Post
where Wall fixing not suitable**

Refer to Specific Juralco Balustrade manuals for further fixing details

Glass Panel lines up with Joist edge
D = 0

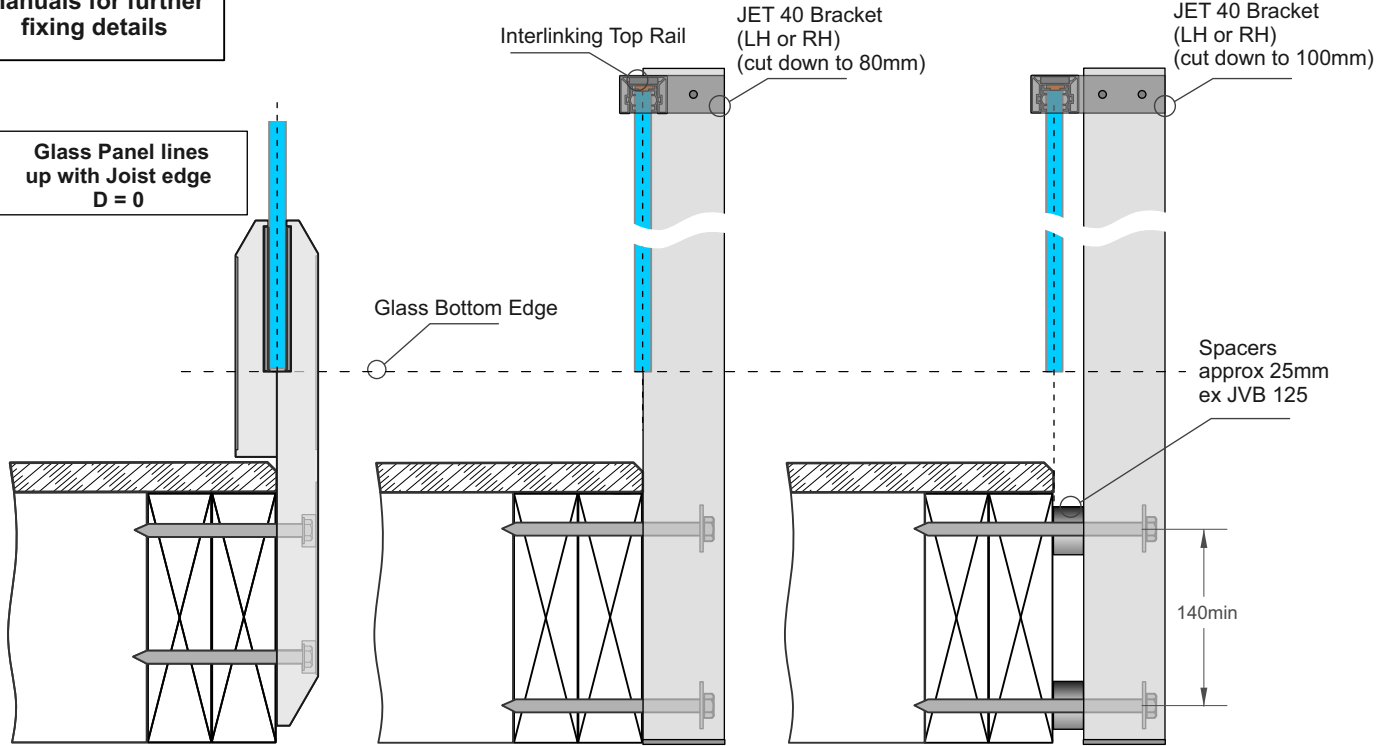

Face Fix Mini Post

**Face Fix Edge Post
as an End post
JEB/208, no Spacer**

**Face Fix Edge Post
as an End post
JEB/208, with Spacer**

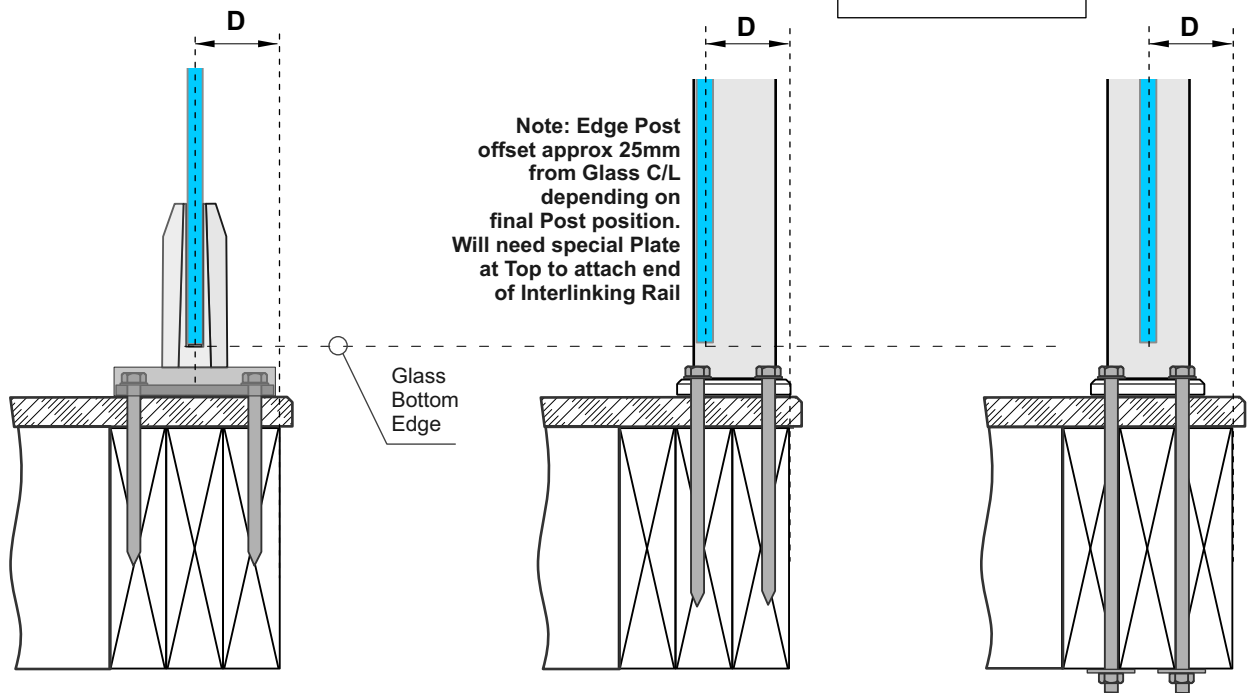

Matador MiniPost

**Top Fix Edge Post JEB/207
as an End Post + Coachscrews
Using a Top Rail + End Brackets**

**Top Fix Edge Post JEB/207
as an End Post + Bolts
Using a Top Rail + End Brackets**

**Interlinking Top Rail for attaching to a Edge balustrade End Post
where Wall fixing not suitable**

Refer to Specific Juralco Balustrade manuals for further fixing details

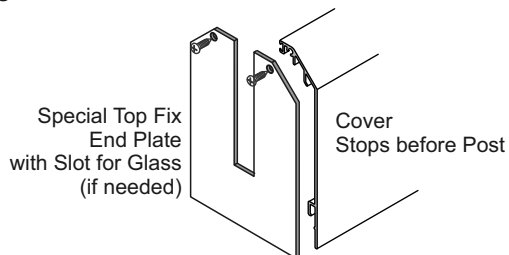
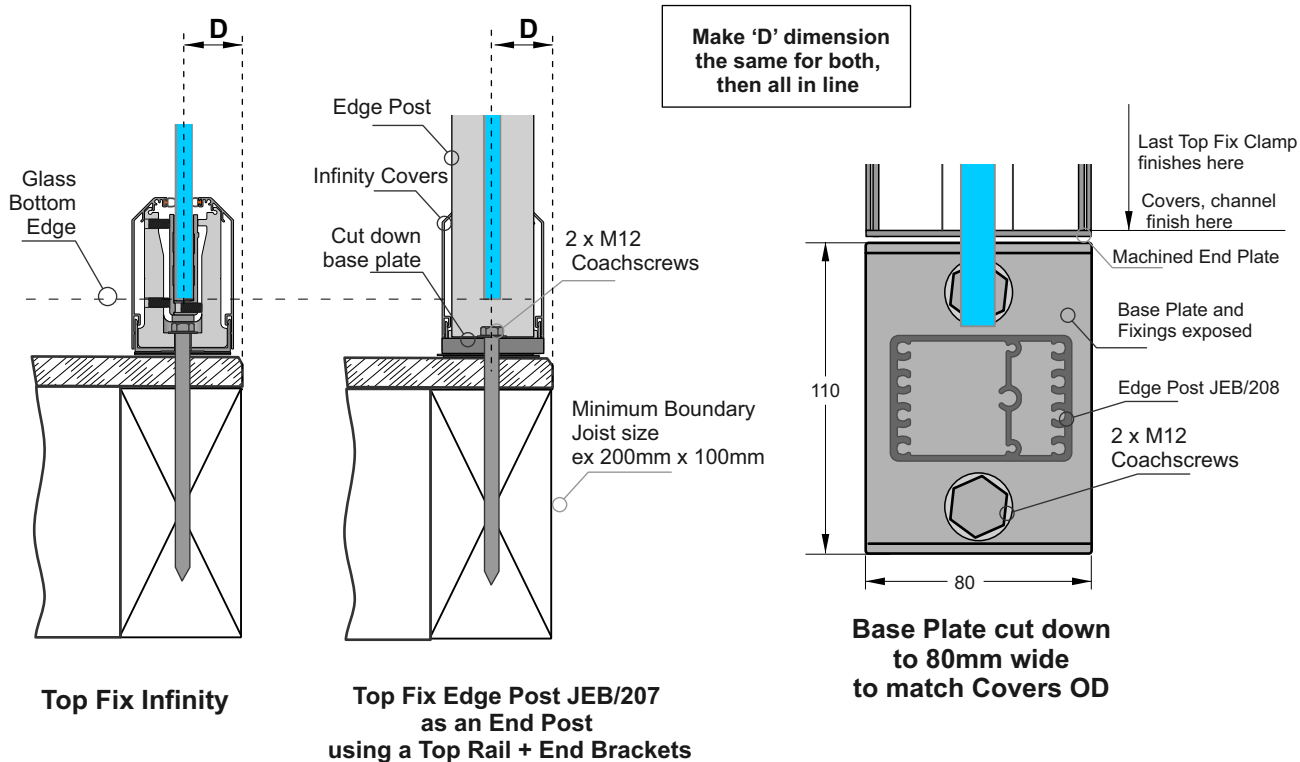
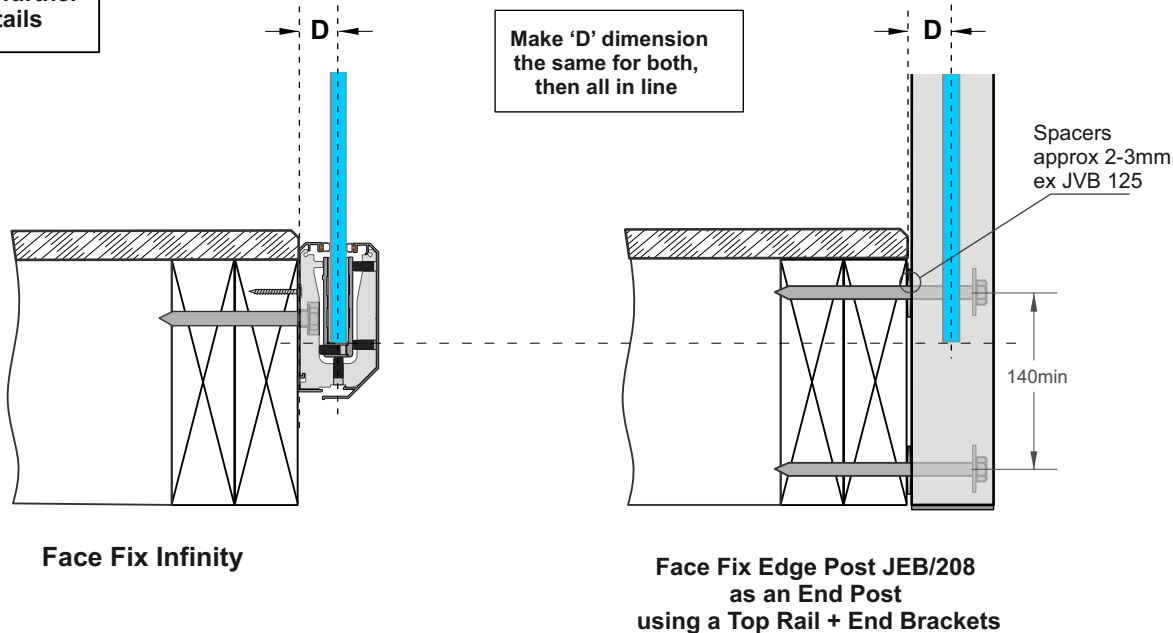

**Interlinking Top Rail for attaching to a Edge balustrade End Post
where Wall fixing not suitable**

Refer to Specific
Juralco Balustrade
manuals for further
fixing details

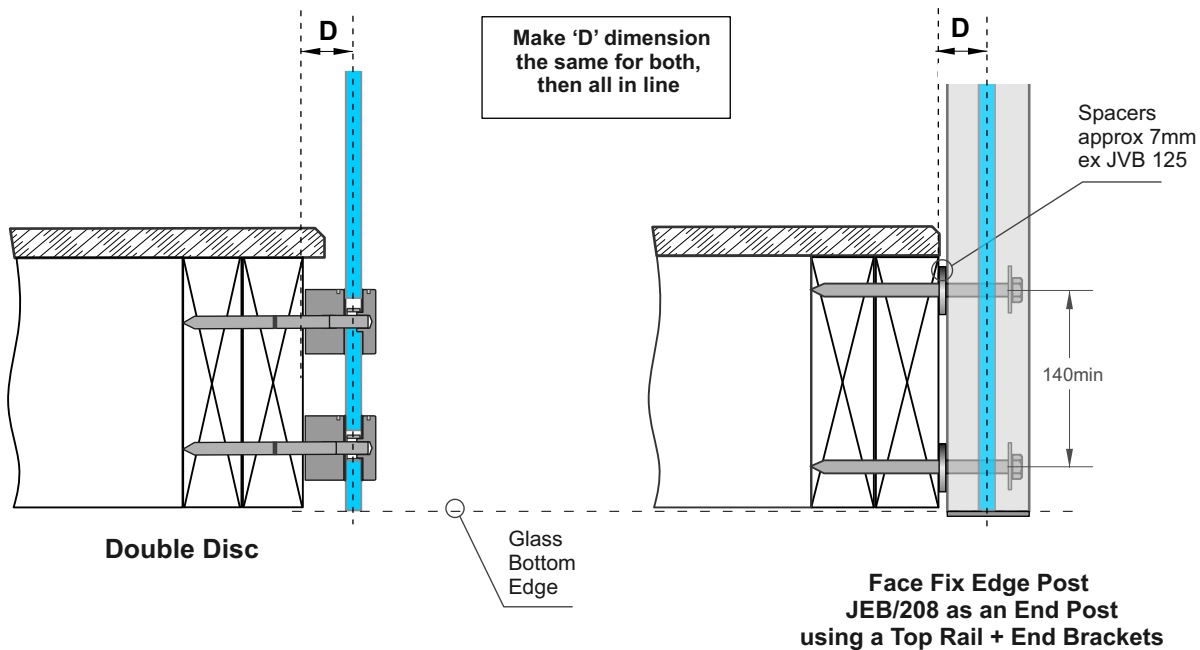
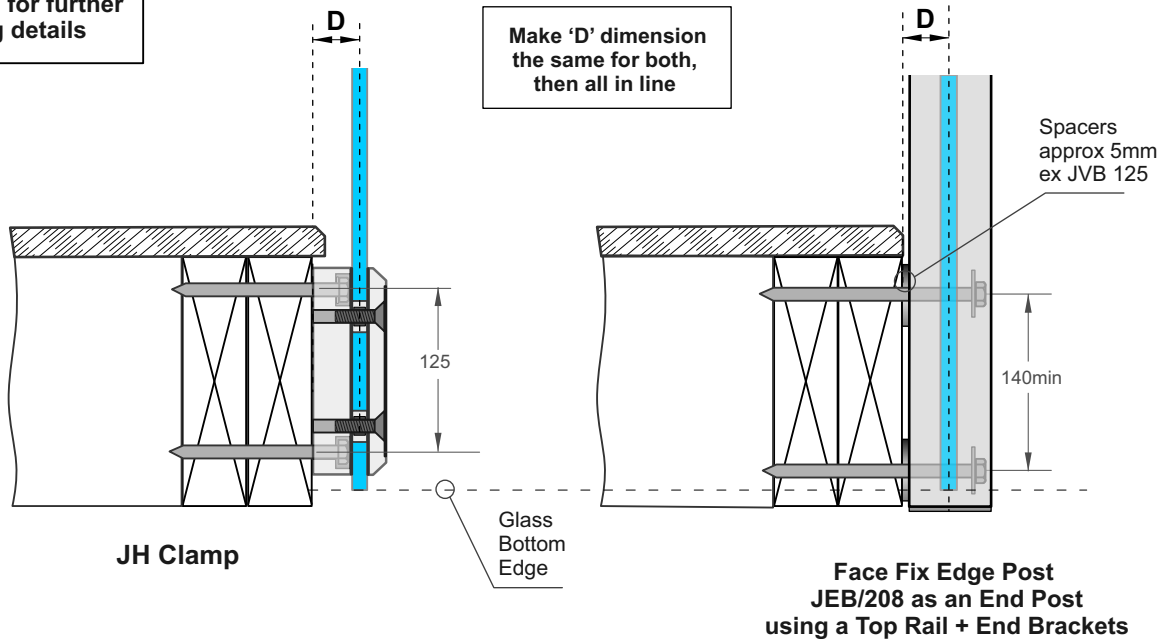

**Interlinking Top Rail for attaching to a Edge balustrade End Post
where Wall fixing not suitable**

Refer to Specific
Juralco Balustrade
manuals for further
fixing details

Make 'D' dimension
the same for both,
then all in line

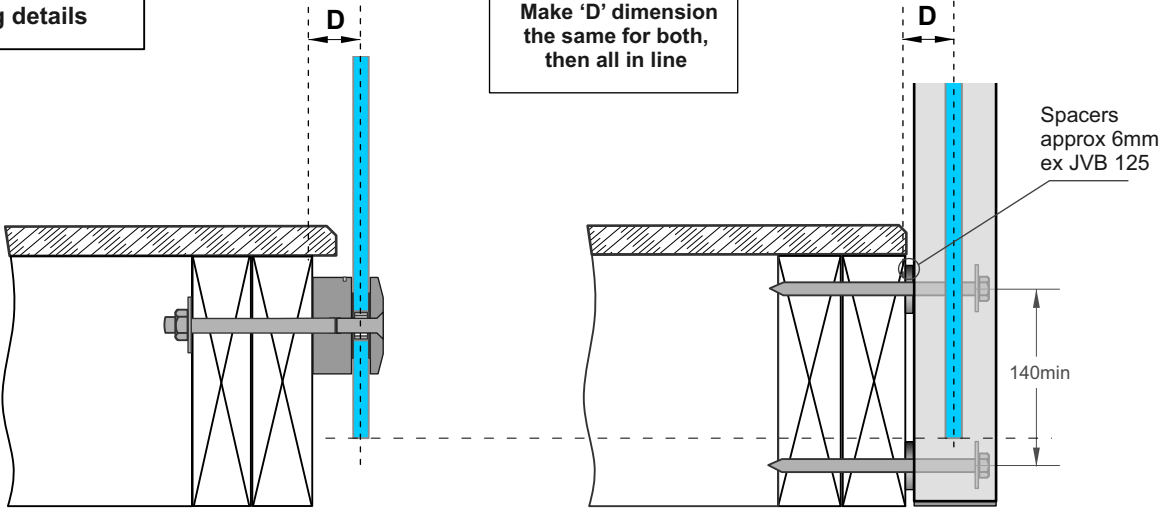

Single Disc

**Face Fix Edge Post JEB/208
as an End Post
using a Top Rail + End Brackets**

Juralco Balustrade Systems - Handrails

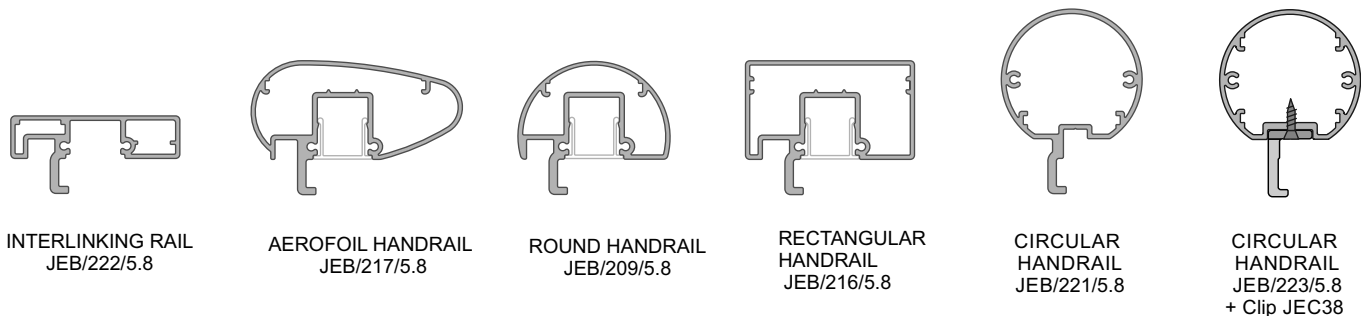

Semi Frameless and Frameless - Handrails on Deck side JEB/222 shown , but any Handrails from above suitable.

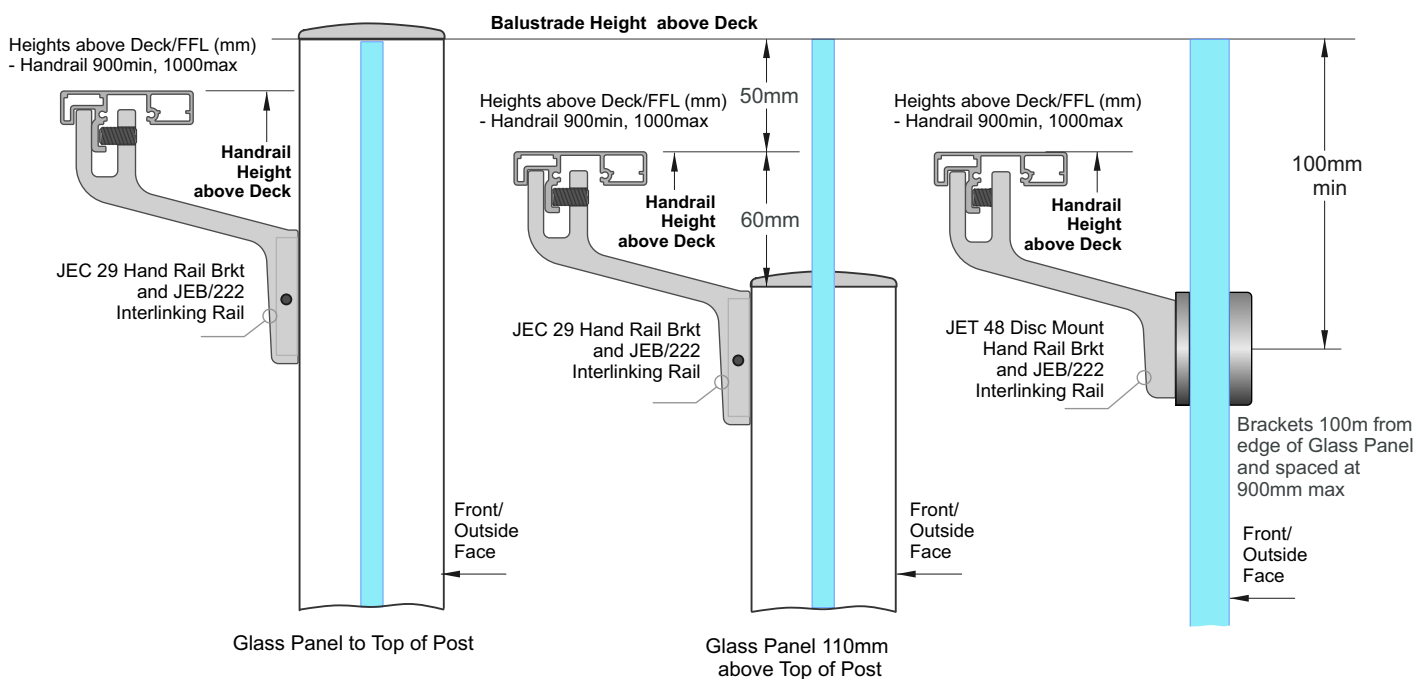

Semi Frameless Glass Systems
EDGE, Viking.
Special END post not required
as the final Post of the Balustrade system
is sufficient

Frameless Glass Systems
Infinity, Double and Single Disc,
MiniPost, Matador Mini Post
and JH Clamp.
END Plates must be used

Important Note: All Interlinking rails, at their ends must be attached to a Building Structure or to an Edge Post attached to the Deck structure, using Rail End Plates/Brackets. Applies to Handrails used as Interlinking Rails

Juralco Handrail End Plates for Attaching to a Structure or Edge Deck mounted Post

End Caps for Handrails, Wall or Edge Post attach for JEB 222, 217, 209, 216 and 221 Handrails

End Caps all ex 3mm Aluminium

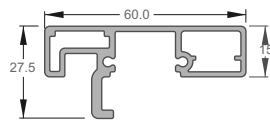

HANDRAIL
Part No JEB/222/5.8

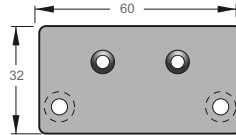

HANDRAIL
WALL ATTACH END PLATE
Part No JEC215/WC

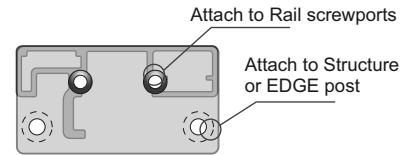

For RH and LH

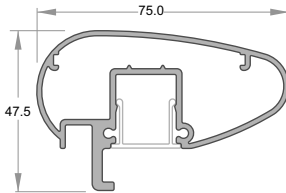

AEROFOIL HANDRAIL
Part No JEB/217/5.8

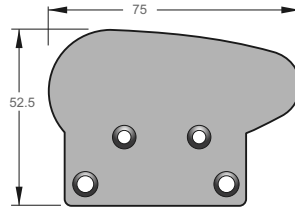

HANDRAIL
WALL ATTACH END PLATE
Part No JEC217/WC

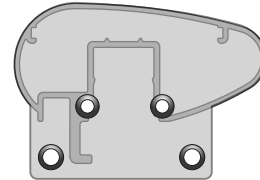

For RH and LH

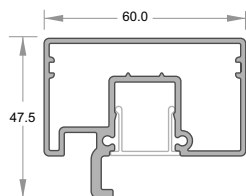

RECTANGULAR
HANDRAIL
Part No JEB/216/5.8

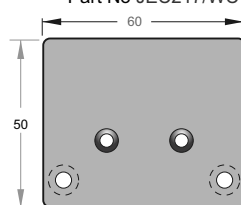

HANDRAIL
WALL ATTACH END PLATE
Part No JEC216/WC

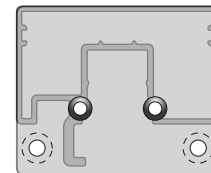

For RH and LH

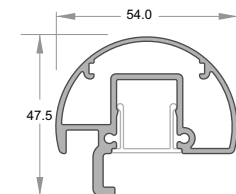

HALF ROUND HANDRAIL
Part No JEB/209/5.8

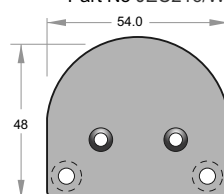

HANDRAIL
WALL ATTACH END PLATE
Part No JEC209/WC

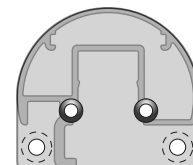

For RH and LH

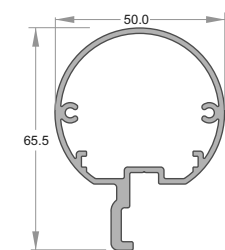

CIRCULAR HANDRAIL
Part No JEB/221/5.8

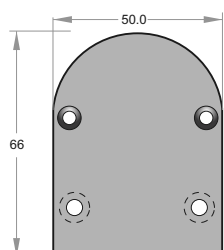

HANDRAIL
WALL ATTACH END PLATE
Part No JEC221/WC

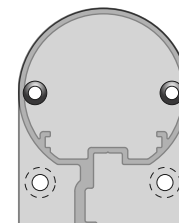

For RH and LH

General Notes: - All fixings to be Stainless Steel. - EPDM layer between Structure and End Cap
- ULS Point load $N^* = 0.9\text{kN}$, inwards, outwards or down and in tension

Note : Fixing to Steel

- use 2 off 8g SS TEK Screws or M6 SS Bolts
- Steel 2mm min thickness
- Steel 300MPa minimum
- 15mm min distance to any Edges

Note : Fixing to Juralco EDGE Post

- use 2 off 8g x 25 SS PK Screws

Note : Fixing to Timber Wall

- use 2 off 8g SS Screws, 35mm min into studs.
- use Sika Supergrip30
- 30mm min distance to Horizontal Edge
- If Weatherboard use suitable predrilled Wedge
- Timber stud wall to be designed and detailed in accordance with NZS3603 or NZS3604

Note : Fixing to Concrete Wall

- use 2 off M6 x70 SS Screw Anchors
- Solid Concrete min 20Mpa
- Block wall Concrete filled/Reinforced
- 140mm min Wall thickness
- 70mm min distance to Horizontal Edge
- 100mm min distance to Vertical Edge
- Blockwork wall must be corefilled /reinforced and is to be designed and detailed in accordance with NZS4230 or NZS4229

Juralco Handrail Components - Joiners

Rectangular Handrails and 75mm Aerofoil - End Cap, Straight and 90deg corners

All ex 3mm Aluminium

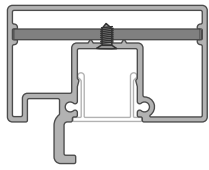

RECTANGULAR HANDRAIL JEB/216/5.8

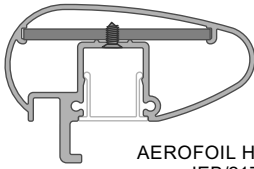

AEROFOIL HANDRAIL JEB/217/5.8

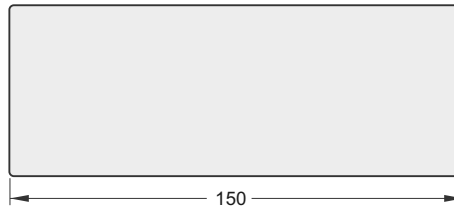

Rectangular and 75m Aerofoil Inline Joiner
Use 56.5 x 3 flat bar JA/189/5.0

Use No6 x 1/4in SS pan sq drive screws, 2 ea side of joint

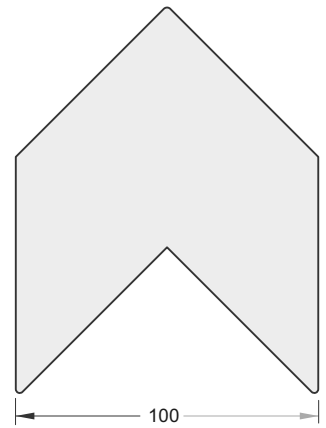

Rectangular and 75m Aerofoil 90deg Corner Joiner JEC 01

Round and Circular Handrail, End Cap, Straight and 90deg corners

All ex 3mm Aluminium

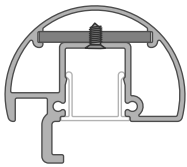

ROUND HANDRAIL JEB/209/5.8

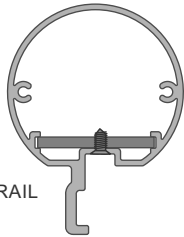

CIRCULAR HANDRAIL JEB/221/5.8

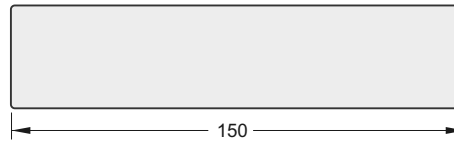

Round and Circular Inline Joiner
Use 34.0 x 3 flat bar JA/188/5.0

Use No6 x 1/4in SS pan sq drive screws, 2 ea side of joint

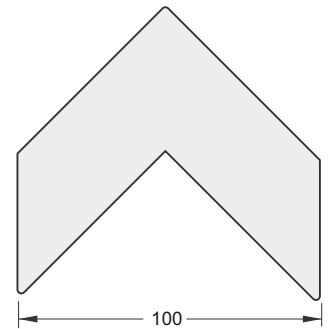

Round and Circular 90deg Corner Joiner JEC 04

Interlinking Rail End Cap, Straight 135 deg and 90deg corners

All ex 3mm Aluminium

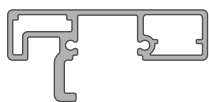

STANDARD HANDRAIL JEB/222/5.8

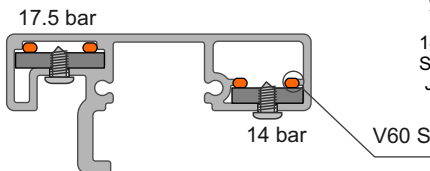

Joiners:

- With Joiner in place, spot drill from below for position
- Drill out joiner to 3mm dia, extrusion to 4mm dia
- Use No 6 x 1/4in SS ST Pan sq drive screw
- Insert V60 Silicone inside cavities before inserting
- Both ends to be attached.
- Joins must be within 300mm of Post
- Minimum distance between screw and end of handrail is 10mm

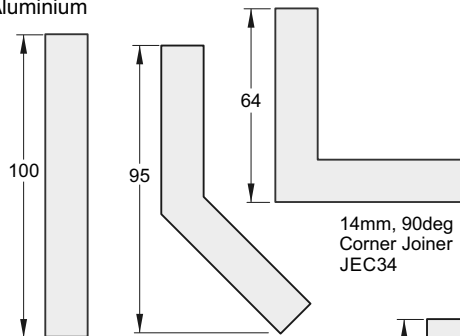

14mm Straight Joiner JEC32

14mm, 135deg Corner Joiner JEC36

14mm, 90deg Corner Joiner JEC34

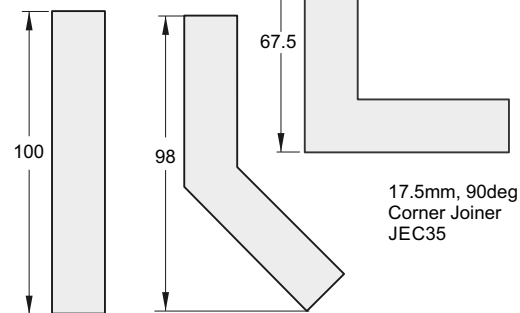

17.5mm Straight Joiner JEC33

17.5mm, 135deg Corner Joiner JEC37

17.5mm, 90deg Corner Joiner JEC35

Juralco Balustrade Systems Powder Coating care

Powder Coating Installation Care

Warning re use of solvents:

- In some cases strong solvents are recommended for thinning various types of paints and also for cleaning up mastics and sealants.
- These can be harmful to the extended life of the powder coated surface, and must not be used for cleaning purposes.
- It is important to note that the damage will not be visible immediately and may take up to 12 months to develop.

If paint splashes or sealants and mastics need to be removed then the following may be safely used:
Methylated Spirits, Ethyl Alcohol, Isopropanol or preferably a mild detergent in warm water.

Joinery Protection during Installation:

All the activity on a construction site means that your powder coated items may get knocked or scratched, splattered with mortar, plaster, textured coating or paint during the later stages of construction.

Please ensure that all powder coated articles are masked or covered at this time. It is far easier to prevent accidents than to try and correct them. Should your joinery receive mortar or paint splashes see that these are removed before cure and follow the instructions contained in this brochure.

Typical sticker used to warn other trades of the need to protect and mask off powder coated joinery (applies to anodised joinery also)

"IMPORTANT ALL TRADES"
This valuable aluminium joinery will suffer permanent damage from: plaster, mortar and paint splashes - Protect if splashes occur - Immediately wash down joinery with water or meths - Do not allow splashes to harden! - Do not use solvents! - Do not remove this label until final clean completed.

This photograph displays damage that has occurred on site, post installation. The photo of the masked joinery displays clear signs of damage that could have occurred were it not masked. Please ensure that your joinery is protected right through the entire construction process.



Powder Coating Maintenance

External - Maintenance Program:

To extend the life of external powder coated articles and to comply with warranty requirements for powder coated aluminium joinery, a simple, regular maintenance program must be implemented.

The effects of ultra violet light, atmospheric pollution, dirt, grime and airborne salt deposits will all accumulate over time and must be removed or surface staining and weathering will occur, leading to an unsightly appearance.

For external coatings, cleaning should take place every six months. In areas where pollutants are more prevalent, such as beachfront houses and industrial or geothermal areas, then a cleaning program should be carried out on a more frequent basis ie. every one to three months.

Fences or Balustrades in close proximity to swimming pools must be washed down every six months, to clean off chlorine and salt deposits.

Cleaning your powder coating:

1. Carefully remove any loose surface deposits with a wet sponge.
2. Use a soft brush (non abrasive) and a mild household detergent (do not use solvents) in warm water, remove dust, salt and other deposits.
3. Rinse off with clean fresh water.



Restoring weathered or scratched surfaces:

Repair of Scuffed or Scratched surfaces
Dulux Spray Cans are available in all colour card colours.

Repair of Small Scratches or Chips.
Dulux Dabsticks are ideally suited for the repair of small scratches.
Dabsticks may not be available in all colour card colours.

Repair of Weathered areas .
Dulux Gloss Up is a light to medium cutting cream ideally suited for gloss restoration and has been specifically designed for this purpose.
Gloss Up contains no waxes or silicone and is a one step system.



Contact Dulux Powder Coatings , ph 0064 9 441 8244

Juralco Balustrade Systems Glass Care and Maintenance

Glass Cleaning and Maintenance

Architectural glass products must be properly cleaned during the construction period so visual and aesthetic clarity are maintained. Because glass can be permanently damaged if improperly cleaned, glass producers and fabricators recommend strict compliance with the following procedures.

First, determine whether the glass is clear, tinted or reflective. Surface damage is more noticeable on reflective glass compared with the other glass products. If the reflective coated surface is exposed, either on the exterior or interior, special care must be taken when cleaning, as scratches can result in coating removal and a visible change in light transmittance. Cleaning tinted and reflective glass in direct sunlight should be avoided. Cleaning should begin at the top of the building and continue to the lower levels.

Commence cleaning by soaking the glass surfaces with clean water and a soap solution to loosen dirt or debris. Then, using a mild, non-abrasive commercial window washing solution, uniformly apply the solution to the glass surfaces with a non-abrasive applicator and follow with a squeegee to remove all of the cleaning solution from the glass surface.

Ensure that no metal parts of the cleaning equipment touch the glass surface and that no abrasive particles are trapped between the glass and the cleaning materials. All water and cleaning solution residue should be dried from the window gaskets, sealants and frames.

Scratches and Metal Scrapers

Scratches can occur from hard pointed objects or poor handling, but most often occurs from the careless removal of foreign matter from the glass surface.

Mortar splatter and paint are common offenders and efforts to remove after hardening almost always lead to surface damage. It is essential that the foreign materials are removed before they harden. Better still, if construction work continues after glazing, that the glazed areas are protected by adhesive plastic films or suitable tarpaulins or covers.

One of the common mistakes made by non-glass trades people, including glass cleaning contractors, is the use of razor blades or other metal scrapers on a large portion of the glass surface. Using large blades to scrape a window clean carries considerable risk of causing damage to the glass.

The glass industry, fabricators, distributors and installers neither condones nor recommends any scraping of glass surfaces with metal blades or knives. Such scraping usually permanently damages or scratches the glass surfaces. When paint or other construction materials cannot be removed with normal cleaning procedures, a new 25mm razor blade may have to be used. The razor blade should be used on small spots only. Cleaning should be done in one direction only. Never scrape in a back and forth motion as this could trap particles under the blade that could scratch the glass.

Blades or scrapers can dislodge "pickup" on toughened glass. There are fine particles of glass that are fused on to the surface during toughening. Once dislodged they can scratch the glass.

Glass Cleaning, Do's and Don'ts

DO NOT..

- Do Not - Use Scrapers of any type or size on a Glass surface
- Do Not - Leave building dirt or residues to remain on Glass for a period of time.
- Do Not - Begin cleaning glass until you have identified the surface type.
- Do Not - Clean Glass surfaces in direct sunlight.
- Do Not - Allow dirty water or cleaning residues to remain on the Glass.
- Do Not - Begin cleaning before rinsing off a loose residues.
- Do Not - Use abrasive cleaning solutions, materials or solvents.
- Do Not - Allow metal parts of the cleaning equipment to come in contact with the Glass.
- Do Not - Trap abrasive particles between the cleaning material and the Glass.

DO...

- Clean glass promptly when dirt or building residues appear.
- Determine glass surface type.
- Exercise special care when cleaning coated surfaces.
- Avoid cleaning glass surfaces in direct sunlight.
- Start cleaning at the top of a building, then continue to lower levels.
- Soak the glass surface in a clean soapy solution before cleaning.
- Use a mild non abrasive commercial cleaner.
- Use a squeegee to remove all cleaning solution.
- Try your procedures on a small window and check.
- Caution other trades re the care and protection of the glass surfaces.

**Residues of surface grit may be present from the toughening production process.
These grit particles must not be dragged across the surface.
NEVER use Metal Scrapers**

All above reprinted with permission from Metro Glass Tech

Juralco Balustrade Systems

Stainless Steel care

Care and Maintenance of Stainless Steel

Introduction

Stainless steels are selected for applications where their inherent corrosion resistance, strength and aesthetic appeal are required. However, dependent on the service conditions, stainless steels will stain and discolour due to surface deposits and so cannot be assumed to be completely maintenance-free. In order to achieve maximum corrosion resistance and aesthetic appeal, the surface of the stainless steel must be kept clean. Provided the grade of stainless steel and the surface finish are correctly selected, and cleaning schedules carried out on a regular basis, good performance and long service life will result.

For the correct selection of a Stainless Steel grade, with respect to Location, see Table below.

Factors affecting maintenance

Surface contamination and the formation of deposits on the surface of the stainless steel must be prevented. These deposits may be minute particles of iron or rust generated during construction. Industrial and even naturally occurring atmospheric conditions can produce deposits which can be equally corrosive, e.g. salt deposits from marine conditions.

Working environments can also provide aggressive conditions such as heat and humidity in swimming pool buildings. These conditions can result in surface discolouration of stainless steels and so maintenance on a more frequent basis may be required.

Modern processes use many cleaners, sterilizers and bleaches for hygienic purposes. Proprietary solutions, when used in accordance with makers' instructions, should be safe but if used incorrectly (e.g. warm or concentrated), may cause discolouration or corrosion on stainless steels. Strong acid solutions are sometimes used to clean masonry and tiling of buildings. These acids should never be used where contact with metals, including stainless steel, is possible. If this happens, the acid solution must be removed immediately, followed by dilution and rinsing with clean water.

Maintenance programme

With care taken during fabrication and installation, cleaning before 'hand-over' should not present any problems. More attention may be required if the installation period has been prolonged or hand-over delayed. Where surface contamination is suspected, immediate cleaning after site fixing should avoid problems later.

The frequency of cleaning is dependent on the application. This may vary from once to four times a year for external applications, Recommendations on cleaning frequencies in architectural applications are shown below.

Cleaning frequency

Reccommended Cleaning for various grades of Stainless Steel		
Location	304 Grade	316 Grade
Surbarban or Rural	Clean at 6-12mth intervals or as necessary	
Industrial or Urban	Clean at 3-6mth intervals	Clean at 6-12mth intervals
Coastal or Marine	Not recommended	