



990 C

Combination Lock

Legge's 990 C Combination Mortice Lock has been designed specifically to meet the requirements of the Australasian market. The 990 C is ideally suited for commercial, industrial, institutional and government buildings, where durability and security are of major importance.

The 990 C has a high purity die cast zinc alloy case to provide rigidity and precision. Major internal components are made of either stainless steel or sintered steel/copper alloy to provide durability and strength.



Features

- Multi-function case allows easy conversion of a vestibule lock function (inside handle free) to a combination lock function (both handles locked) by a simple external operation
- Reversible stainless steel latch adjusts for inwards/outwards opening and left/right hand without case disassembly
- Standard lock suitable for doors 32mm to 50mm thick. Extended cylinders, spindles and strike plates available to accommodate thicker doors and wider jambs
- 990MF case will accept bolt-through fixing for 50.8mm diagonal and 38mm-41mm horizontal fixing door furniture
- Follower will accept 7.6mm-8mm furniture spindles, with no adjustment necessary
- A threaded pin is used for secure cylinder retention
- Designed to be compatible with FES20M and FES90M-P electric strikes

Warranties	
Mechanical	30 years
Finish	allegion.co.nz/finisheswarranty

Specification guide

Function	Sub-function	Finish	Backset
Combination lock.....L9C	Entry lock.....C1	Antique Bronze.....ABZ	60mm.....refer to 991
	Sliding door lock.....C7	Chrome Plate.....CP	70mm.....70
	Entry lock.....C21	Oil Rubbed Bronze.....ORB	89mm.....89
	Turn entry lock.....C23	Polished Brass.....PB	127mm.....127
	Double cylinder lock.....C27	SatinBlackChrome.....SBC	
	Single cylinder lock.....C31	Satin Brass.....SB	
	Privacy latch.....C33	Satin Black Unlacquered.....SBU	
	Passage latch.....C57	Satin Chrome Plate.....SCP	

- Function**
Select the desired function e.g., Combination door lock L9C
- Sub-function**
Select the required sub-function e.g., C1 Combination door lock L9C1
- Finish**
Select the desired finish e.g., Satin chrome plate L9C1S

Finishes



Legge 990 C Combination Lock

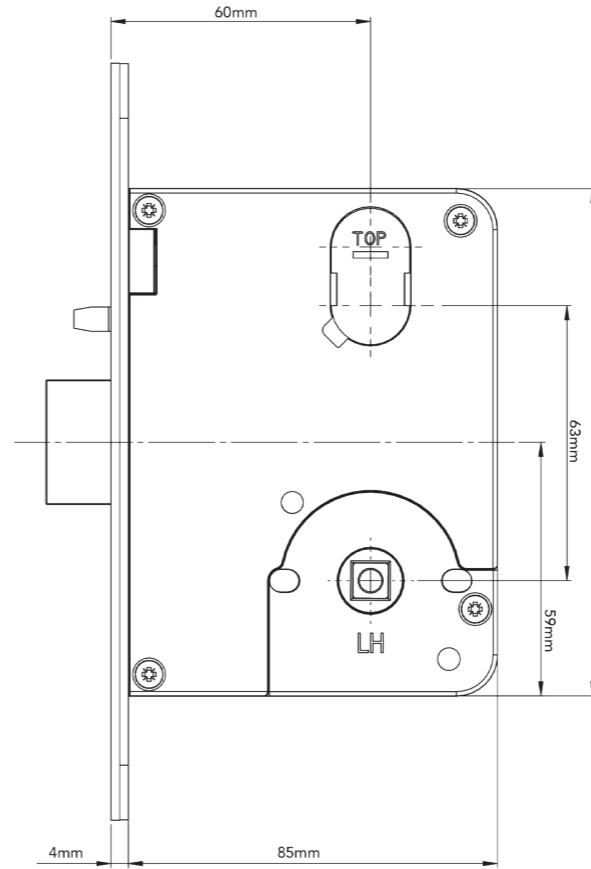

- Key or turn locks or unlocks both handles simultaneously
- Deadlatching engages when door is in closed position
- Reversible bolt for handing

Specifications	
Door type	Timber or metal
Door thickness	32mm to 50mm standard, extended cylinders, spindles and strike plates available to accommodate thicker doors
Lock case	High purity zinc alloy
Outer forend	Stainless steel or brass
Inner forend	Stainless steel
Bolt	Stainless steel
Sub-bolt	Stainless steel
Spindles	2 split spindles 32mm
Strike plate	Stainless steel or brass 45mm standard. 40mm, 50mm, 60mm, 70mm, 80mm & 90mm available
Backsets	60mm (refer to Legge 991), 70mm, 89mm and 127mm available
Key cylinder	C4 6 Pin keyway standard, Schlage C6 pin keyway optional, Schlage SR1 Restricted keyway optional, Schlage Everest Open & Restricted keyways optional

Testing and Compliance

- Security:**
Rated S8 and SL8 for physical security, SC7-SC8 for cylinder security and K6 for keying security
- Corrosion:**
Rated C7 for corrosion
- Durability:**
Rated D8 for durability

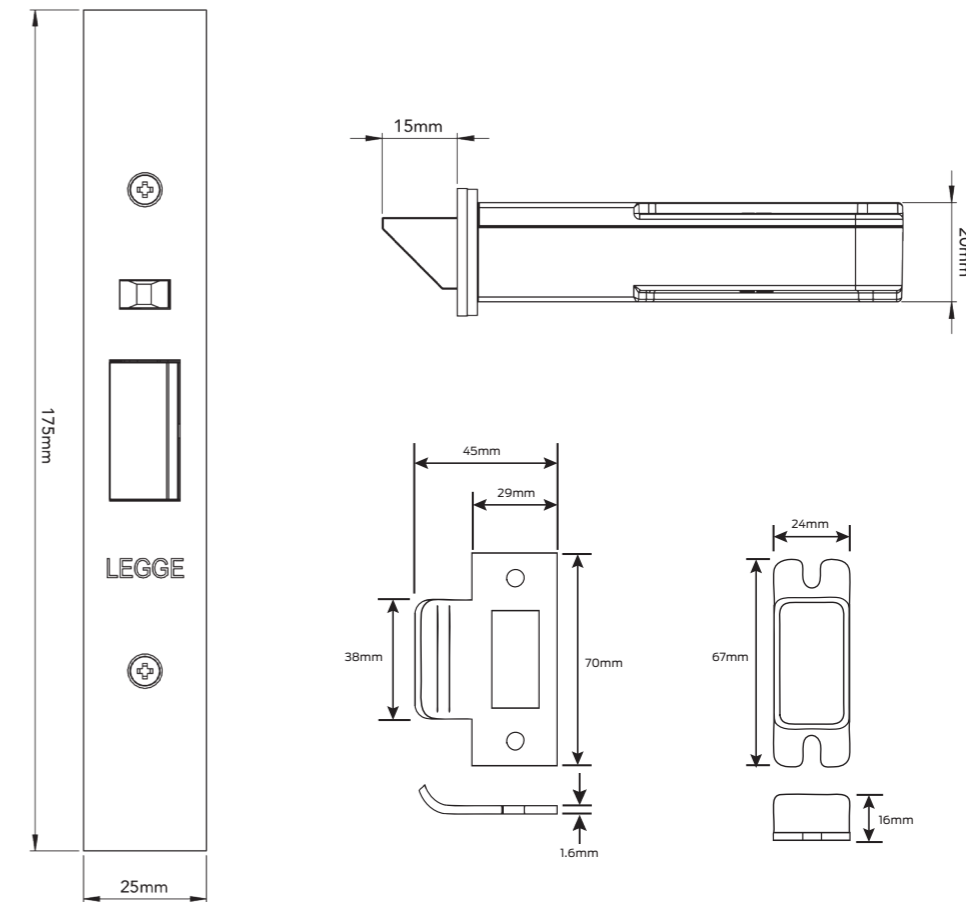

Legge 990 C Combination Lock

Sub-function

Cams and adaptors

C1 - Entry lock (singles entry)

Outside: Key operates bolt at all times. Both handles operative except when locked by inside turn
 Inside: Turn locks and unlocks both handles

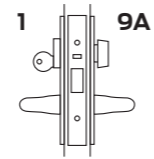

C7 - Shopfront door lock

Outside: Key operates bolt at all times. Both handles operative except when locked by inside key
 Inside: Key locks and unlocks both handles

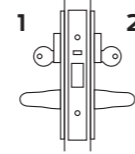

C21 - Entry lock

Outside: Both handles operative except when locked by outside key or inside turn
 Inside: Turn locks and unlocks both handles

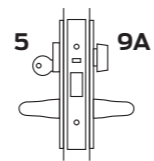

C23 - Turn entry lock

Outside: Both handles operative except when locked by outside key
 Inside: Turn operates bolt at all times

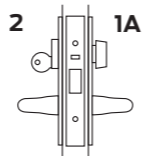

C27 - Double cylinder lock

Outside: Handle operative except when locked by outside or inside key
 Inside: Handle operative except when locked by inside or outside key

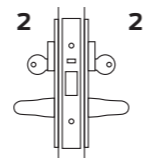

Legge 990 C Combination Lock

Sub-function

Cams and adaptors

C31 - Single cylinder lock

Outside: Both handles operative except when locked by outside key
 Inside: Handle operative except when locked by outside key

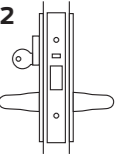

C33 - Privacy latch

Outside: Operative except when locked by inside turn. Emergency button unlocks both handles
 Inside: Turn locks and unlocks both handles

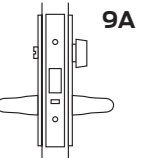

C57 - Passage latch

Outside: Always operative
 Inside: Always operative

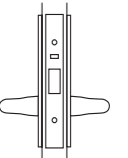

Legge 990 C Cams and Cam Adaptors

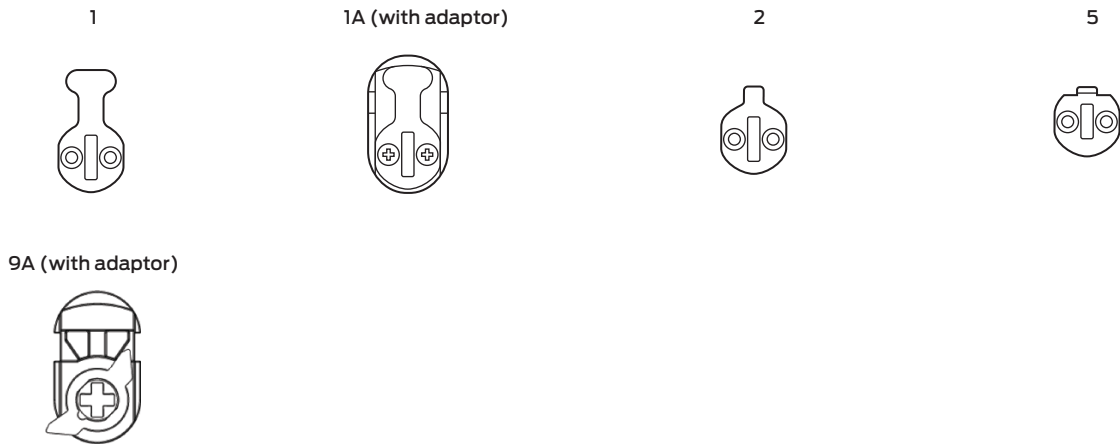

Legge 990MF Series accessories

R13 Rebate kit

This kit adapts latches and strikes for 13mm rebated door preparations

Finishes: Satin Stainless Steel or for special finishes available, refer to page 2

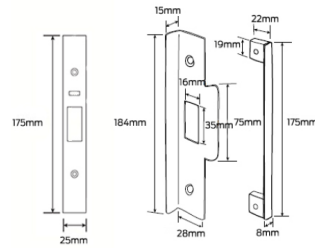

Non-standard strikes

Component Variants		
Description	A	B
LL40 Ext Striker	40	32
LL50 Ext Striker	50	42
LL60 Ext Striker	60	52
LL70 Ext Striker	70	62
LL80 Ext Striker	80	72
LL90 Ext Striker	90	82

