

Vista™ Installation Guide

*Applicable to all Vista Panel shapes

MATRIX BAFFLES

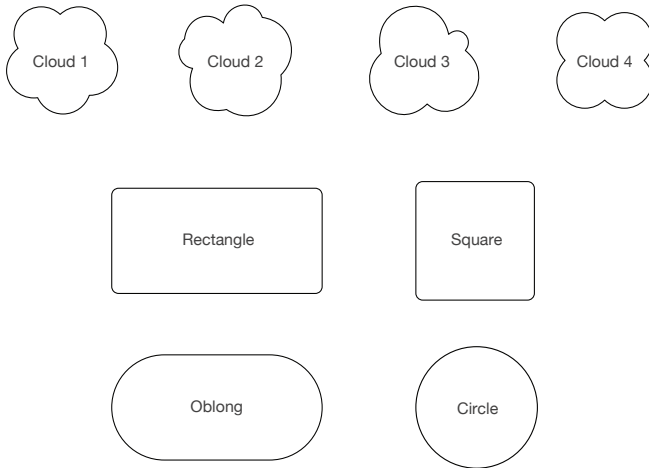

SUSPENDED FIX

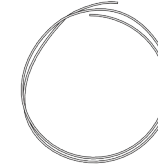
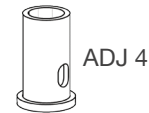

WIRE
1200 mm standard

SCREWS

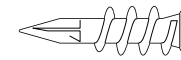

NOT INCLUDED

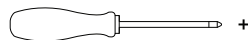

Phillips

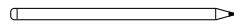

Pencil



Measuring tape



Laser



2 x person
assembly
recommended



2 x ladder
recommended

Vista™ Installation Guide

*Applicable to all Vista Panel shapes

1 LASER METHOD

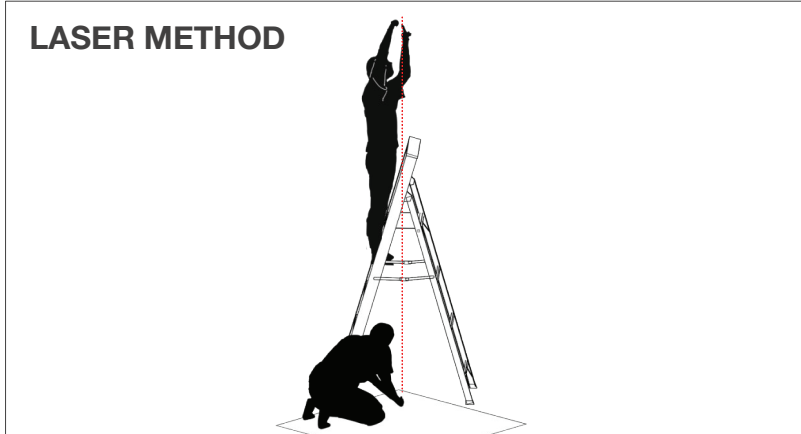

Lay supplied stencil on ground directly below ceiling surface you would like to install your Vista panel. Point laser vertically on each marked spot on the stencil while the second person marks the laser spots on the ceiling using a ladder. Apply this method to each attachment spot.

MANUAL METHOD

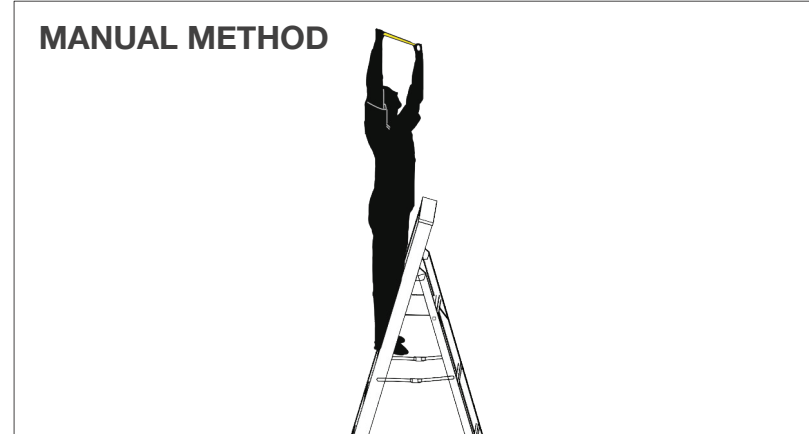

Hold stencil to ceiling, marking all fitment locations on ceiling. If unable to use stencil, use measurements marked on stencil and manually measure and transfer markings.

2

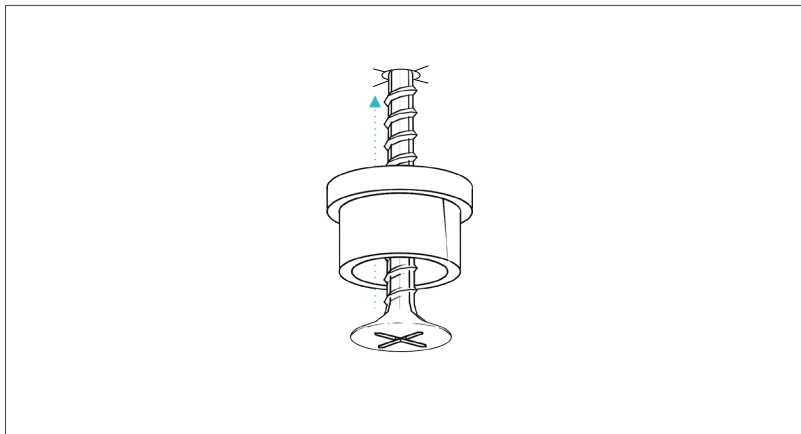

Hold stencil to ceiling, marking all fitment locations on ceiling. If unable to use stencil, use measurements marked on stencil and manually measure and transfer markings.



Vista™ Installation Guide

*Applicable to all Vista Panel shapes

3

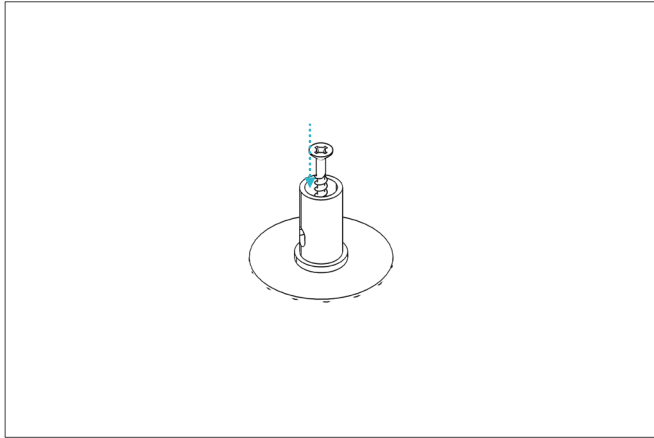

Screw adjustment 4 to base, rear of panel, until fixed tightly.

3a

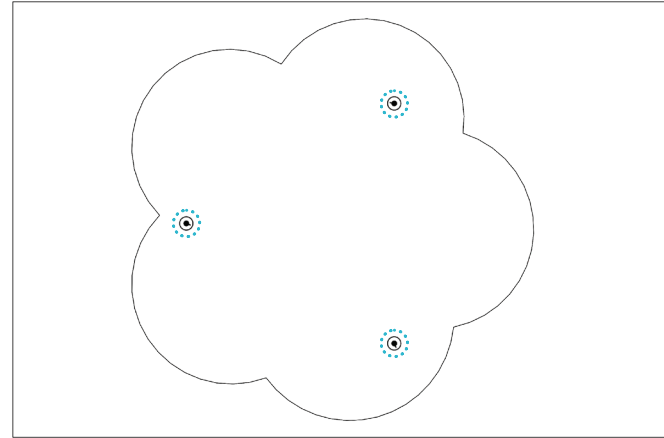

Apply this to all fitment spots.

4

HOT TIP!
To extend, pull metal gizmo with finger nail to release wire

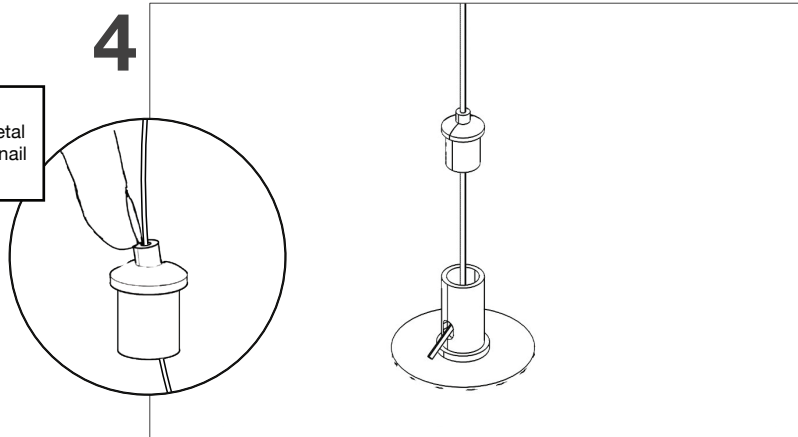

Thread wire a few inches through Adjustment 3. Insert wire through adjustment 4. Screw both adjustments until tight.

4a

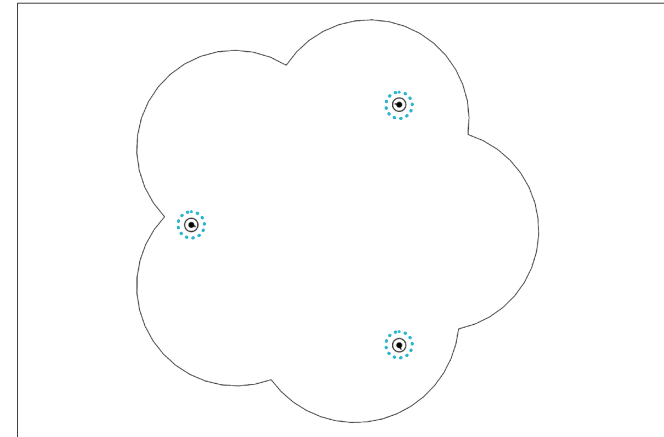

Apply this to all fitment spots. Adjust all wires to the desired height using accurate measuring*

*Recommended distance from ceiling: 250mm



Vista™ Installation Guide

*Applicable to all Vista Panel shapes

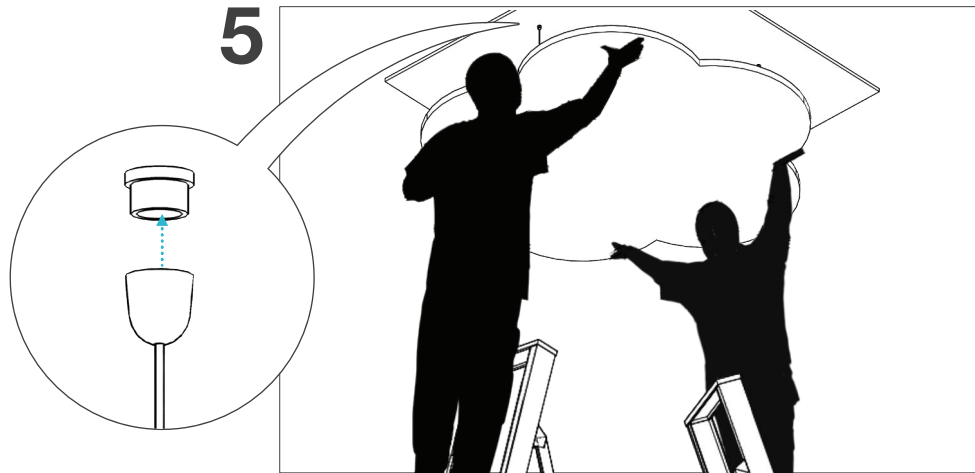

Using responsible safety measures, lift to designated spot using two people.

Screw all of adjustment 4 into all of adjustment 3 to ceiling.

Attach opposite corners first then move on to the rest.

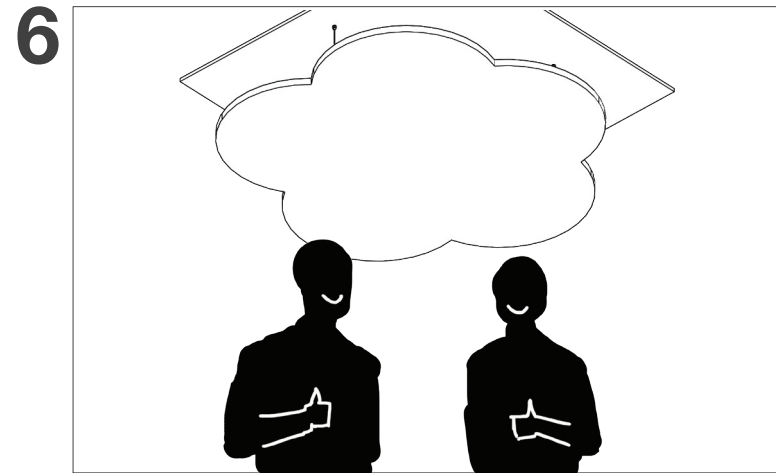

Adjust wire length if needed. Enjoy your finished Vista Panel!

