

**80MM SHOPFRONT
F080SF MAGNUM 50 HINGED DOOR**

CROSS SECTION

Date 01.11.09 Scale 1:2

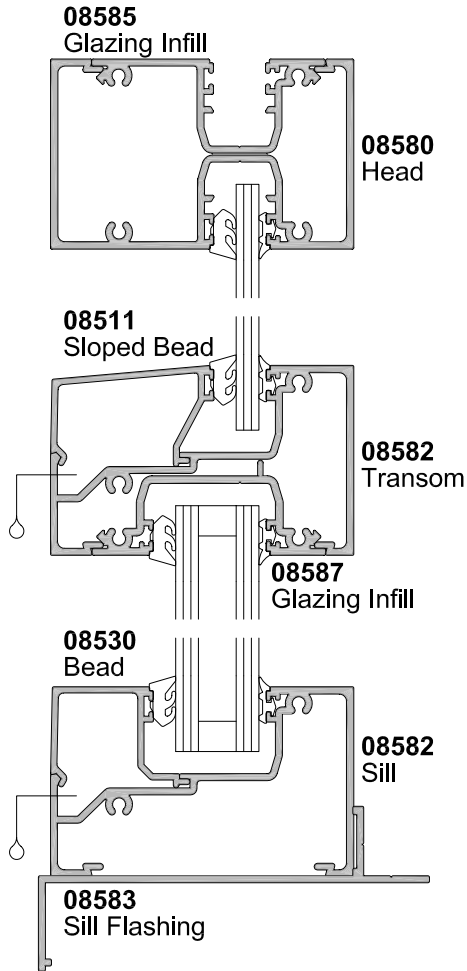

SECTION A-A

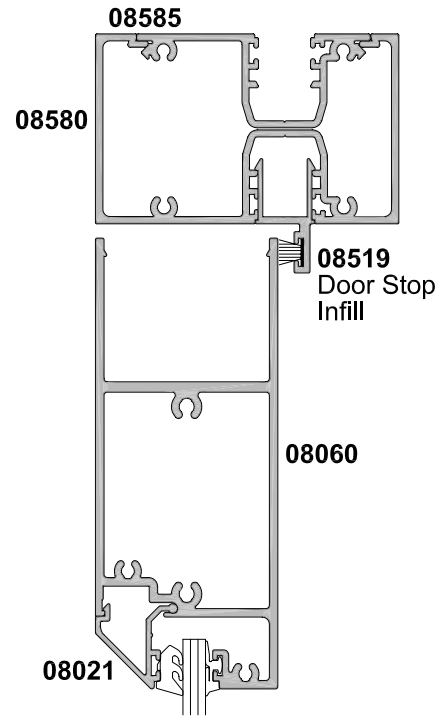

SECTION C-C

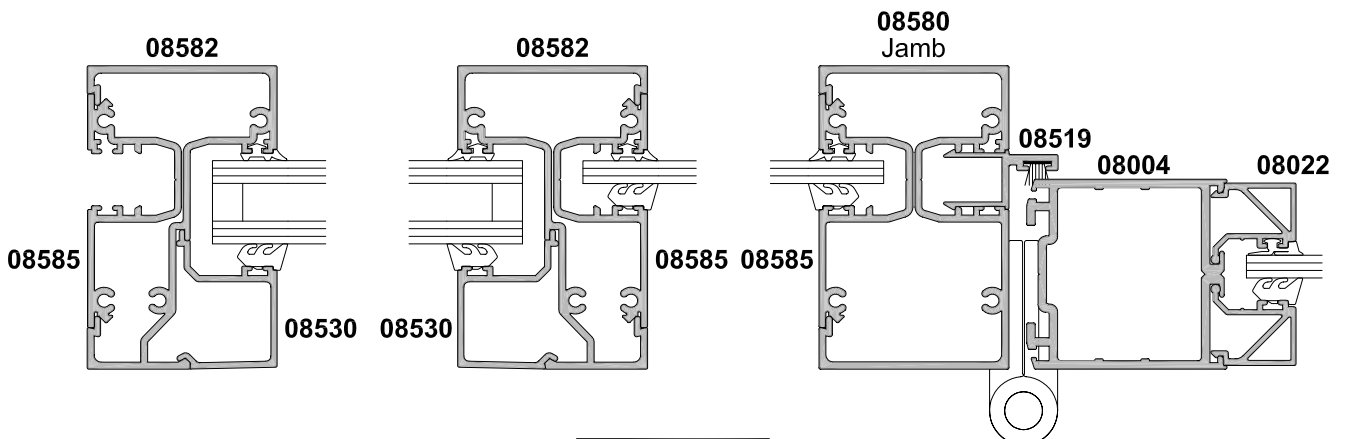

SECTION B-B



Cad Ref. FCSF03-0

80MM SHOPFRONT F080SF 40MM AWNING WINDOW AND MAGNUM 50 PIVOT DOOR

CROSS SECTION

Date 01.11.09 Scale 1:2

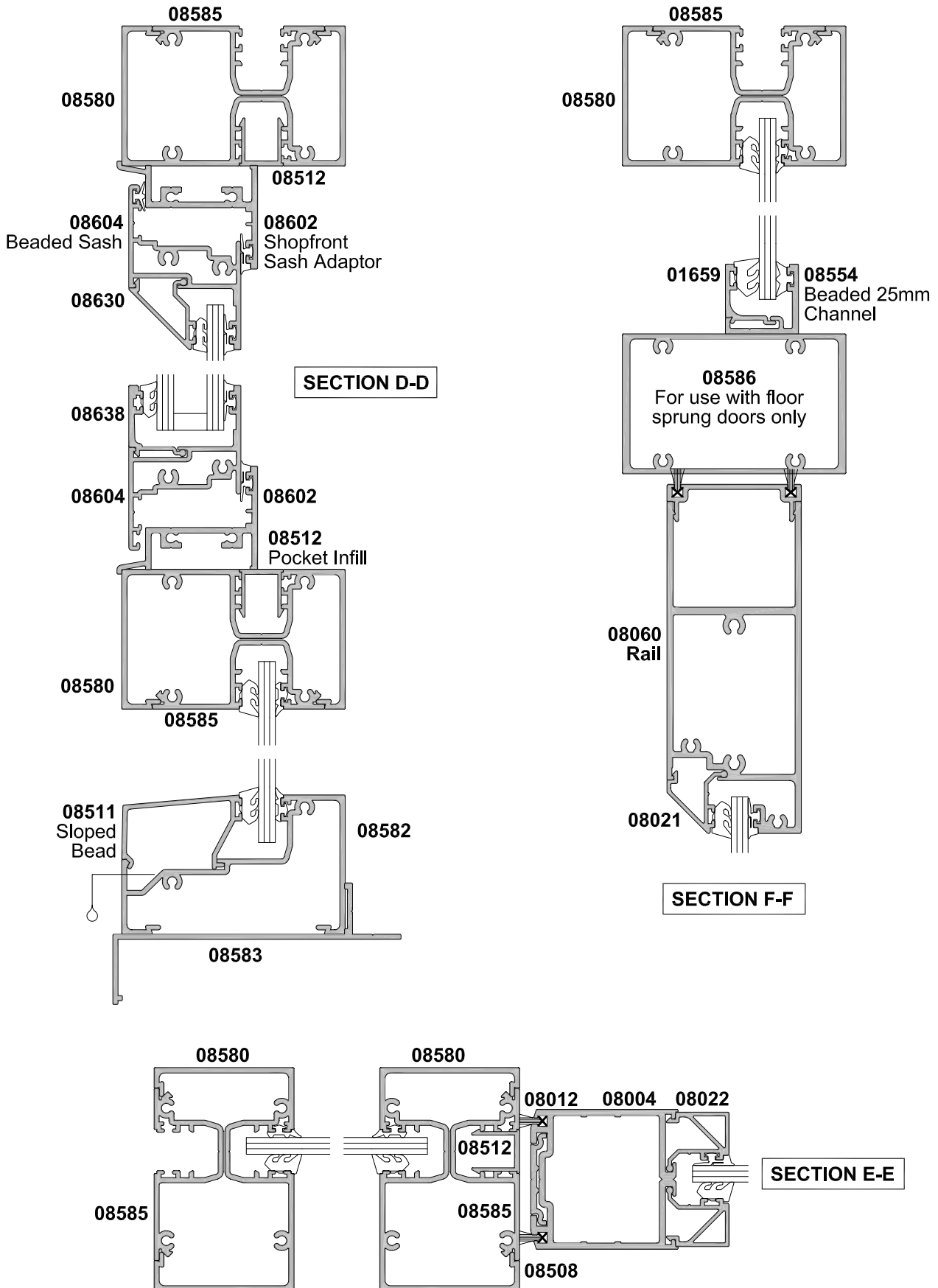

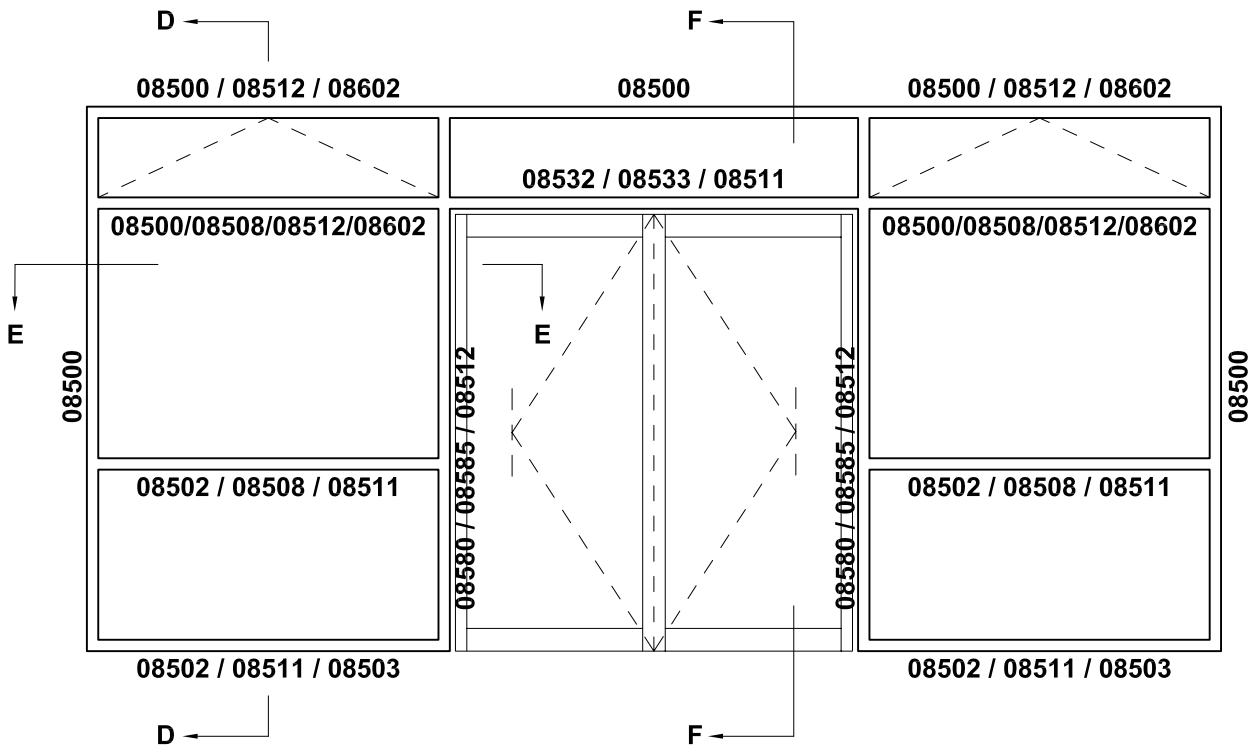
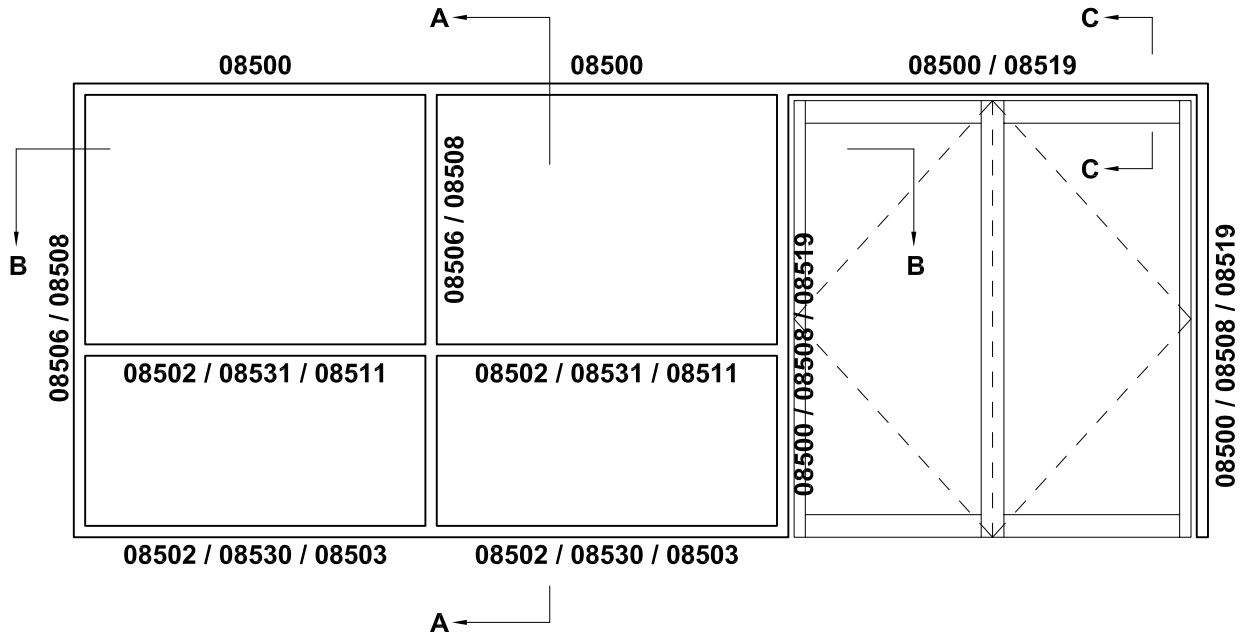

**100MM SHOPFRONT
F100SF MAGNUM 50 HINGED DOOR**

CROSS SECTION

Date 01.11.09 Scale 1:2

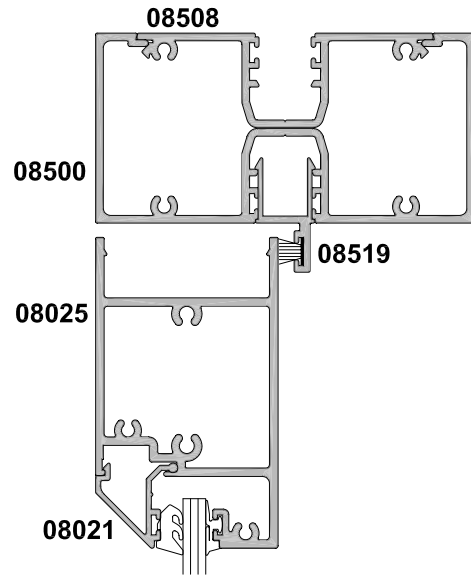
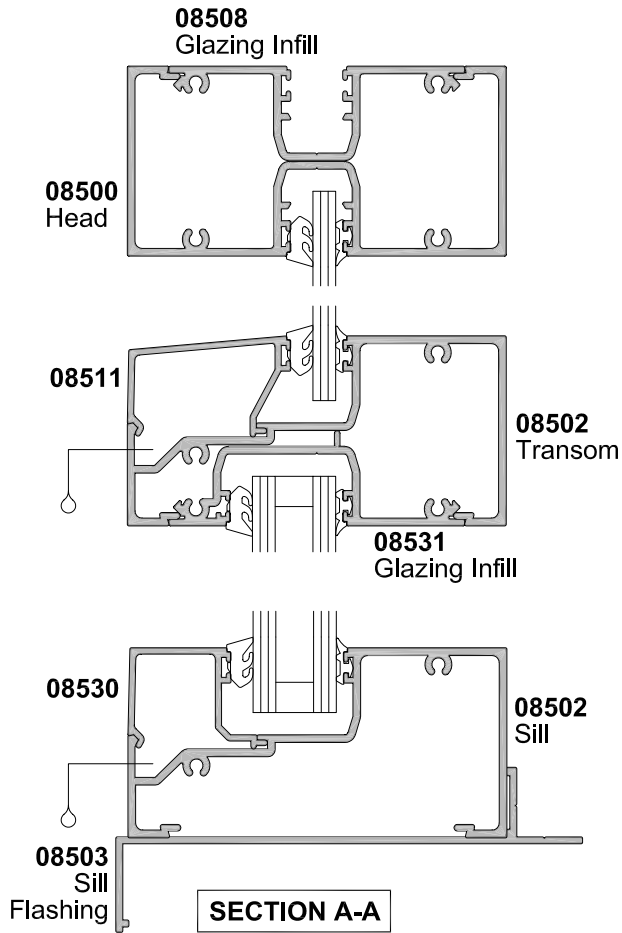

SECTION C-C

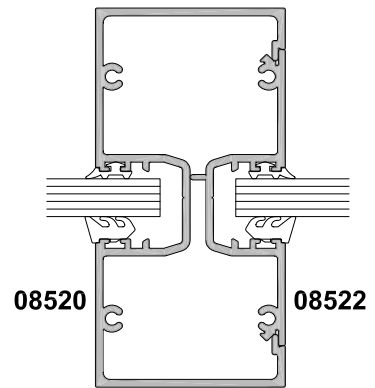

18mm POCKET OPTION

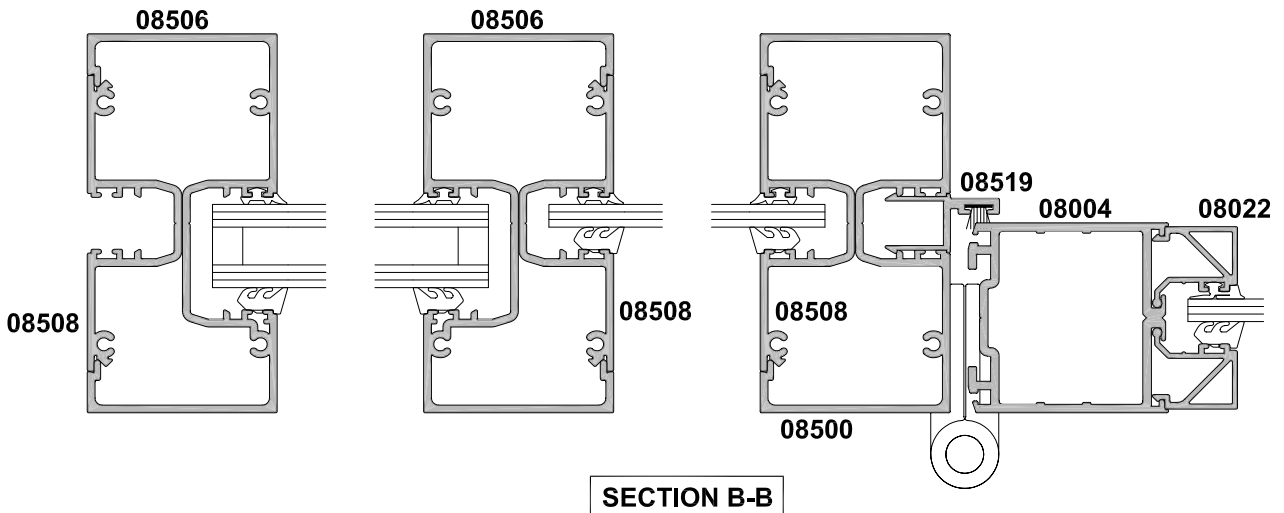

**100MM SHOPFRONT
F100SF 40MM AWNING WINDOW
AND MAGNUM 50 PIVOT DOOR**

CROSS SECTION

Date 01.11.09 Scale 1:2

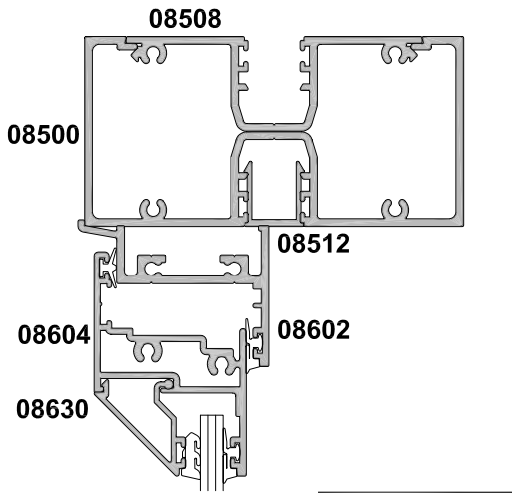

SECTION D-D

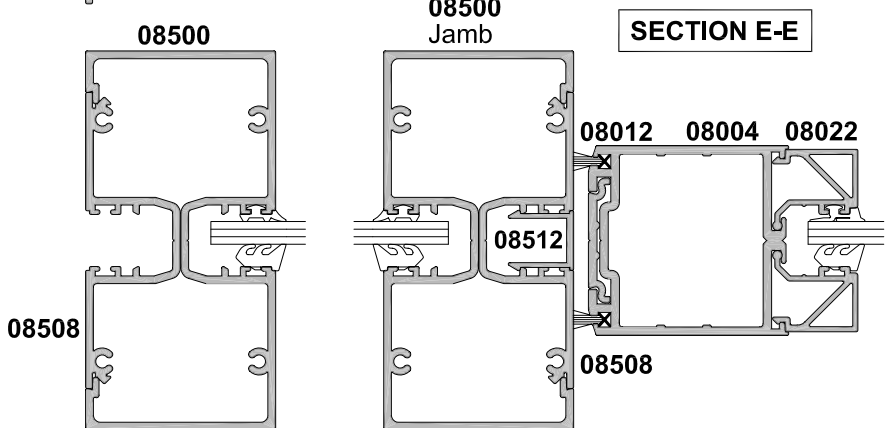
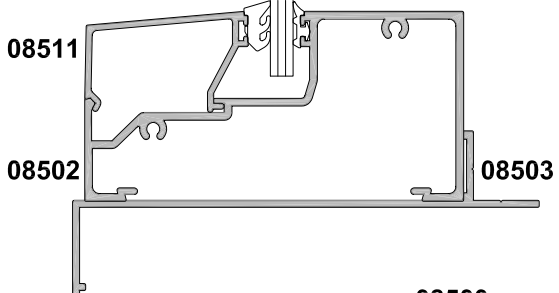
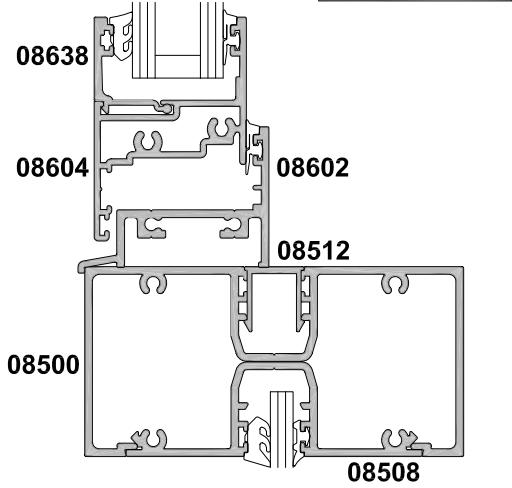

SECTION E-E

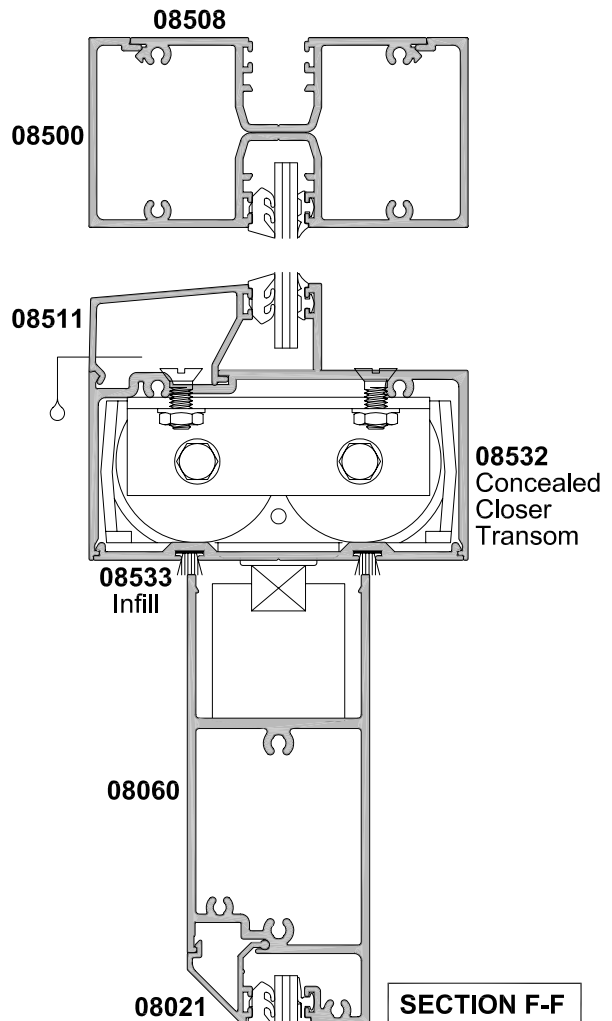

SECTION F-F

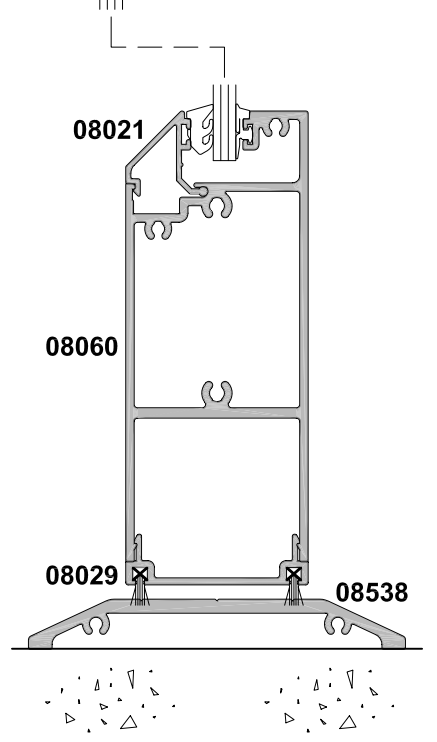

**100MM SHOPFRONT
F100SF BOX TRANSOM,
SPLIT MULLION, FACET & 90° CORNERS**

CROSS SECTION

Date 01.11.09 Scale 1:2

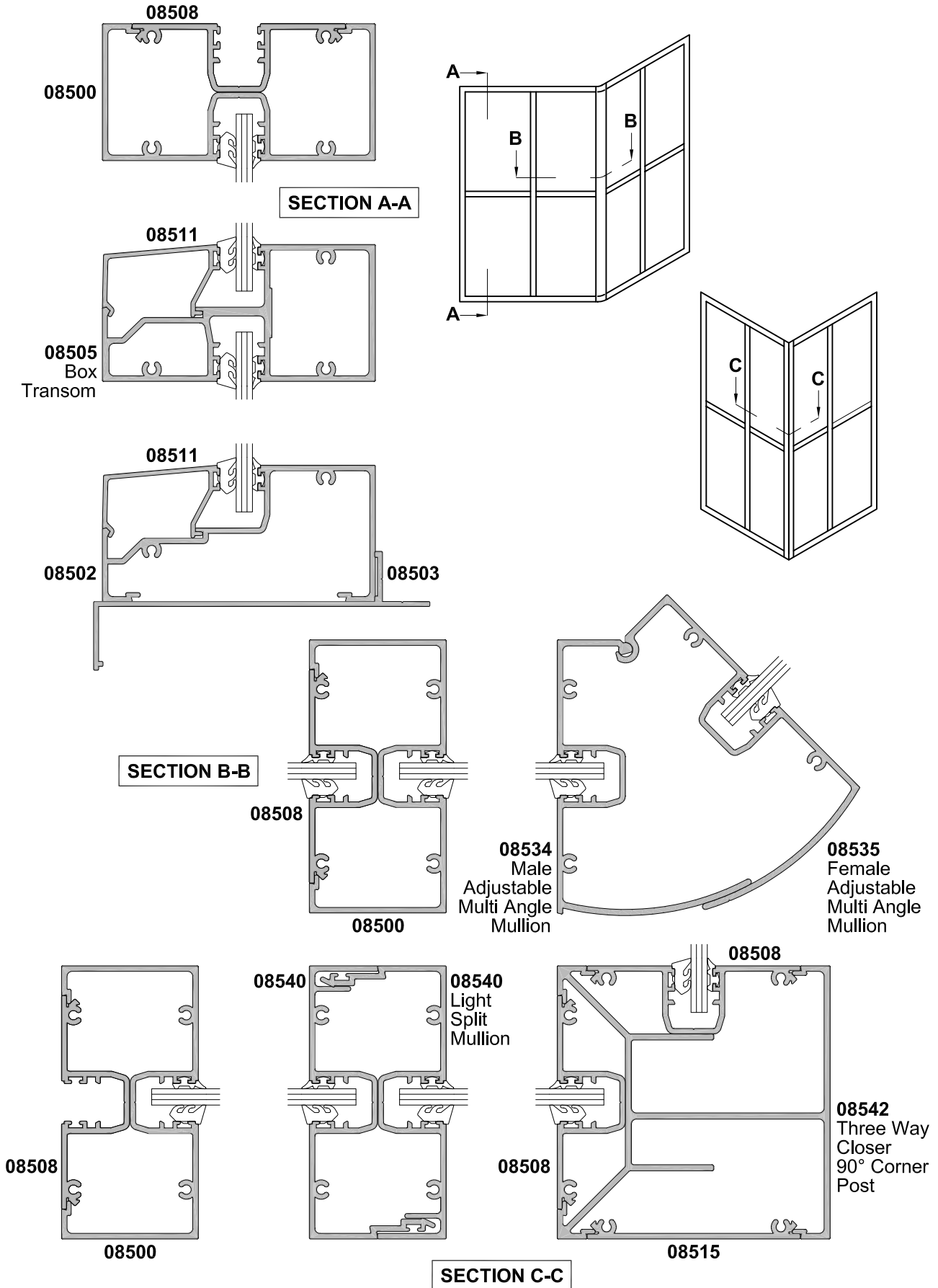

CROSS SECTION

Date 01.11.09 Scale 1:2

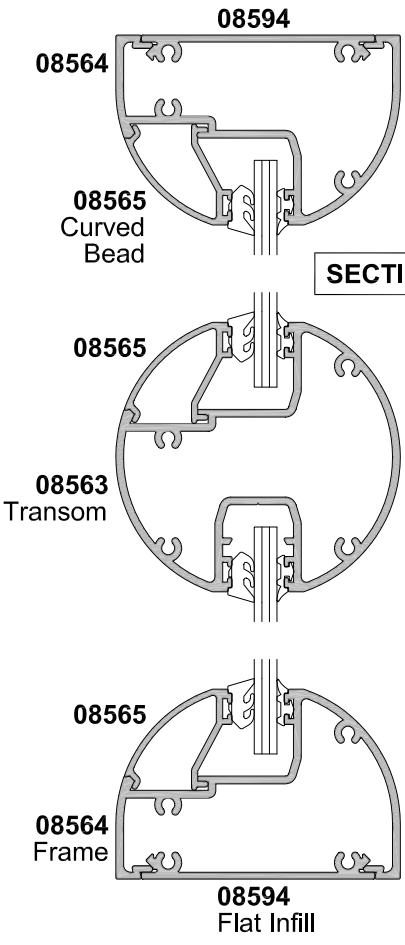

SECTION A-A

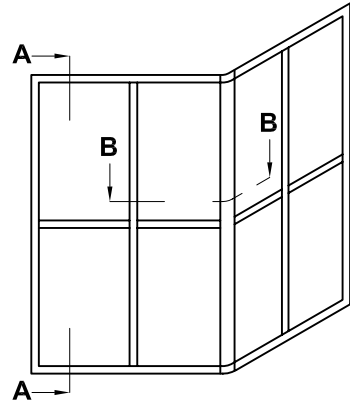

Note -
Only use this product for internal partitioning or external balustrade.

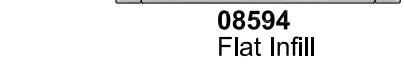
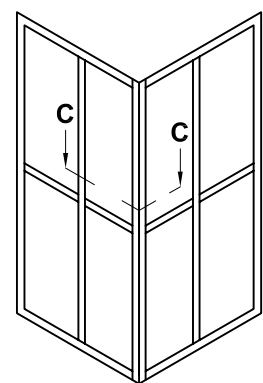

SECTION B-B

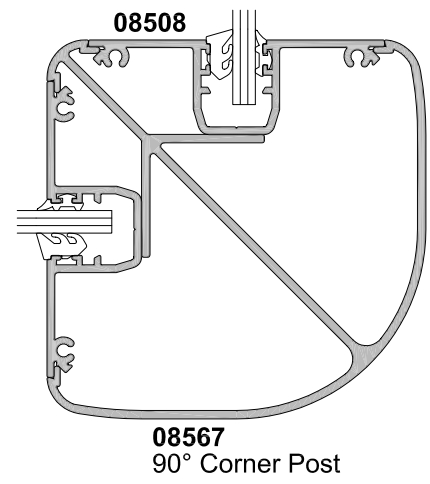
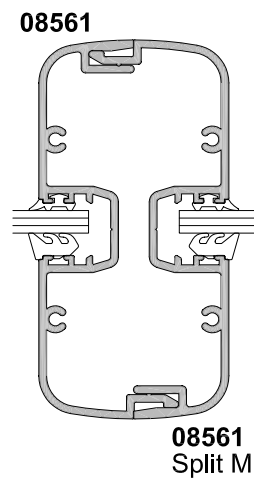
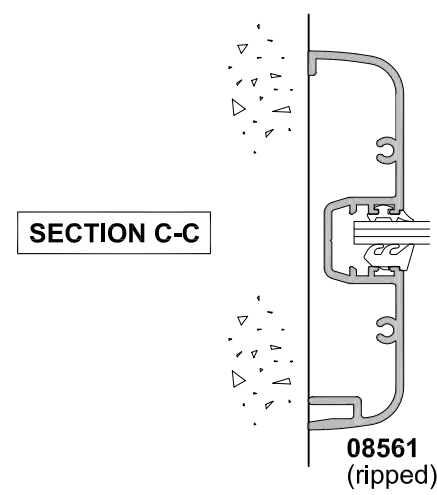
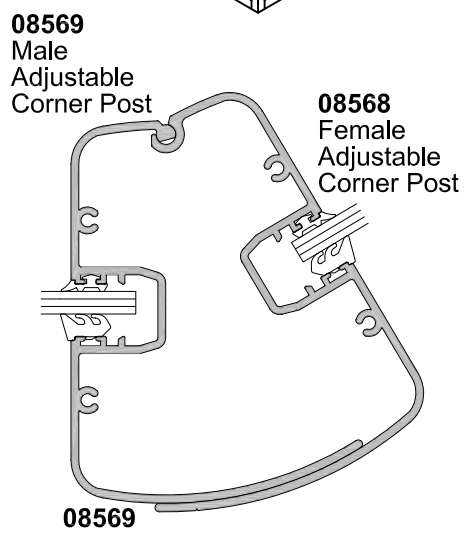
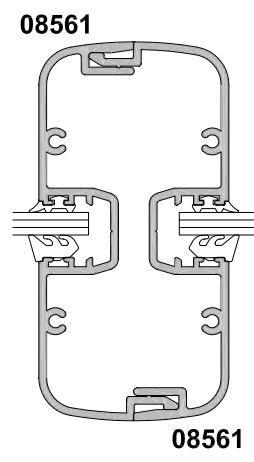

CROSS SECTION

Date 01.11.09 Scale 1:2

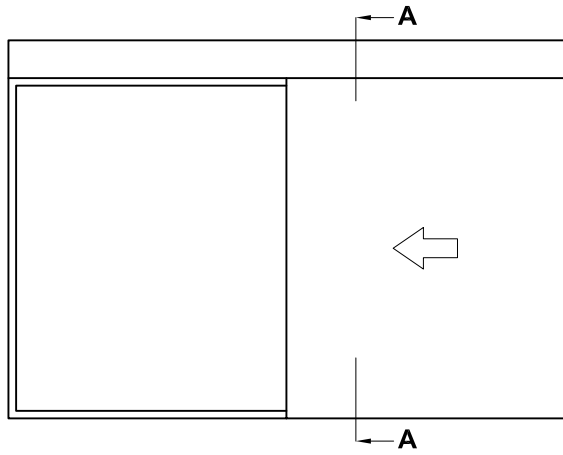

SLIDING DOOR

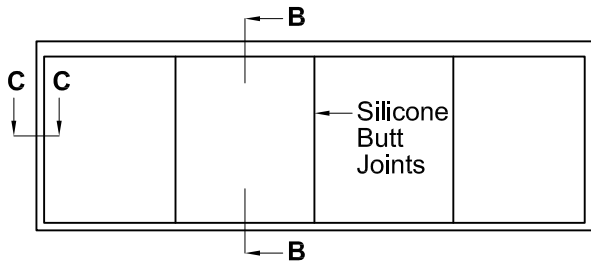

WINDOW

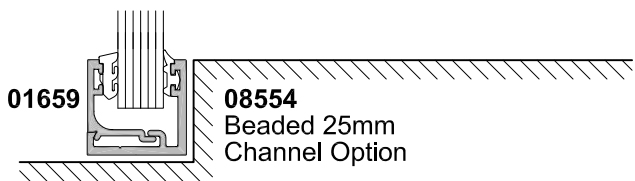
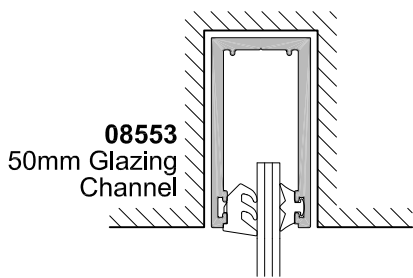
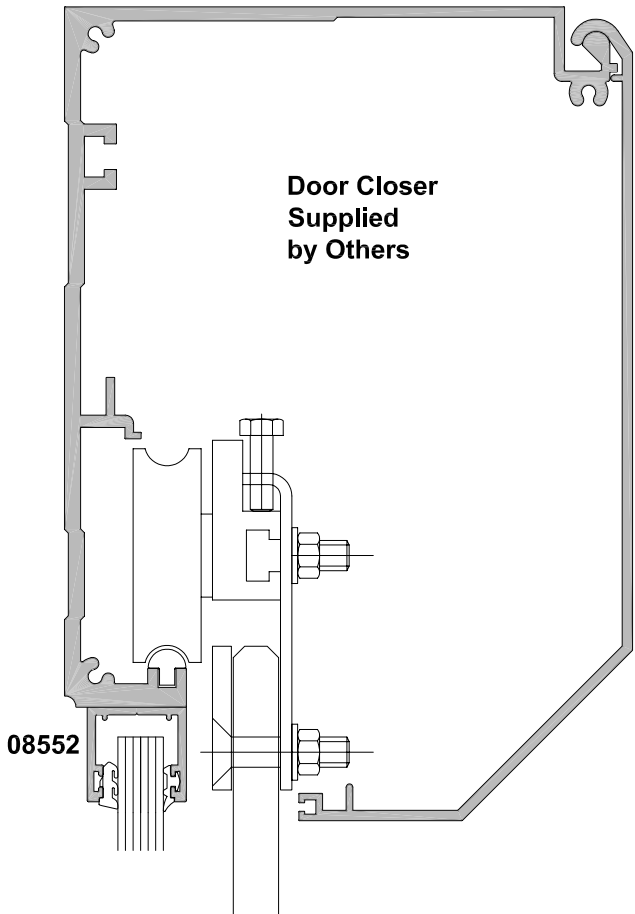

SECTION A-A

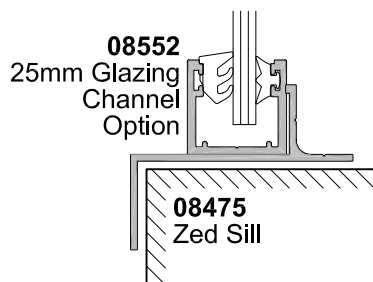

SECTION B-B

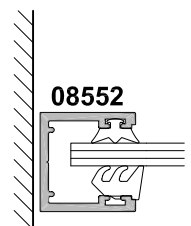

SECTION C-C