

**FIRST THERMAL HEART
BI-FOLD DOOR
OPEN OUT
CROSS SECTION**

Date 01.02.18 Scale 1:2

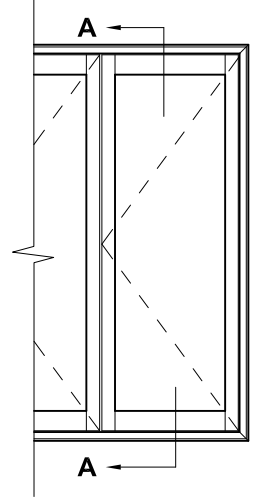

SECTION A-A

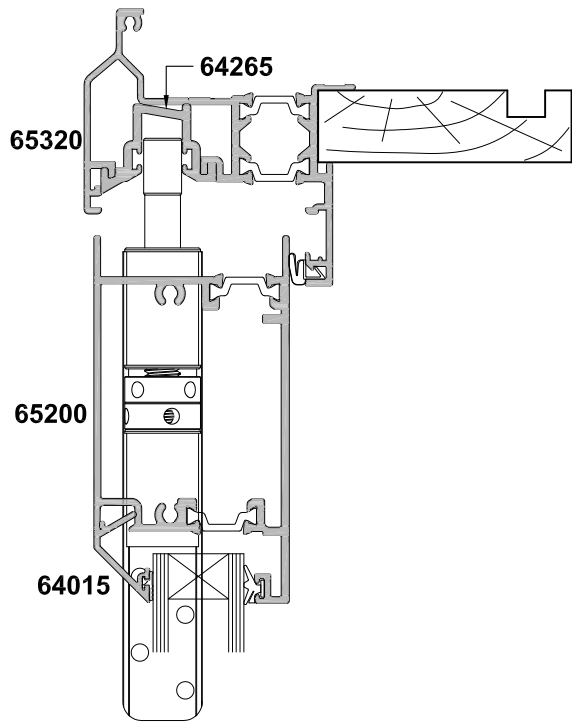
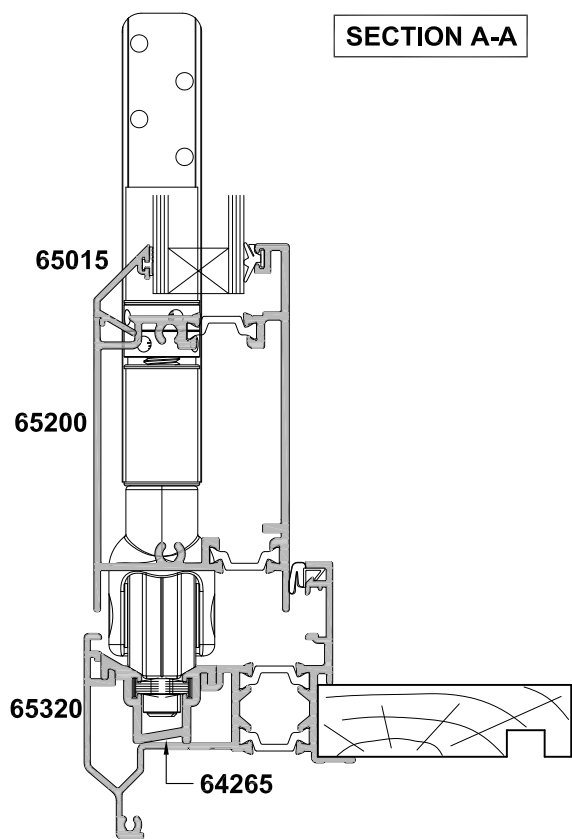

**FIRST THERMAL HEART
BI-FOLD DOOR
OVERLIGHT TRANSOM
CROSS SECTION**

Date 01.02.18 Scale 1:2

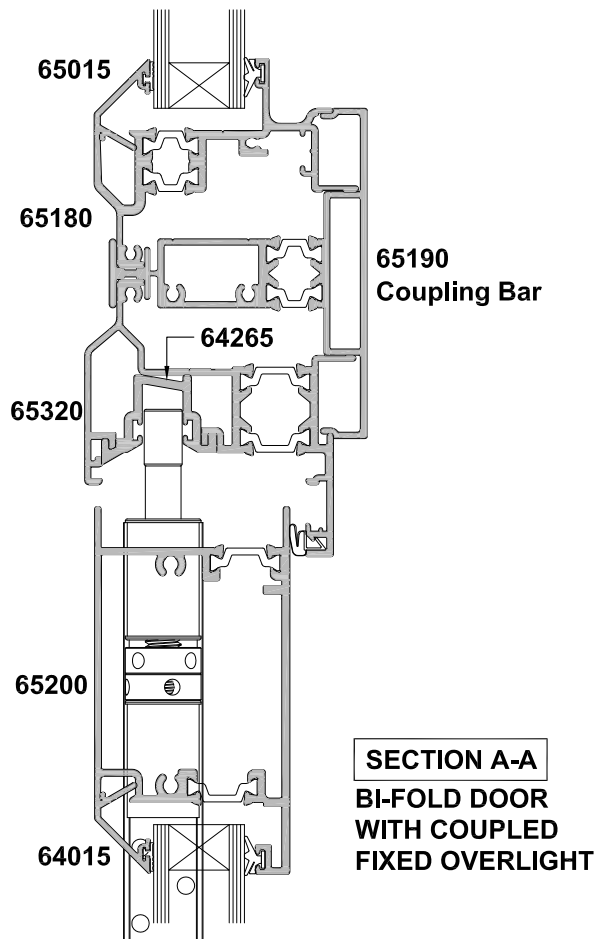
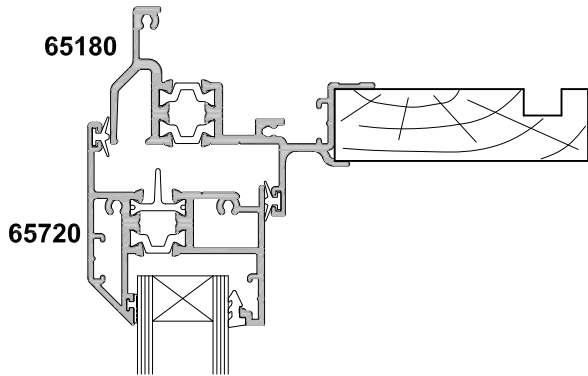
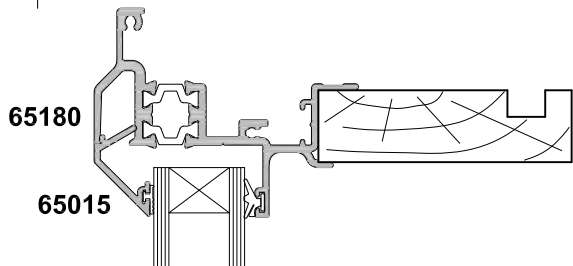
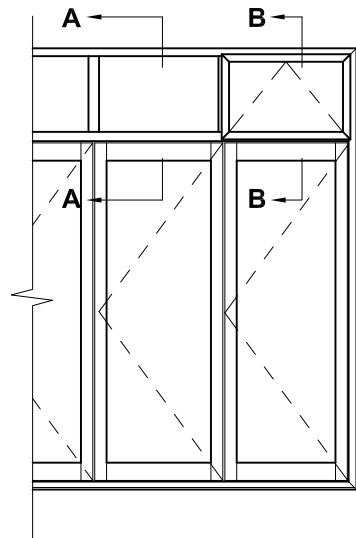

**SECTION A-A
BI-FOLD DOOR
WITH COUPLED
FIXED OVERLIGHT**

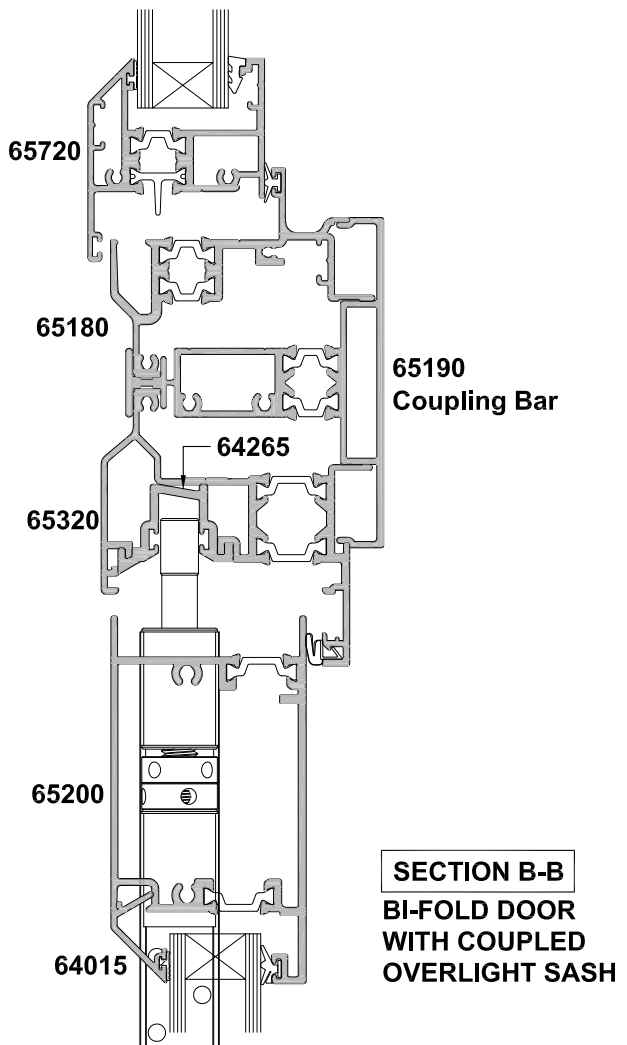

**SECTION B-B
BI-FOLD DOOR
WITH COUPLED
OVERLIGHT SASH**

**FIRST THERMAL HEART
BI-FOLD DOOR
THREE PANEL OPEN OUT DOOR**

CROSS SECTION

Date 01.02.18 Scale 1:2

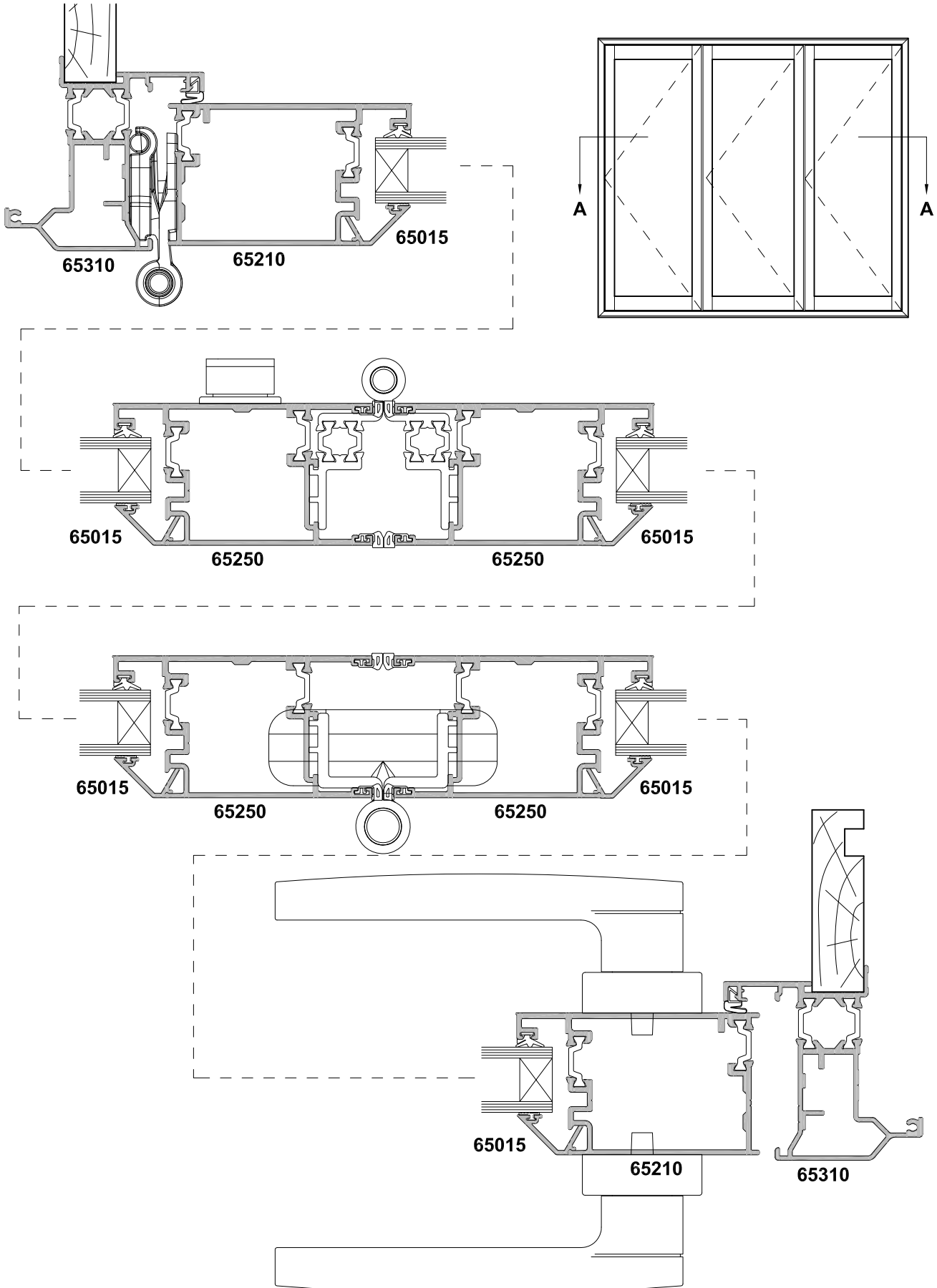

**FIRST THERMAL HEART
BI-FOLD DOOR MEETING STILES**

CROSS SECTION

Date 01.02.18 Scale 1:2

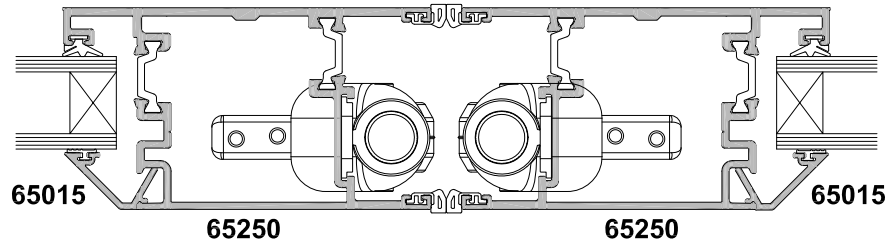
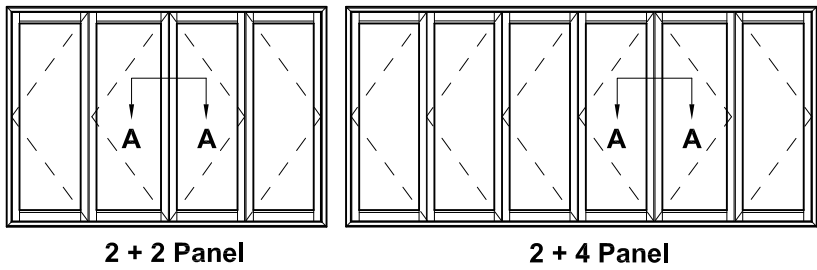

SECTION A-A

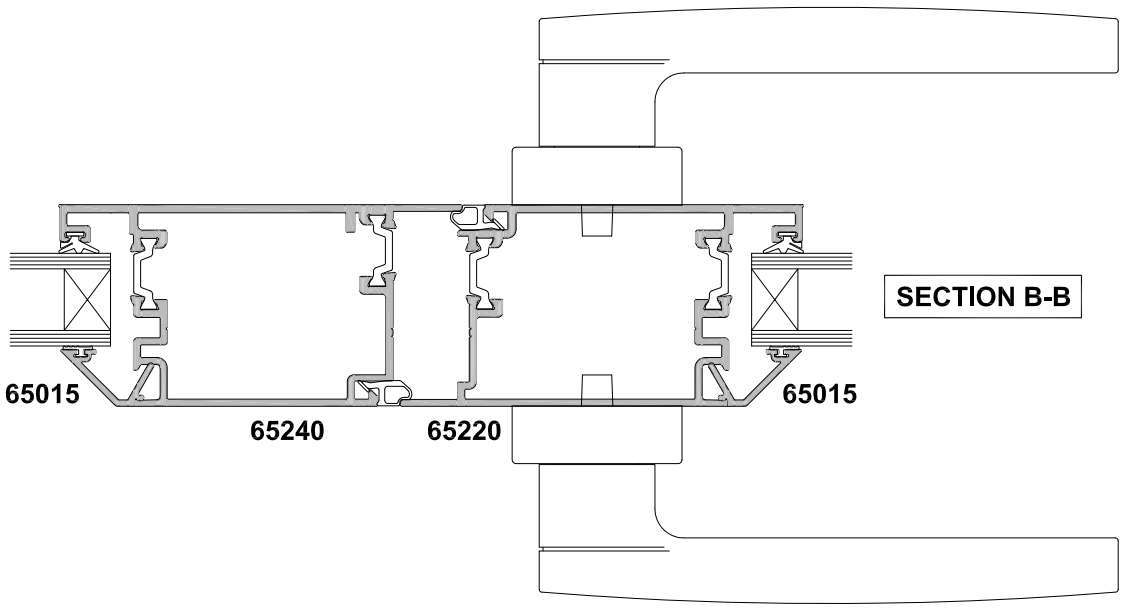
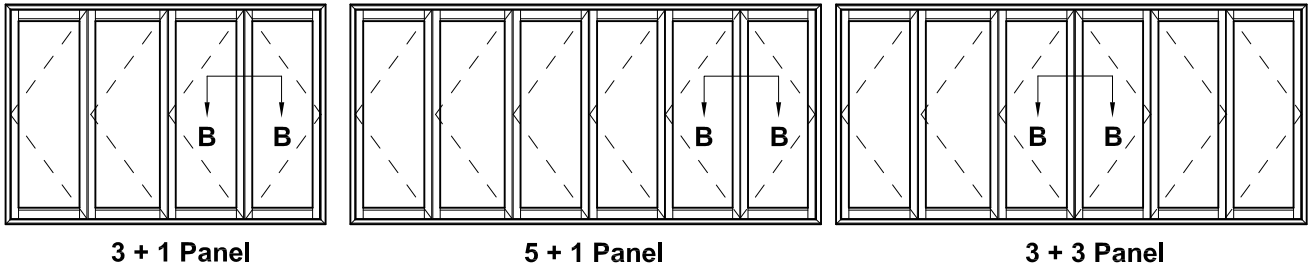

SECTION B-B

**FIRST THERMAL HEART
BI-FOLD DOOR
MEETING STILES**

CROSS SECTION

Date 01.02.18 Scale 1:2

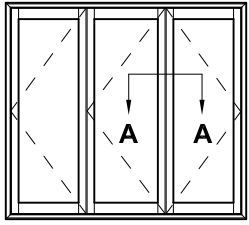

2 + 1 Panel

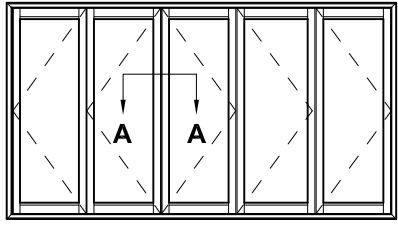

2 + 3 Panel

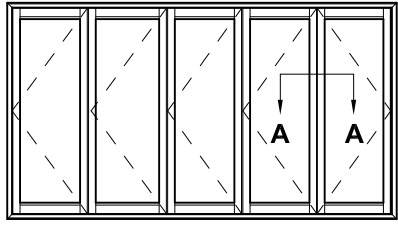

4 + 1 Panel

