

**METRO SERIES
BI-FOLD DOOR
MEETING STILES**

CROSS SECTION

Date 01.03.17 Scale 1:2

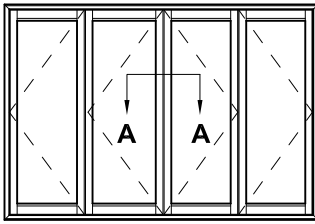

2 + 2 Panel

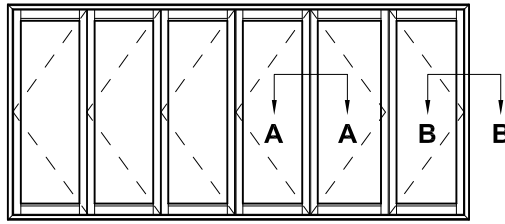

2 + 4 Panel

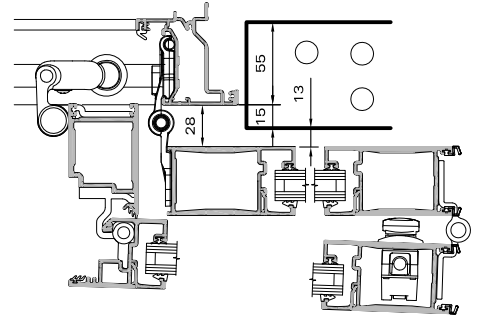

SECTION B-B

Scale: NTS

STANDARD STILE
(Any side with even number of panels)

LAY-BACK STILE OPTION
(Two panel sides only)

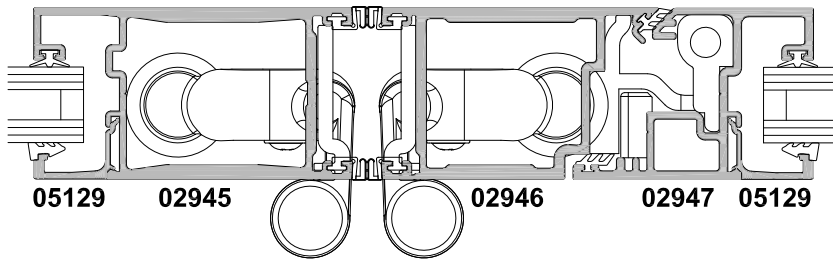

SECTION A-A

Lay-Back Installation Restrictions

When the Lay-Back panels are opened fully they sit 28mm off the front face of the frame. For the vast majority of cladding options, this will not be an issue, but in the following options it will be:

- Brick Veneer
- Recessed EIFS (plaster clad Poly)
- Concrete Block
- Precast Concrete Panel

In these Claddings the frame will need to be installed with the facings over the face of the cladding, or recessed no more than 15mm as shown (to provide a minimum 13mm clearance when open).

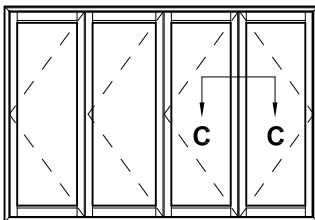

3 + 1 Panel

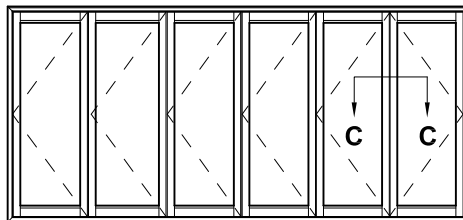

5 + 1 Panel

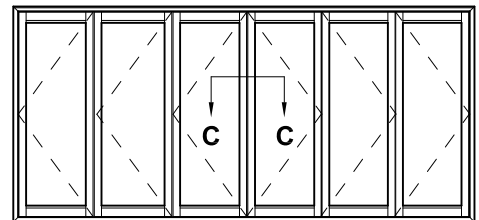

3 + 3 Panel

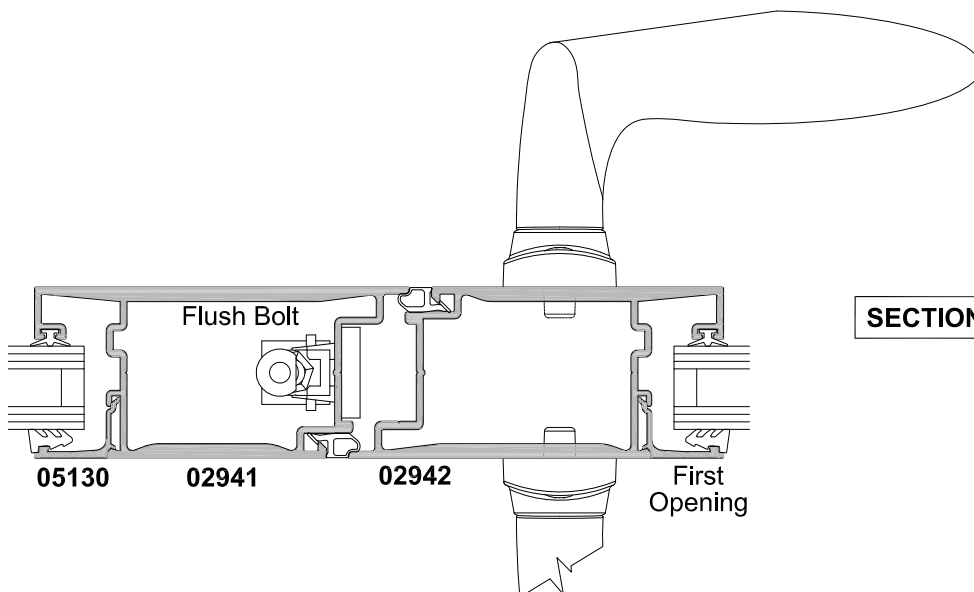

SECTION C-C