

CROSS SECTION

Date 01.11.09 Scale 1:2

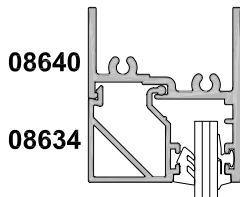

SECTION A-A

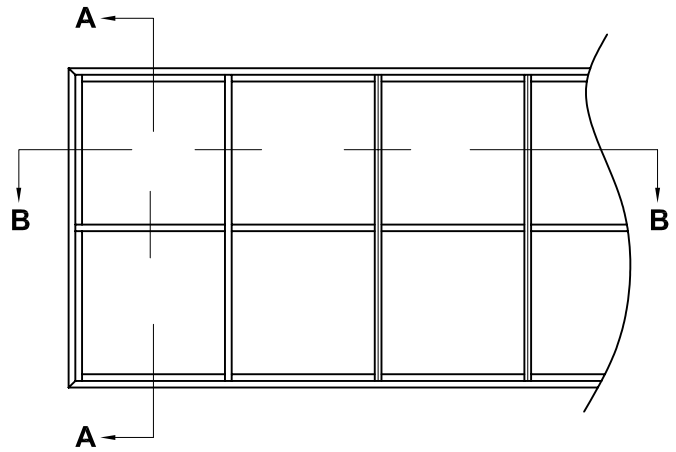
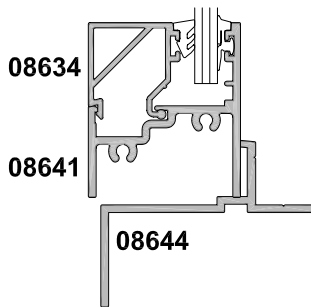
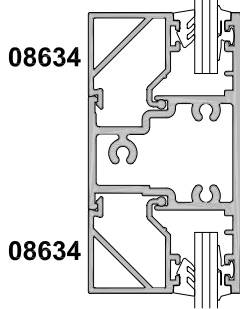

SECTION B-B

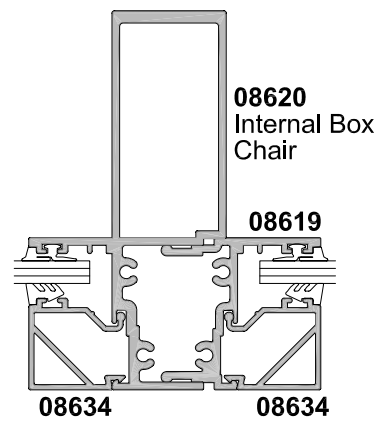
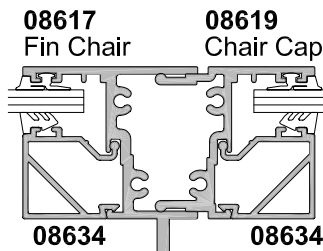
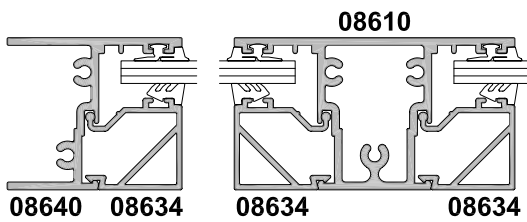

Refer to tables for span requirements