

CROSS SECTION

Date 01.08.16 Scale 1:3

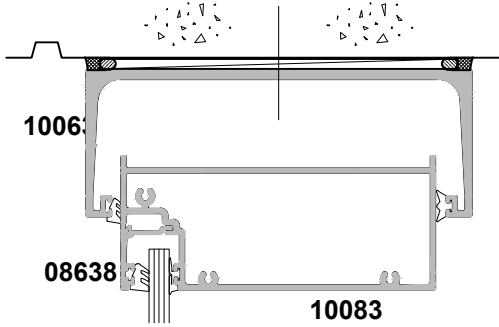

SECTION A-A

Deadload Brackets
(design specific)

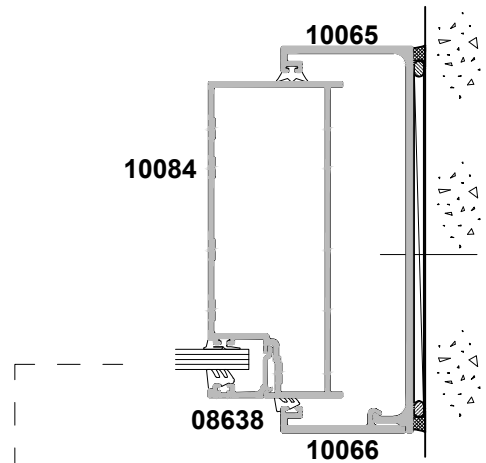
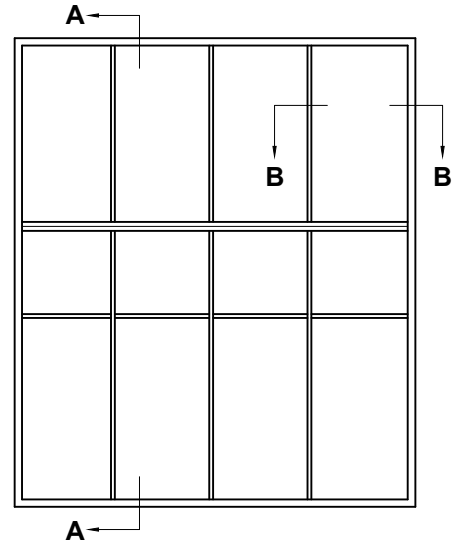
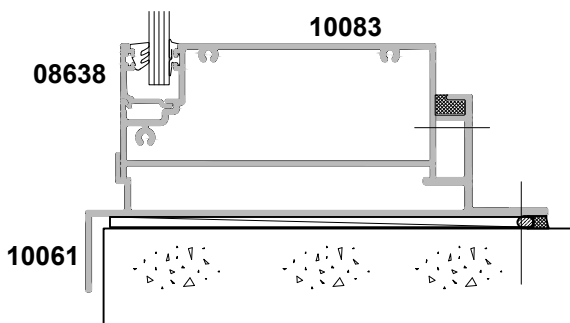
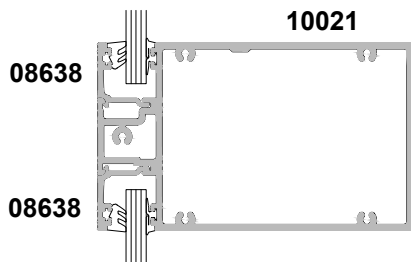
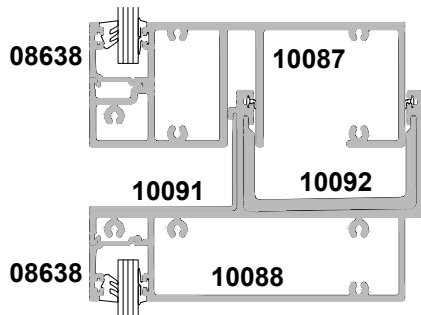
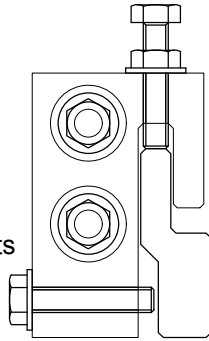

SECTION B-B

Deadload Bracket
(design specific)

