

METRO SERIES
COMPRESSION SLIDING DOOR
TWO PANEL SF
CROSS SECTION

Date 01.09.20 Scale 1:2

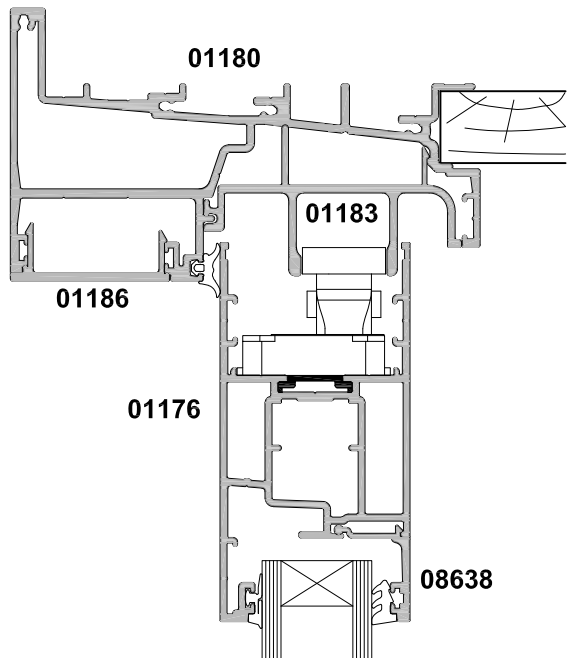

SECTION A-A

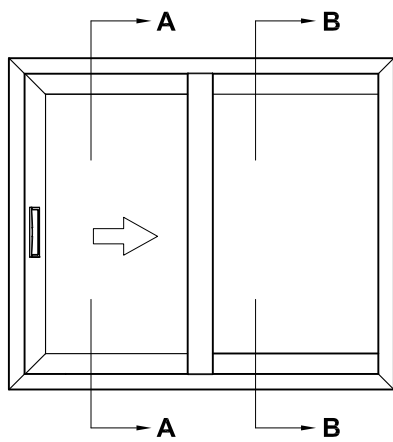
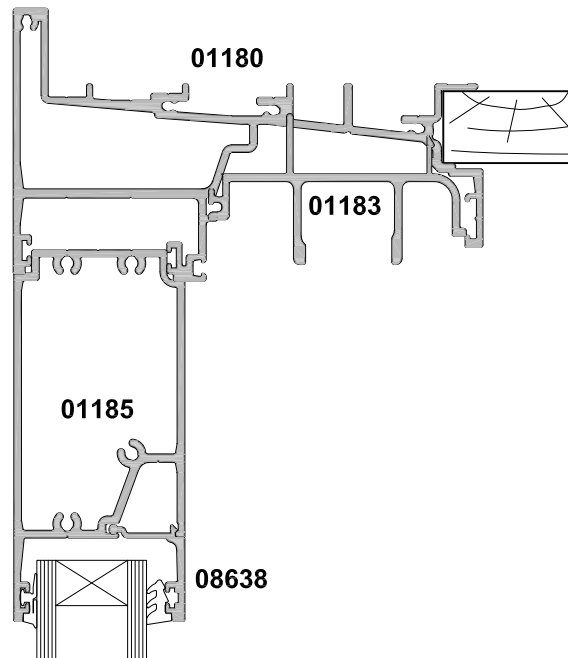

SECTION B-B

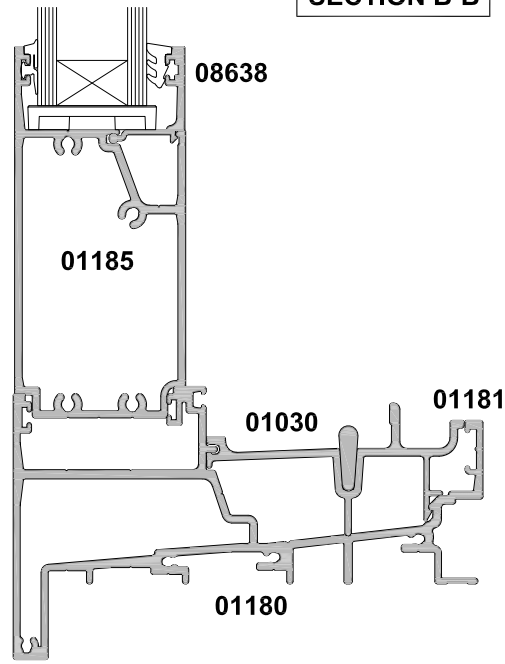
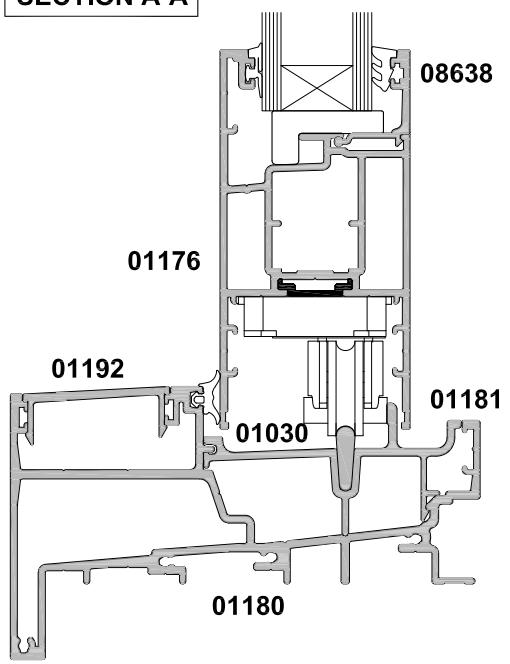

**METRO SERIES
COMPRESSION SLIDING DOOR
TWO PANEL SF
CROSS SECTION**

Date 01.09.20 Scale 1:2

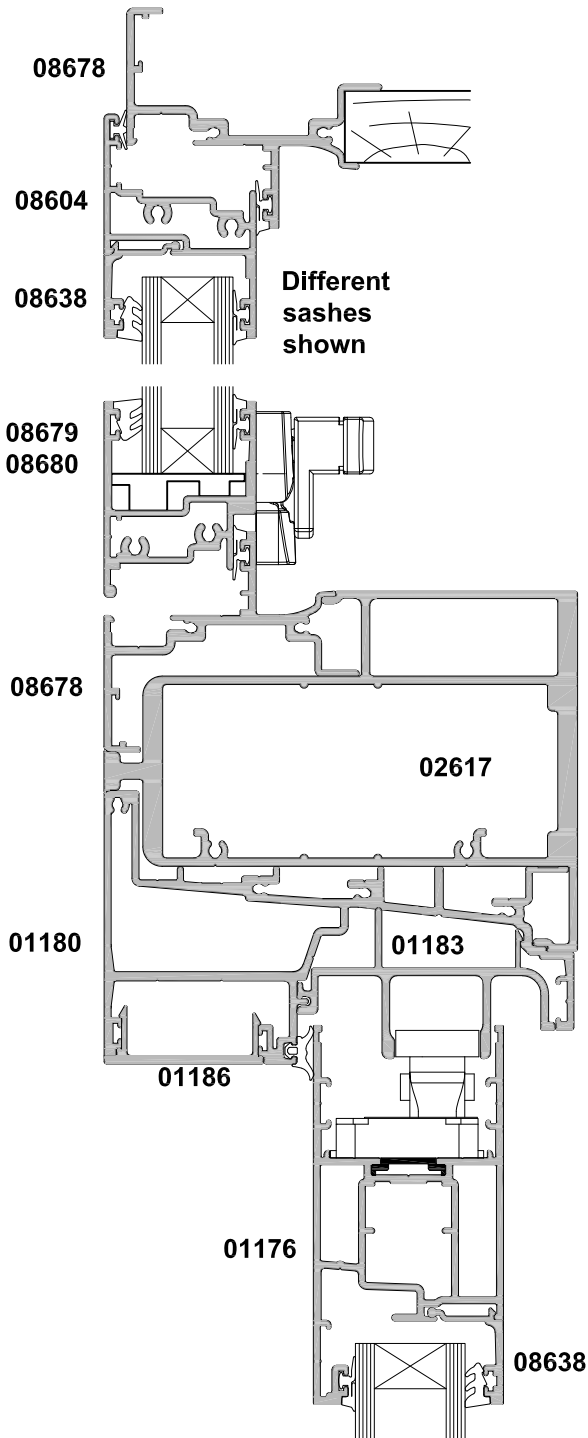
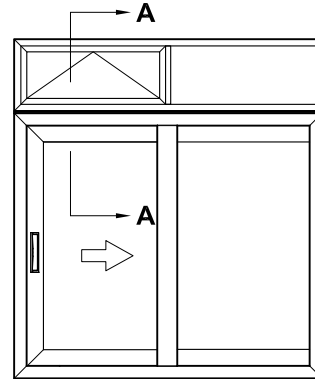

METRO SERIES
COMPRESSION SLIDING DOOR
TWO PANEL SF
CROSS SECTION

Date 01.09.20 Scale 1:2

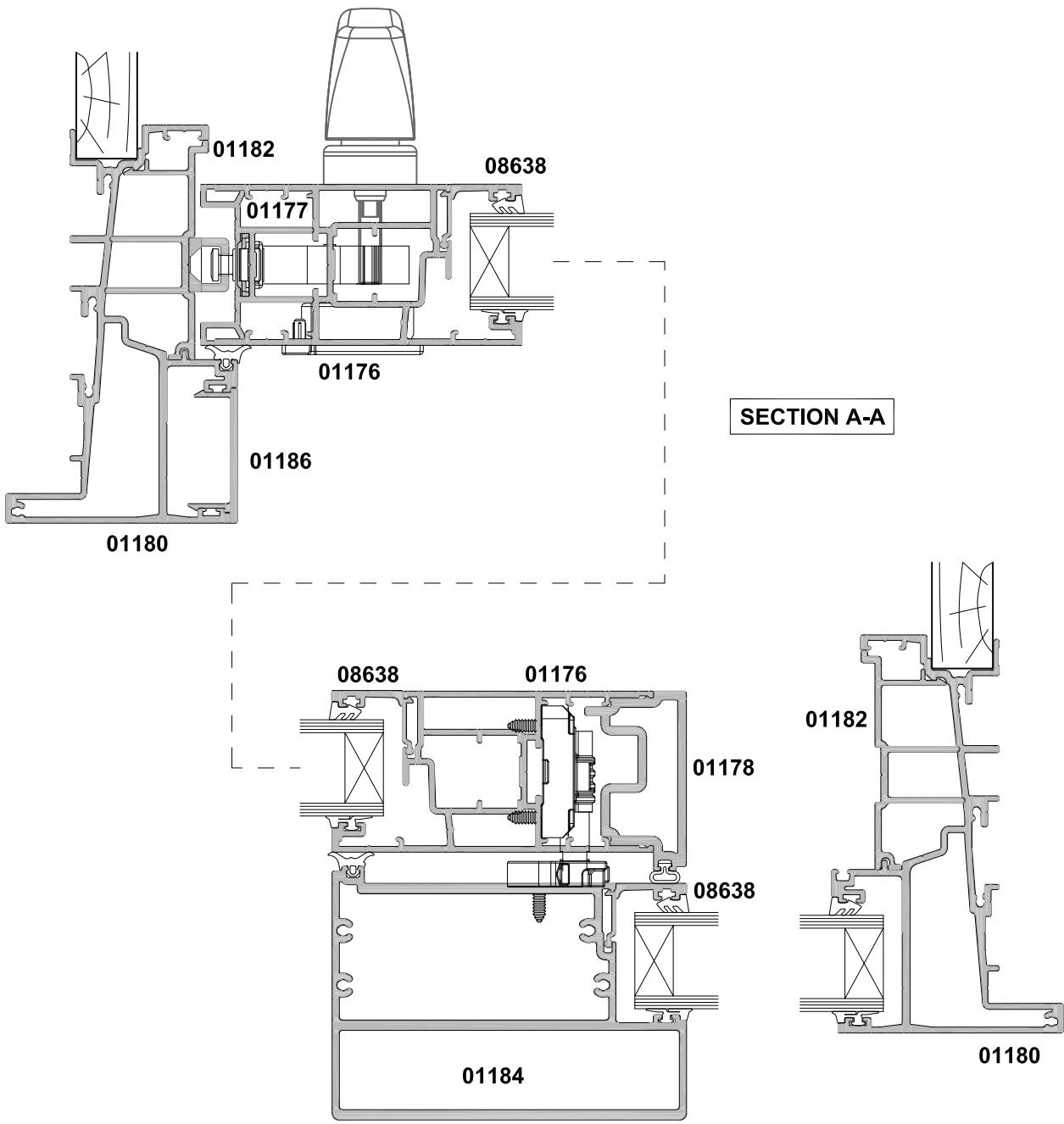
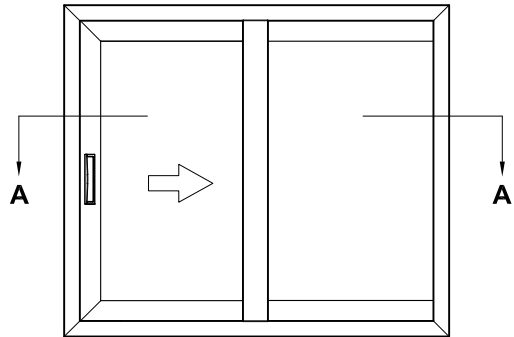

**METRO SERIES
COMPRESSION SLIDING DOOR
BI-PARTING FSSF
CROSS SECTION**

Date 01.09.20 Scale 1:2

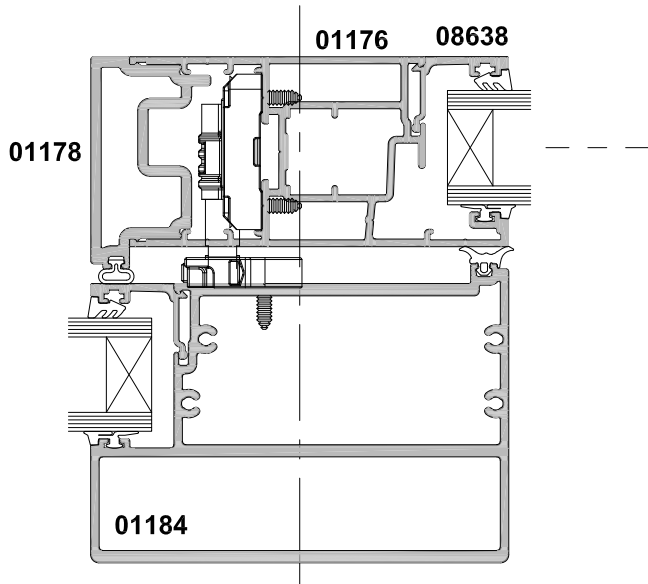
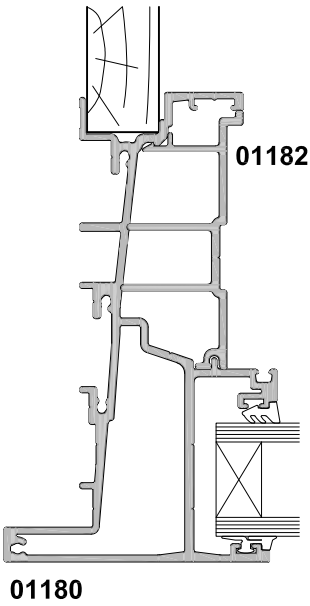
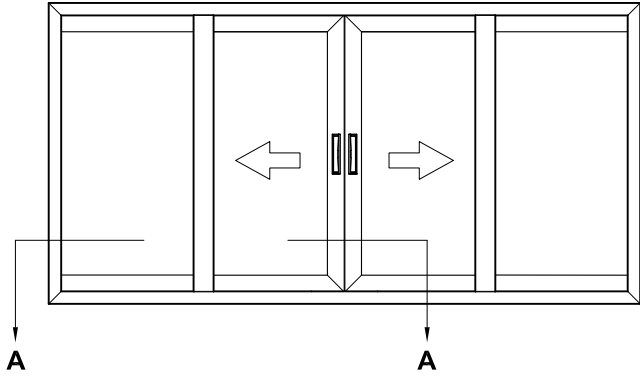

SECTION A-A

