

SECTION A-A

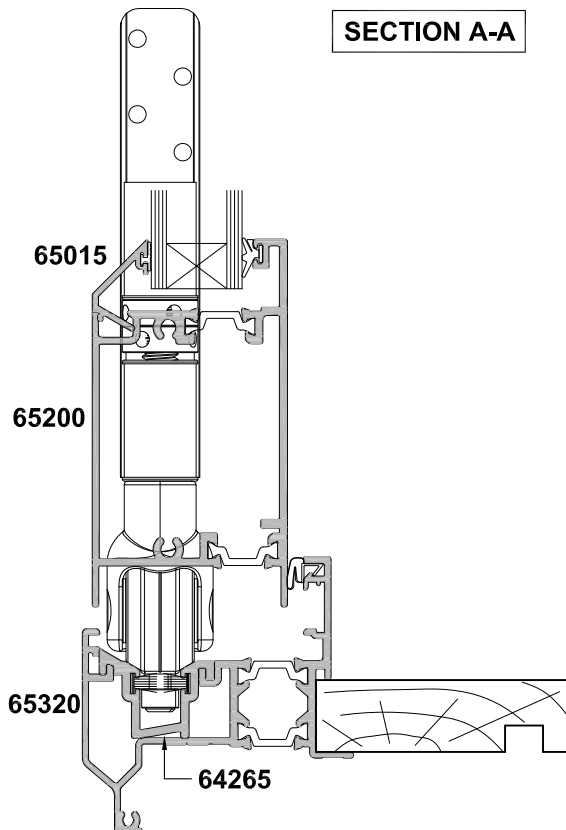

ALThERM THERMAL HEART, BI-FOLD DOOR OVERLIGHT TRANSOM CROSS SECTION

Cad Ref. ARTBD03-0 Scale 1:2 Date 01.02.18

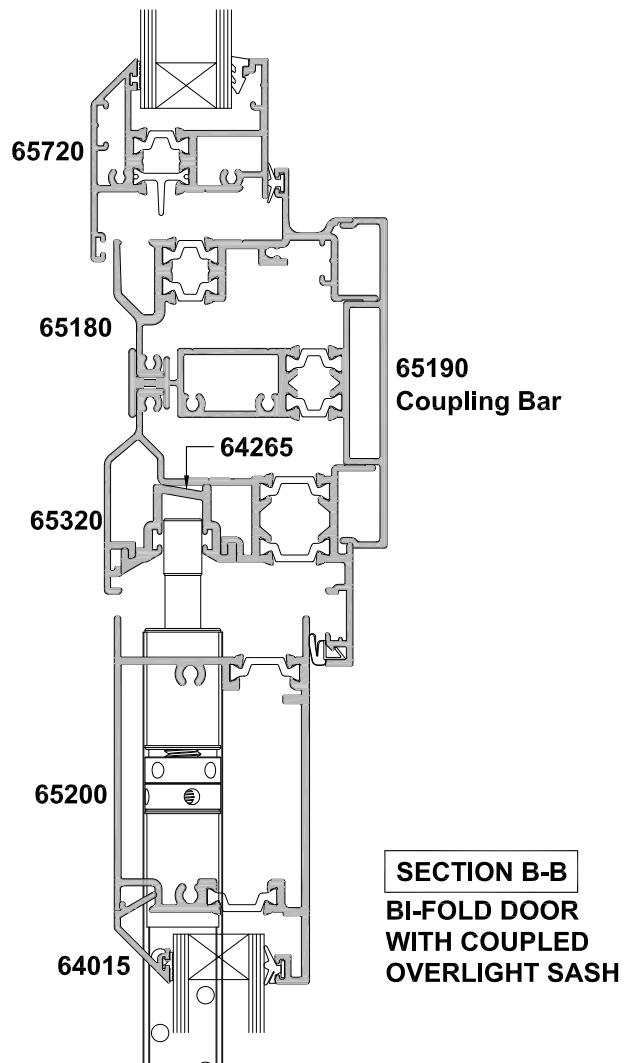
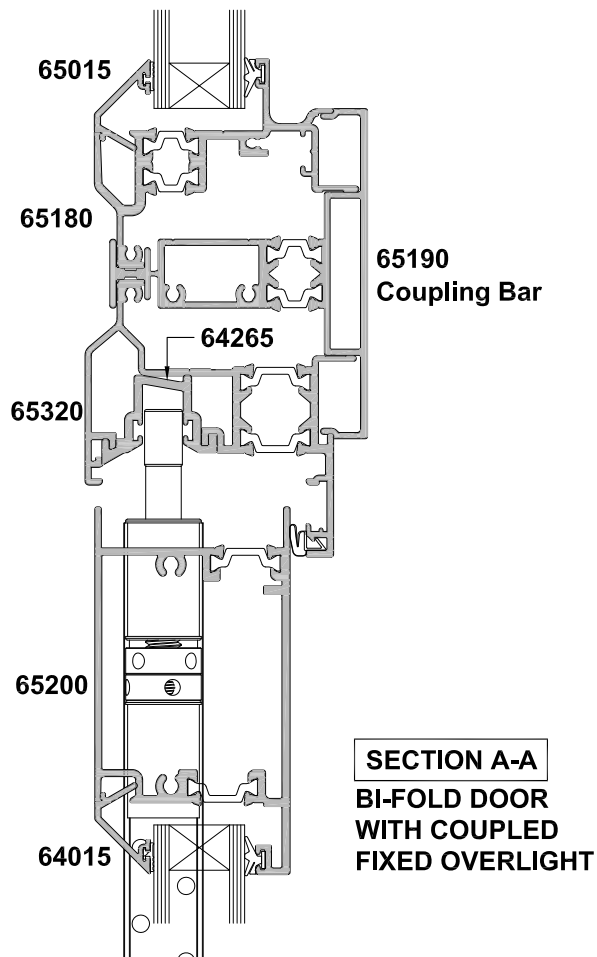
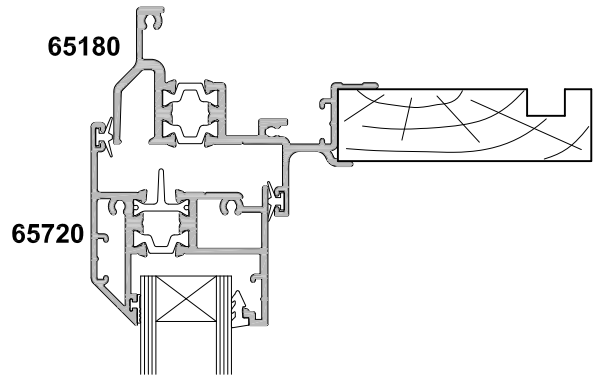
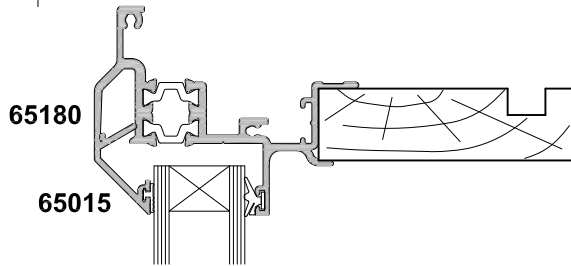
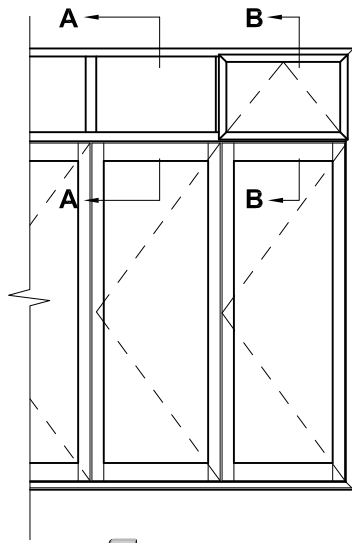

ALTherm THERMAL HEART, BI-FOLD DOOR THREE PANEL OPEN OUT DOOR CROSS SECTION

Cad Ref. ARTBD04-0 Scale 1:2 Date 01.02.18

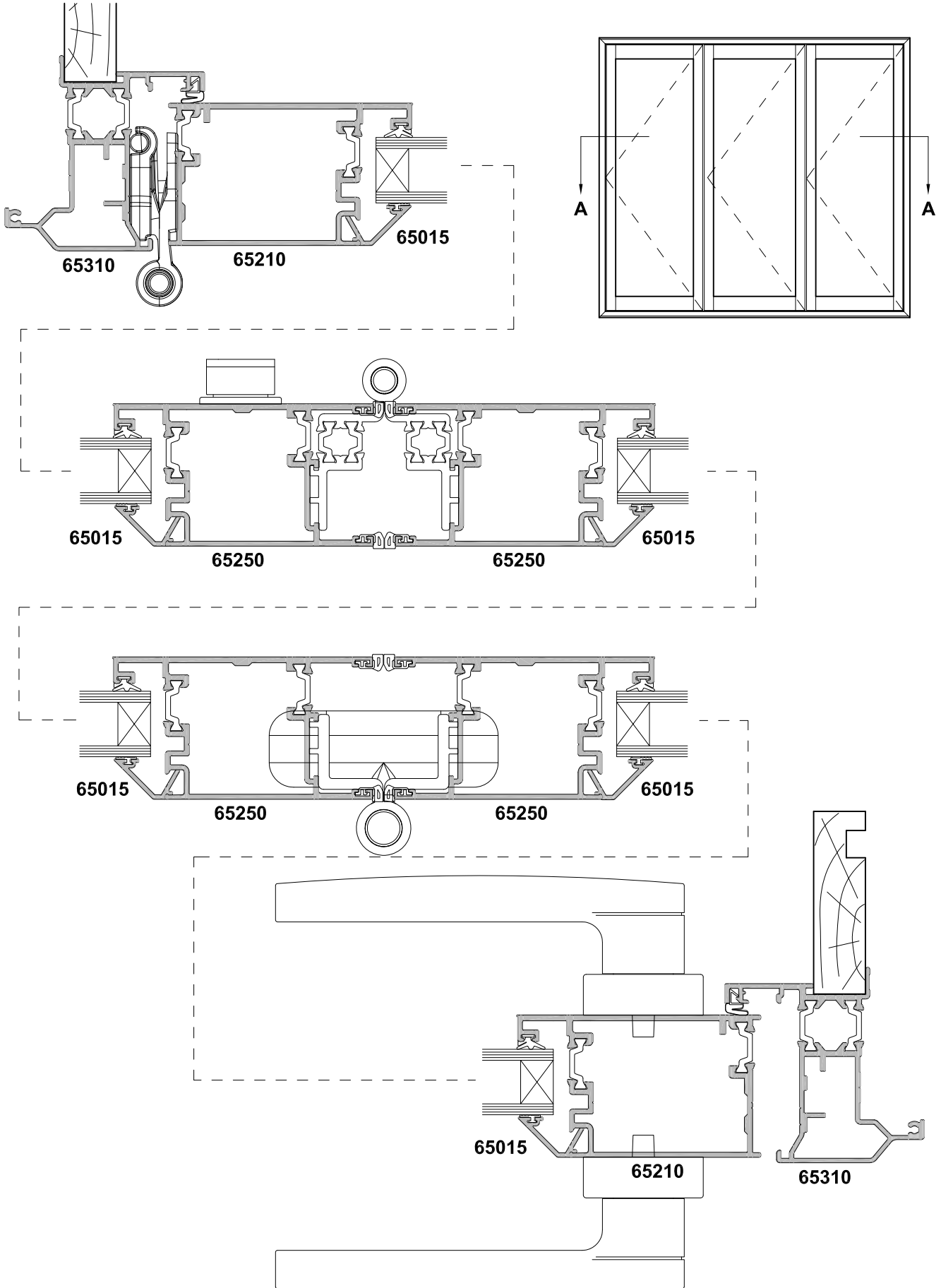

ALThERM THERMAL HEART, BI-FOLD DOOR MEETING STILES

CROSS SECTION

Cad Ref. ARTBD05-0 Scale 1:2 Date 01.02.18

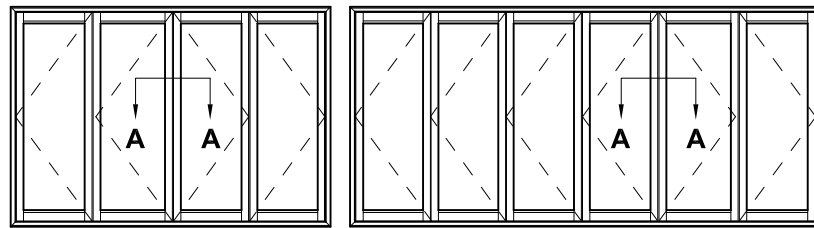

2 + 2 Panel

2 + 4 Panel

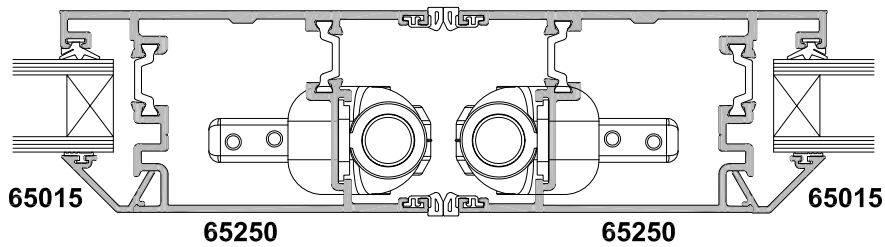

SECTION A-A

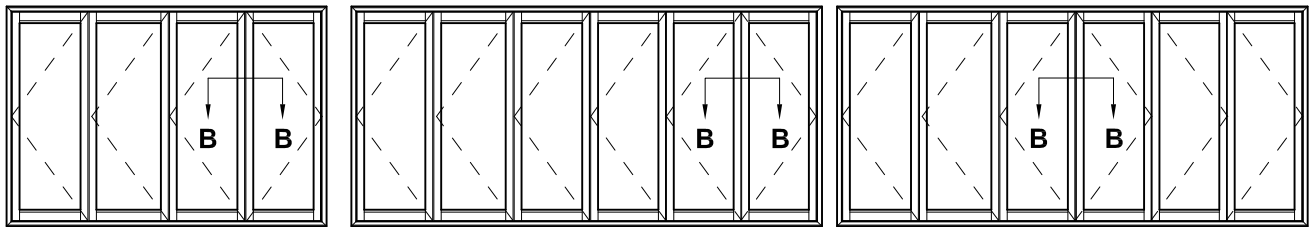

3 + 1 Panel

5 + 1 Panel

3 + 3 Panel

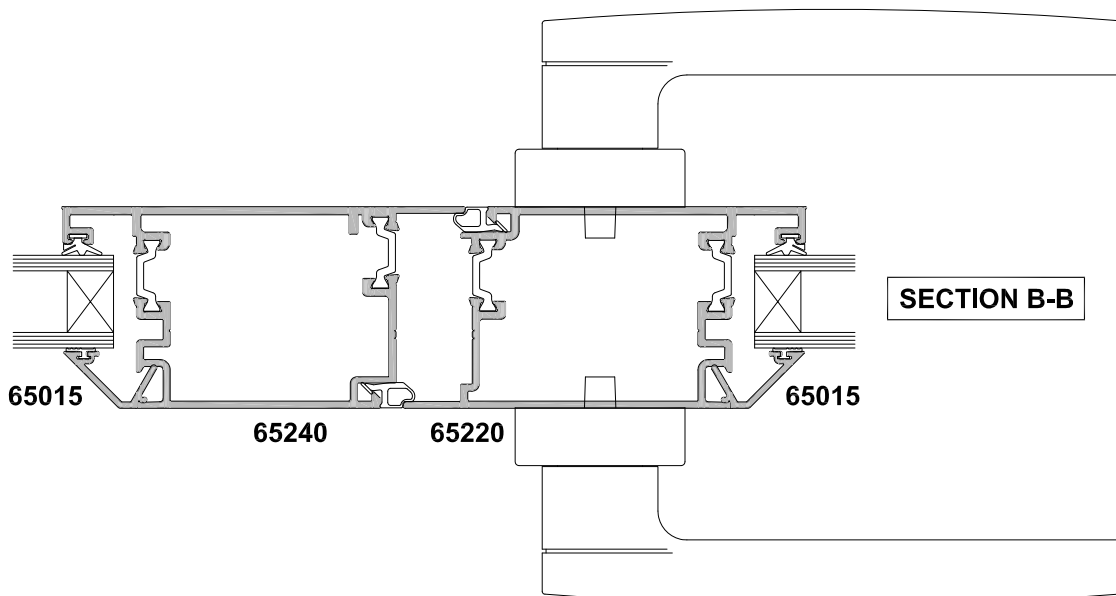

SECTION B-B

ALThermThermal Heart, BI-FOLD DOOR MEETING STILES CROSS SECTION

Cad Ref. ARTBD06-0 Scale 1:2 Date 01.02.18

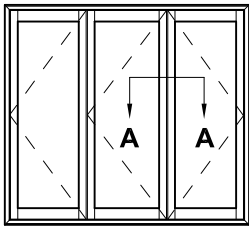

2 + 1 Panel

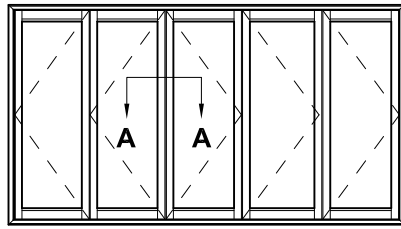

2 + 3 Panel

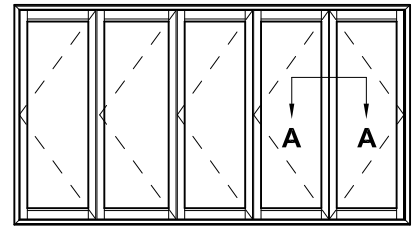

4 + 1 Panel

