

# SLIDING DOOR TWO PANEL FS WITH SIDELIGHT SASH CROSS SECTION

Cad Ref. ASD01-0    Scale 1:2    Date 01.04.19

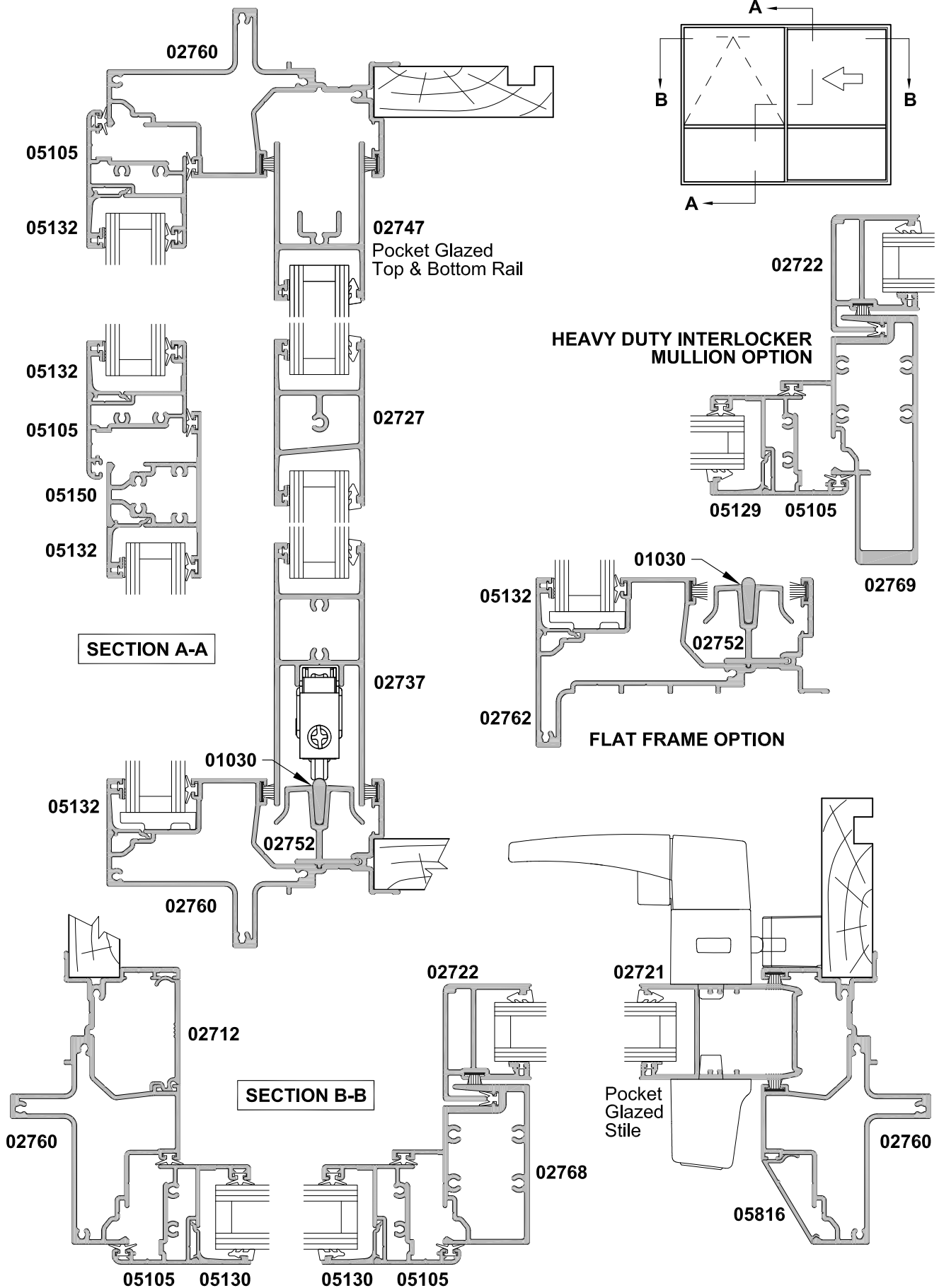

# SLIDING DOOR, TWO PANEL FS WITH OVERLIGHT TRANSOM AND COUPLING OPTIONS CROSS SECTION

Cad Ref. ASD02-0    Scale 1:2    Date 01.04.19

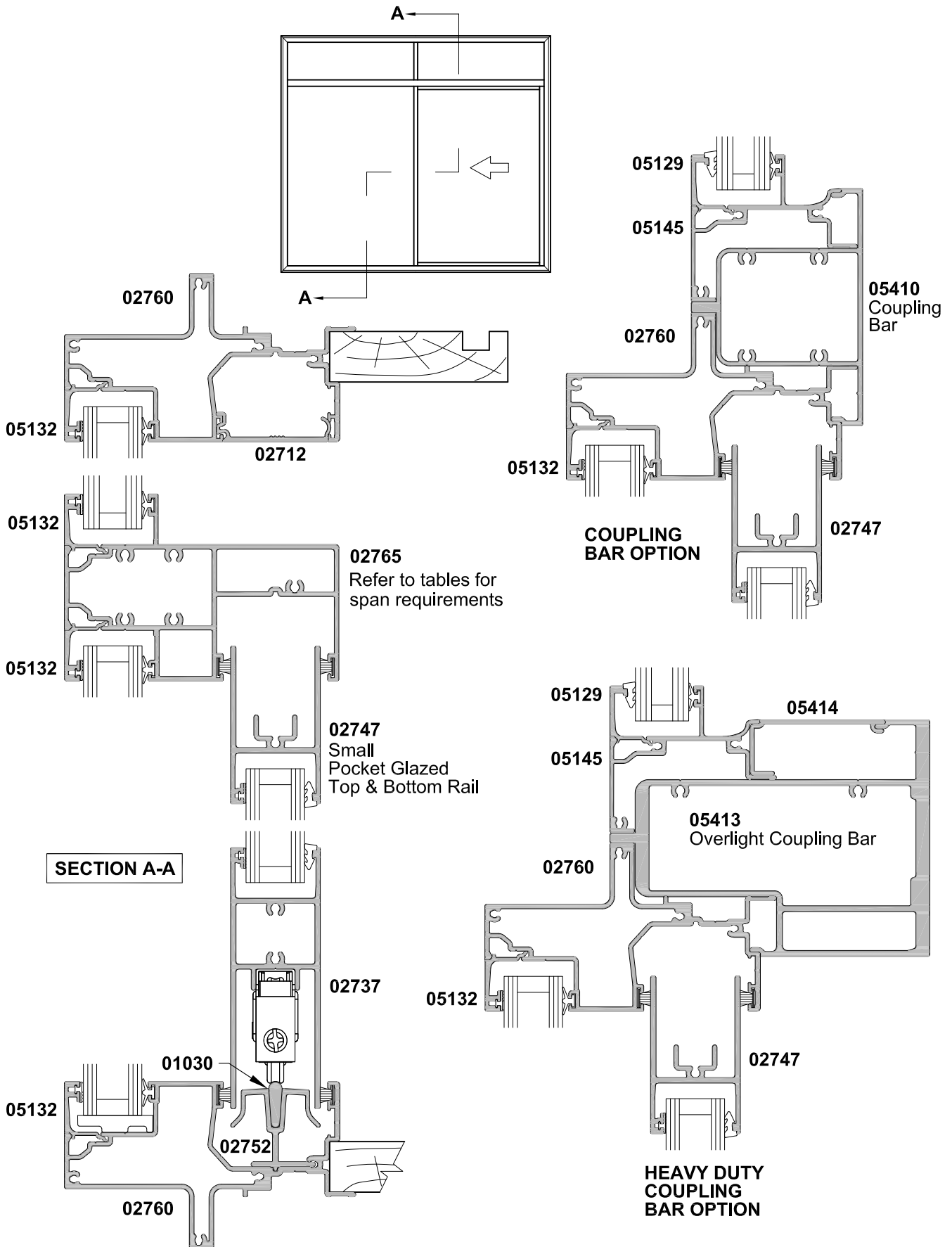

# SLIDING DOOR, THREE PANEL FSF

## CROSS SECTION

Cad Ref. ASD03-0

Scale 1:2

Date 01.04.19

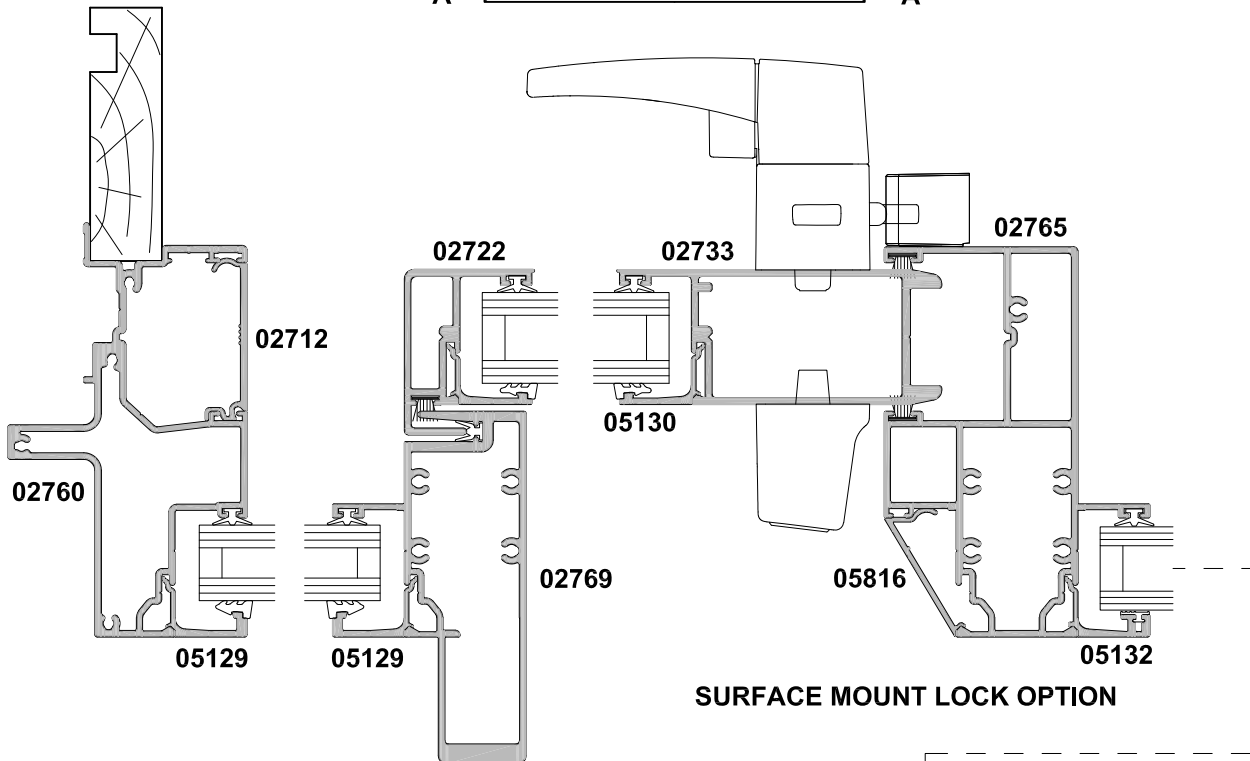
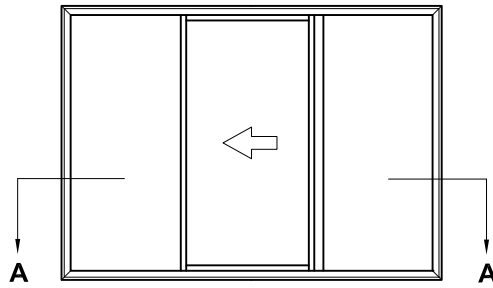

**SECTION A-A**

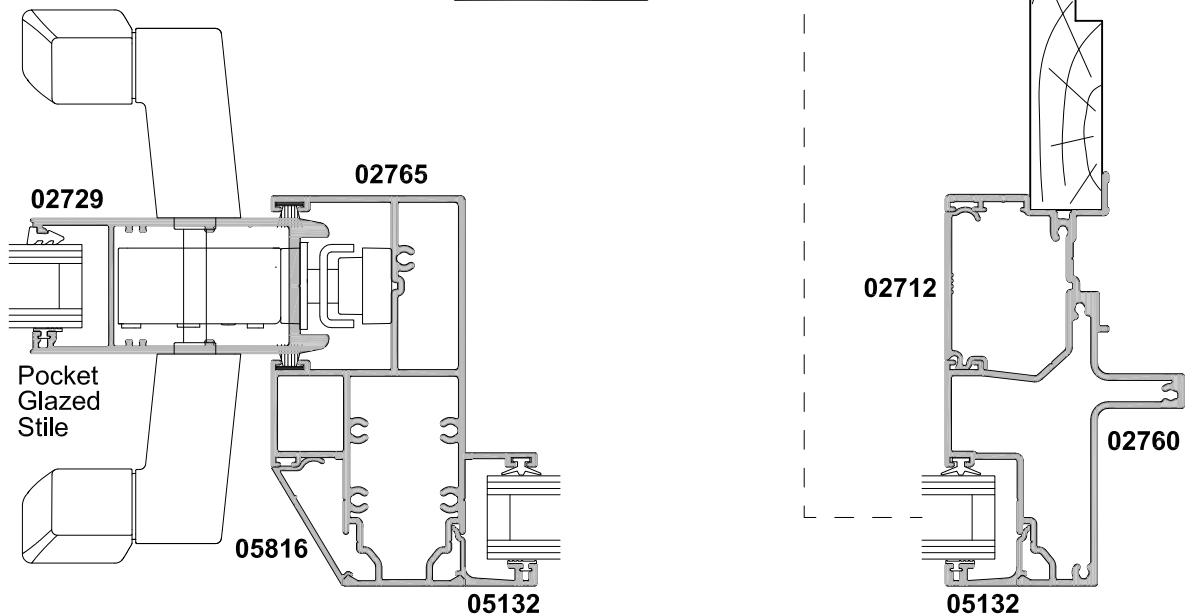

# SLIDING DOOR, FOUR PANEL FSSF

## CROSS SECTION

Cad Ref. ASD04-0

Scale 1:2

Date 01.04.19

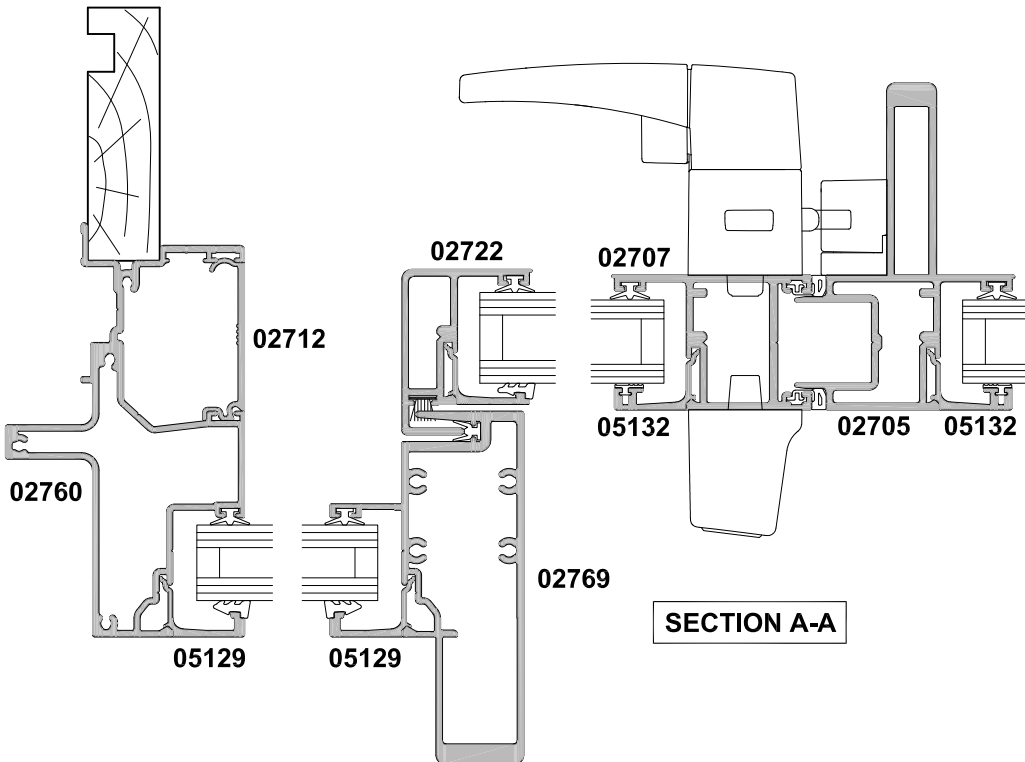
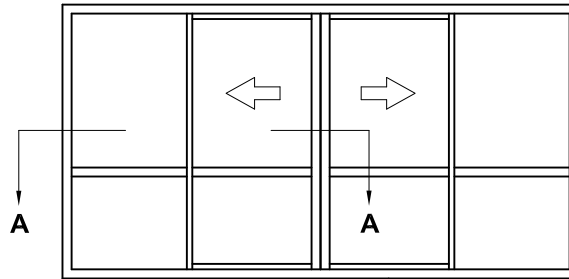

**02708**  
Sliding Door 4PJ

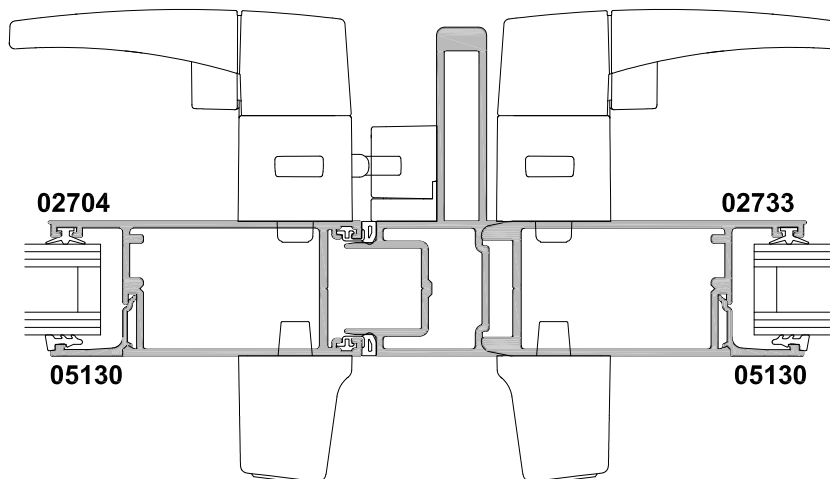

**HEAVY DUTY OPTION**

# SLIDING DOOR, TWO PANEL SS

## CROSS SECTION

Cad Ref. ASD05-0

Scale 1:2

Date 01.04.19

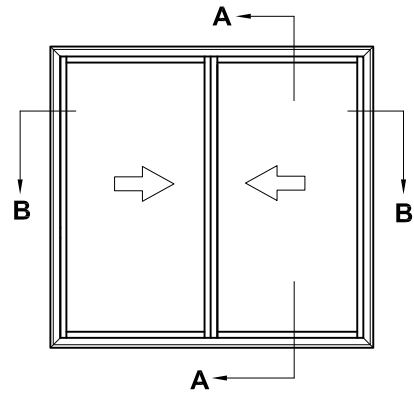
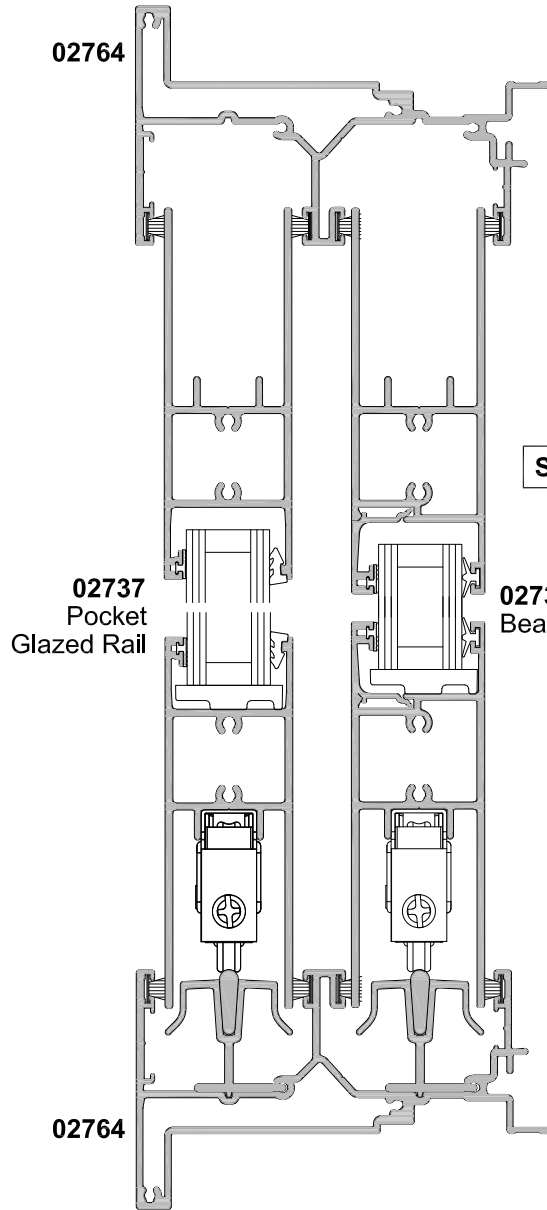

**Note:**  
Not suitable for Extra High Wind Zone and above

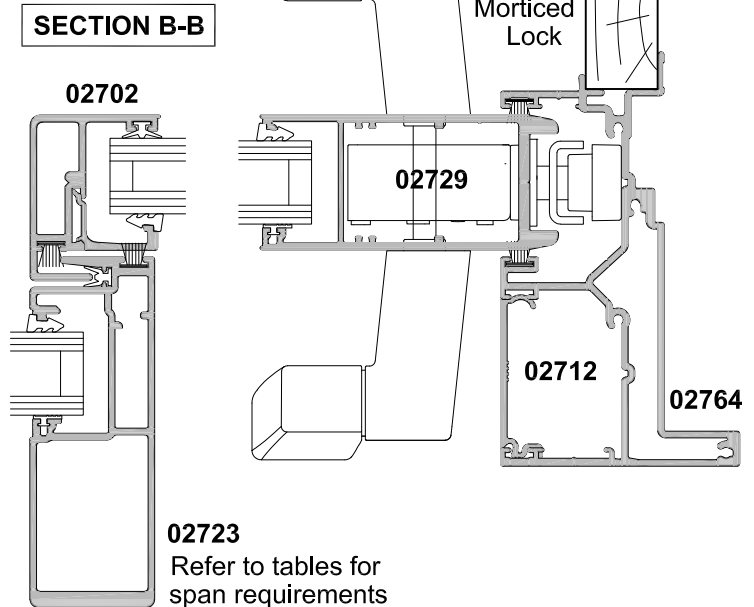
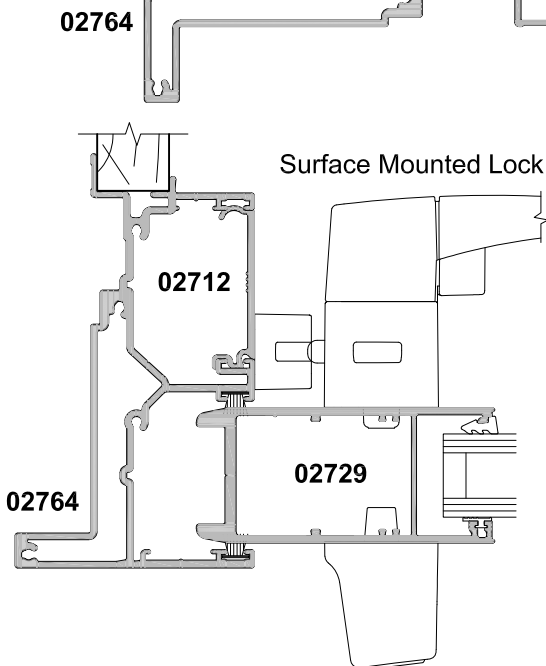

# SLIDING DOOR DUO, THREE PANEL FSS WITH OVERLIGHT TRANSOM CROSS SECTION

Cad Ref. ASD06-0    Scale 1:2    Date 01.04.19

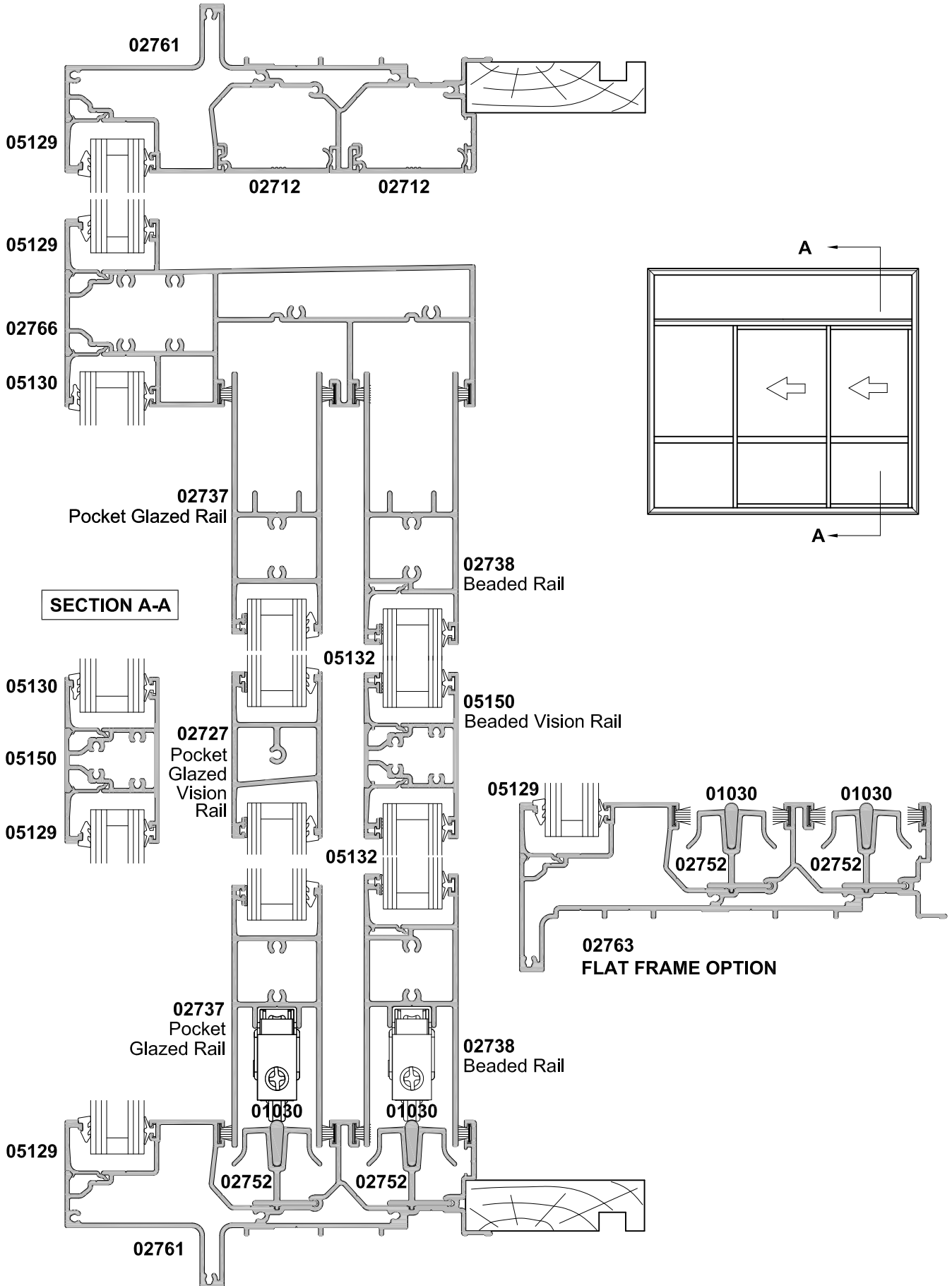

# SLIDING DOOR DUO, THREE PANEL FSS

## CROSS SECTION

Cad Ref. ASD07-0

Scale 1:2

Date 01.04.19

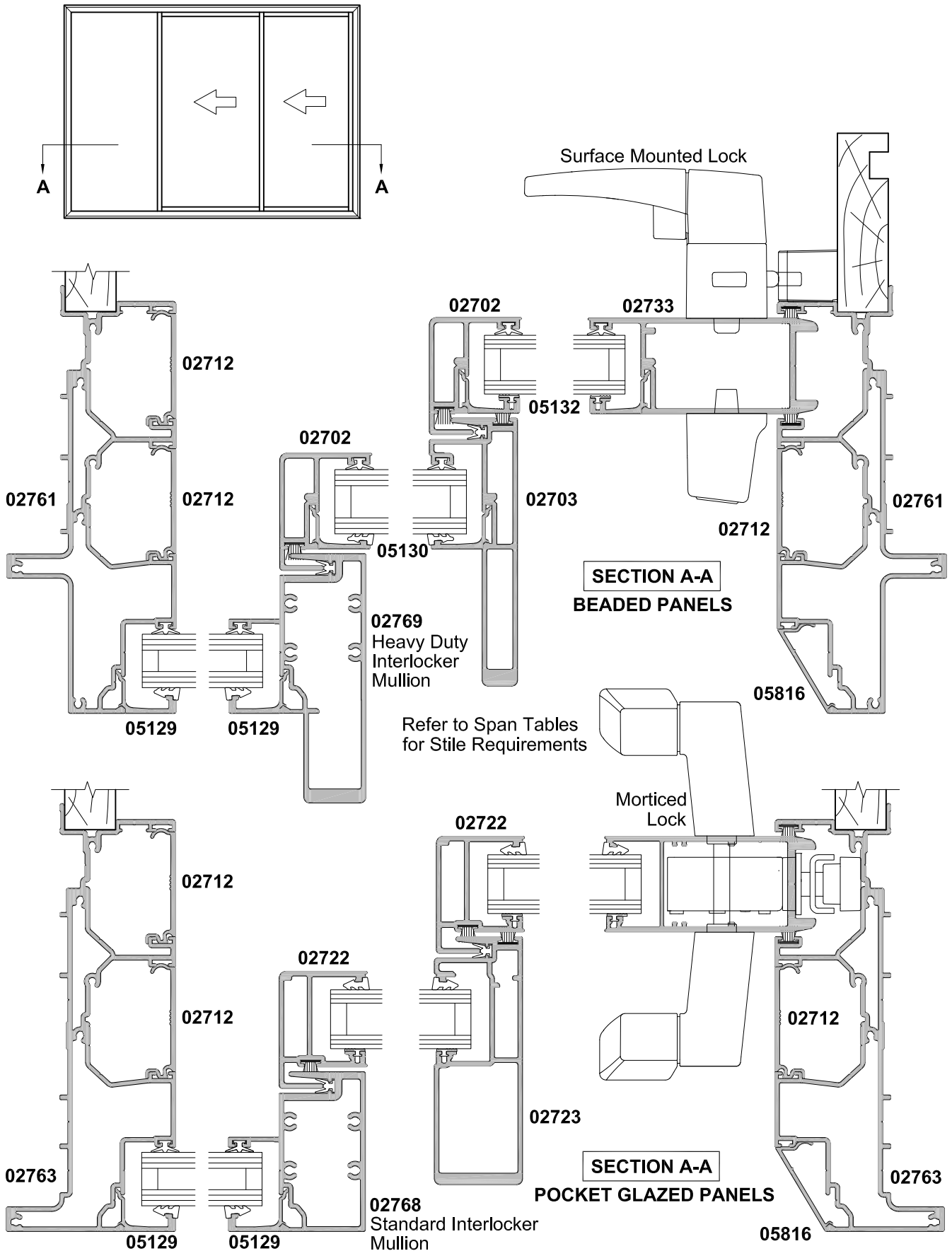

# SLIDING DOOR DUO, FSSSSF

## CROSS SECTION

Cad Ref. ASD08-0    Scale 1:2    Date 01.04.19

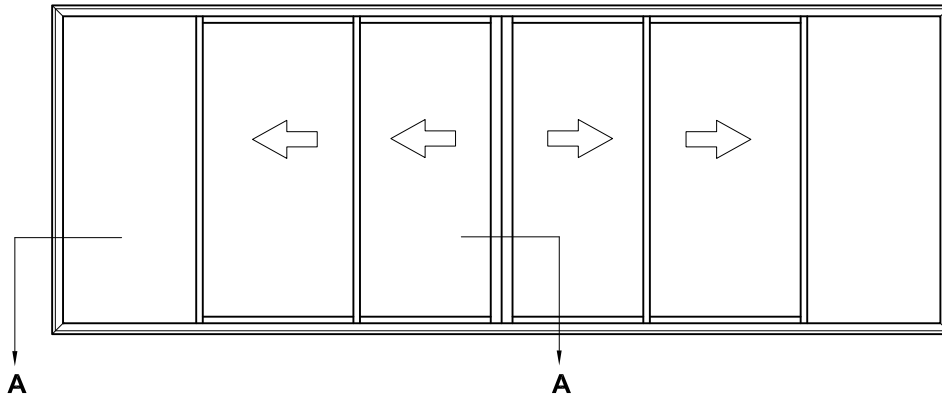

**SECTION A-A**

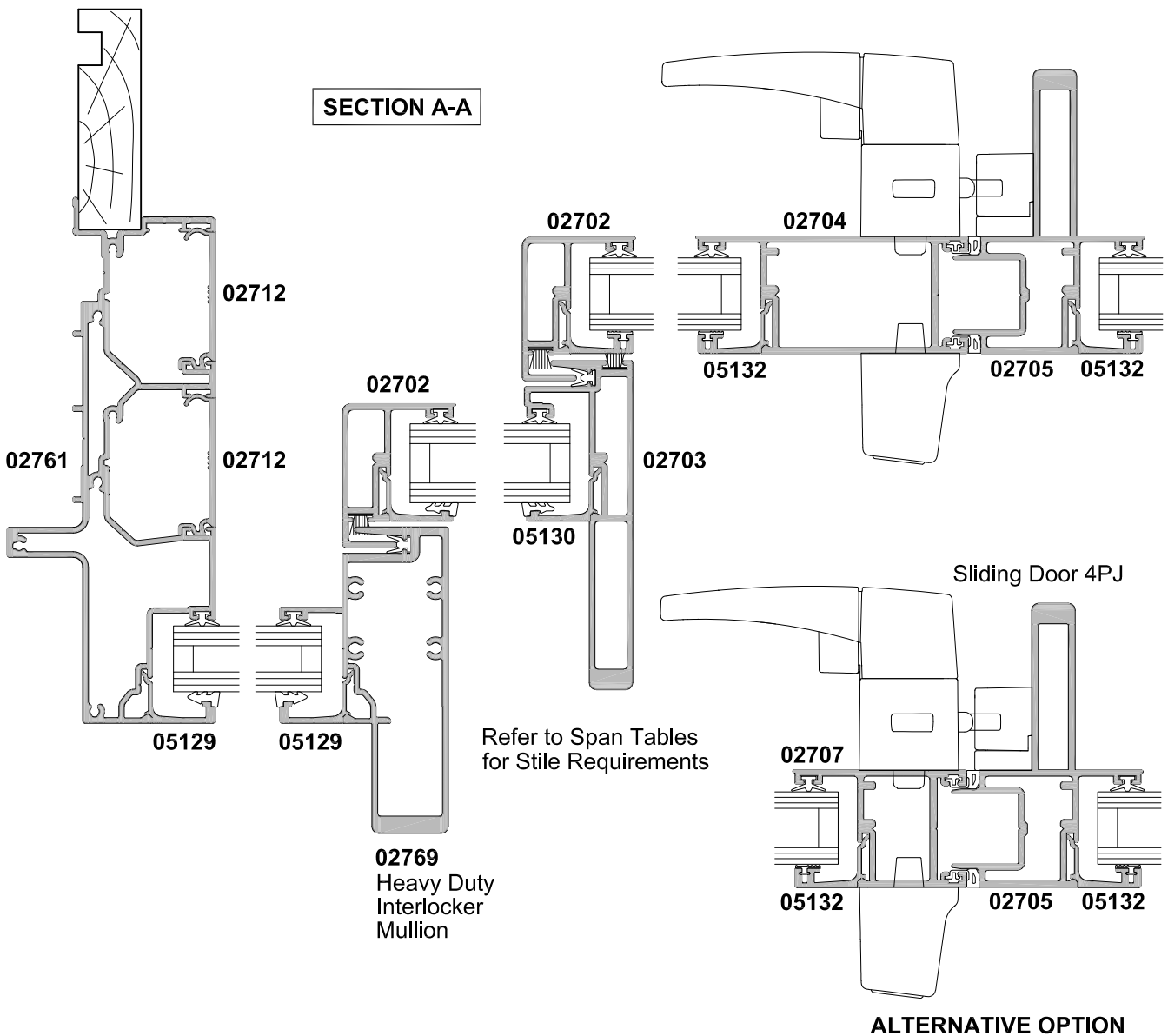



# SLIDING DOOR, FOUR PANEL SSSF

## CROSS SECTION

Cad Ref. ASD09-0

Scale 1:2

Date 01.04.19

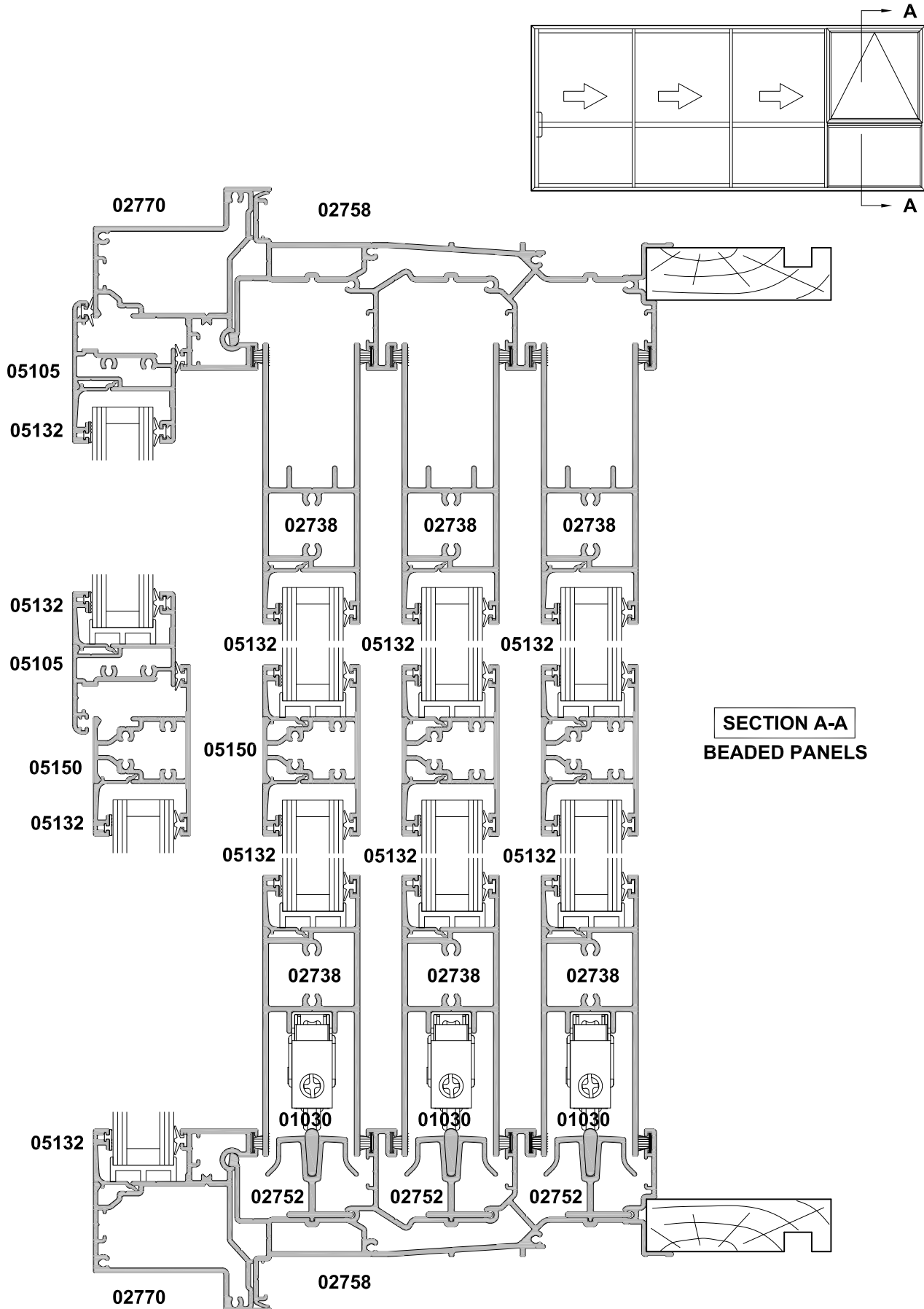

# SLIDING DOOR, FOUR PANEL SSSF

## CROSS SECTION

Cad Ref. ASD10-0

Scale 1:2

Date 01.04.19

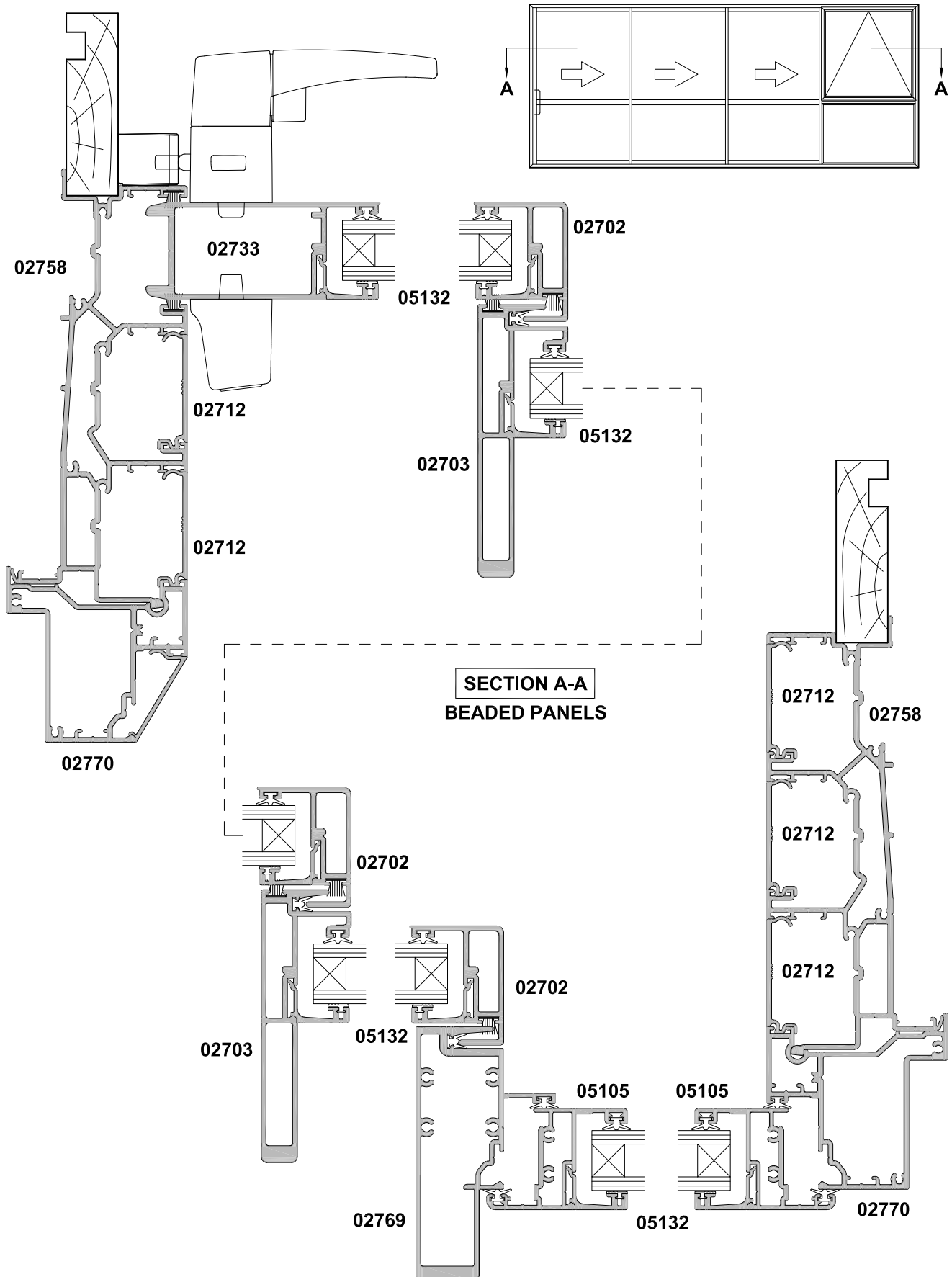

# SLIDING DOOR, 90° CORNERS

## CROSS SECTION

Cad Ref. ASD11-0

Scale 1:2

Date 01.04.19

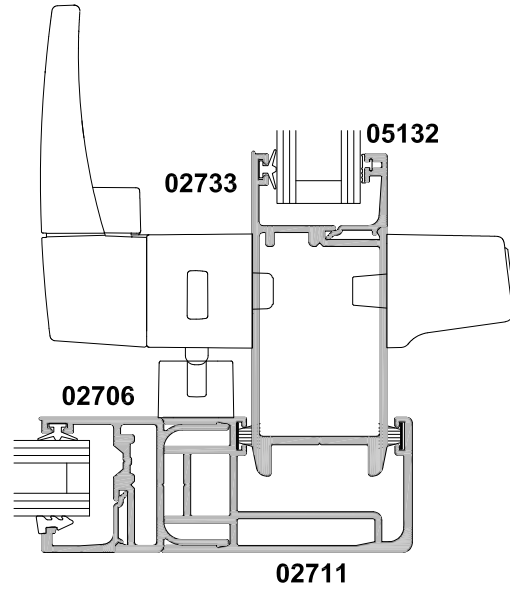
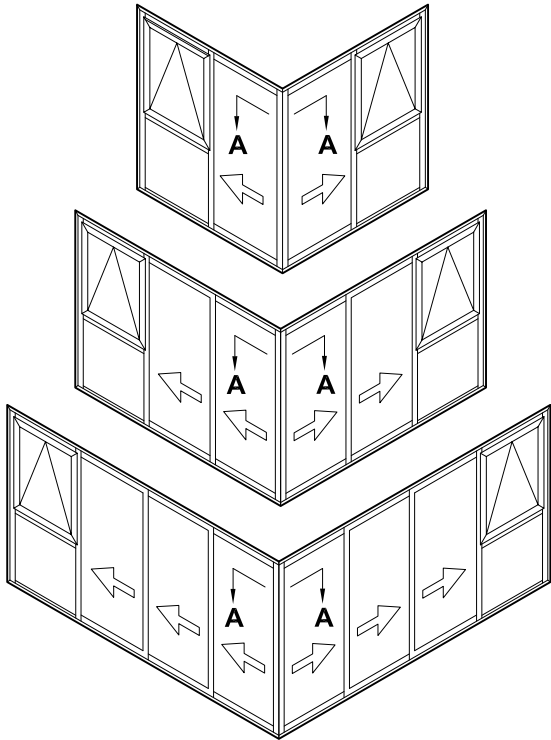

**SECTION A-A**

Beaded Stile Option

**EXTERNAL CORNER**

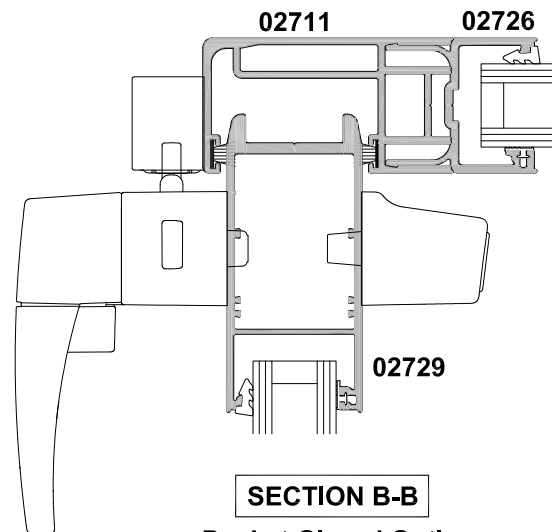
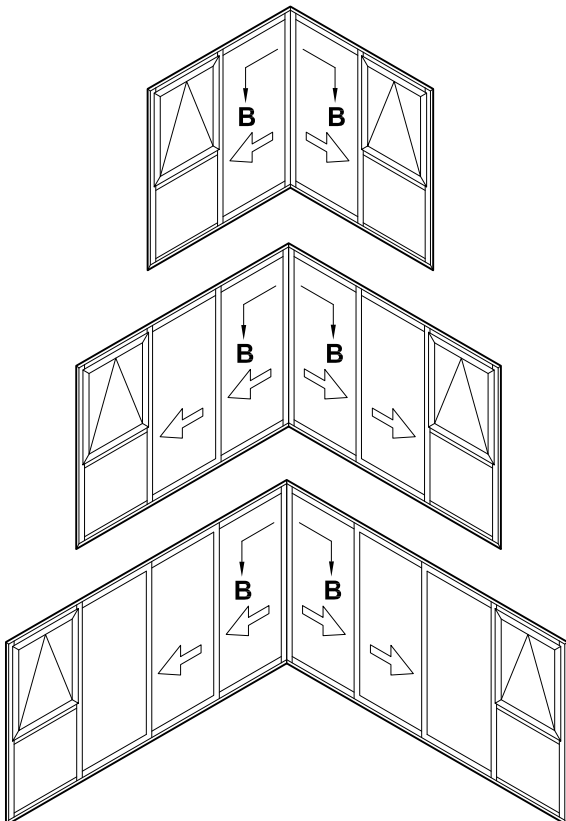

**SECTION B-B**

Pocket Glazed Option

**INTERNAL CORNER**