



# INSTALLATION DETAIL - ARCHITECTURAL THERMAL HEART 171mm AWNING WINDOW ON BEVELBACK WEATHERBOARD CAVITY CONSTRUCTION

Date: 01.09.23

Scale: 1:2

CAD Ref.: TA171AWBW-CH

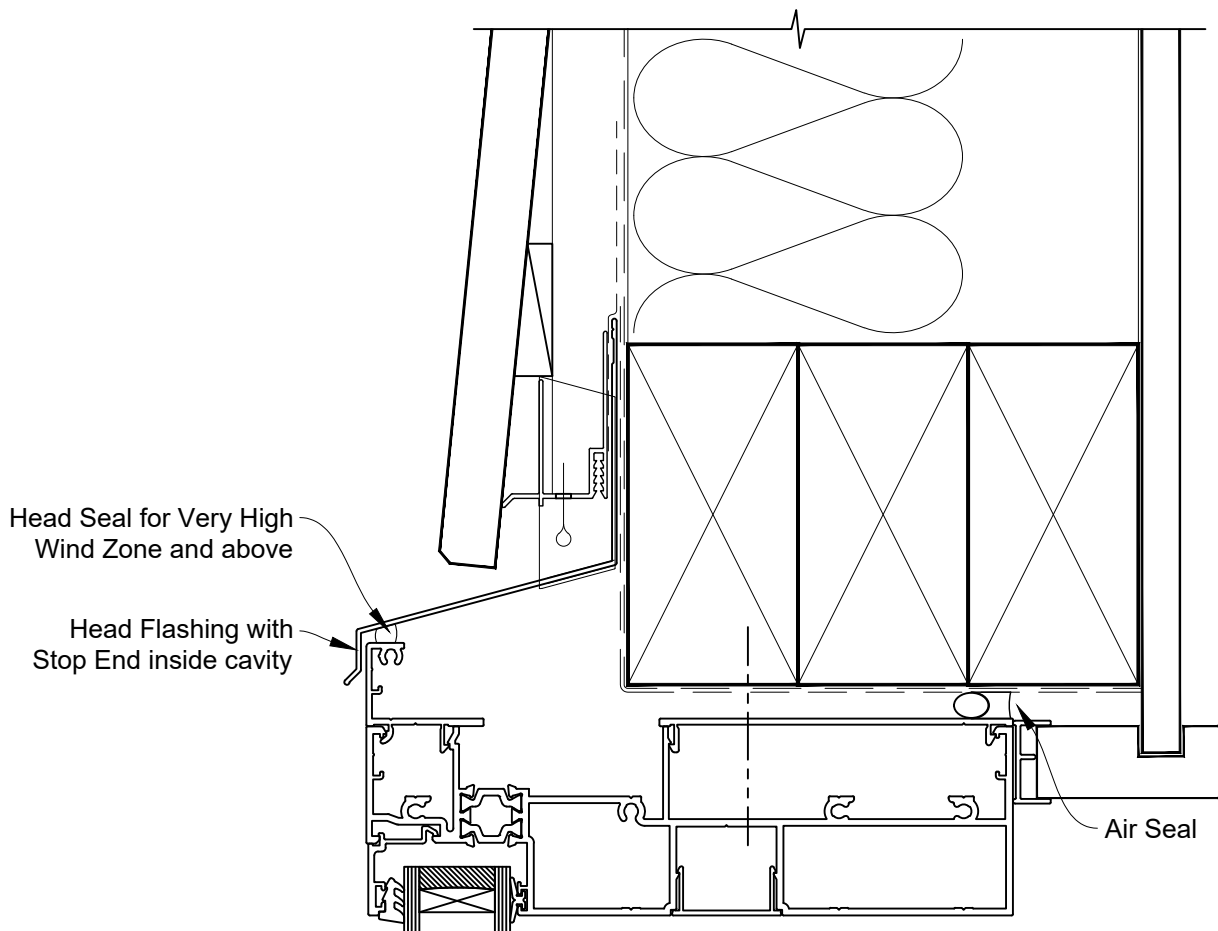



# INSTALLATION DETAIL - ARCHITECTURAL THERMAL HEART 171mm AWNING WINDOW ON BEVELBACK WEATHERBOARD CAVITY CONSTRUCTION

Date: 01.09.23

Scale: 1:2

CAD Ref.: TA171AWBW-CJ

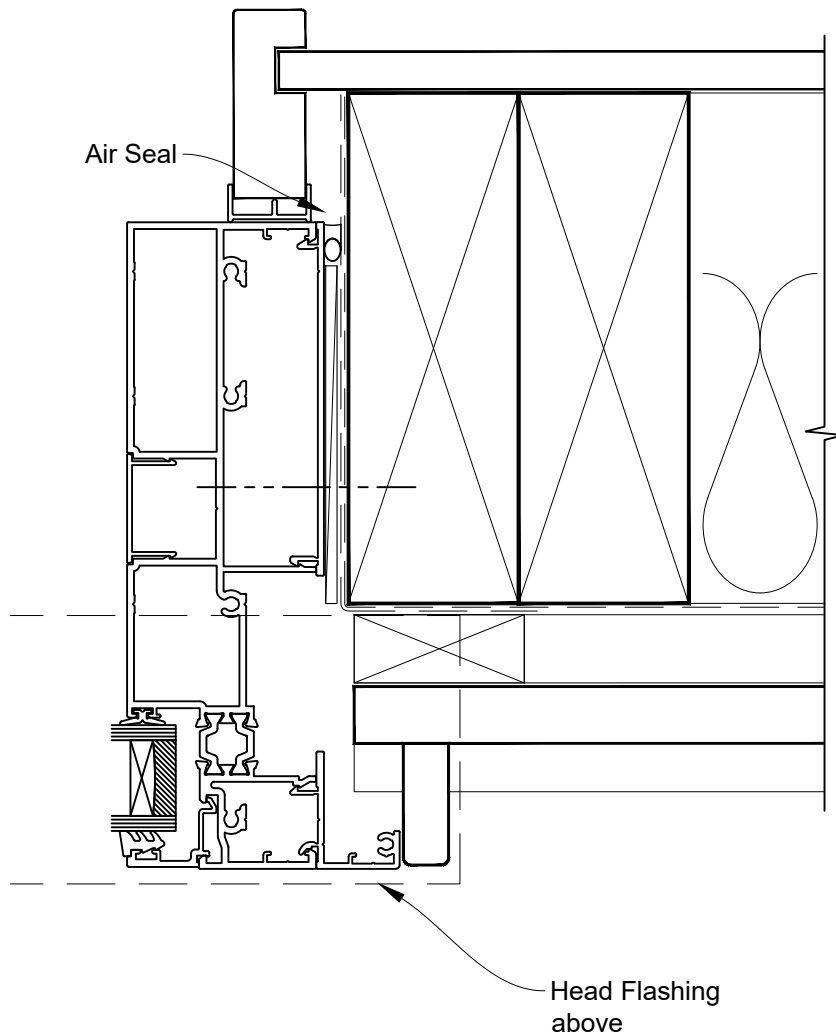



# INSTALLATION DETAIL - ARCHITECTURAL THERMAL HEART 171mm AWNING WINDOW ON BEVELBACK WEATHERBOARD CAVITY CONSTRUCTION

Date: 01.09.23

Scale: 1:2

CAD Ref.: TA171AWBW-CS

## FACING INFILL OPTION

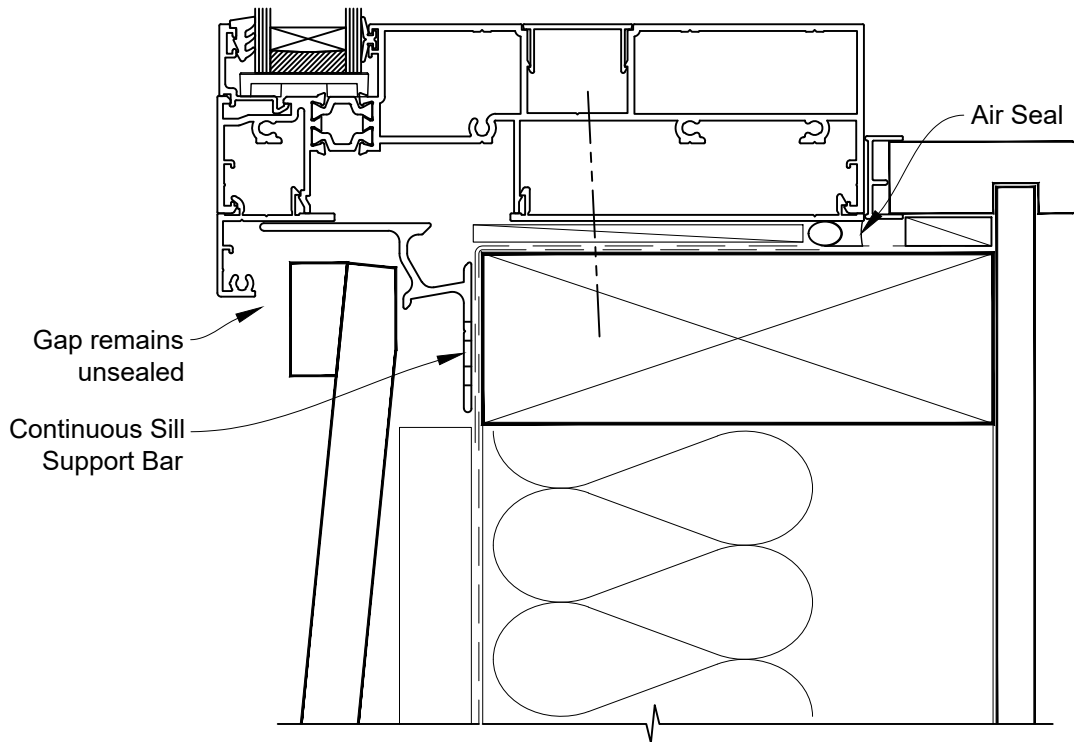



# INSTALLATION DETAIL - ARCHITECTURAL THERMAL HEART 171mm AWNING WINDOW ON BEVELBACK WEATHERBOARD CAVITY CONSTRUCTION

Date: 01.09.23

Scale: 1:2

CAD Ref.: TA171AWBW-CS2

## SILL TRAY OPTION

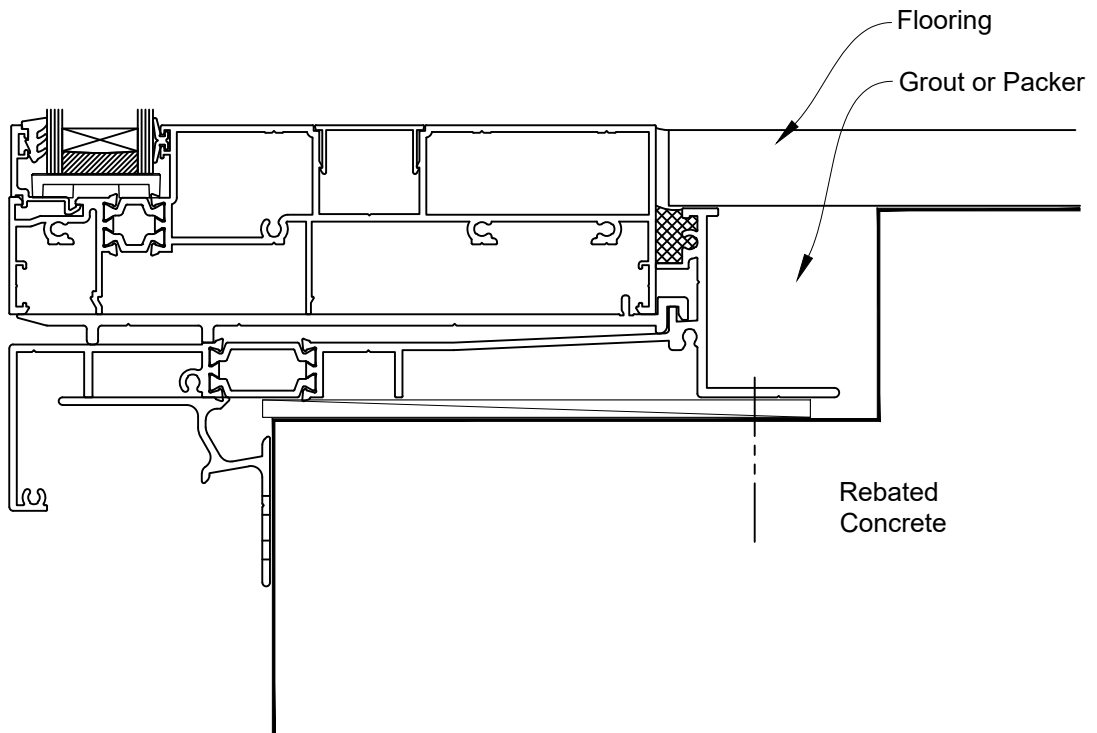



# INSTALLATION DETAIL - ARCHITECTURAL THERMAL HEART 171mm AWNING WINDOW ON BEVELBACK WEATHERBOARD CAVITY CONSTRUCTION

Date: 01.09.23

Scale: 1:2

CAD Ref.: TA171AWBW-CS3

## SILL TRAY OPTION

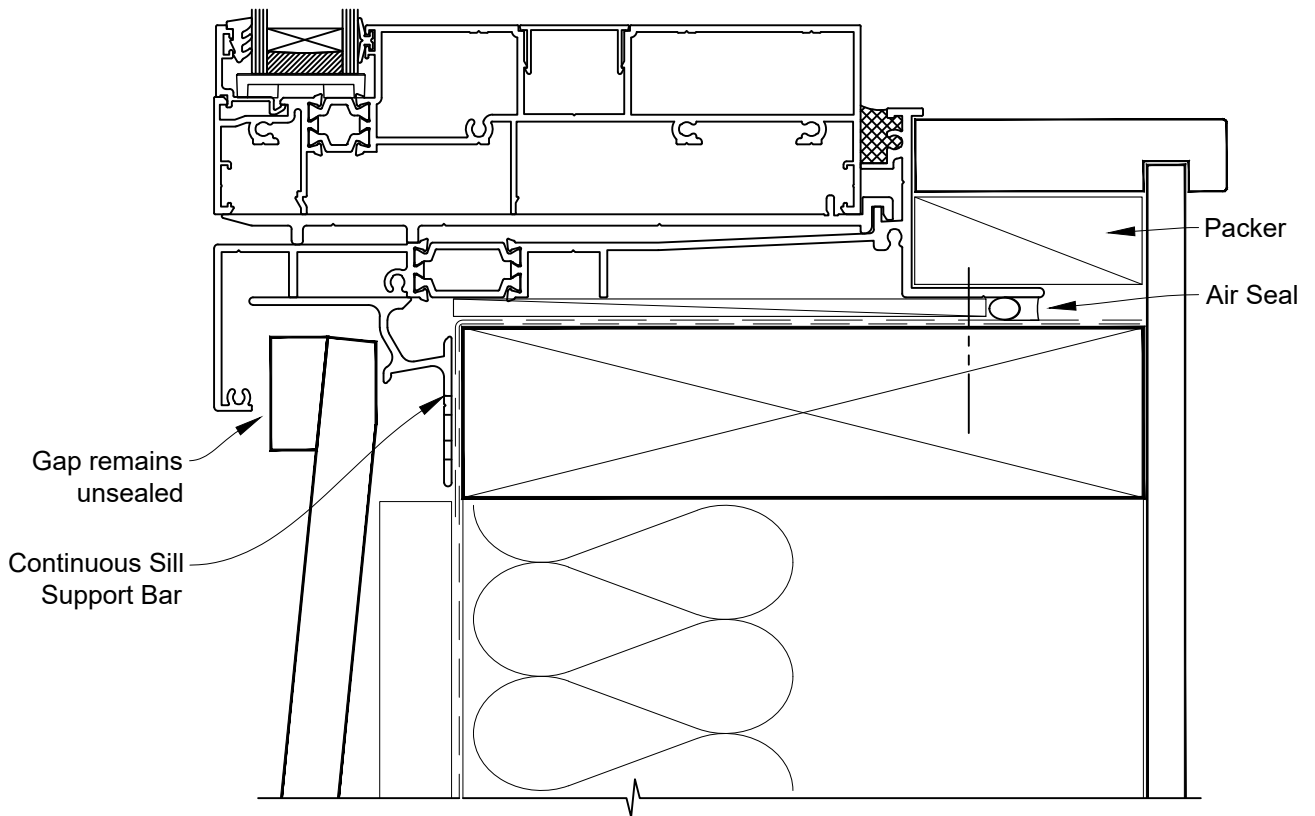



# INSTALLATION DETAIL - ARCHITECTURAL THERMAL HEART 171mm AWNING WINDOW ON BEVELBACK WEATHERBOARD DIRECT FIXED CLADDING

Date: 01.09.23

Scale: 1:2

CAD Ref.: TA171AWBW-DH

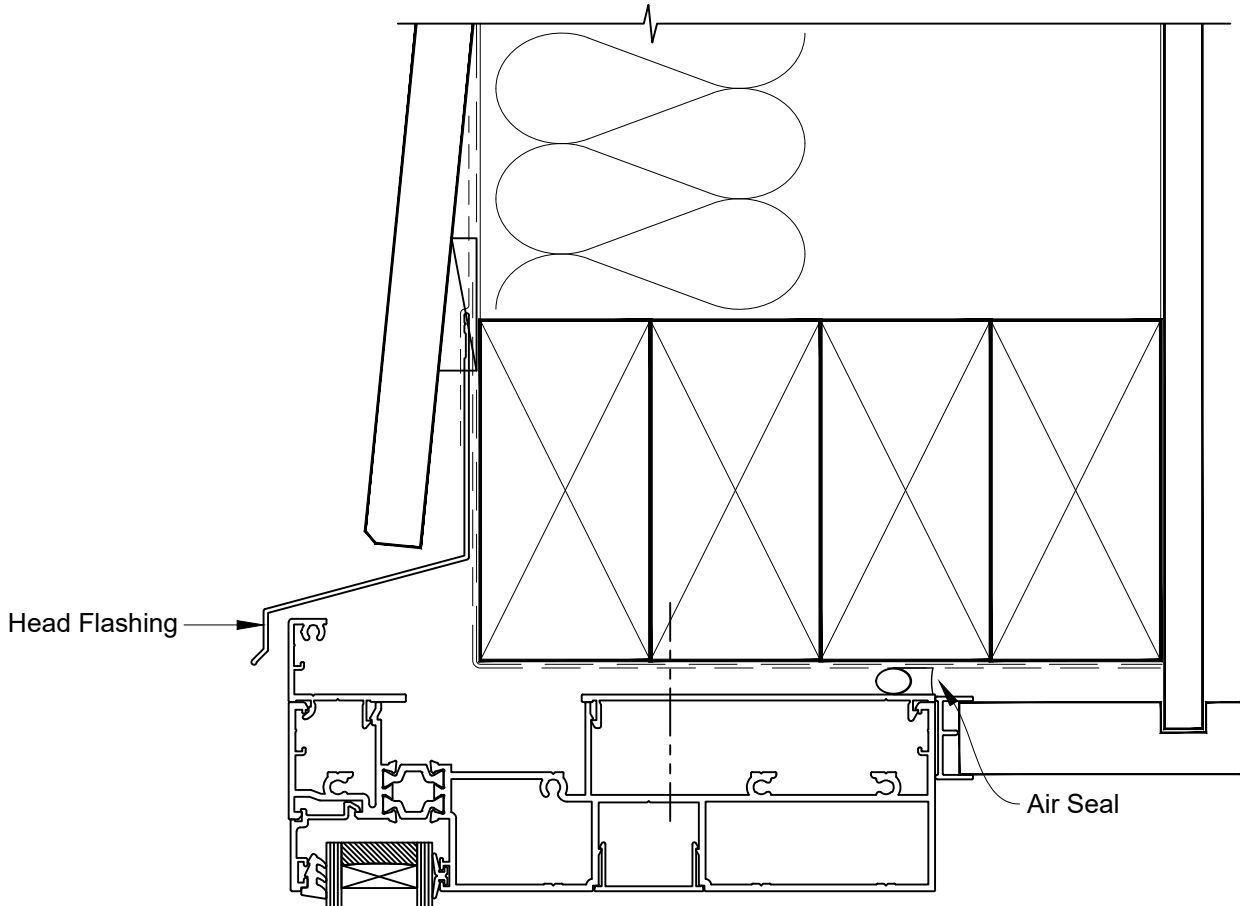



# INSTALLATION DETAIL - ARCHITECTURAL THERMAL HEART 171mm AWNING WINDOW ON BEVELBACK WEATHERBOARD DIRECT FIXED CLADDING

Date: 01.09.23

Scale: 1:2

CAD Ref.: TA171AWBW-DJ

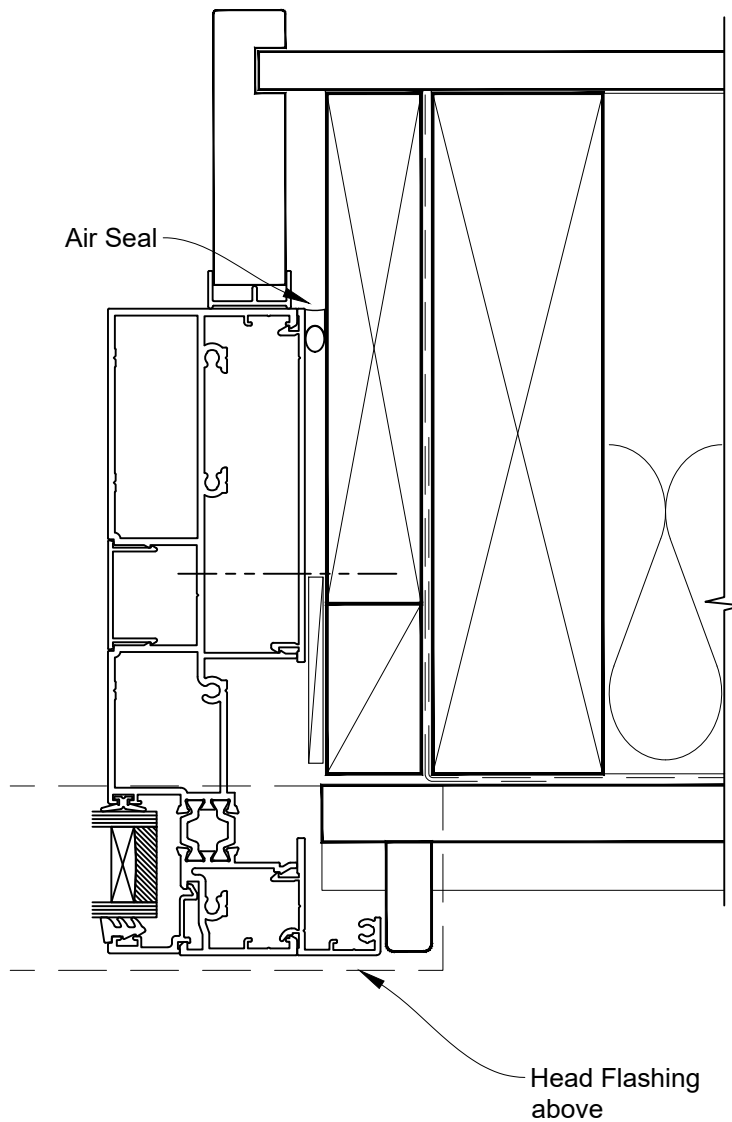



# INSTALLATION DETAIL - ARCHITECTURAL THERMAL HEART 171mm AWNING WINDOW ON BEVELBACK WEATHERBOARD DIRECT FIXED CLADDING

Date: 01.09.23

Scale: 1:2

CAD Ref.: TA171AWBW-DS

## SILL TRAY OPTION

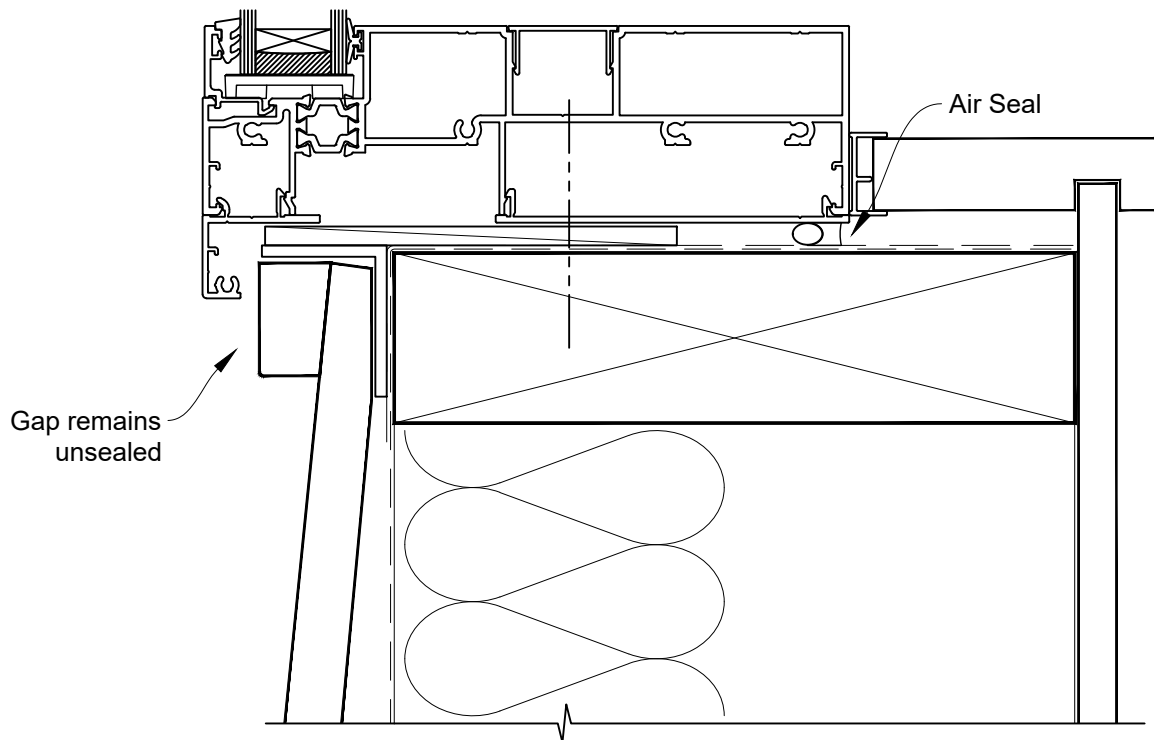





# INSTALLATION DETAIL - ARCHITECTURAL THERMAL HEART 171mm AWNING WINDOW ON BEVELBACK WEATHERBOARD DIRECT FIXED CLADDING

Date: 01.09.23

Scale: 1:2

CAD Ref.: TA171AWBW-DS2

## FACING INFILL OPTION

