



INSTALLATION DETAIL - ARCHITECTURAL THERMAL HEART 171mm SLIDING DOOR ON BOARD & BATTEN CAVITY CONSTRUCTION

Date: 01.09.23

Scale: 1:2

CAD Ref.: TA171SDBB-CH

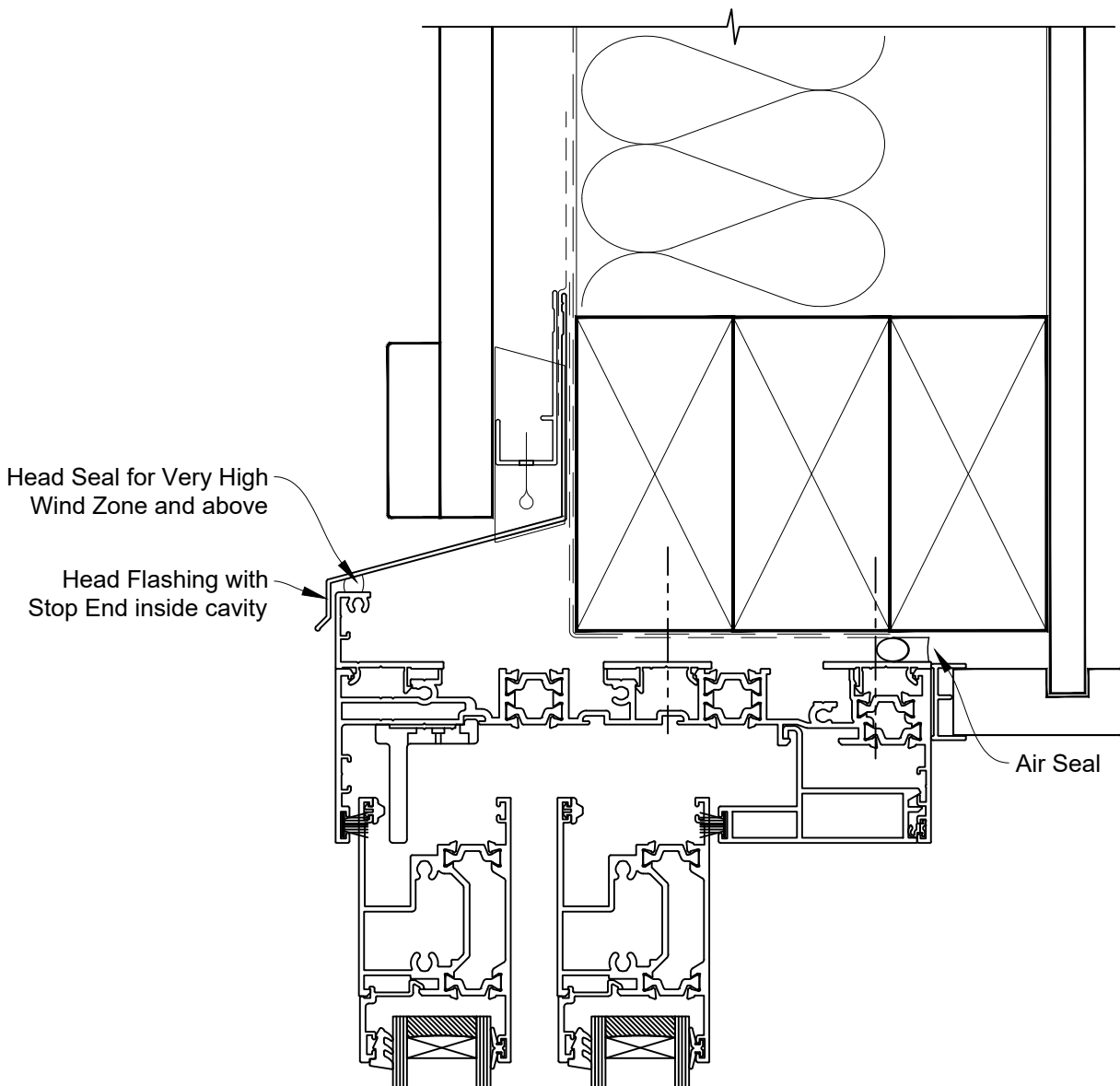



INSTALLATION DETAIL - ARCHITECTURAL THERMAL HEART 171mm SLIDING DOOR ON BOARD & BATTEN CAVITY CONSTRUCTION

Date: 01.09.23

Scale: 1:2

CAD Ref.: TA171SDBB-CJ

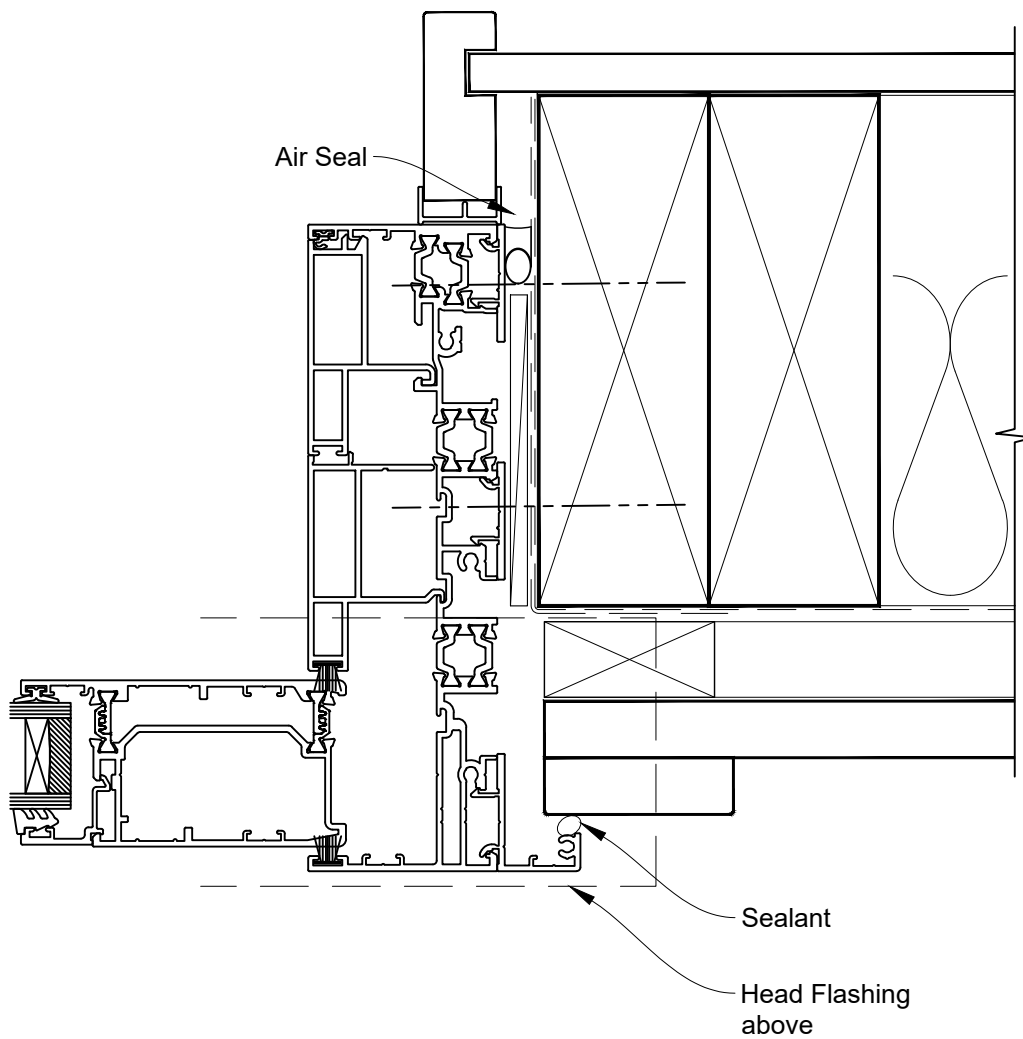



INSTALLATION DETAIL - ARCHITECTURAL THERMAL HEART 171mm SLIDING DOOR ON BOARD & BATTEN CAVITY CONSTRUCTION

Date: 01.09.23

Scale: 1:2

CAD Ref.: TA171SDBB-CS

FACING INFILL OPTION

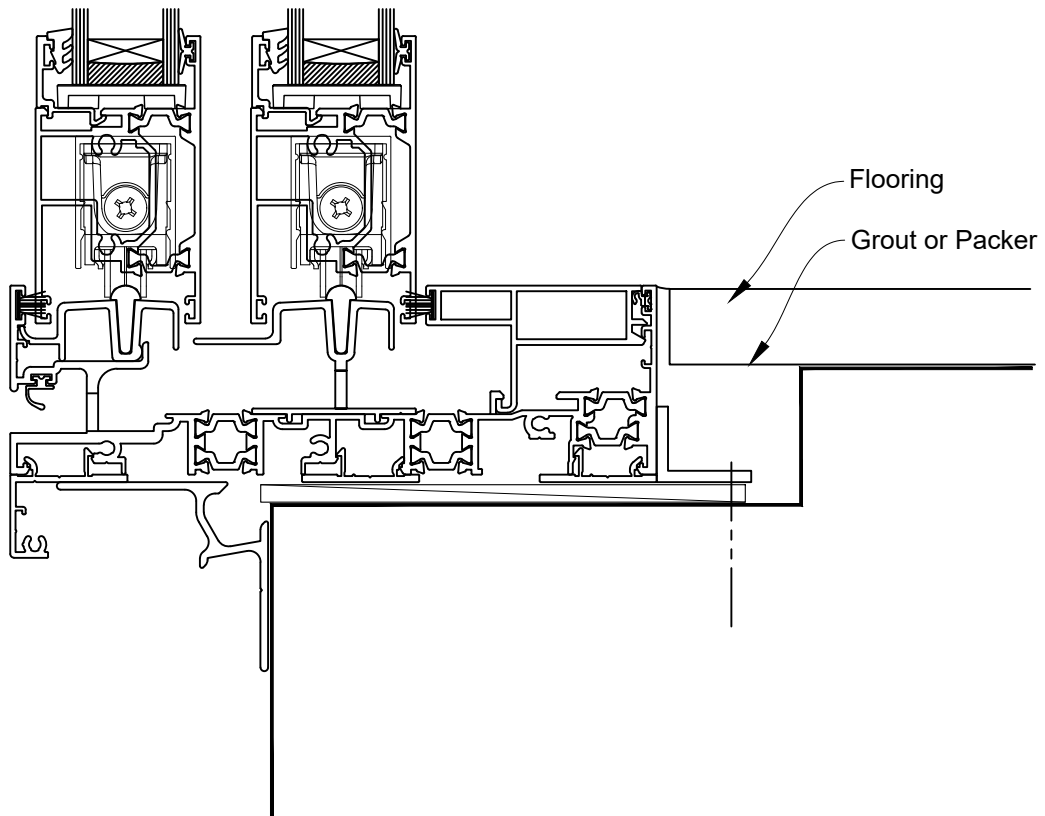



INSTALLATION DETAIL - ARCHITECTURAL THERMAL HEART 171mm SLIDING DOOR ON BOARD & BATTEN CAVITY CONSTRUCTION

Date: 01.09.23

Scale: 1:2

CAD Ref.: TA171SDBB-CS2

SILL TRAY OPTION

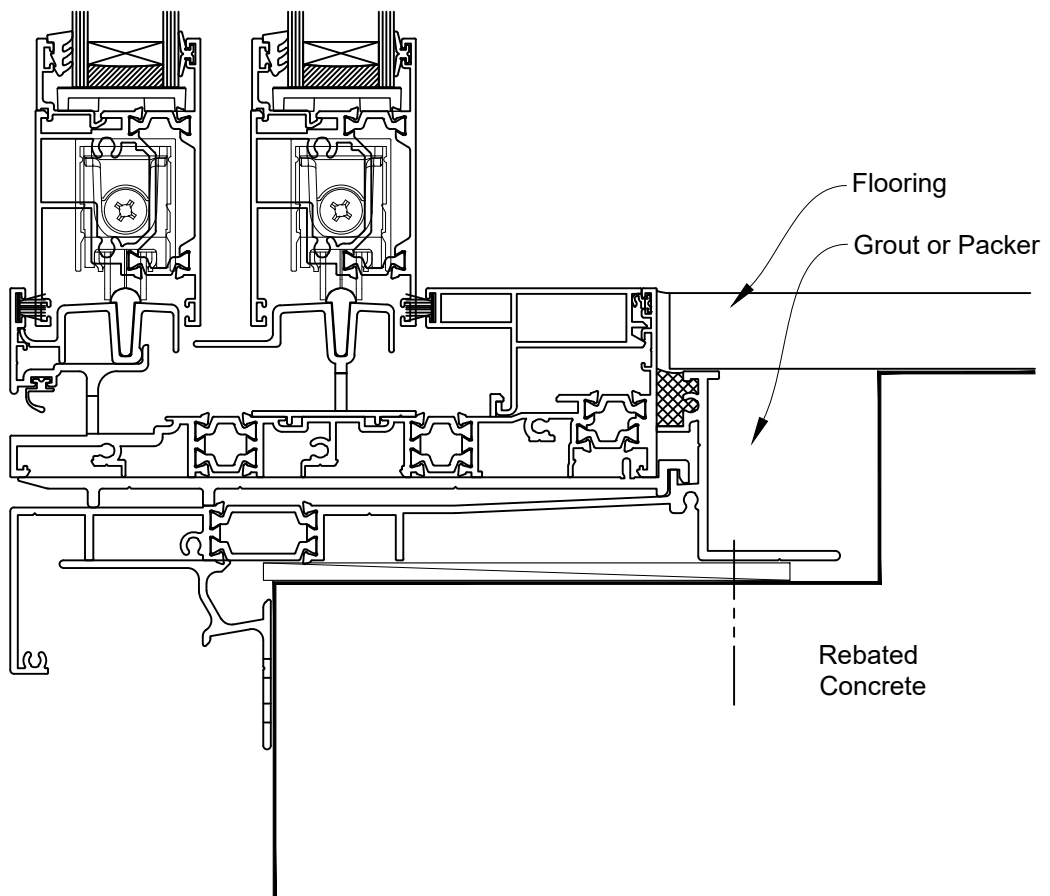



INSTALLATION DETAIL - ARCHITECTURAL THERMAL HEART 171mm SLIDING DOOR ON BOARD & BATTEN DIRECT FIXED CLADDING

Date: 01.09.23

Scale: 1:2

CAD Ref.: TA171SDBB-DH

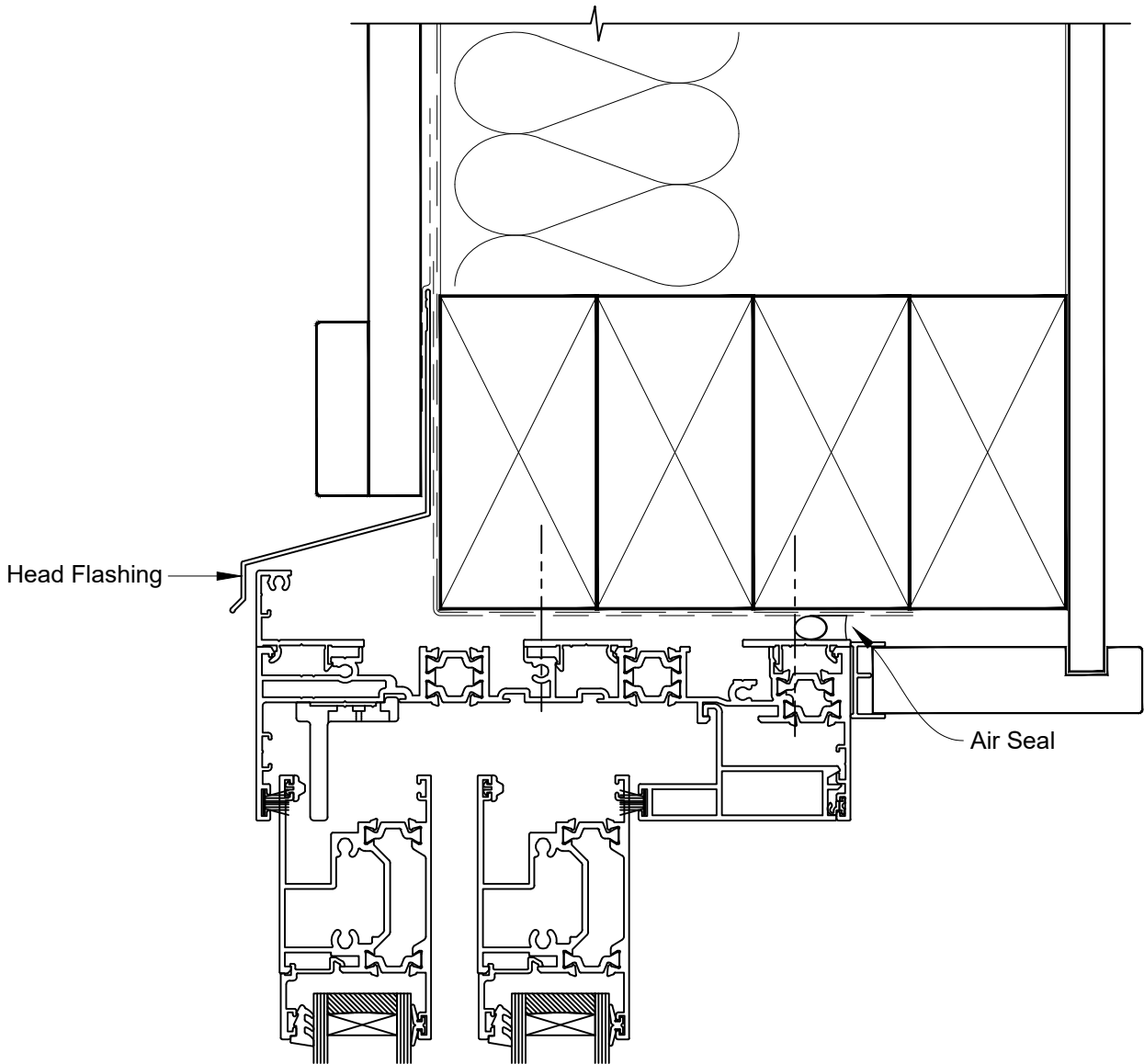



INSTALLATION DETAIL - ARCHITECTURAL THERMAL HEART 171mm SLIDING DOOR ON BOARD & BATTEN DIRECT FIXED CLADDING

Date: 01.09.23

Scale: 1:2

CAD Ref.: TA171SDBB-DJ

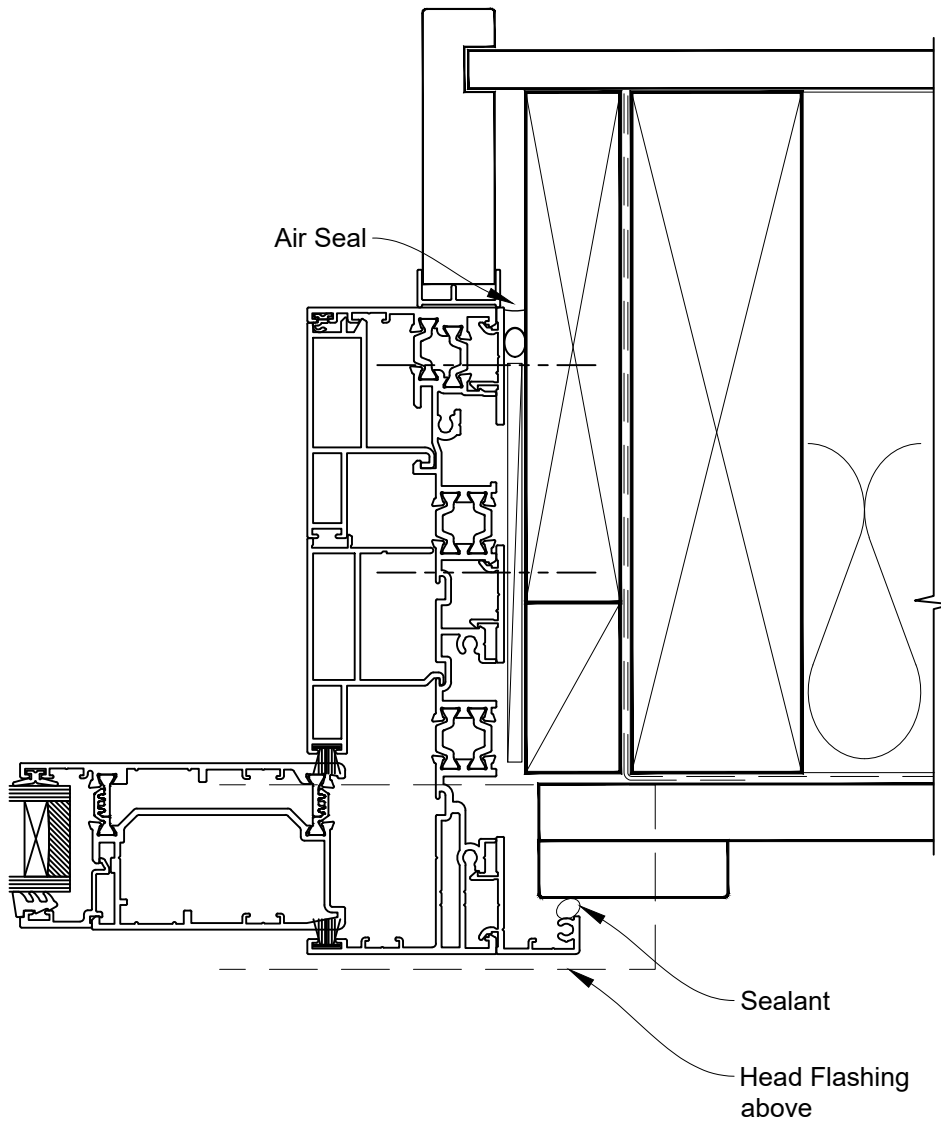



INSTALLATION DETAIL - ARCHITECTURAL THERMAL HEART 171mm SLIDING DOOR ON BOARD & BATTEN DIRECT FIXED CLADDING

Date: 01.09.23

Scale: 1:2

CAD Ref.: TA171SDBB-DS

FACING INFILL OPTION

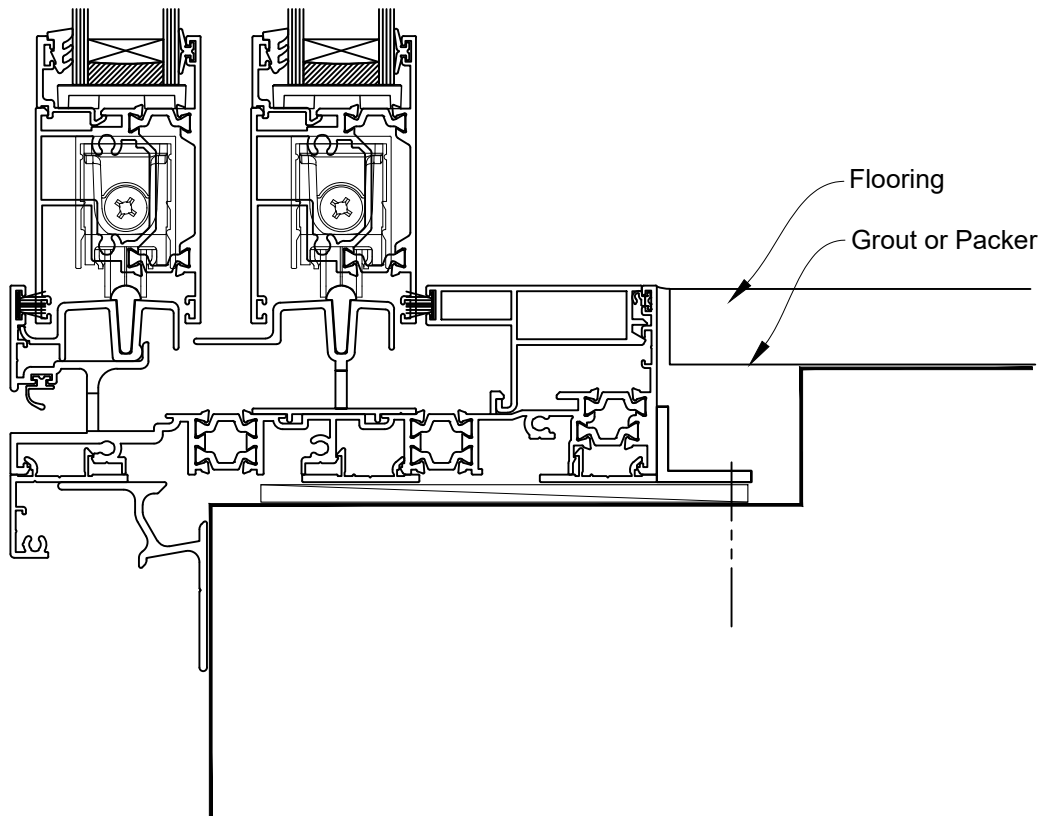



INSTALLATION DETAIL - ARCHITECTURAL THERMAL HEART 171mm SLIDING DOOR ON BOARD & BATTEN DIRECT FIXED CLADDING

Date: 01.09.23

Scale: 1:2

CAD Ref.: TA171SDBB-DS2

SILL TRAY OPTION

