



# INSTALLATION DETAIL - RESIDENTIAL THERMAL HEART BIFOLD DOOR OPEN OUT ON RUSTICATED WEATHERBOARD CAVITY CONSTRUCTION

Date: 01.01.23

Scale: 1:2

CAD Ref.: TRBDRW-CH

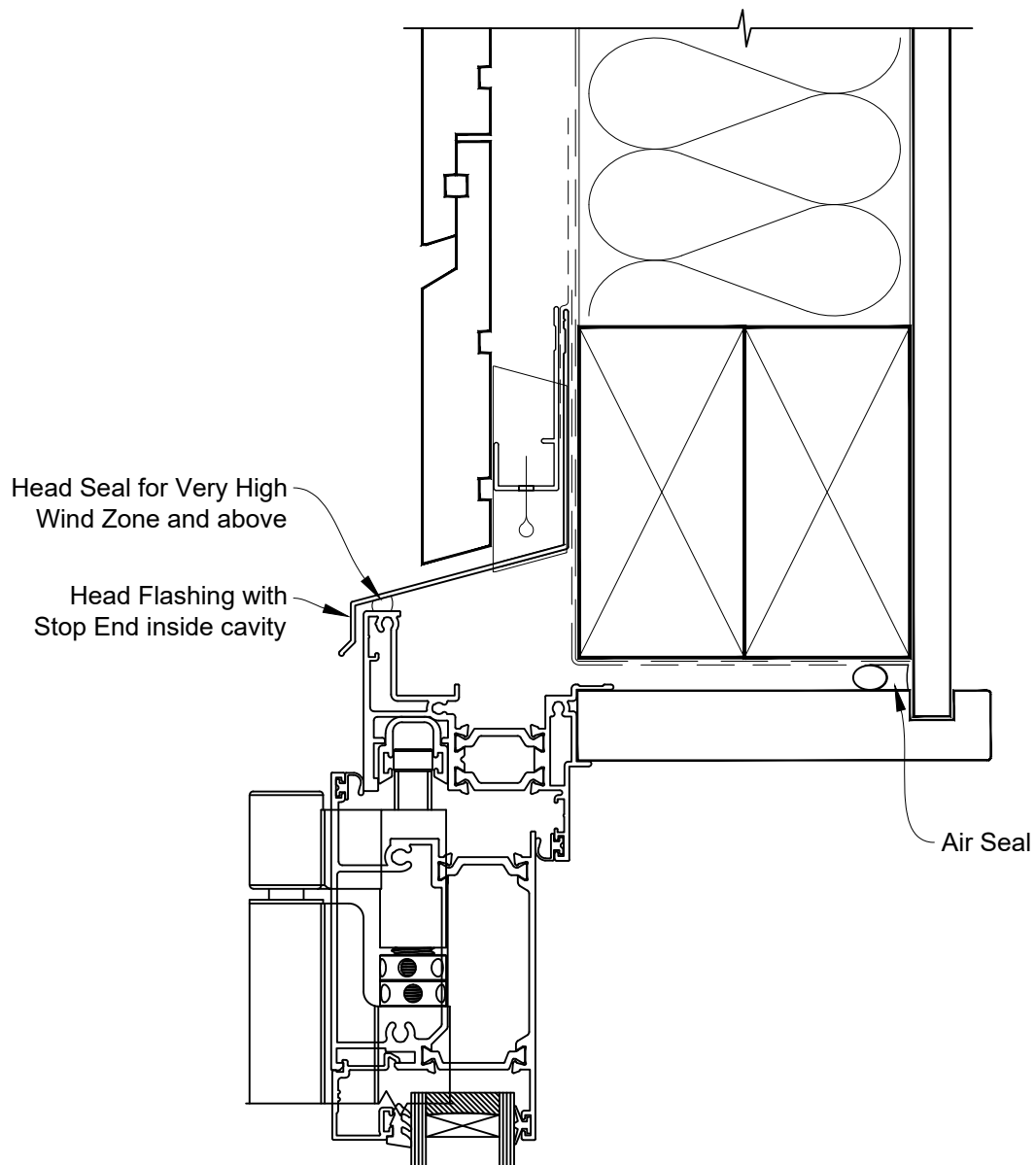



# INSTALLATION DETAIL - RESIDENTIAL THERMAL HEART BIFOLD DOOR OPEN OUT ON RUSTICATED WEATHERBOARD CAVITY CONSTRUCTION

Date: 01.01.23

Scale: 1:2

CAD Ref.: TRBDRW-CJ

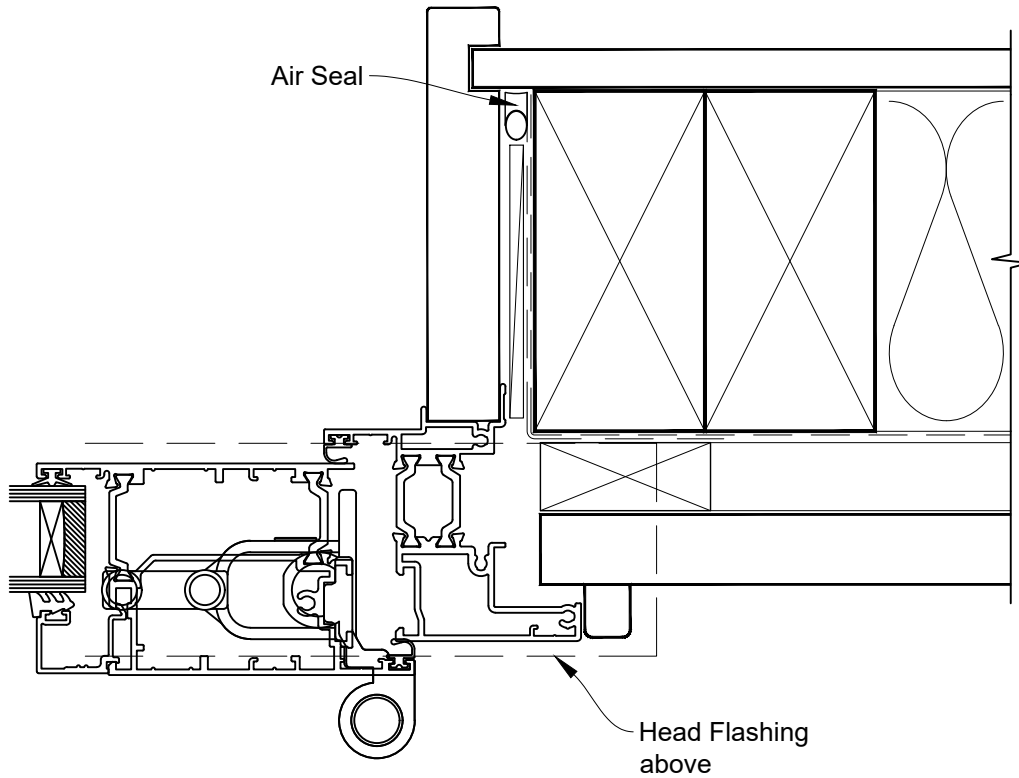



# INSTALLATION DETAIL - RESIDENTIAL THERMAL HEART BIFOLD DOOR OPEN OUT ON RUSTICATED WEATHERBOARD CAVITY CONSTRUCTION

Date: 01.01.23

Scale: 1:2

CAD Ref.: TRBDRW-CS

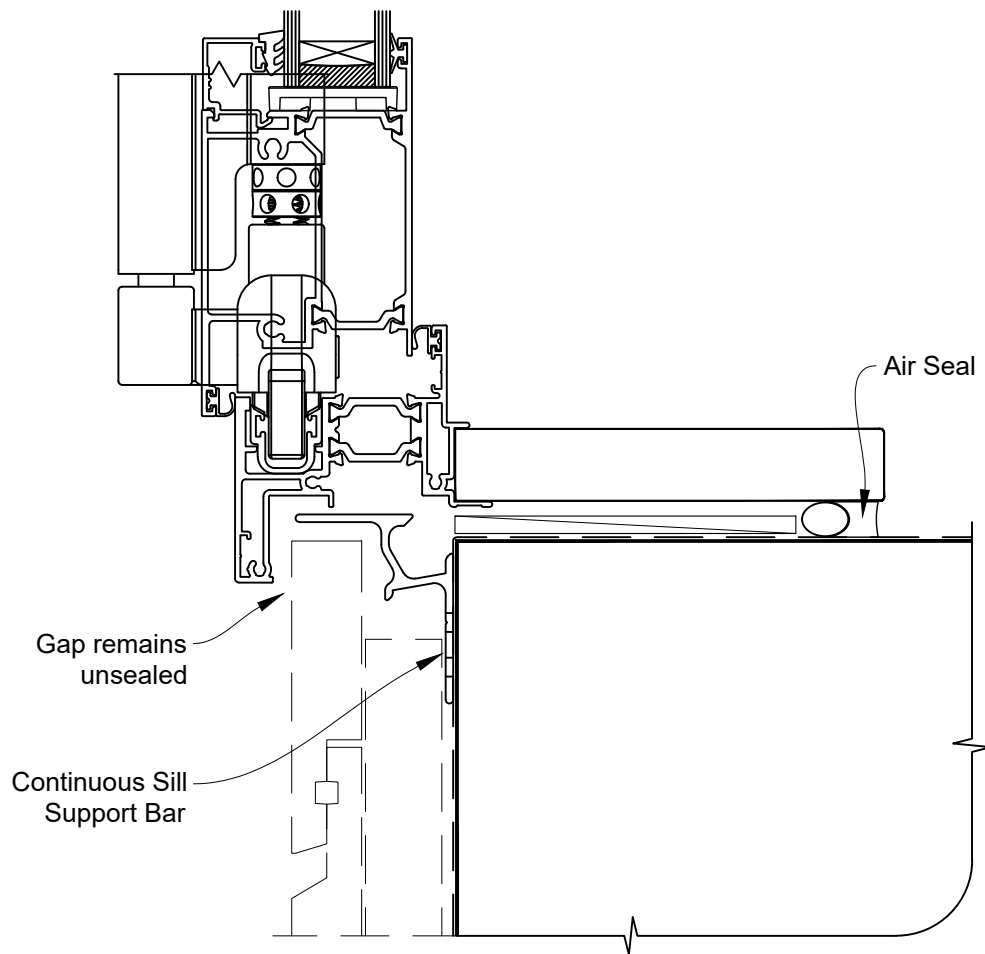



# INSTALLATION DETAIL - RESIDENTIAL THERMAL HEART BIFOLD DOOR OPEN OUT ON RUSTICATED WEATHERBOARD DIRECT FIXED CLADDING

Date: 01.01.23

Scale: 1:2

CAD Ref.: TRBDRW-DH

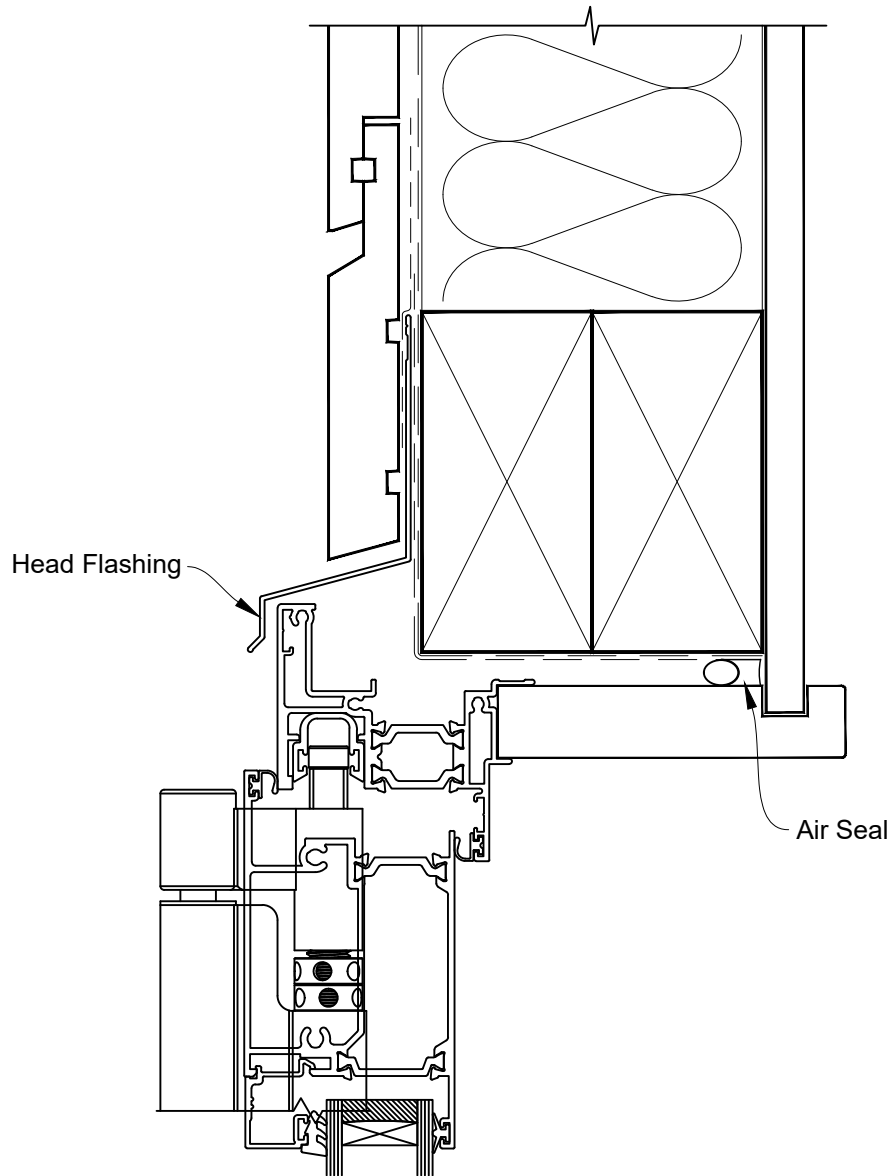



# INSTALLATION DETAIL - RESIDENTIAL THERMAL HEART BIFOLD DOOR OPEN OUT ON RUSTICATED WEATHERBOARD DIRECT FIXED CLADDING

Date: 01.01.23

Scale: 1:2

CAD Ref.: TRBDRW-DJ

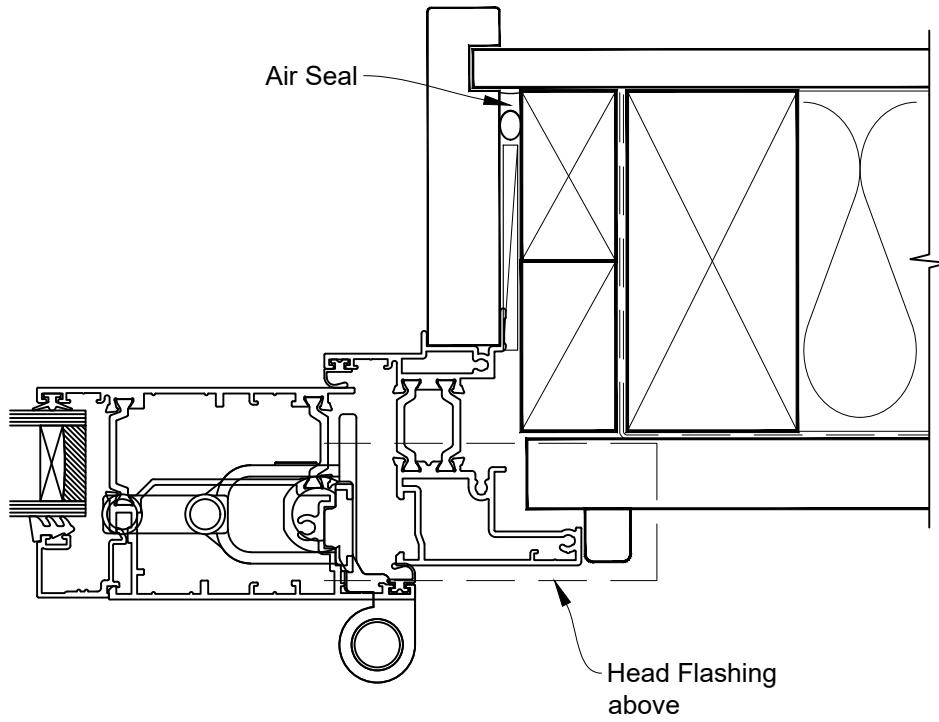



# INSTALLATION DETAIL - RESIDENTIAL THERMAL HEART BIFOLD DOOR OPEN OUT ON RUSTICATED WEATHERBOARD DIRECT FIXED CLADDING

Date: 01.01.23

Scale: 1:2

CAD Ref.: TRBDRW-DS

