



INSTALLATION DETAIL - RESIDENTIAL THERMAL HEART BIFOLD DOOR OPEN OUT ON FLAT SHEET CAVITY CONSTRUCTION

Date: 01.01.23

Scale: 1:2

CAD Ref.: TRBDFS-CH

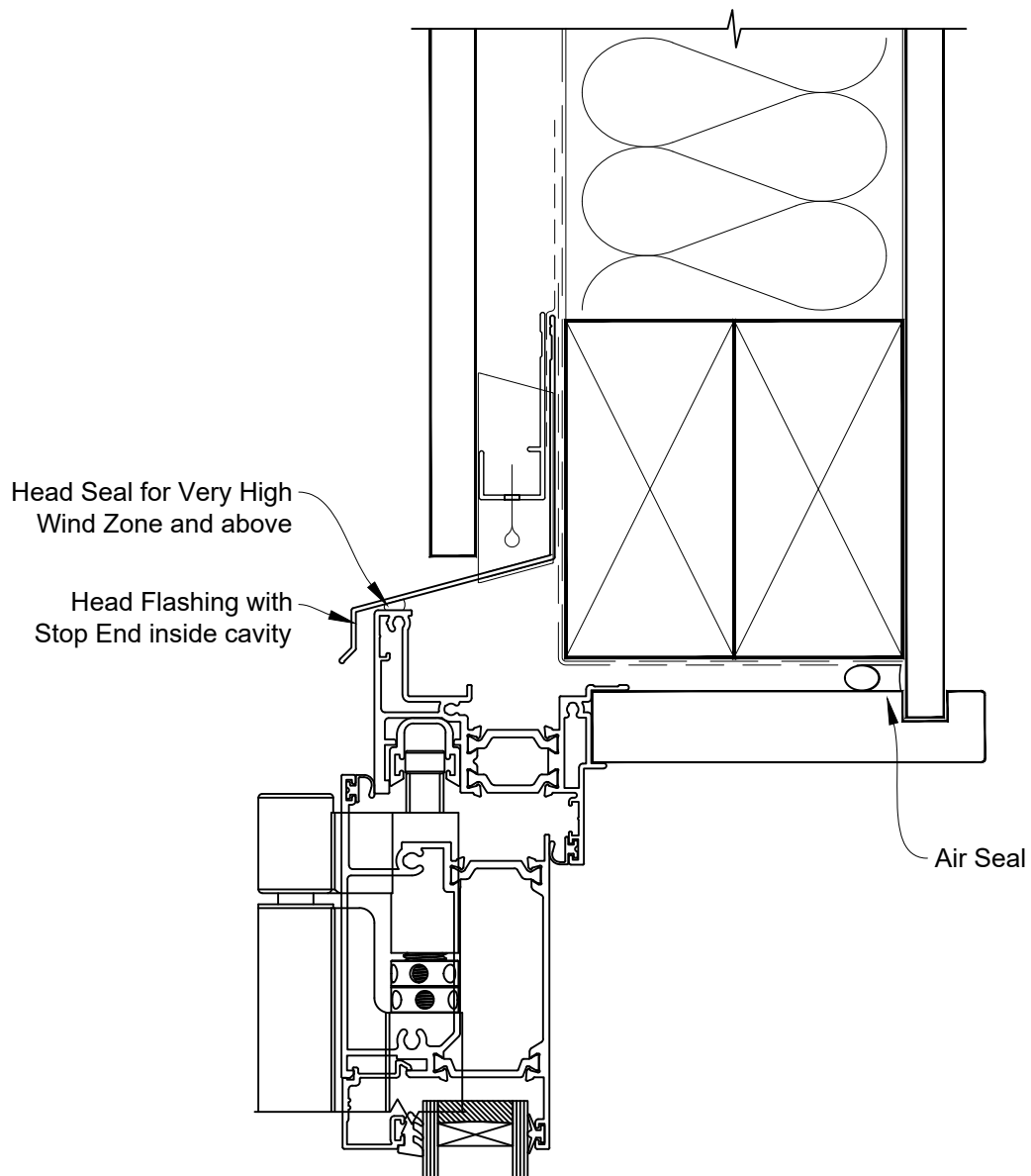



INSTALLATION DETAIL - RESIDENTIAL THERMAL HEART BIFOLD DOOR OPEN OUT ON FLAT SHEET CAVITY CONSTRUCTION

Date: 01.01.23

Scale: 1:2

CAD Ref.: TRBDFS-CJ

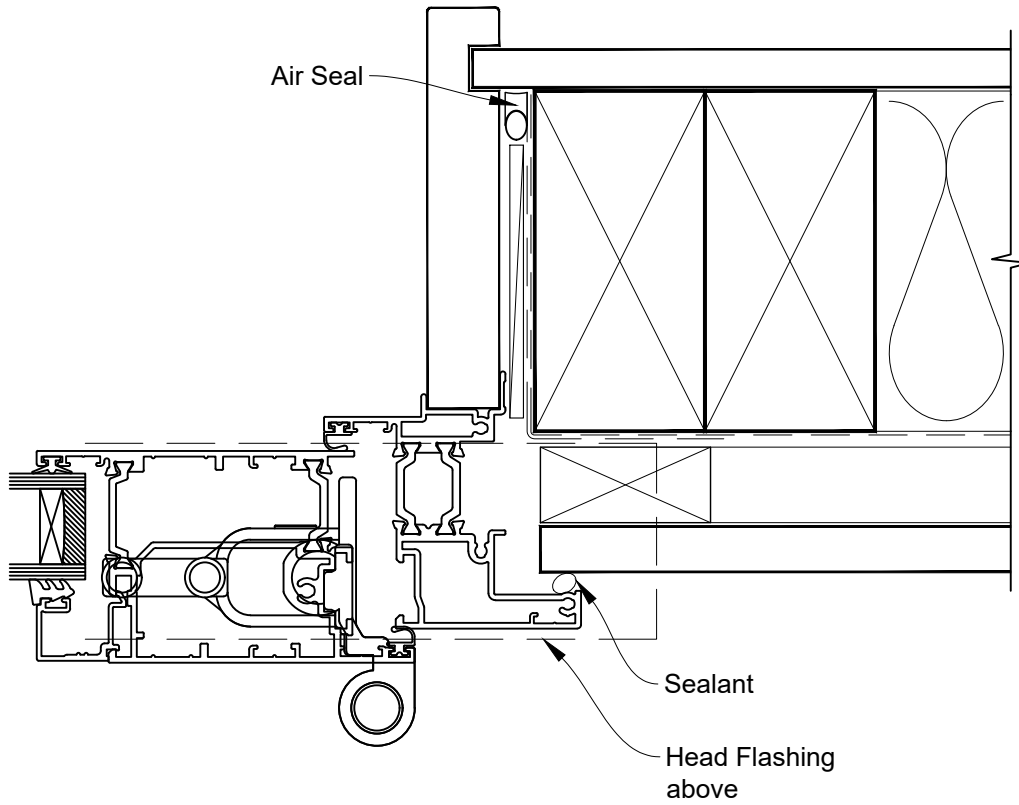



INSTALLATION DETAIL - RESIDENTIAL THERMAL HEART BIFOLD DOOR OPEN OUT ON FLAT SHEET CAVITY CONSTRUCTION

Date: 01.01.23

Scale: 1:2

CAD Ref.: TRBDFS-CS

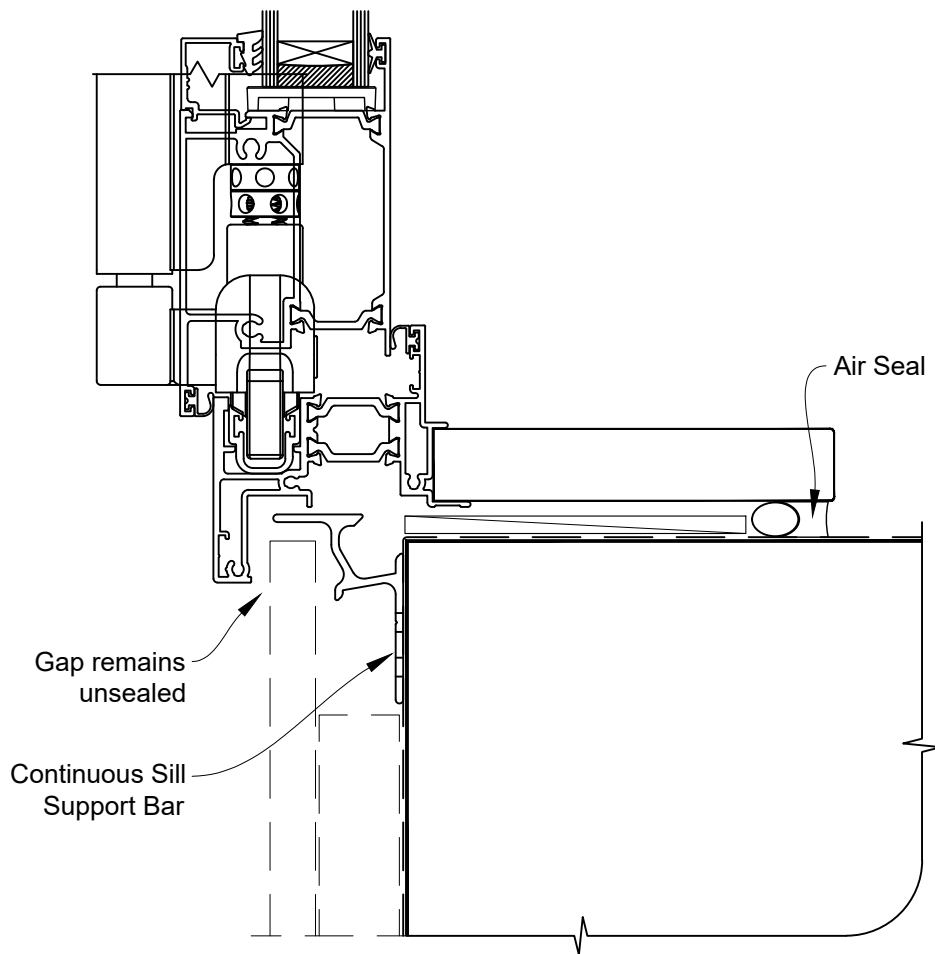



INSTALLATION DETAIL - RESIDENTIAL THERMAL HEART BIFOLD DOOR OPEN OUT ON FLAT SHEET DIRECT FIXED CLADDING

Date: 01.01.23

Scale: 1:2

CAD Ref.: TRBDFS-DH

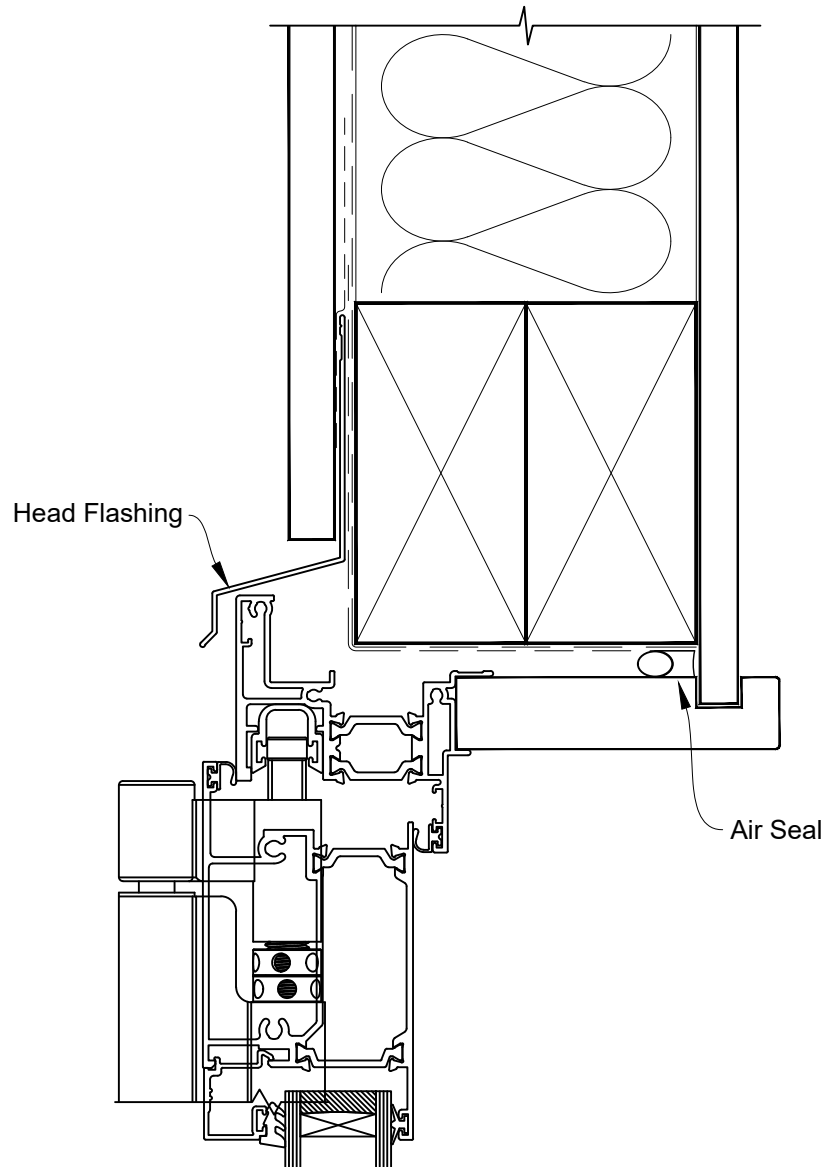



INSTALLATION DETAIL - RESIDENTIAL THERMAL HEART BIFOLD DOOR OPEN OUT ON FLAT SHEET DIRECT FIXED CLADDING

Date: 01.01.23

Scale: 1:2

CAD Ref.: TRBDFS-DJ

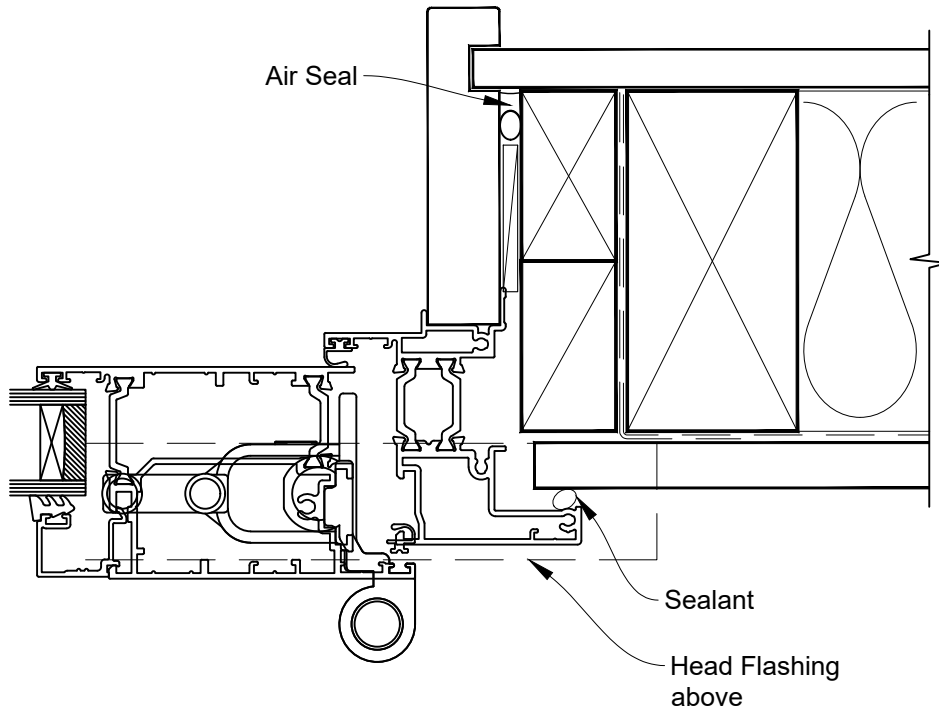



INSTALLATION DETAIL - RESIDENTIAL THERMAL HEART BIFOLD DOOR OPEN OUT ON FLAT SHEET DIRECT FIXED CLADDING

Date: 01.01.23

Scale: 1:2

CAD Ref.: TRBDFS-DS

