

HINGED DOOR, OPEN IN AND OUT WITH OVERLIGHT TRANSOM

CROSS SECTION

Cad Ref. AHD07-0 Scale 1:2 Date 01.04.19

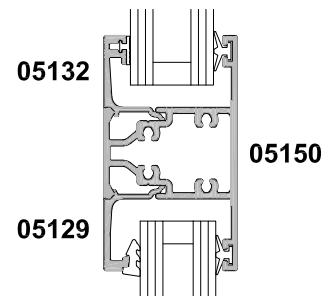
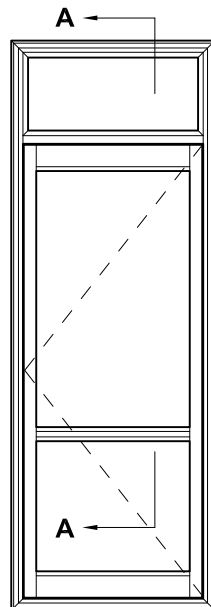
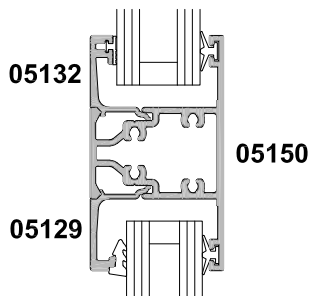
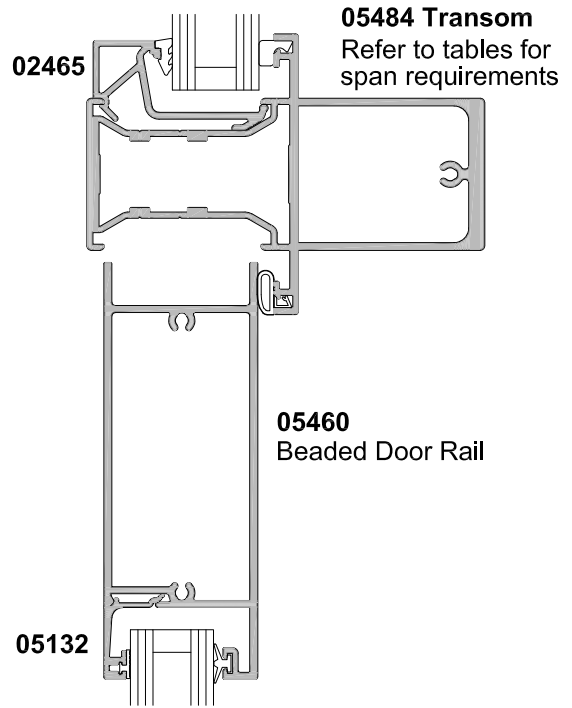
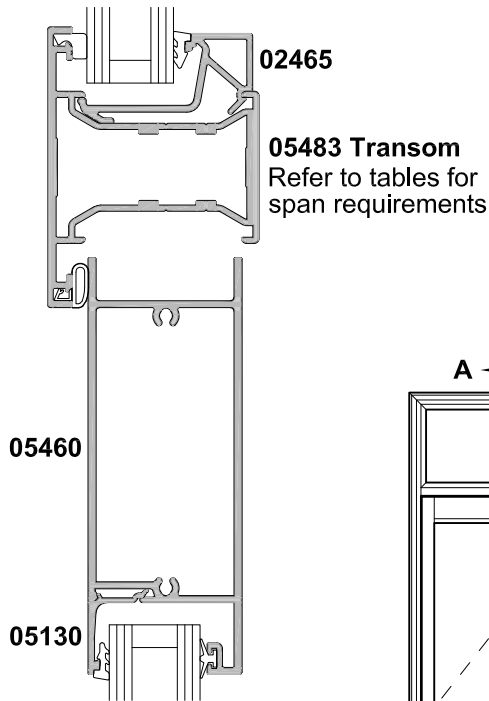
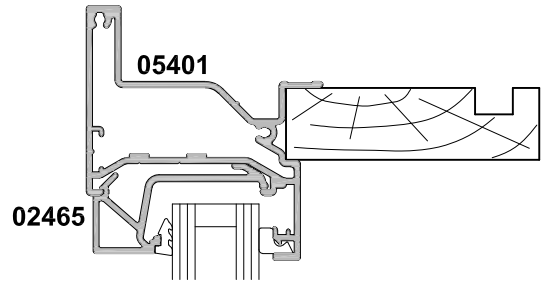
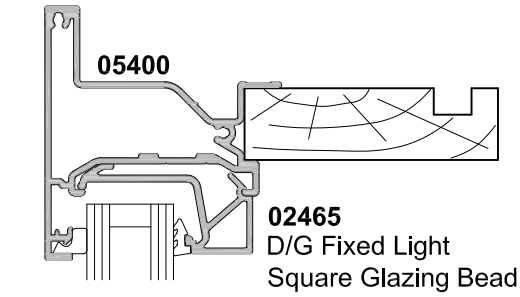

SECTION A-A
OPEN IN

SECTION A-A
OPEN OUT