



ENTRANCE HANDLES

———— V 2 ————



Entrance Handles Fixing Options

GD FIX - glass doors

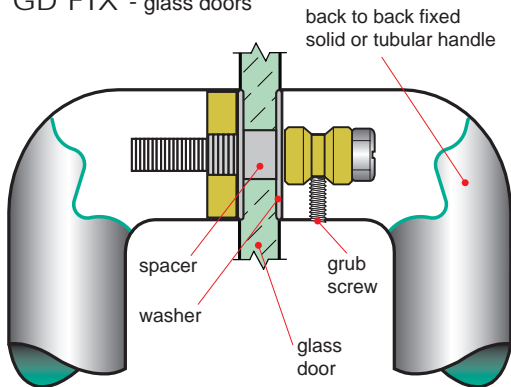

TM FIX - timber or metal doors

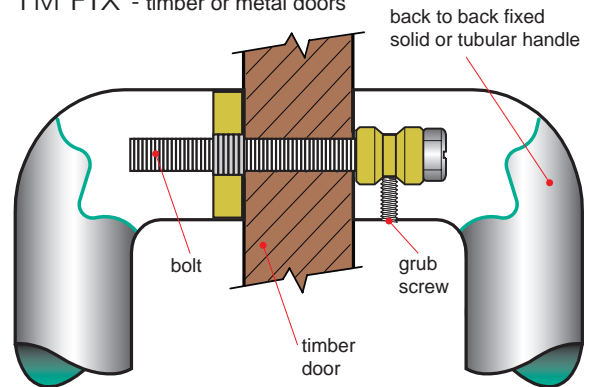

D FIX - glass, metal or timber doors

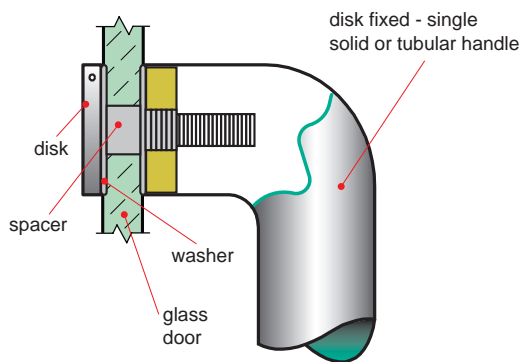

C FIX - timber doors only

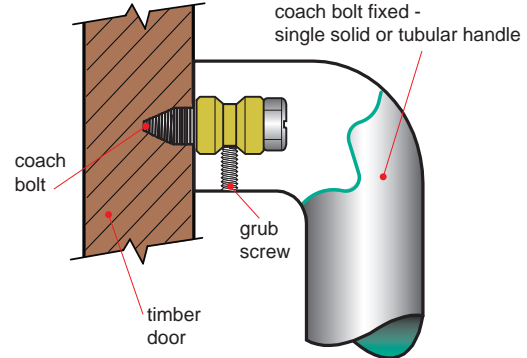

Nylon spacers and washers are included with handle for glass door fixing option

Drilling Details

Timber Door Fixings

Material Size	Bolt Size
32mm Ø	8mm
25mm Ø	8mm
19mm Ø	8mm
16mm Ø	5mm
14mm Ø	5mm

Metal Door Fixings

Material Size	Bolt Size
32mm Ø	8mm
25mm Ø	8mm
19mm Ø	8mm
16mm Ø	5mm
14mm Ø	5mm

Glass Door Fixings

Material Size	Hole Size
32mm Ø	12mm Ø
25mm Ø	12mm Ø
19mm Ø	12mm Ø
16mm Ø	12mm Ø
14mm Ø	12mm Ø

Handling Details

Door Opening In

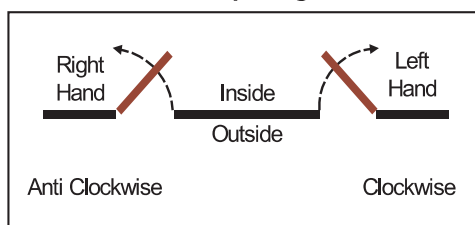

Door Opening Out

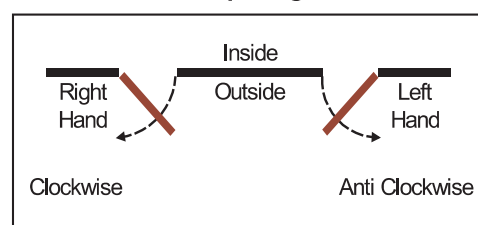

ENTRANCE HANDLES CATEGORY STYLES

Straight Round Stainless Steel	Page #	Offset Round Stainless Steel	Page #
MDZ B1000	8	MDZ 5250	15
MDZ 2019	9	MDZ 5450	17
MDZ 5200	14	MDZ 6250	19
MDZ 5400	16	MDZ 6450	22
MDZ 6200	18	MDZ 6500	23
MDZ 6300	20	MDZ 8090	34
MDZ 6400	21	MDZ 8120	37
MDZ 8040	29	MDZ 8160	42
MDZ 8070	32	MDZ 8190	45
MDZ 8100	35	MDZ 8220	48
MDZ 8130	38	MDZ 8260	52
MDZ 8210	47	MDZ 8390	61
MDZ 8240	50	MDZ 8400	62
MDZ 8270	53		
MDZ 8340	56		
MDZ 8580	94		
MDZ 8590	95		
Straight Square Stainless Steel	Page #	Offset Square Stainless Steel	Page #
MDZ 2512	10	MDZ 2512OF	11
MDZ 2525	12	MDZ 2525OF	13
MDZ 8000	24	MDZ 8020	27
MDZ 8005	25	MDZ 8050	30
MDZ 8010	26	MDZ 8080	33
MDZ 8030	28	MDZ 8110	36
MDZ 8060	31	MDZ 8140	39
MDZ 8150	40	MDZ 8155	41
MDZ 8170	43	MDZ 8200	46
MDZ 8180	44	MDZ 8350	57
MDZ 8230	49	MDZ 8360	58
MDZ 8250	51	MDZ 8370	59
MDZ 8280	54		
MDZ 8330	55		
MDZ 8380	60		
MDZ 8410	63		
MDZ 8420	64		
MDZ 8430	65		
Straight Timber	Page #	Offset Timber	Page #
MDZ 8440	66	MDZ 8480	74
MDZ 8445	67	MDZ 8485	75
MDZ 8450	68	MDZ 8500	78
MDZ 8455	69	MDZ 8505	79
MDZ 8460	70	MDZ 8520	82
MDZ 8465	71	MDZ 8525	83
MDZ 8470	72	MDZ 8570	92
MDZ 8475	73	MDZ 8575	93
MDZ 8490	76		
MDZ 8495	77		
MDZ 8510	80		
MDZ 8515	81		
MDZ 8530	84		
MDZ 8535	85		
MDZ 8540	86		
MDZ 8545	87		
MDZ 8550	88		
MDZ 8555	89		
MDZ 8560	90		
MDZ 8565	91		



NOTE:
AS1428 Compliant products
are indicated in **BOLD**

INTRODUCTION

Inspired by design, innovation and functionality, we are pleased to present our Entrance Handles catalogue.

Madinoz - as the name implies, is Made In OZ. It is our ability to work closely with architects, designers and developers which has allowed us to evolve with the market.

We are manufacturers of an ever expanding comprehensive range of architectural door hardware and use only quality materials such as solid brass and 316 marine-grade stainless steel to ensure lifelong usage.

Architects and designers may now be confident in selecting a quality well priced range with a distinctive design theme that will 'speak' throughout the whole project.

Madinoz combines handcrafted tradition with modern technology, to provide a well-priced product range which is refined to the smallest detail.

Please feel free to contact Madinoz should you have any special requirements or if you would like one of our Architectural Consultants to call on you.

We look forward to helping you and thank you for your interest and support.

Madinoz Pty Ltd

Unit 3 / 1-7 Ada Avenue, Brookvale NSW 2100 Australia

Telephone: **(02) 9939 2007**

Facsimile: (02) 9939 8432

E-mail: sales@madinoz.com.au

Website: www.madinoz.com.au

GENERAL INFORMATION

Finishes:

SSS - Satin Stainless Steel

PSS - Polished Stainless Steel

Guarantee:

Madinoz Pty Ltd unconditionally guarantee their products against defects in workmanship and materials, subject to fair wear and tear within the normal working life of the product. Madinoz Pty Ltd assumes no liability for:

1. Improper installation or failure to follow fitting instructions.
2. Failure to improper maintenance.
3. Indirect or inconsequential loss or damage.
4. Cost of removal and/or replacement.
5. Cost of freight and/or travelling.

Design Registration:

Some of the products depicted in this catalogue are the subject of design registration.

Cleaning:

Madinoz products should be cleaned at regular intervals with a soft 'grit-free' cloth, clean soapy water and wiped dry.

Warning:

Do not use a scouring pad of any type as this will cause excessive wear on the plated finish.

MADINOZ PRODUCT RECYCLING STEWARDSHIP POLICY

“With greater concerns about sustainability, designers are looking for low environmental impact solutions but do not want to compromise on aesthetics; Madinoz offers both.”

Guy Frangi, Manager
Madinoz Architectural Door Hardware
Australia

Madinoz Architectural Door Hardware, the highly regarded Australian manufacturer of stylish and premium quality door hardware, is very pleased to comply with **The Good Environmental Choice Australia Label (GECA)** which indicates the environmental performance of a product from multi-criteria and a whole of the product life perspective. Products certified by GECA provide Green Star accredited professionals with the right resources for their Green Star projects.



To move towards sustainable consumption buyers need to recognise which products and services have preferable environmental outcomes.

Madinoz is committed to undertaking a **Product Recycling Stewardship Program**, under which all brass and stainless steel components manufactured by Madinoz can be returned through the selected distributor for recycling at the end of product life. Madinoz ensures that all brass or stainless steel hardware, fittings, handles and accessories returned at product end of life will be recycled through relevant resource recovery networks and will not end up in Landfill*.

No other costs are chargeable to the consumer apart from transport cost to the Madinoz facility at Unit 3/1-7 Ada Avenue, Brookvale NSW 2100.

Please contact your distributor of Madinoz products to arrange return of goods. A tax receipt or some other documentary evidence from the original purchase must be retained in order to facilitate resource recovery.

WHY IS RECYCLING AND REDUCING THE IMPACT OF LANDFILL WASTE ON OUR ENVIRONMENT IMPORTANT?

The impacts of Landfill waste are a contributor to climate change.

The International Panel for Climate Change (IPCC) Fourth Assessment Report (2007) established that is highly confident that anthropogenic impacts such as the burning of fossil fuels and a 'disposable lifestyle culture' are the reasons for climate change.

Australia disposes of 32 million tonnes of solid waste into Landfill every year. 40% of this is attributable to the Construction and Demolition sector (Australian Bureau of Statistics, 2002-03).

Results from a Department of Environmental and Climate Change (DECC) study in 2004-05 showed that there are opportunities for up to 40% of the Construction & Demolition waste disposed to Landfill in the Sydney Metropolitan Area. The study estimated 30,000 tonnes of this was ferrous metals.

In recognising the critical role that the building industry plays in climate change in creating it and solving it, attaining the Good Environmental Choice Australia label and providing a Product Recycling Stewardship Policy is our way of moving towards sustainable consumption and being part of the solution.

For further information please contact Madinoz.

Unit 3 / 1-7 Ada Avenue, Brookvale NSW 2100 Australia

Telephone: **(02) 9939 2007**

Facsimile: (02) 9939 8432

E-mail: sales@madinoz.com.au

Website: www.madinoz.com.au

Entry Door Pull Handle - Lockable

Material 316 Marine Grade Stainless Steel

Product No.	Diameter mm	Length mm	Fixing Centres mm
Single Cylinder			
MDZ B1000	35	1500	1125

NOTE:
 External cylinder
 Internal turn
 Cylinder is 6 pin master keyable



HOW TO SPECIFY

Product No. / Diameter / Length / Finish / Door Type (refer diagram below)

eg: B1000 / 35 / 1500 / SSS / GD

B = BACK TO BACK FIX

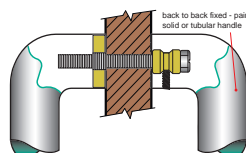

PLEASE SPECIFY DOOR TYPE

GD - Glass doors

TM - Timber doors

AL - Aluminium doors

Entry Door Pull Handle

Material 316 Marine Grade Stainless Steel



Product No.	Diameter mm	Projection mm	Length mm
MDZ 2019/K	19	69	1400
MDZ 2019/L	19	69	1300
MDZ 2019/M	19	69	1200
MDZ 2019/N	19	69	1100
MDZ 2019/O	19	69	1000
MDZ 2019/P	19	69	900
MDZ 2019/Q	19	69	800
MDZ 2019/R	19	69	700
MDZ 2019/S	19	69	600
MDZ 2019/T	19	69	500
MDZ 2019/U	19	69	400

HOW TO SPECIFY

Product No. / Diameter / Projector / Finish / Fixing (refer diagram below)

eg: 2019K / 19 / 69 / SSS / D Fix GD

B = BACK TO BACK FIX

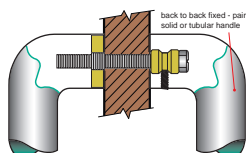

D = DISK FIX

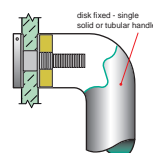

C = CONCEALED FIX

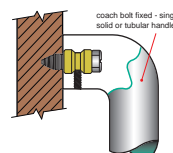

PLEASE SPECIFY DOOR TYPE

GD - Glass doors

TM - Timber doors

AL - Aluminium doors

Entry Door Pull Handle

Material 316 Marine Grade Stainless Steel



Product No.	Fixing Centres mm	Rail Section mm	Standoff mm	Unit	Projection mm	Overall Length mm
-------------	-------------------	-----------------	-------------	------	---------------	-------------------

Back to Back Fix

MDZ B2512	600	12x25	25x12	Pair	50	612
MDZ B2512	450	12x25	25x12	Pair	50	462
MDZ B2512	300	12x25	25x12	Pair	50	312
MDZ B2512	200	12x25	25x12	Pair	50	212

Disk Fix

MDZ D2512	600	12x25	25x12	Single	50	612
MDZ D2512	450	12x25	25x12	Single	50	462
MDZ D2512	300	12x25	25x12	Single	50	312
MDZ D2512	200	12x25	25x12	Single	50	212

Concealed Fix

MDZ C2512	600	12x25	25x12	Single	50	612
MDZ C2512	450	12x25	25x12	Single	50	462
MDZ C2512	300	12x25	25x12	Single	50	312
MDZ C2512	200	12x25	25x12	Single	50	212

NOTE:
Special sizes available on request



HOW TO SPECIFY

Product No. / Fixing Centres / Rail Section / Finish / Fixing (refer diagram below)

eg: B2512 / 600 / 12x25 / SSS / TM

B = BACK TO BACK FIX

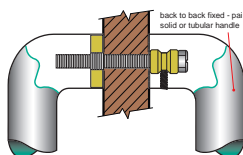

D = DISK FIX

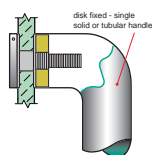

C = CONCEALED FIX

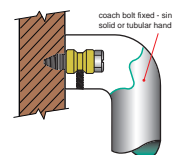

PLEASE SPECIFY DOOR TYPE
GD - Glass doors
TM - Timber doors
AL - Aluminium doors

Entry Door Pull Handle

Material 316 Marine Grade Stainless Steel

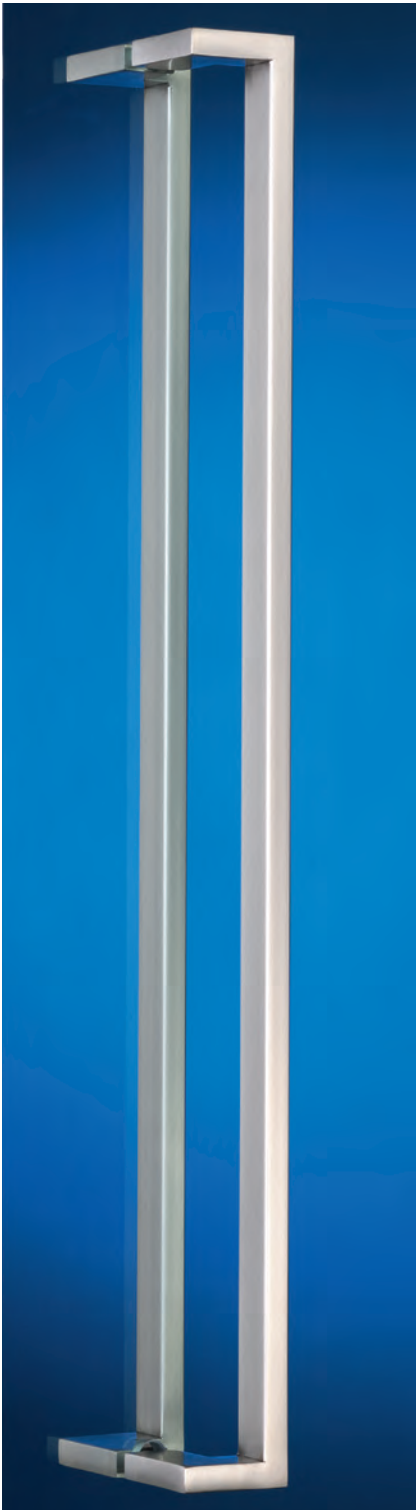

Product No.	Fixing Centres mm	Rail Section mm	Standoff mm	Unit	Projection mm	Offset mm
-------------	-------------------	-----------------	-------------	------	---------------	-----------

Back to Back Fix

MDZ B2512OF	600	12x25	25x12	Pair	60	50
MDZ B2512OF	450	12x25	25x12	Pair	60	50
MDZ B2512OF	300	12x25	25x12	Pair	60	50
MDZ B2512OF	200	12x25	25x12	Pair	60	50

Disk Fix

MDZ D2512OF	600	12x25	25x12	Single	60	50
MDZ D2512OF	450	12x25	25x12	Single	60	50
MDZ D2512OF	300	12x25	25x12	Single	60	50
MDZ D2512OF	200	12x25	25x12	Single	60	50

Concealed Fix

MDZ C2512OF	600	12x25	25x12	Single	60	50
MDZ C2512OF	450	12x25	25x12	Single	60	50
MDZ C2512OF	300	12x25	25x12	Single	60	50
MDZ C2512OF	200	12x25	25x12	Single	60	50

NOTE:
Special sizes available on request



HOW TO SPECIFY

Product No. / Fixing Centres / Rail Section / Finish / Fixing (refer diagram below)

eg: B2512OF / 600 / 12x25 / SSS / TM

B = BACK TO BACK FIX

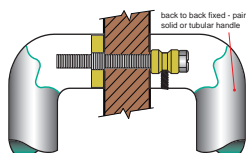

D = DISK FIX

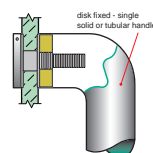

C = CONCEALED FIX

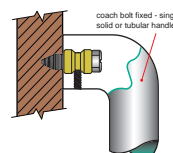

PLEASE SPECIFY DOOR TYPE

GD - Glass doors

TM - Timber doors

AL - Aluminium doors

Entry Door Pull Handle

Material 316 Marine Grade Stainless Steel

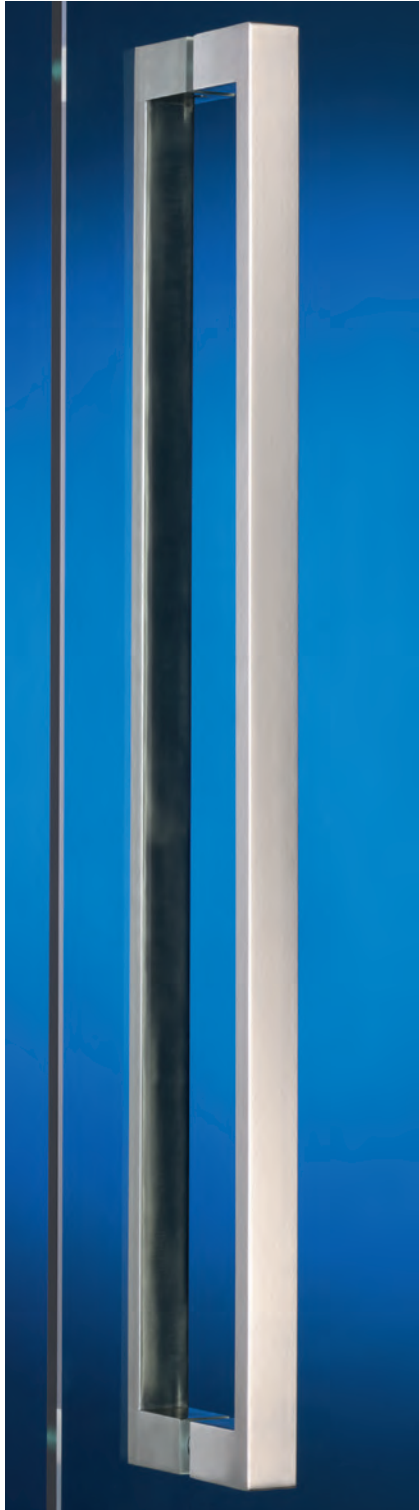

Product No.	Fixing Centres mm	Rail Section mm	Standoff mm	Unit	Projection mm	Overall Length mm
-------------	-------------------	-----------------	-------------	------	---------------	-------------------

Back to Back Fix

MDZ B2525	600	10x25	25x25	Pair	50	625
MDZ B2525	450	10x25	25x25	Pair	50	475
MDZ B2525	300	10x25	25x25	Pair	50	325
MDZ B2525	200	10x25	25x25	Pair	50	225

Disk Fix

MDZ D2525	600	10x25	25x25	Single	50	625
MDZ D2525	450	10x25	25x25	Single	50	475
MDZ D2525	300	10x25	25x25	Single	50	325
MDZ D2525	200	10x25	25x25	Single	50	225

Concealed Fix

MDZ C2525	600	10x25	25x25	Single	50	625
MDZ C2525	450	10x25	25x25	Single	50	475
MDZ C2525	300	10x25	25x25	Single	50	325
MDZ C2525	200	10x25	25x25	Single	50	225

NOTE:
Special sizes available on request



HOW TO SPECIFY

Product No. / Fixing Centres / Rail Section / Finish / Fixing (refer diagram below)

eg: B2525 / 600 / 10x25 / SSS / TM

B = BACK TO BACK FIX

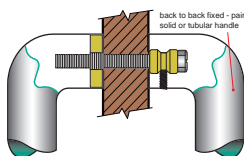

back to back fixed - pair solid or tubular handle

D = DISK FIX

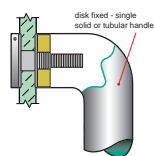

disk fixed - single solid or tubular handle

C = CONCEALED FIX

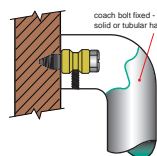

conceal bolt fixed - single solid or tubular handle

PLEASE SPECIFY DOOR TYPE

GD - Glass doors

TM - Timber doors

AL - Aluminium doors

Entry Door Pull Handle

Material 316 Marine Grade Stainless Steel

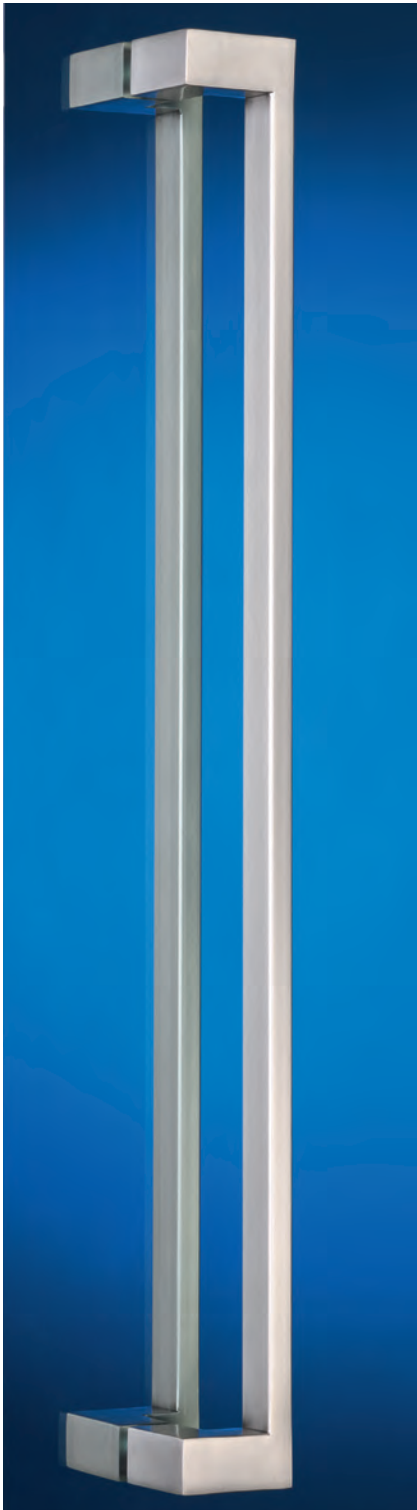

Product No.	Fixing Centres mm	Rail Section mm	Standoff mm	Unit	Projection mm	Offset mm
-------------	-------------------	-----------------	-------------	------	---------------	-----------

Back to Back Fix

MDZ B2525OF	600	25x12	25x25	Pair	60	50
MDZ B2525OF	450	25x12	25x25	Pair	60	50
MDZ B2525OF	300	25x12	25x25	Pair	60	50
MDZ B2525OF	200	25x12	25x25	Pair	60	50

Disk Fix

MDZ D2525OF	600	25x12	25x25	Single	60	50
MDZ D2525OF	450	25x12	25x25	Single	60	50
MDZ D2525OF	300	25x12	25x25	Single	60	50
MDZ D2525OF	200	25x12	25x25	Single	60	50

Concealed Fix

MDZ C2525OF	600	25x12	25x25	Single	60	50
MDZ C2525OF	450	25x12	25x25	Single	60	50
MDZ C2525OF	300	25x12	25x25	Single	60	50
MDZ C2525OF	200	25x12	25x25	Single	60	50

NOTE:
Special sizes available on request



HOW TO SPECIFY

Product No. / Fixing Centres / Rail Section / Finish / Fixing (refer diagram below)

eg: B2525OF / 600 / 25x12 / SSS / TM

B = BACK TO BACK FIX

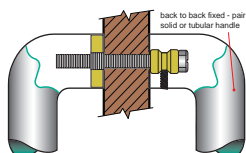

D = DISK FIX

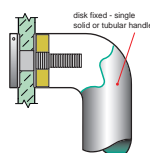

C = CONCEALED FIX

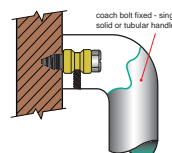

PLEASE SPECIFY DOOR TYPE

GD - Glass doors

TM - Timber doors

AL - Aluminium doors

Entry Door Pull Handle

Material 316 Marine Grade Stainless Steel



Product No.	Diameter mm		Length mm	Fixing Centres mm
MDZ 5200/K	16	14	1400	1240
MDZ 5200/L	16	14	1300	1140
MDZ 5200/M	16	14	1200	1040
MDZ 5200/N	16	14	1100	940
MDZ 5200/O	16	14	1000	840
MDZ 5200/P	16	14	900	740
MDZ 5200/Q	16	14	800	640
MDZ 5200/R	16	14	700	540
MDZ 5200/S	16	14	600	440
MDZ 5200/T	16	14	500	340
MDZ 5200/U	16	14	400	240

NOTE:
Special sizes available on request

HOW TO SPECIFY

Product No. / Diameter / Length / Finish / Fixing (refer diagram below)

eg: 5200K / 16 / 1400 / SSS / D Fix GD

B = BACK TO BACK FIX

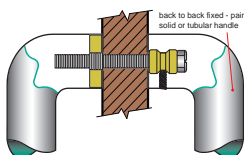

D = DISK FIX

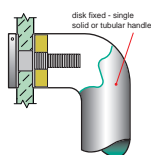

C = CONCEALED FIX

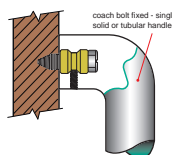

PLEASE SPECIFY DOOR TYPE

GD - Glass doors

TM - Timber doors

AL - Aluminium doors

Entry Door Pull Handle

Material 316 Marine Grade Stainless Steel

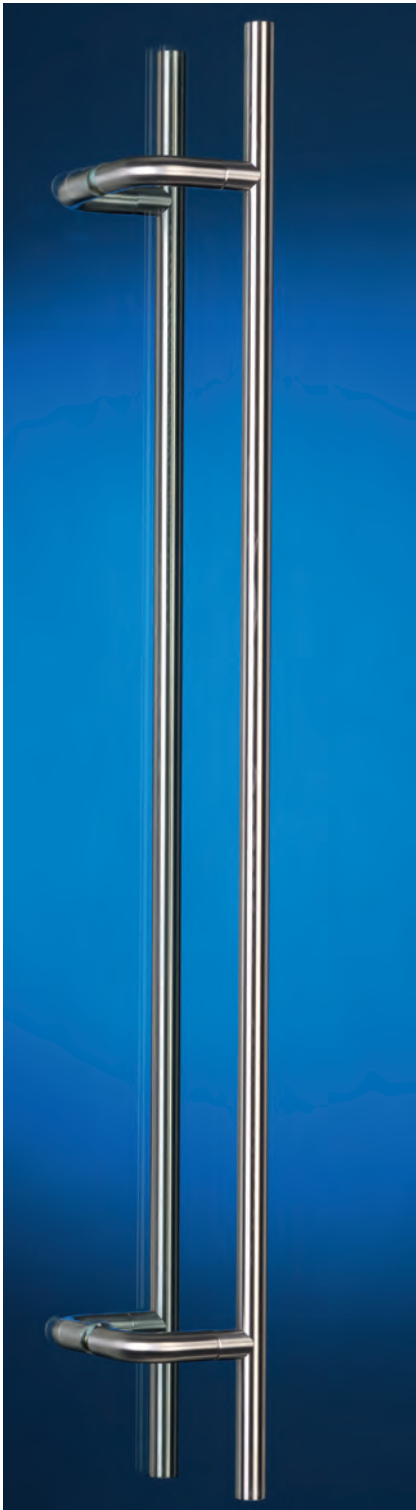

Product No.	Diameter mm		Projection mm		Offset mm		Length mm	Fixing Centres mm
MDZ 5250/K	16	14	50	48	85	80	1400	1240
MDZ 5250/L	16	14	50	48	85	80	1300	1140
MDZ 5250/M	16	14	50	48	85	80	1200	1040
MDZ 5250/N	16	14	50	48	85	80	1100	940
MDZ 5250/O	16	14	50	48	85	80	1000	840
MDZ 5250/P	16	14	50	48	85	80	900	740
MDZ 5250/Q	16	14	50	48	85	80	800	640
MDZ 5250/R	16	14	50	48	85	80	700	540
MDZ 5250/S	16	14	50	48	85	80	600	440
MDZ 5250/T	16	14	50	48	85	80	500	340
MDZ 5250/U	16	14	50	48	85	80	400	240

NOTE:
Special sizes available on request

HOW TO SPECIFY

Product No. / Diameter / Projection / Finish / Fixing (refer diagram below)

eg: 5250K / 16 / 50 / SSS / D Fix GD

B = BACK TO BACK FIX

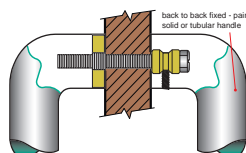

D = DISK FIX

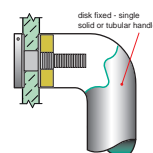

C = CONCEALED FIX

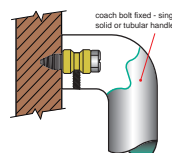

PLEASE SPECIFY DOOR TYPE
GD - Glass doors
TM - Timber doors
AL - Aluminium doors

Entry Door Pull Handle

Material 316 Marine Grade Stainless Steel



Product No.	Diameter mm		Length mm	Fixing Centres mm
MDZ 5400/K	16	14	1400	1240
MDZ 5400/L	16	14	1300	1140
MDZ 5400/M	16	14	1200	1040
MDZ 5400/N	16	14	1100	940
MDZ 5400/O	16	14	1000	840
MDZ 5400/P	16	14	900	740
MDZ 5400/Q	16	14	800	640
MDZ 5400/R	16	14	700	540
MDZ 5400/S	16	14	600	440
MDZ 5400/T	16	14	500	340
MDZ 5400/U	16	14	400	240

NOTE:
Special sizes available on request

HOW TO SPECIFY

Product No. / Diameter / Length / Finish / Fixing (refer diagram below)

eg: 5400K / 16 / 1400 / SSS / D Fix GD

B = BACK TO BACK FIX

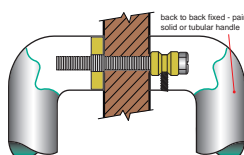

D = DISK FIX

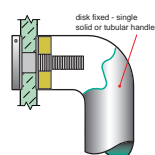

C = CONCEALED FIX

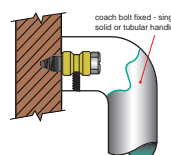

PLEASE SPECIFY DOOR TYPE

GD - Glass doors

TM - Timber doors

AL - Aluminium doors

Entry Door Pull Handle

Material 316 Marine Grade Stainless Steel



Product No.	Diameter mm		Projection mm		Offset mm		Length mm	Fixing Centres mm
MDZ 5450/K	16	14	50	48	80	75	1400	1240
MDZ 5450/L	16	14	50	48	80	75	1300	1140
MDZ 5450/M	16	14	50	48	80	75	1200	1040
MDZ 5450/N	16	14	50	48	80	75	1100	940
MDZ 5450/O	16	14	50	48	80 <td 75	1000	840	
MDZ 5450/P	16	14	50	48	80	75	900	740
MDZ 5450/Q	16	14	50	48	80	75	800	640
MDZ 5450/R	16	14	50	48	80	75	700	540
MDZ 5450/S	16	14	50	48	80	75	600	440
MDZ 5450/T	16	14	50	48	80	75	500	340
MDZ 5450/U	16	14	50	48	80	75	400	240

NOTE:
Special sizes available on request

HOW TO SPECIFY

Product No. / Diameter / Projection / Finish / Fixing (refer diagram below)

eg: 5450K / 16 / 50 / SSS / D Fix GD

B = BACK TO BACK FIX

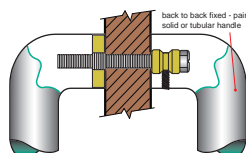

D = DISK FIX

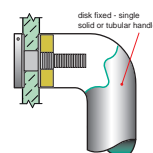

C = CONCEALED FIX

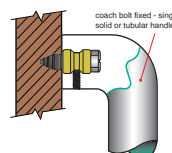

PLEASE SPECIFY DOOR TYPE

GD - Glass doors

TM - Timber doors

AL - Aluminium doors

Entry Door Pull Handle

Material 316 Marine Grade Stainless Steel



Product No.	Diameter mm			Length mm	Fixing Centres mm
MDZ 6200/A	32	25	19	2400	2240
MDZ 6200/B	32	25	19	2300	2140
MDZ 6200/C	32	25	19	2200	2040
MDZ 6200/D	32	25	19	2100	1940
MDZ 6200/E	32	25	19	2000	1840
MDZ 6200/F	32	25	19	1900	1740
MDZ 6200/G	32	25	19	1800	1640
MDZ 6200/H	32	25	19	1700	1540
MDZ 6200/I	32	25	19	1600	1440
MDZ 6200/J	32	25	19	1500	1340
MDZ 6200/K	32	25	19	1400	1240
MDZ 6200/L	32	25	19	1300	1140
MDZ 6200/M	32	25	19	1200	1040
MDZ 6200/N	32	25	19	1100	940
MDZ 6200/O	32	25	19	1000	840
MDZ 6200/P	32	25	19	900	740
MDZ 6200/Q	32	25	19	800	640
MDZ 6200/R	32	25	19	700	540
MDZ 6200/S	32	25	19	600	440
MDZ 6200/T	32	25	19	500	340
MDZ 6200/U	32	25	19	400	240

NOTE:
Special sizes available on request



HOW TO SPECIFY

Product No. / Diameter / Length / Finish / Fixing (refer diagram below)

eg: 6200A / 32 / 2400 / SSS / D Fix GD

B = BACK TO BACK FIX

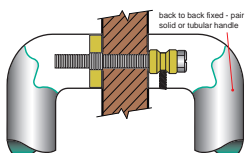

D = DISK FIX

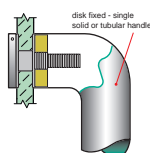

C = CONCEALED FIX

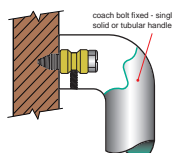

PLEASE SPECIFY DOOR TYPE

GD - Glass doors

TM - Timber doors

AL - Aluminium doors

Entry Door Pull Handle

Material 316 Marine Grade Stainless Steel



Product No.	Diameter mm	Projection mm	Offset mm	Length mm	Fixing Centres mm
MDZ 6250/G	19	65	90	1800	1640
MDZ 6250/H	19	65	90	1700	1540
MDZ 6250/I	19	65	90	1600	1440
MDZ 6250/J	19	65	90	1500	1340
MDZ 6250/K	19	65	90	1400	1240
MDZ 6250/L	19	65	90	1300	1140
MDZ 6250/M	19	65	90	1200	1040
MDZ 6250/N	19	65	90	1100	940
MDZ 6250/O	19	65	90	1000	840
MDZ 6250/P	19	65	90	900	740
MDZ 6250/Q	19	65	90	800	640
MDZ 6250/R	19	65	90	700	540
MDZ 6250/S	19	65	90	600	440
MDZ 6250/T	19	65	90	500	340
MDZ 6250/U	19	65	90	400	240

NOTE:
Special sizes available on request

HOW TO SPECIFY

Product No. / Diameter / Projection / Finish / Fixing (refer diagram below)

eg: 6250G / 19 / 65 / SSS / D Fix GD

B = BACK TO BACK FIX

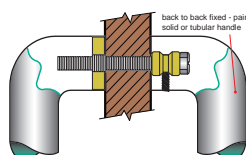

D = DISK FIX

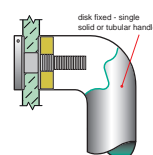

C = CONCEALED FIX

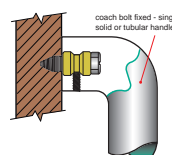

PLEASE SPECIFY DOOR TYPE

GD - Glass doors

TM - Timber doors

AL - Aluminium doors

Entry Door Pull Handle

Material 316 Marine Grade Stainless Steel

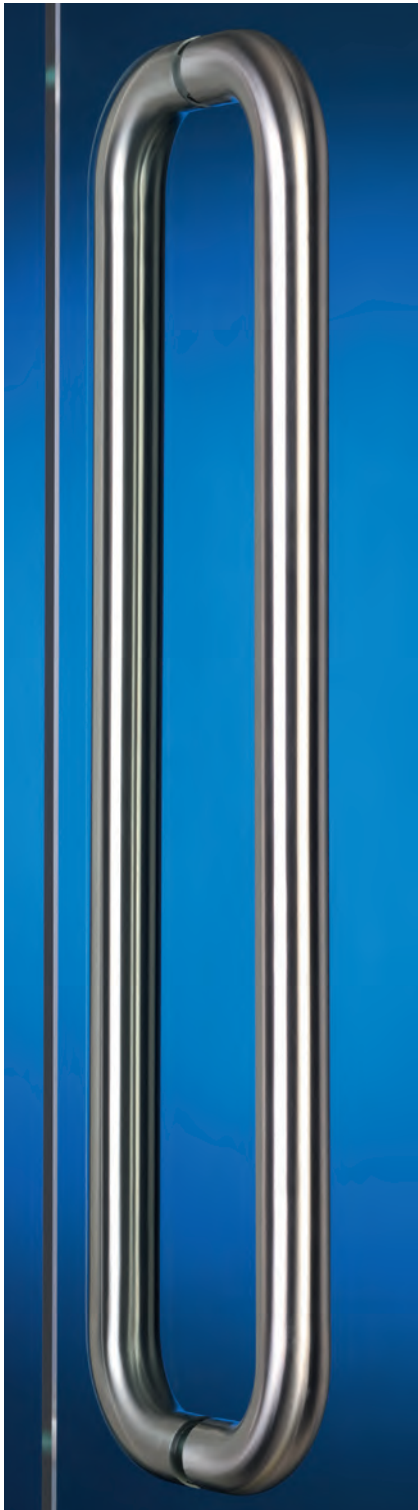

Product No.	Diameter mm		Projection mm		Fixing Centres mm
MDZ 6300/K	32	25	85	75	1400
MDZ 6300/L	32	25	85	75	1300
MDZ 6300/M	32	25	85	75	1200
MDZ 6300/N	32	25	85	75	1100
MDZ 6300/O	32	25	85	75	1000
MDZ 6300/P	32	25	85	75	900
MDZ 6300/Q	32	25	85	75	800
MDZ 6300/R	32	25	85	75	700
MDZ 6300/S	32	25	85	75	600
MDZ 6300/T	32	25	85	75	500
MDZ 6300/U	32	25	85	75	400
MDZ 6300/V	32	25	85	75	300
MDZ 6300/W	32	25	85	75	250
MDZ 6300/X	32	25	85	75	200

NOTE:
Special sizes available on request

HOW TO SPECIFY

Product No. / Diameter / Projection / Finish / Fixing (refer diagram below)

eg: 6300K / 32 / 85 / SSS / D Fix GD

B = BACK TO BACK FIX

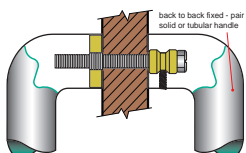

D = DISK FIX

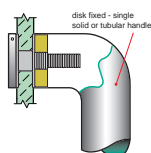

C = CONCEALED FIX

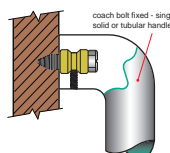

PLEASE SPECIFY DOOR TYPE
GD - Glass doors
TM - Timber doors
AL - Aluminium doors

Entry Door Pull Handle

Material 316 Marine Grade Stainless Steel



Product No.	Diameter mm			Projection mm			Length mm	Fixing Centres mm
MDZ 6400/A	32	25	19	77	70	64	2400	2240
MDZ 6400/B	32	25	19	77	70	64	2300	2140
MDZ 6400/C	32	25	19	77	70	64	2200	2040
MDZ 6400/D	32	25	19	77	70	64	2100	1940
MDZ 6400/E	32	25	19	77	70	64	2000	1840
MDZ 6400/F	32	25	19	77	70	64	1900	1740
MDZ 6400/G	32	25	19	77	70	64	1800	1640
MDZ 6400/H	32	25	19	77	70	64	1700	1540
MDZ 6400/I	32	25	19	77	70	64	1600	1440
MDZ 6400/J	32	25	19	77	70	64	1500	1340
MDZ 6400/K	32	25	19	77	70	64	1400	1240
MDZ 6400/L	32	25	19	77	70	64	1300	1140
MDZ 6400/M	32	25	19	77	70	64	1200	1040
MDZ 6400/N	32	25	19	77	70	64	1100	940
MDZ 6400/O	32	25	19	77	70	64	1000	840
MDZ 6400/P	32	25	19	77	70	64	900	740
MDZ 6400/Q	32	25	19	77	70	64	800	640
MDZ 6400/R	32	25	19	77	70	64	700	540
MDZ 6400/S	32	25	19	77	70	64	600	440
MDZ 6400/T	32	25	19	77	70	64	500	340
MDZ 6400/U	32	25	19	77	70	64	400	240

NOTE:
Special sizes available on request

HOW TO SPECIFY

Product No. / Diameter / Projection / Finish / Fixing (refer diagram below)

eg: 6400A / 32 / 77 / SSS / D Fix GD

B = BACK TO BACK FIX

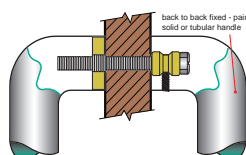

D = DISK FIX

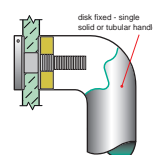

C = CONCEALED FIX

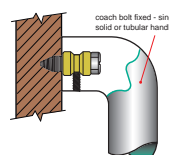

PLEASE SPECIFY DOOR TYPE

GD - Glass doors

TM - Timber doors

AL - Aluminium doors

Entry Door Pull Handle

Material 316 Marine Grade Stainless Steel



Product No.	Diameter mm	Projection mm	Offset mm	Length mm	Fixing Centres mm
MDZ 6450/G	19	65	95	1800	1640
MDZ 6450/H	19	65	95	1700	1540
MDZ 6450/I	19	65	95	1600	1440
MDZ 6450/J	19	65	95	1500	1340
MDZ 6450/K	19	65	95	1400	1240
MDZ 6450/L	19	65	95	1300	1140
MDZ 6450/M	19	65	95	1200	1040
MDZ 6450/N	19	65	95	1100	940
MDZ 6450/O	19	65	95	1000	840
MDZ 6450/P	19	65	95	900	740
MDZ 6450/Q	19	65	95	800	640
MDZ 6450/R	19	65	95	700	540
MDZ 6450/S	19	65	95	600	440
MDZ 6450/T	19	65	95	500	340
MDZ 6450/U	19	65	95	400	240

NOTE:
Special sizes available on request

HOW TO SPECIFY

Product No. / Diameter / Projection / Finish / Fixing (refer diagram below)

eg: 6450G / 19 / 65 / SSS / D Fix GD

B = BACK TO BACK FIX

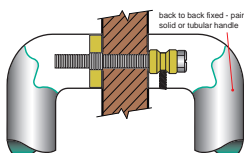

D = DISK FIX

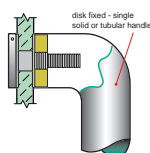

C = CONCEALED FIX

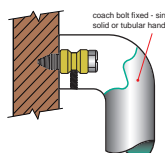

PLEASE SPECIFY DOOR TYPE

GD - Glass doors

TM - Timber doors

AL - Aluminium doors

Entry Door Pull Handle

Material 316 Marine Grade Stainless Steel



Product No.	Diameter mm		Projection mm		Offset mm		Length mm	Fixing Centres mm
MDZ 6500/A	32	25	83	70	90	85	2400	2240
MDZ 6500/B	32	25	83	70	90	85	2300	2140
MDZ 6500/C	32	25	83	70	90	85	2200	2040
MDZ 6500/D	32	25	83	70	90	85	2100	1940
MDZ 6500/E	32	25	83	70	90	85	2000	1840
MDZ 6500/F	32	25	83	70	90	85	1900	1740
MDZ 6500/G	32	25	83	70	90	85	1800	1640
MDZ 6500/H	32	25	83	70	90	85	1700	1540
MDZ 6500/I	32	25	83	70	90	85	1600	1440
MDZ 6500/J	32	25	83	70	90	85	1500	1340
MDZ 6500/K	32	25	83	70	90	85	1400	1240
MDZ 6500/L	32	25	83	70	90	85	1300	1140
MDZ 6500/M	32	25	83	70	90	85	1200	1040
MDZ 6500/N	32	25	83	70	90	85	1100	940
MDZ 6500/O	32	25	83	70	90	85	1000	840
MDZ 6500/P	32	25	83	70	90	85	900	740
MDZ 6500/Q	32	25	83	70	90	85	800	640
MDZ 6500/R	32	25	83	70	90	85	700	540
MDZ 6500/S	32	25	83	70	90	85	600	440
MDZ 6500/T	32	25	83	70	90	85	500	340
MDZ 6500/U	32	25	83	70	90	85	400	240

NOTE:

MDZ 6500/A to F to come with 3 stand offs (fixing points) in 25mm diameter only
Special sizes available on request



HOW TO SPECIFY

Product No. / Diameter / Projection / Finish / Fixing (refer diagram below)

eg: 6500A / 25 / 70 / SSS / D Fix GD

B = BACK TO BACK FIX

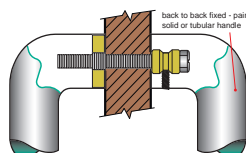

D = DISK FIX

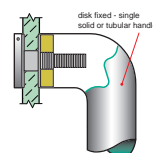

C = CONCEALED FIX

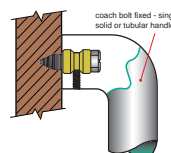

PLEASE SPECIFY DOOR TYPE

GD - Glass doors

TM - Timber doors

AL - Aluminium doors

Entry Door Pull Handle

Material 316 Marine Grade Stainless Steel

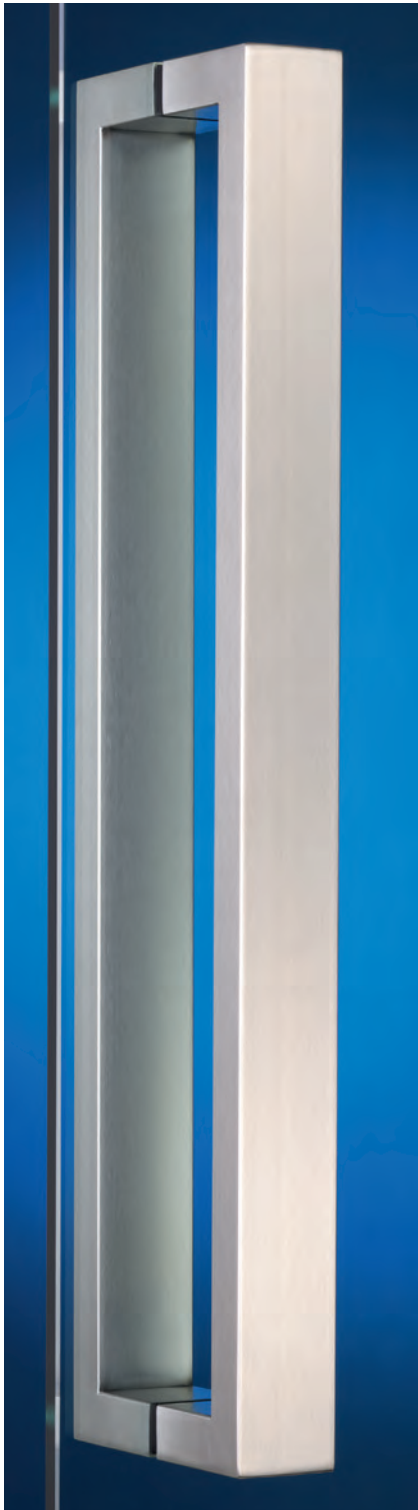

Product No.	Fixing Centres mm	Rail Section mm	Unit	Projection mm	Overall Length mm
-------------	-------------------	-----------------	------	---------------	-------------------

Back to Back Fix

MDZ B8000	1500	50x25	Pair	75	1525
MDZ B8000	1000	50x25	Pair	75	1025
MDZ B8000	800	50x25	Pair	75	825
MDZ B8000	600	50x25	Pair	75	625
MDZ B8000	400	50x25	Pair	75	425

Disk Fix

MDZ D8000	1500	50x25	Single	75	1525
MDZ D8000	1000	50x25	Single	75	1025
MDZ D8000	800	50x25	Single	75	825
MDZ D8000	600	50x25	Single	75	625
MDZ D8000	400	50x25	Single	75	425

Concealed Fix

MDZ C8000	1500	50x25	Single	75	1525
MDZ C8000	1000	50x25	Single	75	1025
MDZ C8000	800	50x25	Single	75	825
MDZ C8000	600	50x25	Single	75	625
MDZ C8000	400	50x25	Single	75	425

NOTE:

MDZ 8000 Series come in fixing centres from 400mm to 2000mm, in 100mm increments. Available in all fixes. Special sizes available on request



HOW TO SPECIFY

Product No. / Fixing Centres / Rail Section / Finish / Fixing (refer diagram below)

eg: B8000 / 800 / 50x25 / SSS / TM

B = BACK TO BACK FIX

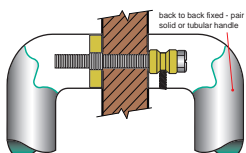

D = DISK FIX

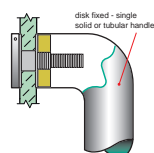

C = CONCEALED FIX

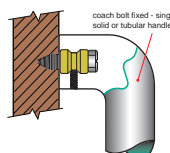

PLEASE SPECIFY DOOR TYPE

GD - Glass doors

TM - Timber doors

AL - Aluminium doors

Entry Door Pull Handle

Material 316 Marine Grade Stainless Steel

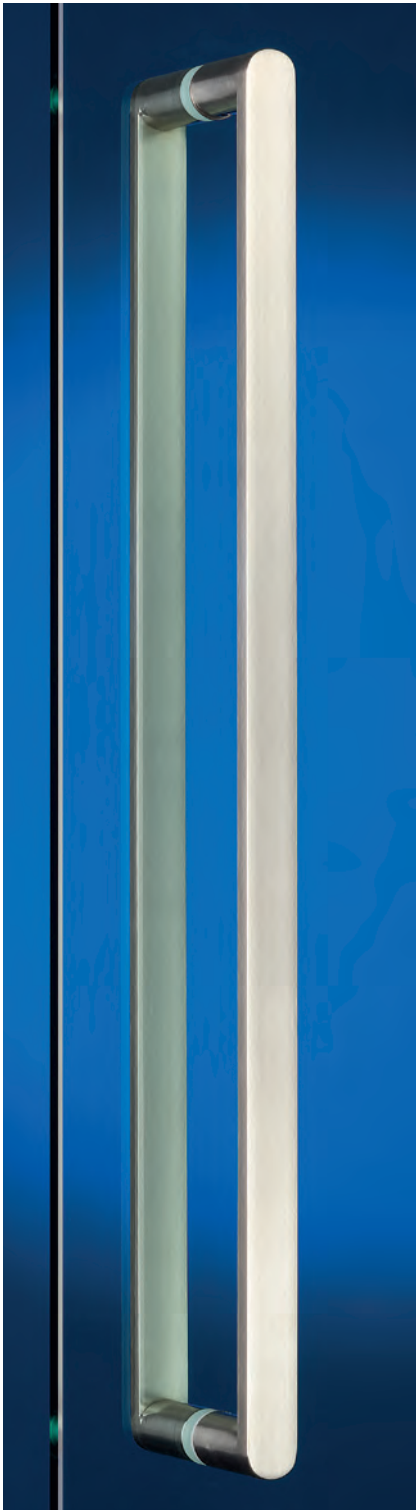

Product No.	Fixing Centres mm	Rail Section mm	Unit	Projection mm	Overall Length mm
-------------	-------------------	-----------------	------	---------------	-------------------

Back to Back Fix

MDZ B8005	900	25x10	Pair	55	925
MDZ B8005	600	25x10	Pair	55	625
MDZ B8005	450	25x10	Pair	55	475
MDZ B8005	300	25x10	Pair	55	325

Disk Fix

MDZ D8005	900	25x10	Single	55	925
MDZ D8005	600	25x10	Single	55	625
MDZ D8005	450	25x10	Single	55	475
MDZ D8005	300	25x10	Single	55	325

Concealed Fix

MDZ C8005	900	25x10	Single	55	925
MDZ C8005	600	25x10	Single	55	625
MDZ C8005	450	25x10	Single	55	475
MDZ C8005	300	25x10	Single	55	325

NOTE:
Special sizes available on request



HOW TO SPECIFY

Product No. / Fixing Centres / Rail Section / Finish / Fixing (refer diagram below)
eg: B8005 / 900 / 25x10 / SSS / TM

B = BACK TO BACK FIX

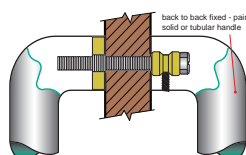

D = DISK FIX

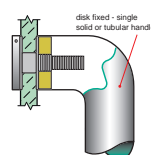

C = CONCEALED FIX

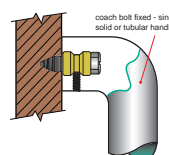

PLEASE SPECIFY DOOR TYPE
GD - Glass doors
TM - Timber doors
AL - Aluminium doors

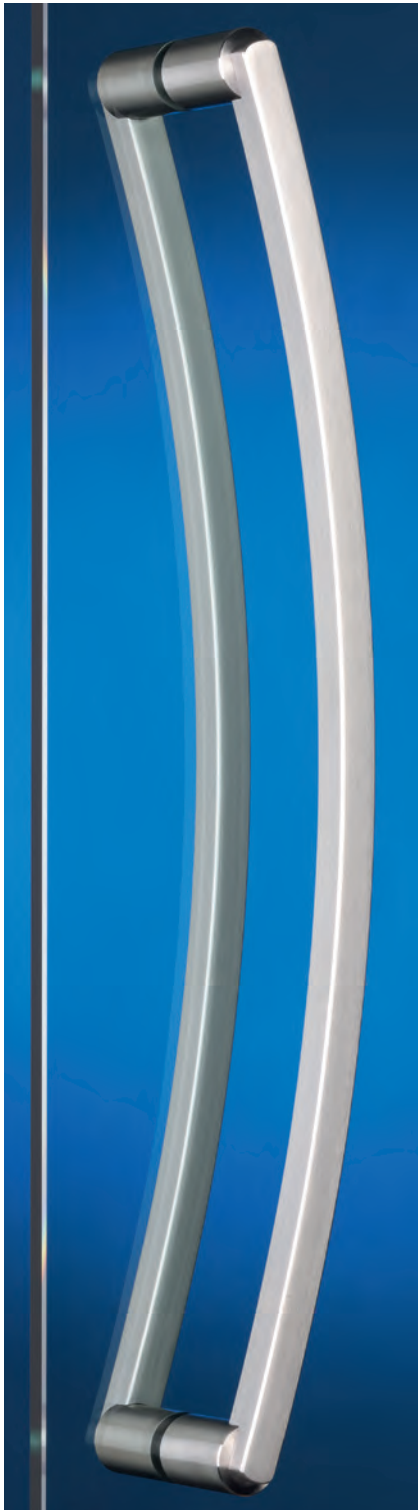

Product No.	Fixing Centres mm	Square Tube mm	Unit	Projection mm	Width mm	Overall Length mm
Back to Back Fix						
MDZ B8010	600	19	Pair	55	80	632
Disk Fix						
MDZ D8010	600	19	Single	55	80	632
Concealed Fix						
MDZ C8010	600	19	Single	55	80	632



HOW TO SPECIFY

Product No. / Fixing Centres / Square Tube / Finish / Fixing (refer diagram below)

eg: B8010 / 600 / 19 / SSS / TM

B = BACK TO BACK FIX

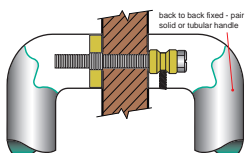

D = DISK FIX

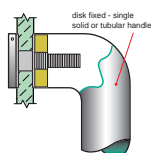

C = CONCEALED FIX

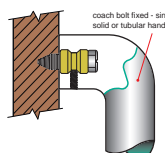

PLEASE SPECIFY DOOR TYPE

GD - Glass doors

TM - Timber doors

AL - Aluminium doors

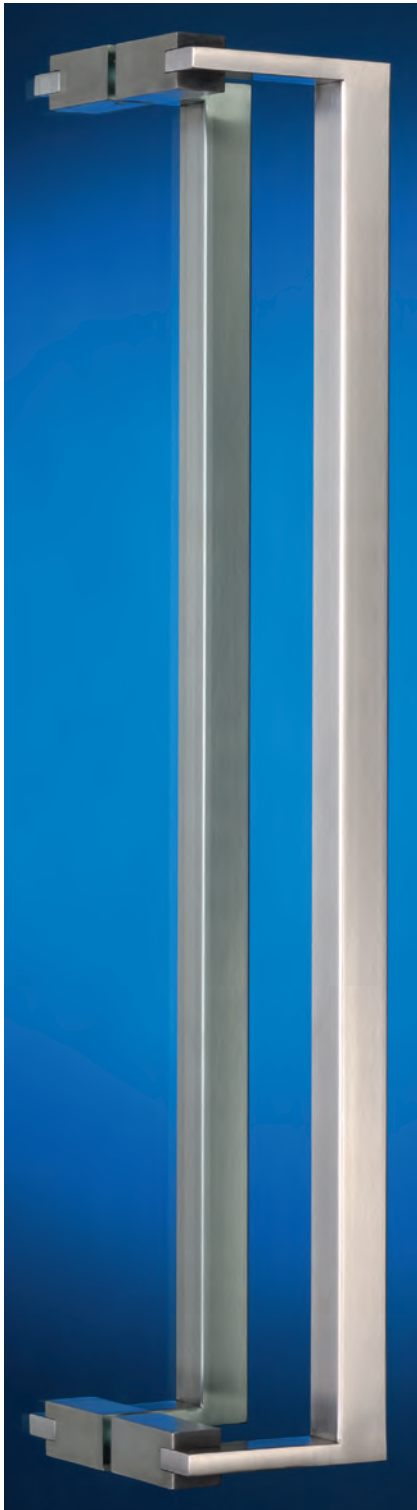

Product No.	Fixing Centres mm	Square Tube mm	Unit	Projection mm	Width mm	Overall Length mm
-------------	-------------------	----------------	------	---------------	----------	-------------------

Back to Back Fix

MDZ B8020	1500	25	Pair	70	100	1525
MDZ B8020	1000	25	Pair	70	100	1025
MDZ B8020	800	25	Pair	70	100	825
MDZ B8020	600	25	Pair	70	100	625
MDZ B8020	400	25	Pair	70	100	425

Disk Fix

MDZ D8020	1500	25	Single	70	100	1525
MDZ D8020	1000	25	Single	70	100	1025
MDZ D8020	800	25	Single	70	100	825
MDZ D8020	600	25	Single	70	100	625
MDZ D8020	400	25	Single	70	100	425

Concealed Fix

MDZ C8020	1500	25	Single	70	100	1525
MDZ C8020	1000	25	Single	70	100	1025
MDZ C8020	800	25	Single	70	100	825
MDZ C8020	600	25	Single	70	100	625
MDZ C8020	400	25	Single	70	100	425

NOTE:
Special sizes available on request



HOW TO SPECIFY

Product No. / Fixing Centres / Square Tube / Finish / Fixing (refer diagram below)

eg: B8020 / 1000 / 25 / SSS / TM

B = BACK TO BACK FIX

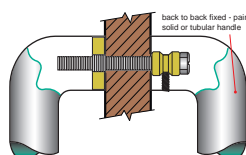

D = DISK FIX

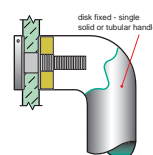

C = CONCEALED FIX

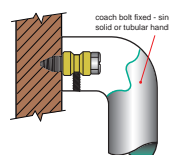

PLEASE SPECIFY DOOR TYPE

GD - Glass doors

TM - Timber doors

AL - Aluminium doors

Entry Door Pull Handle

Material 316 Marine Grade Stainless Steel

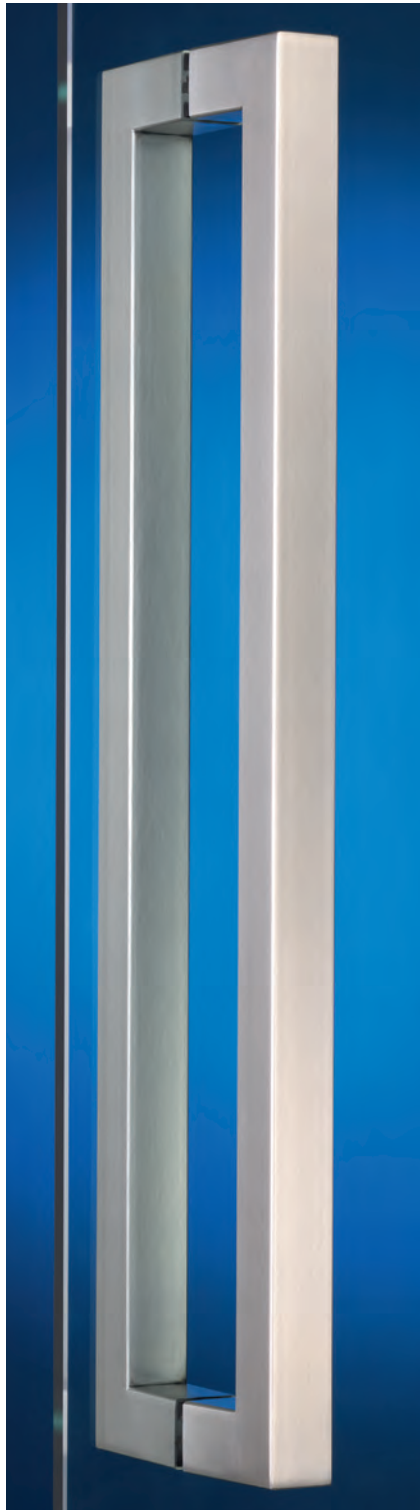

Product No.	Fixing Centres mm	Square Tube mm			Unit	Projection mm			Overall Length mm		
-------------	-------------------	----------------	--	--	------	---------------	--	--	-------------------	--	--

Back to Back Fix

MDZ B8030	1500	32	25	19	Pair	77	70	65	1532	1525	1519
MDZ B8030	1000	32	25	19	Pair	77	70	65	1032	1025	1019
MDZ B8030	800	32	25	19	Pair	77	70	65	832	825	819
MDZ B8030	600	32	25	19	Pair	77	70	65	632	625	619
MDZ B8030	400	32	25	19	Pair	77	70	65	432	425	419

Disk Fix

MDZ D8030	1500	32	25	19	Single	77	70	65	1532	1525	1519
MDZ D8030	1000	32	25	19	Single	77	70	65	1032	1025	1019
MDZ D8030	800	32	25	19	Single	77	70	65	832	825	819
MDZ D8030	600	32	25	19	Single	77	70	65	632	625	619
MDZ D8030	400	32	25	19	Single	77	70	65	432	425	419

Concealed Fix

MDZ C8030	1500	32	25	19	Single	77	70	65	1532	1525	1519
MDZ C8030	1000	32	25	19	Single	77	70	65	1032	1025	1019
MDZ C8030	800	32	25	19	Single	77	70	65	832	825	819
MDZ C8030	600	32	25	19	Single	77	70	65	632	625	619
MDZ C8030	400	32	25	19	Single	77	70	65	432	425	419

NOTE:

Also available in all fixes

MDZ 8030 Series in 32mm diameter come in fixing centres from 400mm to 2400mm, in 100mm increments.

MDZ 8030 Series in 25mm diameter come in fixing centres from 400mm to 2000mm, in 100mm increments.

MDZ 8030 Series in 19mm diameter come in fixing centres from 400mm to 1500mm, in 100mm increments.



HOW TO SPECIFY

Product No. / Fixing Centres / Square Tube / Finish / Fixing (refer diagram below)

eg: B8030 / 800 / 25 / SSS / TM

B = BACK TO BACK FIX

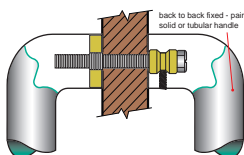

D = DISK FIX

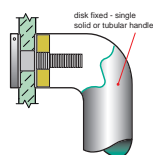

C = CONCEALED FIX

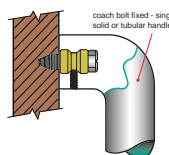

PLEASE SPECIFY DOOR TYPE

GD - Glass doors

TM - Timber doors

AL - Aluminium doors



Product No.	Fixing Centres mm	Flat Plate mm	Unit	Projection mm	Width mm	Overall Length mm
Back to Back Fix						
MDZ B8040	150	6	Pair	51	150	250
Disk Fix						
MDZ D8040	150	6	Single	51	150	250
Concealed Fix						
MDZ C8040	150	6	Single	51	150	250

Entry Door Pull Handle

Material 316 Marine Grade Stainless Steel

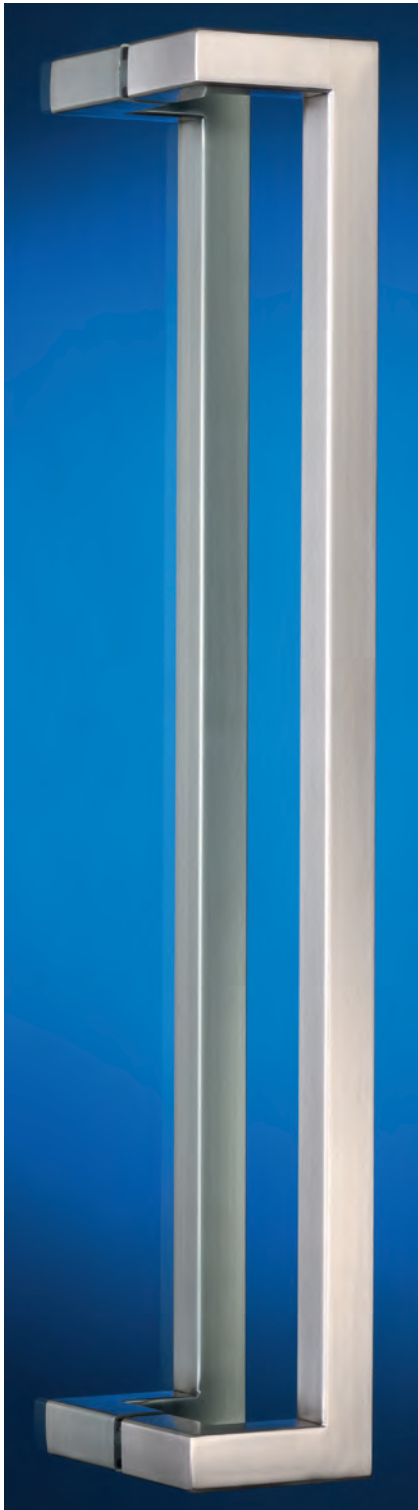

Product No.	Fixing Centres mm	Square Tube mm			Unit	Projection mm			Width mm			Overall Length mm		
-------------	-------------------	----------------	--	--	------	---------------	--	--	----------	--	--	-------------------	--	--

Back to Back Fix

MDZ B8050	1500	32	25	19	Pair	72	65	60	90	90	90	1532	1525	1519
MDZ B8050	1000	32	25	19	Pair	72	65	60	90	90	90	1032	1025	1019
MDZ B8050	800	32	25	19	Pair	72	65	60	90	90	90	832	825	819
MDZ B8050	600	32	25	19	Pair	72	65	60	90	90	90	632	625	619
MDZ B8050	400	32	25	19	Pair	72	65	60	90	90	90	432	425	419

Disk Fix

MDZ D8050	1500	32	25	19	Single	72	65	60	90	90	90	1532	1525	1519
MDZ D8050	1000	32	25	19	Single	72	65	60	90	90	90	1032	1025	1019
MDZ D8050	800	32	25	19	Single	72	65	60	90	90	90	832	825	819
MDZ D8050	600	32	25	19	Single	72	65	60	90	90	90	632	625	619
MDZ D8050	400	32	25	19	Single	72	65	60	90	90	90	432	425	419

Concealed Fix

MDZ C8050	1500	32	25	19	Single	72	65	60	90	90	90	1532	1525	1519
MDZ C8050	1000	32	25	19	Single	72	65	60	90	90	90	1032	1025	1019
MDZ C8050	800	32	25	19	Single	72	65	60	90	90	90	832	825	819
MDZ C8050	600	32	25	19	Single	72	65	60	90	90	90	632	625	619
MDZ C8050	400	32	25	19	Single	72	65	60	90	90	90	432	425	419

NOTE:

Also available in all fixes

MDZ 8050 Series in 32mm diameter come in fixing centres from 400mm to 2400mm, in 100mm increments.

MDZ 8050 Series in 25mm diameter come in fixing centres from 400mm to 2000mm, in 100mm increments.

MDZ 8050 Series in 19mm diameter come in fixing centres from 400mm to 1500mm, in 100mm increments.



HOW TO SPECIFY

Product No. / Fixing Centres / Square Tube / Finish / Fixing (refer diagram below)

eg: B8050 / 800 / 25 / SSS / TM

B = BACK TO BACK FIX

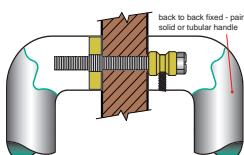

D = DISK FIX

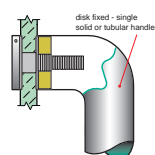

C = CONCEALED FIX

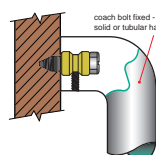

PLEASE SPECIFY DOOR TYPE

GD - Glass doors

TM - Timber doors

AL - Aluminium doors

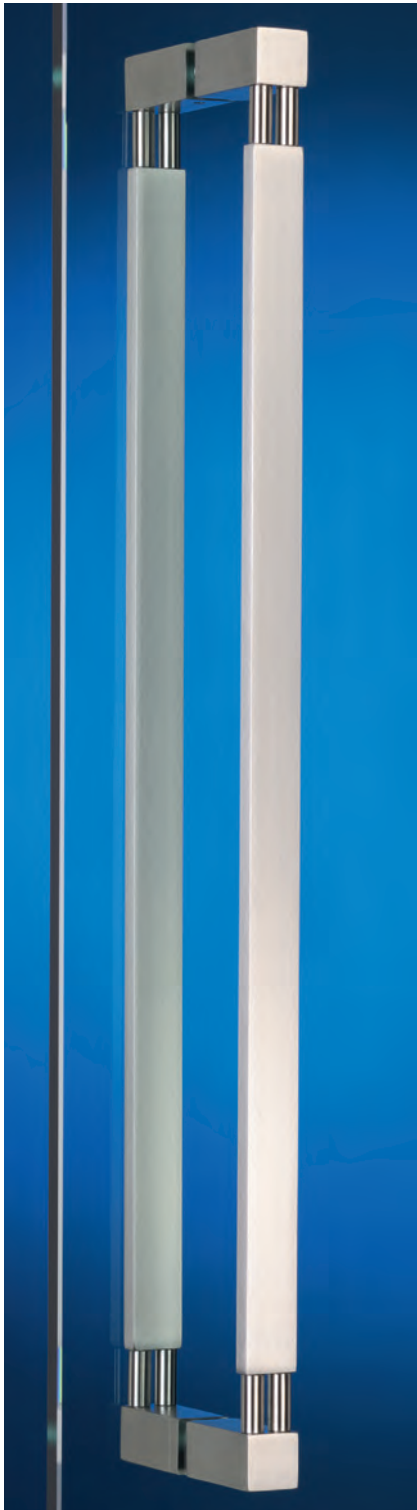

Product No.	Fixing Centres mm	Flat Bar mm	Unit	Projection mm	Overall Length mm
-------------	-------------------	-------------	------	---------------	-------------------

Back to Back Fix

MDZ B8060	800	25x10	Pair	57	825
MDZ B8060	600	25x10	Pair	57	625
MDZ B8060	400	25x10	Pair	57	425

Disk Fix

MDZ D8060	800	25x10	Single	57	825
MDZ D8060	600	25x10	Single	57	625
MDZ D8060	400	25x10	Single	57	425

Concealed Fix

MDZ C8060	800	25x10	Single	57	825
MDZ C8060	600	25x10	Single	57	625
MDZ C8060	400	25x10	Single	57	425

HOW TO SPECIFY

Product No. / Fixing Centres / Flat Bar / Finish / Fixing (refer diagram below)

eg: B8060 / 600 / 25x10 / SSS / TM

B = BACK TO BACK FIX

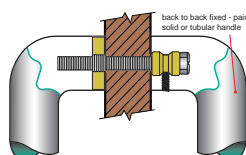

D = DISK FIX

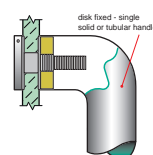

C = CONCEALED FIX

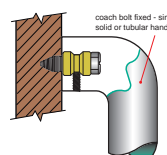

PLEASE SPECIFY DOOR TYPE

GD - Glass doors

TM - Timber doors

AL - Aluminium doors



Product No.	Fixing Centres mm	Flat Bar mm	Unit	Projection mm	Overall Length mm
Back to Back Fix					
MDZ B8070	270	40x8	Pair	53	400
Disk Fix					
MDZ D8070	270	40x8	Single	53	400
Concealed Fix					
MDZ C8070	270	40x8	Single	53	400



HOW TO SPECIFY

Product No. / Fixing Centres / Flat Bar / Finish / Fixing (refer diagram below)

eg: B8070 / 270 / 40x8 / SSS / TM

B = BACK TO BACK FIX

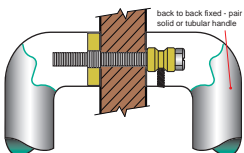

D = DISK FIX

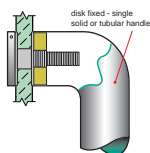

C = CONCEALED FIX

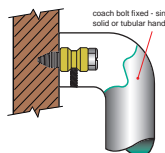

PLEASE SPECIFY DOOR TYPE

GD - Glass doors

TM - Timber doors

AL - Aluminium doors

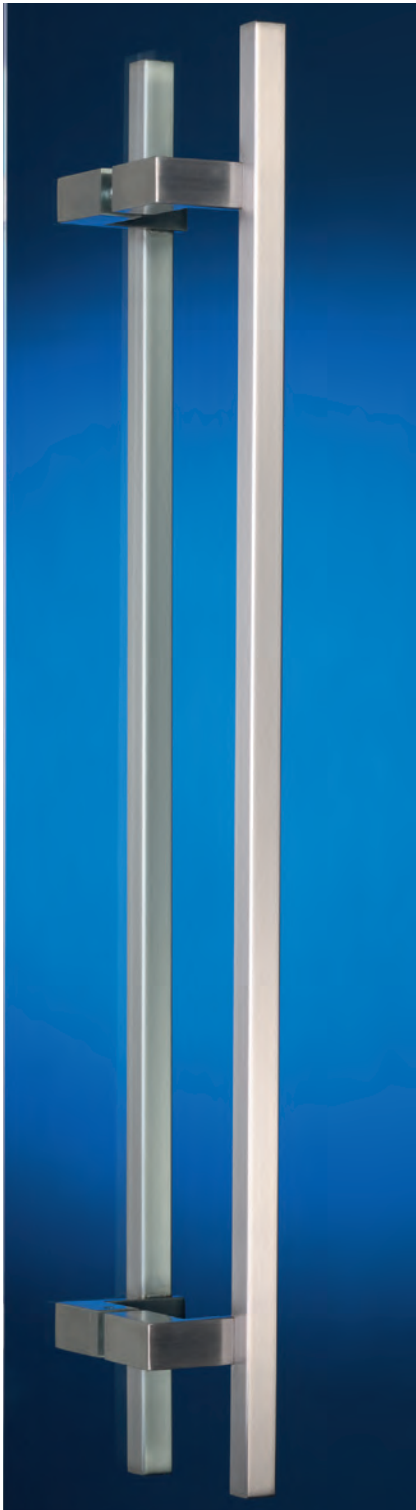

Product No.	Fixing Centres mm	Square Tube mm	Unit	Projection mm	Width mm	Overall Length mm
-------------	-------------------	----------------	------	---------------	----------	-------------------

Back to Back Fix

MDZ B8080	1340	19	Pair	65	75	1500
MDZ B8080	840	19	Pair	65	75	1000
MDZ B8080	640	19	Pair	65	75	800
MDZ B8080	440	19	Pair	65	75	600
MDZ B8080	240	19	Pair	65	75	400

Disk Fix

MDZ D8080	1340	19	Single	65	75	1500
MDZ D8080	840	19	Single	65	75	1000
MDZ D8080	640	19	Single	65	75	800
MDZ D8080	440	19	Single	65	75	600
MDZ D8080	240	19	Single	65	75	400

Concealed Fix

MDZ C8080	1340	19	Single	65	75	1500
MDZ C8080	840	19	Single	65	75	1000
MDZ C8080	640	19	Single	65	75	800
MDZ C8080	440	19	Single	65	75	600
MDZ C8080	240	19	Single	65	75	400

NOTE:
Special sizes available on request



HOW TO SPECIFY

Product No. / Fixing Centres / Square Tube / Finish / Fixing (refer diagram below)

eg: B8080 / 1340 / 19 / SSS / TM

B = BACK TO BACK FIX

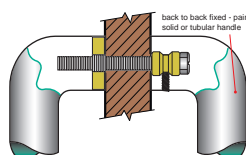

D = DISK FIX

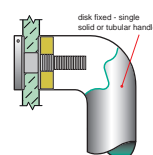

C = CONCEALED FIX

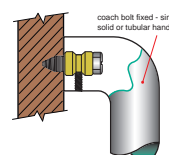

PLEASE SPECIFY DOOR TYPE

GD - Glass doors

TM - Timber doors

AL - Aluminium doors



Product No.	Fixing Centres mm	Tube Diameter mm	Unit	Projection mm	Width mm	Overall Length mm
-------------	-------------------	------------------	------	---------------	----------	-------------------

Back to Back Fix

MDZ B8090	1340	25	Pair	71	75	1500
MDZ B8090	840	25	Pair	71	75	1000
MDZ B8090	640	25	Pair	71	75	800
MDZ B8090	440	25	Pair	71	75	600
MDZ B8090	240	25	Pair	71	75	400

Disk Fix

MDZ D8090	1340	25	Single	71	75	1500
MDZ D8090	840	25	Single	71	75	1000
MDZ D8090	640	25	Single	71	75	800
MDZ D8090	440	25	Single	71	75	600
MDZ D8090	240	25	Single	71	75	400

Concealed Fix

MDZ C8090	1340	25	Single	71	75	1500
MDZ C8090	840	25	Single	71	75	1000
MDZ C8090	640	25	Single	71	75	800
MDZ C8090	440	25	Single	71	75	600
MDZ C8090	240	25	Single	71	75	400

NOTE:
Special sizes available on request



HOW TO SPECIFY

Product No. / Fixing Centres / Tube Diameter / Finish / Fixing (refer diagram below)

eg: B8090 / 440 / 25 / SSS / TM

B = BACK TO BACK FIX

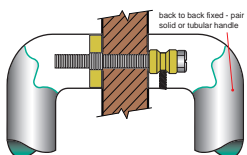

D = DISK FIX

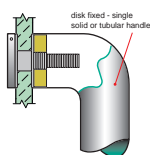

C = CONCEALED FIX

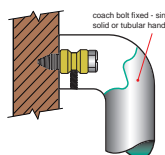

PLEASE SPECIFY DOOR TYPE
GD - Glass doors
TM - Timber doors
AL - Aluminium doors



Product No.	Fixing Centres mm	Flat Bar mm	Unit	Projection mm	Overall Length mm
Back to Back Fix					
MDZ B8100	600	40x10	Pair	65	645
Disk Fix					
MDZ D8100	600	40x10	Single	65	645
Concealed Fix					
MDZ C8100	600	40x10	Single	65	645

HOW TO SPECIFY

Product No. / Fixing Centres / Flat Bar / Finish / Fixing (refer diagram below)
 eg: B8100 / 600 / 40x10 / SSS / TM

B = BACK TO BACK FIX

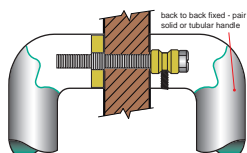

D = DISK FIX

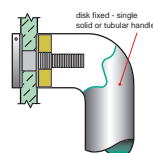

C = CONCEALED FIX

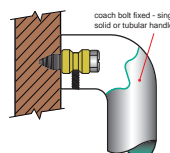

PLEASE SPECIFY DOOR TYPE
 GD - Glass doors
 TM - Timber doors
 AL - Aluminium doors

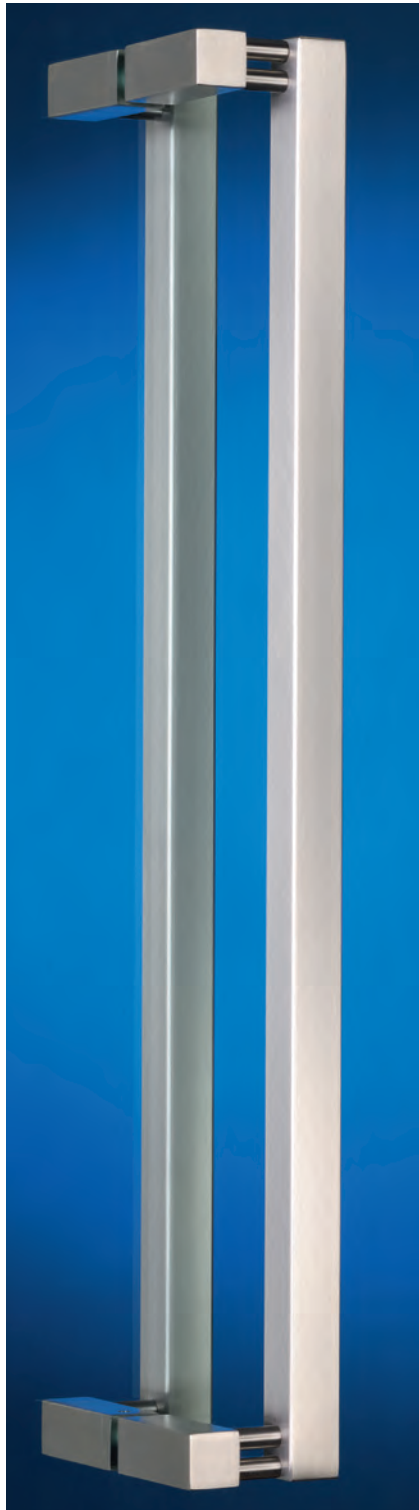

Product No.	Fixing Centres mm	Square Tube mm	Unit	Projection mm	Width mm	Overall Length mm
-------------	-------------------	----------------	------	---------------	----------	-------------------

Back to Back Fix

MDZ B8110	1500	25	Pair	65	75	1525
MDZ B8110	1000	25	Pair	65	75	1025
MDZ B8110	800	25	Pair	65	75	825
MDZ B8110	600	25	Pair	65	75	625
MDZ B8110	400	25	Pair	65	75	425

Disk Fix

MDZ D8110	1500	25	Single	65	75	1525
MDZ D8110	1000	25	Single	65	75	1025
MDZ D8110	800	25	Single	65	75	825
MDZ D8110	600	25	Single	65	75	625
MDZ D8110	400	25	Single	65	75	425

Concealed Fix

MDZ C8110	1500	25	Single	65	75	1525
MDZ C8110	1000	25	Single	65	75	1025
MDZ C8110	800	25	Single	65	75	825
MDZ C8110	600	25	Single	65	75	625
MDZ C8110	400	25	Single	65	75	425

NOTE:
Special sizes available on request

HOW TO SPECIFY

Product No. / Fixing Centres / Square Tube / Finish / Fixing (refer diagram below)

eg: B8110 / 800 / 25 / SSS / TM

B = BACK TO BACK FIX

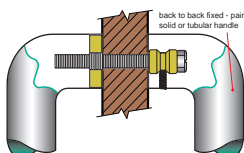

D = DISK FIX

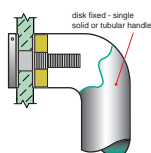

C = CONCEALED FIX

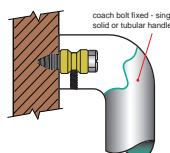

PLEASE SPECIFY DOOR TYPE
GD - Glass doors
TM - Timber doors
AL - Aluminium doors

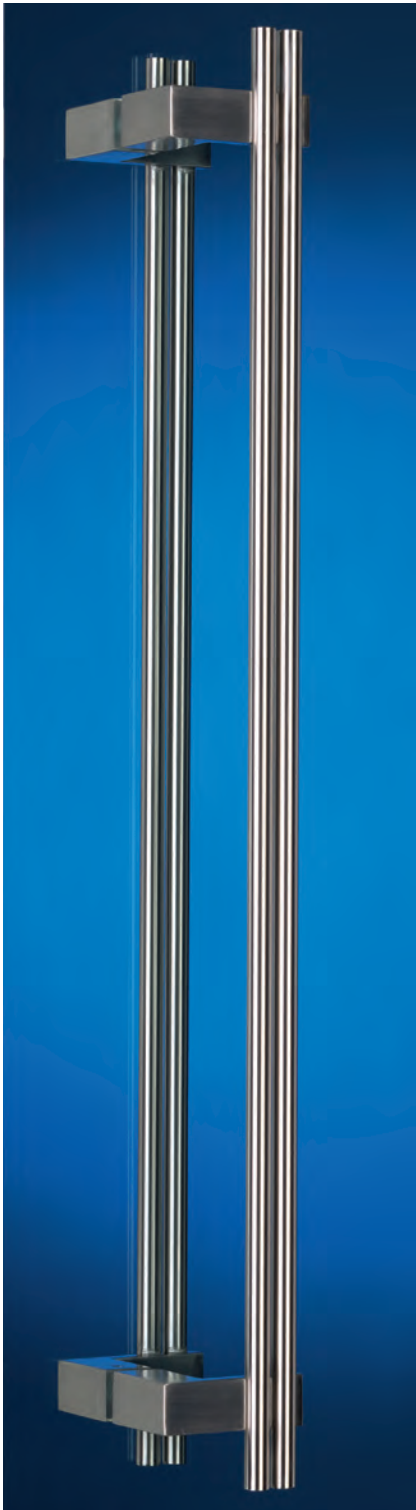

Product No.	Fixing Centres mm	Rod Diameter mm	Unit	Projection mm	Width mm	Overall Length mm
-------------	-------------------	-----------------	------	---------------	----------	-------------------

Back to Back Fix

MDZ B8120	720	12	Pair	56	75	800
MDZ B8120	520	12	Pair	56	75	600
MDZ B8120	320	12	Pair	56	75	400

Disk Fix

MDZ D8120	720	12	Single	56	75	800
MDZ D8120	520	12	Single	56	75	600
MDZ D8120	320	12	Single	56	75	400

Concealed Fix

MDZ C8120	720	12	Single	56	75	800
MDZ C8120	520	12	Single	56	75	600
MDZ C8120	320	12	Single	56	75	400

NOTE:
Special sizes available on request



HOW TO SPECIFY

Product No. / Fixing Centres / Rod Diameter / Finish / Fixing (refer diagram below)

eg: B8120 / 320 / 12 / SSS / TM

B = BACK TO BACK FIX

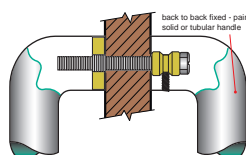

D = DISK FIX

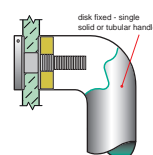

C = CONCEALED FIX

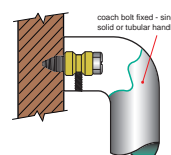

PLEASE SPECIFY DOOR TYPE

GD - Glass doors

TM - Timber doors

AL - Aluminium doors

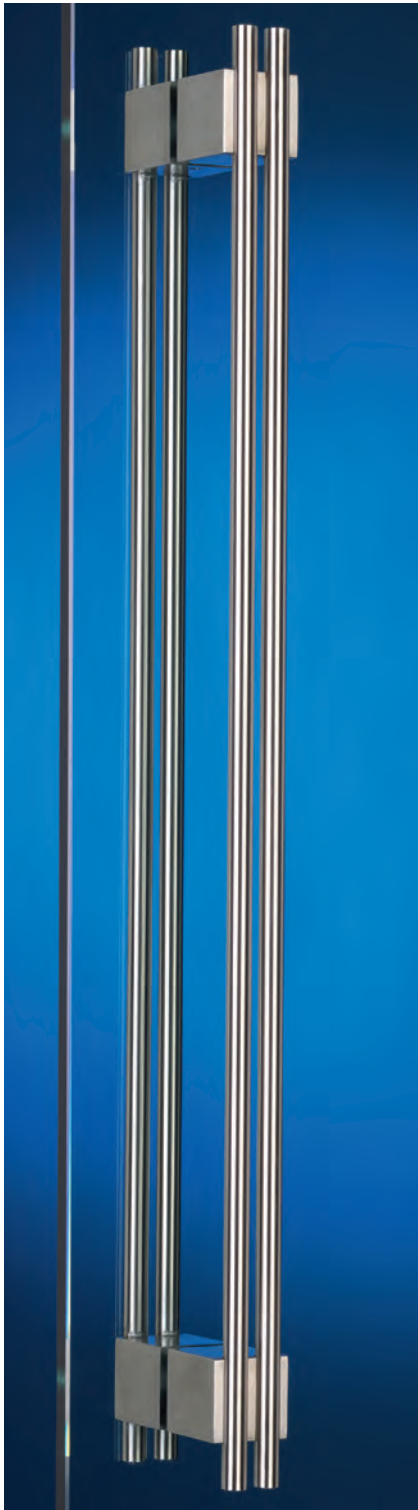

Product No.	Fixing Centres mm	Rod Diameter mm	Unit	Projection mm	Overall Length mm
-------------	-------------------	-----------------	------	---------------	-------------------

Back to Back Fix

MDZ B8130	720	12	Pair	55	800
MDZ B8130	520	12	Pair	55	600
MDZ B8130	320	12	Pair	55	400

Disk Fix

MDZ D8130	720	12	Single	55	800
MDZ D8130	520	12	Single	55	600
MDZ D8130	320	12	Single	55	400

Concealed Fix

MDZ C8130	720	12	Single	55	800
MDZ C8130	520	12	Single	55	600
MDZ C8130	320	12	Single	55	400

NOTE:
Special sizes available on request



HOW TO SPECIFY

Product No. / Fixing Centres / Rod Diameter / Finish / Fixing (refer diagram below)

eg: B8130 / 720 / 12 / SSS / TM

B = BACK TO BACK FIX

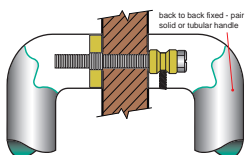

D = DISK FIX

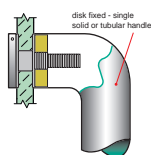

C = CONCEALED FIX

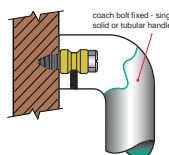

PLEASE SPECIFY DOOR TYPE

GD - Glass doors

TM - Timber doors

AL - Aluminium doors

Entry Door Pull Handle Design Registration No.148052 Copyright Reserved

Material 316 Marine Grade Stainless Steel

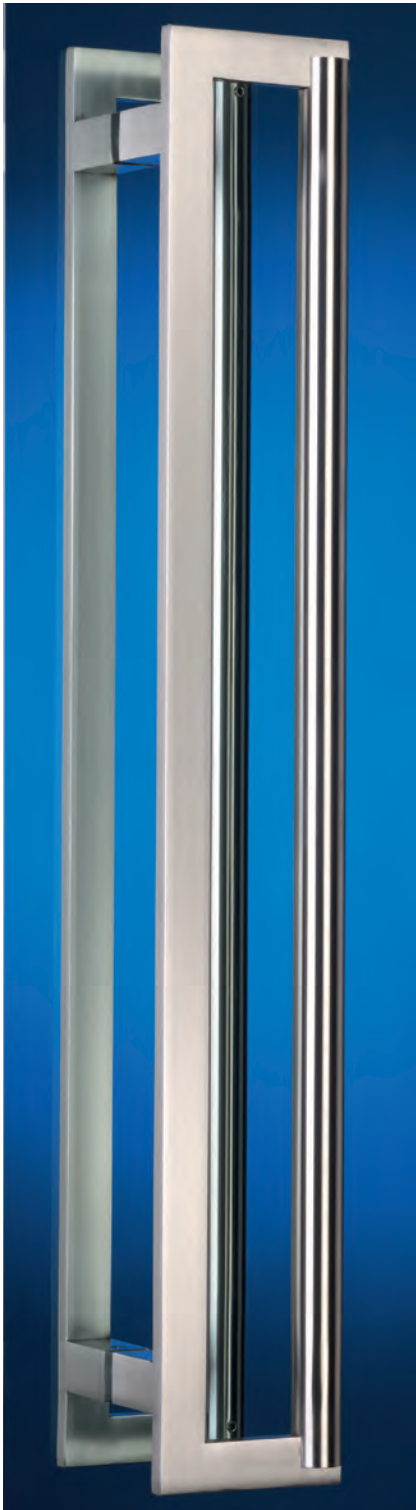

Product No.	Fixing Centres mm	Tube Diameter mm	Unit	Projection mm	Width mm	Overall Length mm
Back to Back Fix						
MDZ B8140	400	25	Pair	60	100	500
Disk Fix						
MDZ D8140	400	25	Single	60	100	500
Concealed Fix						
MDZ C8140	400	25	Single	60	100	500

NOTE:

Flat bar measures 25mm x 10mm
Special sizes available on request



HOW TO SPECIFY

Product No. / Fixing Centres / Tube Diameter / Finish / Fixing (refer diagram below)

eg: B8140 / 400 / 25 / SSS / TM

B = BACK TO BACK FIX

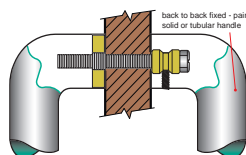

D = DISK FIX

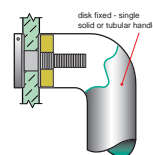

C = CONCEALED FIX

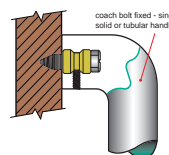

PLEASE SPECIFY DOOR TYPE

GD - Glass doors

TM - Timber doors

AL - Aluminium doors

Entry Door Pull Handle

Material 316 Marine Grade Stainless Steel

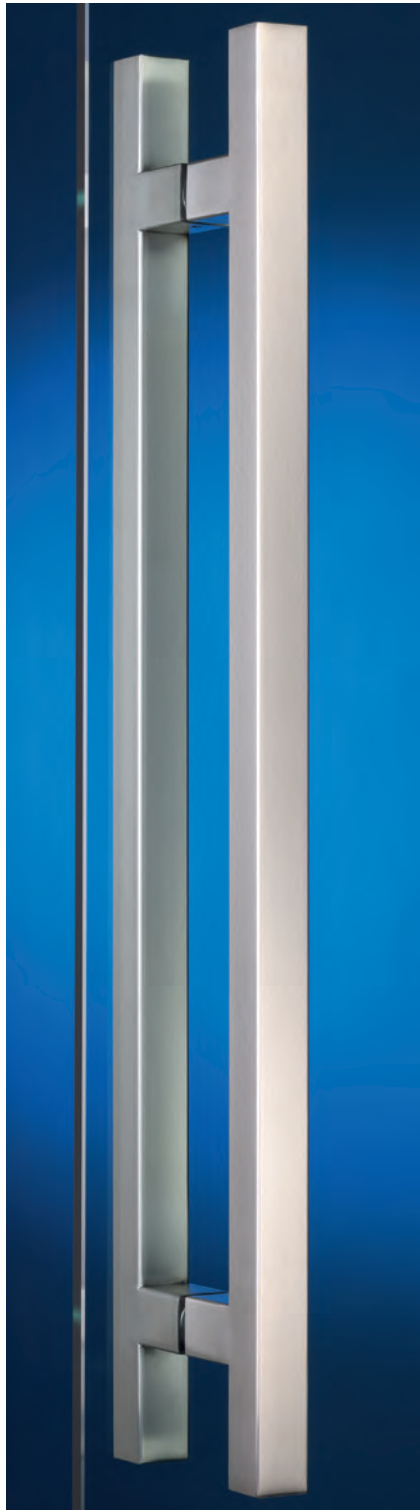

Product No.	Fixing Centres mm	Square Tube mm			Unit	Projection mm			Overall Length mm
-------------	-------------------	----------------	--	--	------	---------------	--	--	-------------------

Back to Back Fix

MDZ B8150	1340	32	25	19	Pair	77	70	65	1500
MDZ B8150	840	32	25	19	Pair	77	70	65	1000
MDZ B8150	640	32	25	19	Pair	77	70	65	800
MDZ B8150	440	32	25	19	Pair	77	70	65	600
MDZ B8150	240	32	25	19	Pair	77	70	65	400

Disk Fix

MDZ D8150	1340	32	25	19	Single	77	70	65	1500
MDZ D8150	840	32	25	19	Single	77	70	65	1000
MDZ D8150	640	32	25	19	Single	77	70	65	800
MDZ D8150	440	32	25	19	Single	77	70	65	600
MDZ D8150	240	32	25	19	Single	77	70	65	400

Concealed Fix

MDZ C8150	1340	32	25	19	Single	77	70	65	1500
MDZ C8150	840	32	25	19	Single	77	70	65	1000
MDZ C8150	640	32	25	19	Single	77	70	65	800
MDZ C8150	440	32	25	19	Single	77	70	65	600
MDZ C8150	240	32	25	19	Single	77	70	65	400

NOTE:
Special sizes available on request



HOW TO SPECIFY

Product No. / Fixing Centres / Square Tube / Finish / Fixing (refer diagram below)

eg: B8150 / 840 / 32 / SSS / TM

B = BACK TO BACK FIX

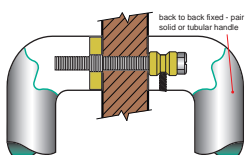

D = DISK FIX

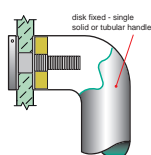

C = CONCEALED FIX

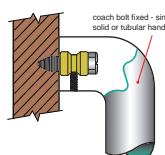

PLEASE SPECIFY DOOR TYPE

GD - Glass doors

TM - Timber doors

AL - Aluminium doors

Entry Door Pull Handle

Material 316 Marine Grade Stainless Steel

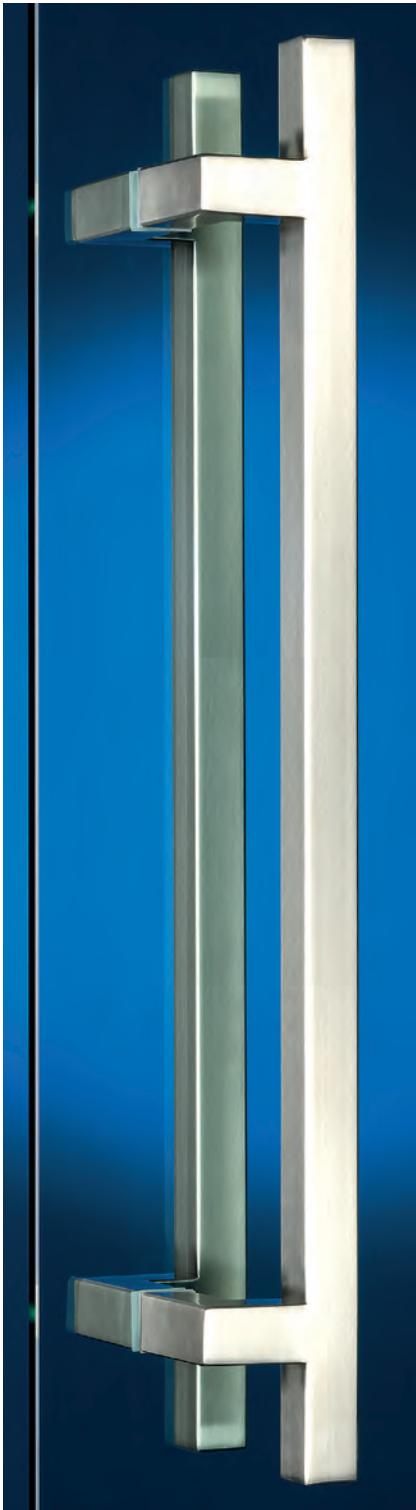

Product No.	Fixing Centres mm	Square Tube mm			Unit	Projection mm			Overall Length mm
Back to Back Fix									
MDZ B8155/E	1840	32	25	19	Pair	77	70	65	2000
MDZ B8155/F	1740	32	25	19	Pair	77	70	65	1900
MDZ B8155/G	1640	32	25	19	Pair	77	70	65	1800
MDZ B8155/H	1540	32	25	19	Pair	77	70	65	1700
MDZ B8155/I	1440	32	25	19	Pair	77	70	65	1600
MDZ B8155/J	1340	32	25	19	Pair	77	70	65	1500
MDZ B8155/K	1240	32	25	19	Pair	77	70	65	1400
MDZ B8155/L	1140	32	25	19	Pair	77	70	65	1300
MDZ B8155/M	1040	32	25	19	Pair	77	70	65	1200
MDZ B8155/N	940	32	25	19	Pair	77	70	65	1100
MDZ B8155/O	840	32	25	19	Pair	77	70	65	1000
MDZ B8155/P	740	32	25	19	Pair	77	70	65	900
MDZ B8155/Q	640	32	25	19	Pair	77	70	65	800
MDZ B8155/R	540	32	25	19	Pair	77	70	65	700
MDZ B8155/S	440	32	25	19	Pair	77	70	65	600
MDZ B8155/T	340	32	25	19	Pair	77	70	65	500
MDZ B8155/U	240	32	25	19	Pair	77	70	65	400

NOTE:
Special sizes available on request



HOW TO SPECIFY

Product No. / Fixing Centres / Square Tube / Finish / Fixing (refer diagram below)

eg: B8155 / 1840 / 32 / SSS / TM

B = BACK TO BACK FIX

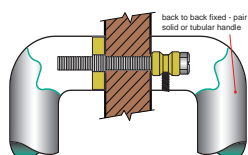

D = DISK FIX

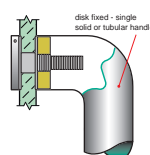

C = CONCEALED FIX

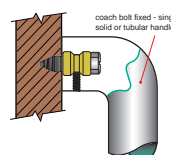

PLEASE SPECIFY DOOR TYPE

GD - Glass doors

TM - Timber doors

AL - Aluminium doors



Product No.	Fixing Centres mm	Tube Diameter mm	Unit	Projection mm	Width mm	Overall Length mm
Back to Back Fix						
MDZ B8160	1500	25	Pair	70	90	1525
MDZ B8160	1000	25	Pair	70	90	1025
MDZ B8160	800	25	Pair	70	90	825
MDZ B8160	600	25	Pair	70	90	625
Disk Fix						
MDZ D8160	1500	25	Single	70	90	1525
MDZ D8160	1000	25	Single	70	90	1025
MDZ D8160	800	25	Single	70	90	825
MDZ D8160	600	25	Single	70	90	625
Concealed Fix						
MDZ C8160	1500	25	Single	70	90	1525
MDZ C8160	1000	25	Single	70	90	1025
MDZ C8160	800	25	Single	70	90	825
MDZ C8160	600	25	Single	70	90	625

HOW TO SPECIFY

Product No. / Fixing Centres / Tube Diameter / Finish / Fixing (refer diagram below)

eg: B8160 / 800 / 25 / SSS / TM

B = BACK TO BACK FIX

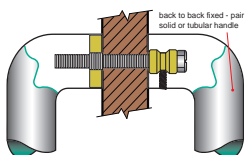

D = DISK FIX

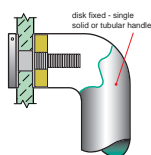

C = CONCEALED FIX

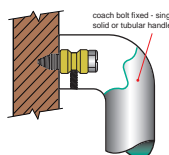

PLEASE SPECIFY DOOR TYPE

GD - Glass doors

TM - Timber doors

AL - Aluminium doors

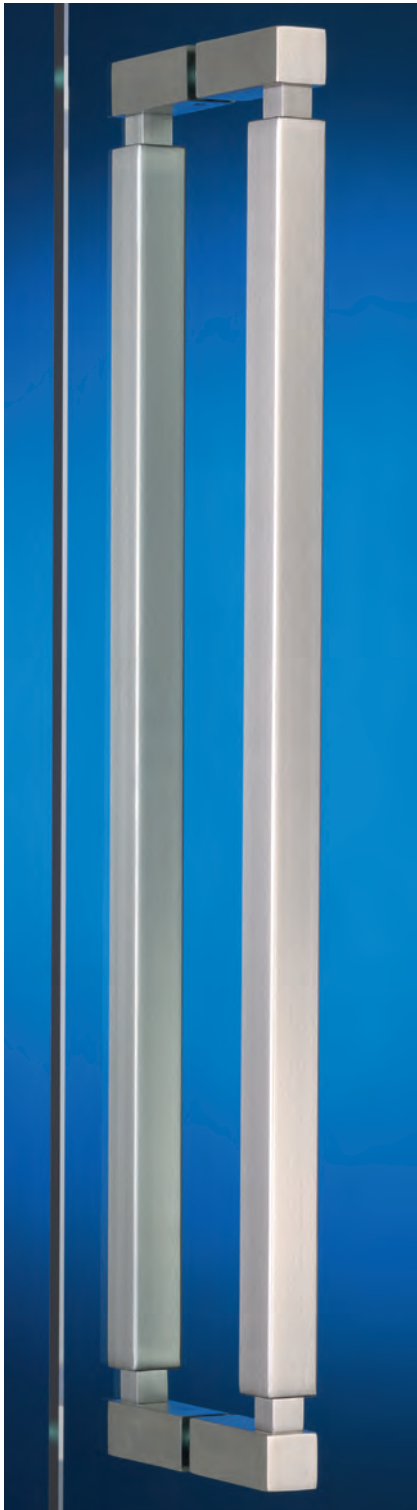

Product No.	Fixing Centres mm	Square Tube mm			Unit	Projection mm			Overall Length mm		
-------------	-------------------	----------------	--	--	------	---------------	--	--	-------------------	--	--

Back to Back Fix

MDZ B8170	1500	32	25	19	Pair	77	70	65	1532	1525	1519
MDZ B8170	1000	32	25	19	Pair	77	70	65	1032	1025	1019
MDZ B8170	800	32	25	19	Pair	77	70	65	832	825	819
MDZ B8170	600	32	25	19	Pair	77	70	65	632	625	619
MDZ B8170	400	32	25	19	Pair	77	70	65	432	425	419

Disk Fix

MDZ D8170	1500	32	25	19	Single	77	70	65	1532	1525	1519
MDZ D8170	1000	32	25	19	Single	77	70	65	1032	1025	1019
MDZ D8170	800	32	25	19	Single	77	70	65	832	825	819
MDZ D8170	600	32	25	19	Single	77	70	65	632	625	619
MDZ D8170	400	32	25	19	Single	77	70	65	432	425	419

Concealed Fix

MDZ C8170	1500	32	25	19	Single	77	70	65	1532	1525	1519
MDZ C8170	1000	32	25	19	Single	77	70	65	1032	1025	1019
MDZ C8170	800	32	25	19	Single	77	70	65	832	825	819
MDZ C8170	600	32	25	19	Single	77	70	65	632	625	619
MDZ C8170	400	32	25	19	Single	77	70	65	432	425	419

NOTE:
Special sizes available on request

HOW TO SPECIFY

Product No. / Fixing Centres / Square Tube / Finish / Fixing (refer diagram below)

eg: B8170 / 1000 / 25 / SSS / TM

B = BACK TO BACK FIX

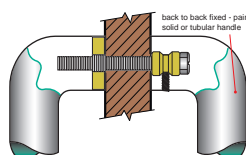

D = DISK FIX

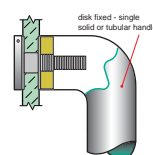

C = CONCEALED FIX

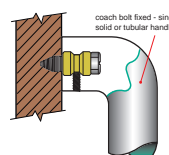

PLEASE SPECIFY DOOR TYPE

GD - Glass doors

TM - Timber doors

AL - Aluminium doors

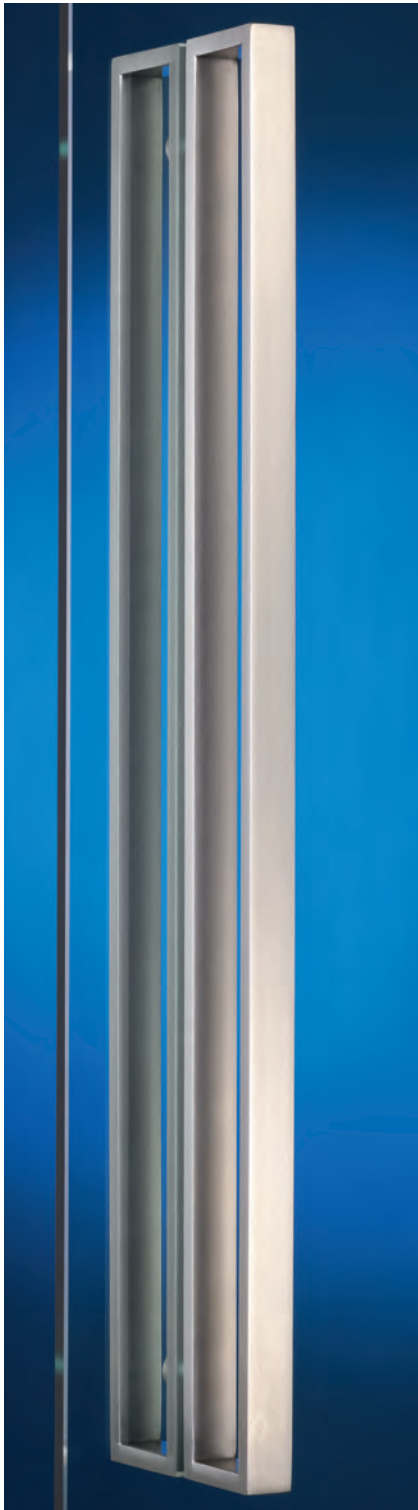

Product No.	Fixing Centres mm	Flat Bar mm	Unit	Projection mm	Overall Length mm
Back to Back Fix					
MDZ B8180	500	25x10	Pair	65	600
Disk Fix					
MDZ D8180	500	25x10	Single	65	600

HOW TO SPECIFY

Product No. / Fixing Centres / Flat Bar / Finish / Fixing (refer diagram below)

eg: B8180 / 500 / 25 / SSS / TM

B = BACK TO BACK FIX

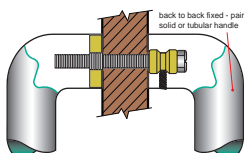

D = DISK FIX

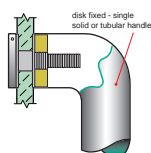

C = CONCEALED FIX

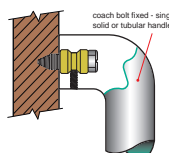

PLEASE SPECIFY DOOR TYPE

GD - Glass doors

TM - Timber doors

AL - Aluminium doors



Product No.	Fixing Centres mm	Tube Diameter mm		Unit	Projection mm		Width mm		Overall Length mm	
-------------	-------------------	------------------	--	------	---------------	--	----------	--	-------------------	--

Back to Back Fix

MDZ B8190	1500	32	25	Pair	72	65	100	100	1532	1525
MDZ B8190	1000	32	25	Pair	72	65	100	100	1032	1025
MDZ B8190	800	32	25	Pair	72	65	100	100	832	825
MDZ B8190	600	32	25	Pair	72	65	100	100	632	625
MDZ B8190	400	32	25	Pair	72	65	100	100	432	425

Disk Fix

MDZ D8190	1500	32	25	Single	72	65	100	100	1532	1525
MDZ D8190	1000	32	25	Single	72	65	100	100	1032	1025
MDZ D8190	800	32	25	Single	72	65	100	100	832	825
MDZ D8190	600	32	25	Single	72	65	100	100	632	625
MDZ D8190	400	32	25	Single	72	65	100	100	432	425

Concealed Fix

MDZ C8190	1500	32	25	Single	72	65	100	100	1532	1525
MDZ C8190	1000	32	25	Single	72	65	100	100	1032	1025
MDZ C8190	800	32	25	Single	72	65	100	100	832	825
MDZ C8190	600	32	25	Single	72	65	100	100	632	625
MDZ C8190	400	32	25	Single	72	65	100	100	432	425

NOTE:
Special sizes available on request



HOW TO SPECIFY

Product No. / Fixing Centres / Tube Diameter / Finish / Fixing (refer diagram below)

eg: B8190 / 1000 / 32 / SSS / TM

B = BACK TO BACK FIX

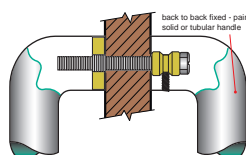

D = DISK FIX

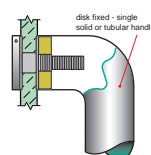

C = CONCEALED FIX

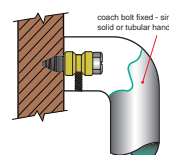

PLEASE SPECIFY DOOR TYPE

GD - Glass doors

TM - Timber doors

AL - Aluminium doors

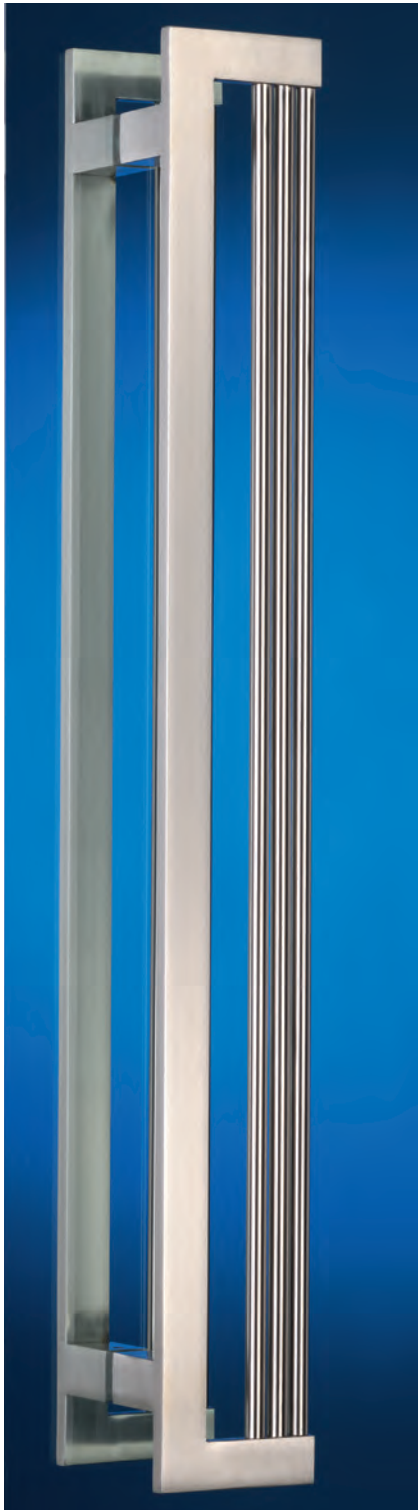

Product No.	Fixing Centres mm	Rod Diameter mm	Unit	Projection mm	Width mm	Overall Length mm
Back to Back Fix						
MDZ B8200	400	10	Pair	50	110	500
Disk Fix						
MDZ D8200	400	10	Single	50	110	500
Concealed Fix						
MDZ C8200	400	10	Single	50	110	500

NOTE:
Flat bar measures 25mm x 10mm

HOW TO SPECIFY

Product No. / Fixing Centres / Rod Diameter / Finish / Fixing (refer diagram below)
eg: B8200 / 400 / 10 / SSS / TM

B = BACK TO BACK FIX

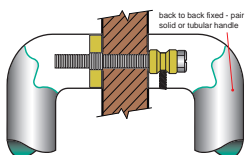

D = DISK FIX

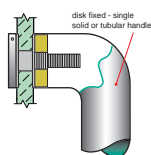

C = CONCEALED FIX

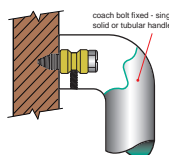

PLEASE SPECIFY DOOR TYPE
GD - Glass doors
TM - Timber doors
AL - Aluminium doors

Entry Door Pull Handle

Material 316 Marine Grade Stainless Steel



Product No.	Fixing Centres mm	Tube Diameter mm	Unit	Projection mm	Overall Length mm
-------------	-------------------	------------------	------	---------------	-------------------

Back to Back Fix

MDZ B8210	1500	32	25	Pair	77	70	1532	1525
MDZ B8210	1000	32	25	Pair	77	70	1032	1025
MDZ B8210	800	32	25	Pair	77	70	832	825
MDZ B8210	600	32	25	Pair	77	70	632	625
MDZ B8210	400	32	25	Pair	77	70	432	425

Disk Fix

MDZ D8210	1500	32	25	Single	77	70	1532	1525
MDZ D8210	1000	32	25	Single	77	70	1032	1025
MDZ D8210	800	32	25	Single	77	70	832	825
MDZ D8210	600	32	25	Single	77	70	632	625
MDZ D8210	400	32	25	Single	77	70	432	425

Concealed Fix

MDZ C8210	1500	32	25	Single	77	70	1532	1525
MDZ C8210	1000	32	25	Single	77	70	1032	1025
MDZ C8210	800	32	25	Single	77	70	832	825
MDZ C8210	600	32	25	Single	77	70	632	625
MDZ C8210	400	32	25	Single	77	70	432	425

NOTE:
Special sizes available on request



HOW TO SPECIFY

Product No. / Fixing Centres / Tube Diameter / Finish / Fixing (refer diagram below)

eg: B8210 / 600 / 32 / SSS / TM

B = BACK TO BACK FIX

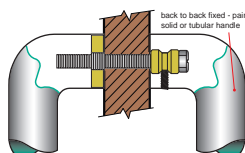

D = DISK FIX

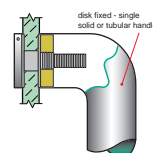

C = CONCEALED FIX

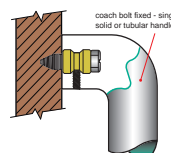

PLEASE SPECIFY DOOR TYPE
GD - Glass doors
TM - Timber doors
AL - Aluminium doors



Product No.	Fixing Centres mm	Tube Diameter mm	Unit	Projection mm	Width mm	Overall Length mm
Back to Back Fix						
MDZ B8220	600	25	Pair	65	175	632
Disk Fix						
MDZ D8220	600	25	Single	65	175	632
Concealed Fix						
MDZ C8220	600	25	Single	65	175	632

Entry Door Pull Handle

Material 316 Marine Grade Stainless Steel

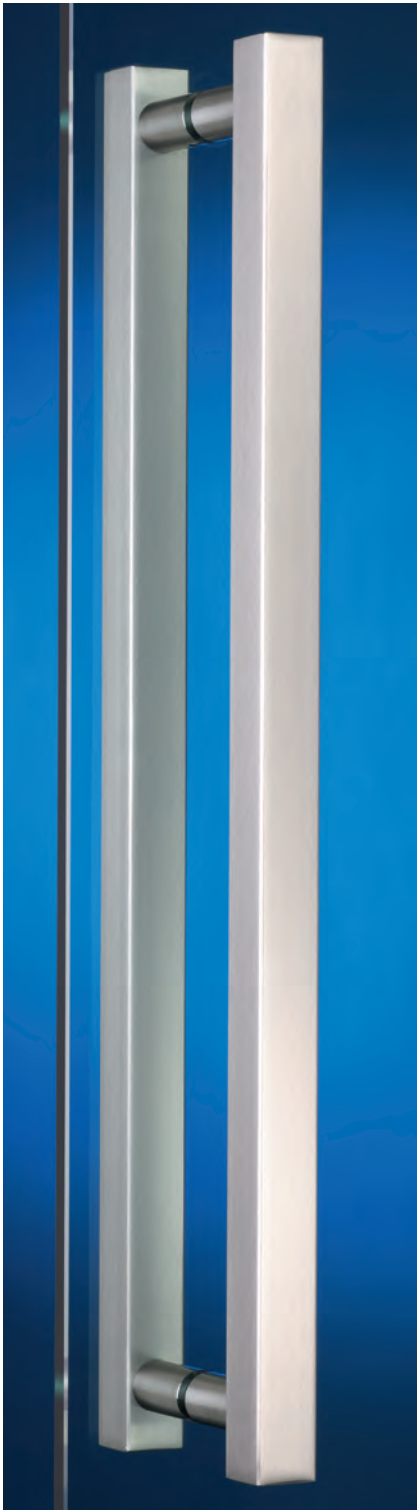

Product No.	Fixing Centres mm	Square Tube mm	Round Standoff Dia. mm	Unit	Projection mm	Overall Length mm
-------------	-------------------	----------------	------------------------	------	---------------	-------------------

Back to Back Fix

MDZ B8230	1940	32	25	25	19	Pair	76	69	2000
MDZ B8230	1440	32	25	25	19	Pair	76	69	1500
MDZ B8230	940	32	25	25	19	Pair	76	69	1000
MDZ B8230	740	32	25	25	19	Pair	76	69	800
MDZ B8230	540	32	25	25	19	Pair	76	69	600
MDZ B8230	340	32	25	25	19	Pair	76	69	400

Disk Fix

MDZ D8230	1940	32	25	25	19	Single	76	69	2000
MDZ D8230	1440	32	25	25	19	Single	76	69	1500
MDZ D8230	940	32	25	25	19	Single	76	69	1000
MDZ D8230	740	32	25	25	19	Single	76	69	800
MDZ D8230	540	32	25	25	19	Single	76	69	600
MDZ D8230	340	32	25	25	19	Single	76	69	400

Concealed Fix

MDZ C8230	1940	32	25	25	19	Single	76	69	2000
MDZ C8230	1440	32	25	25	19	Single	76	69	1500
MDZ C8230	940	32	25	25	19	Single	76	69	1000
MDZ C8230	740	32	25	25	19	Single	76	69	800
MDZ C8230	540	32	25	25	19	Single	76	69	600
MDZ C8230	340	32	25	25	19	Single	76	69	400

NOTE:
Special sizes available on request



HOW TO SPECIFY

Product No. / Fixing Centres / Square Tube / Finish / Fixing (refer diagram below)

eg: B8230 / 940 / 25 / SSS / TM

B = BACK TO BACK FIX

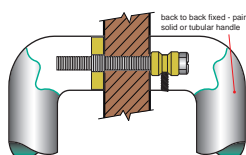

D = DISK FIX

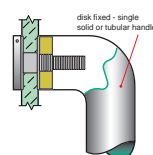

C = CONCEALED FIX

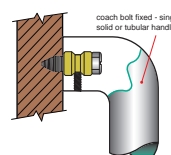

PLEASE SPECIFY DOOR TYPE

GD - Glass doors

TM - Timber doors

AL - Aluminium doors

Entry Door Pull Handle

Material 316 Marine Grade Stainless Steel



Product No.	Fixing Centres mm	Tube Diameter mm	Unit	Projection mm	Overall Length mm
-------------	-------------------	------------------	------	---------------	-------------------

Back to Back Fix

MDZ B8240	1870	32	25	Pair	80	74	2016
MDZ B8240	1370	32	25	Pair	80	74	1516
MDZ B8240	870	32	25	Pair	80	74	1016
MDZ B8240	670	32	25	Pair	80	74	816
MDZ B8240	470	32	25	Pair	80	74	616
MDZ B8240	270	32	25	Pair	80	74	416

Disk Fix

MDZ D8240	1870	32	25	Single	80	74	2016
MDZ D8240	1370	32	25	Single	80	74	1516
MDZ D8240	870	32	25	Single	80	74	1016
MDZ D8240	670	32	25	Single	80	74	816
MDZ D8240	470	32	25	Single	80	74	616
MDZ D8240	270	32	25	Single	80	74	416

Concealed Fix

MDZ C8240	1870	32	25	Single	80	74	2016
MDZ C8240	1370	32	25	Single	80	74	1516
MDZ C8240	870	32	25	Single	80	74	1016
MDZ C8240	670	32	25	Single	80	74	816
MDZ C8240	470	32	25	Single	80	74	616
MDZ C8240	270	32	25	Single	80	74	416

NOTE:
Special sizes available on request



HOW TO SPECIFY

Product No. / Fixing Centres / Tube Diameter / Finish / Fixing (refer diagram below)

eg: B8240 / 870 / 25 / SSS / TM

B = BACK TO BACK FIX

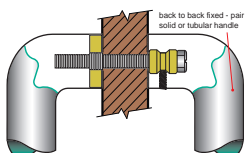

D = DISK FIX

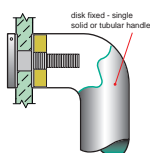

C = CONCEALED FIX

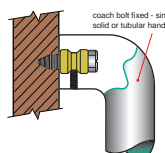

PLEASE SPECIFY DOOR TYPE

GD - Glass doors

TM - Timber doors

AL - Aluminium doors

Entry Door Pull Handle

Material 316 Marine Grade Stainless Steel

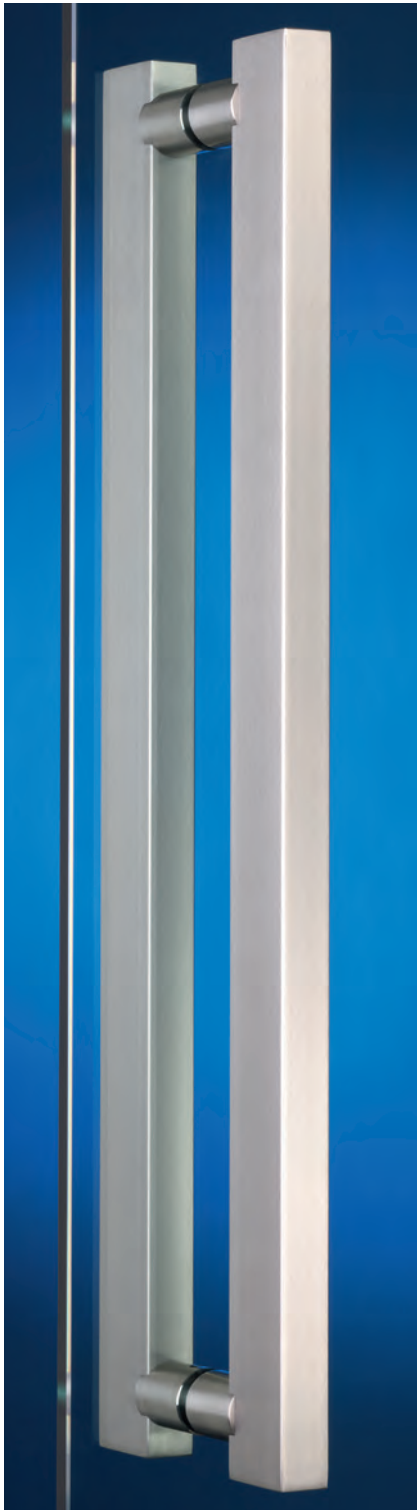

Product No.	Fixing Centres mm	Section Tube mm	Unit	Projection mm	Overall Length mm
-------------	-------------------	-----------------	------	---------------	-------------------

Back to Back Fix

MDZ B8250	1940	25x50	Pair	85	2000
MDZ B8250	1440	25x50	Pair	85	1500
MDZ B8250	940	25x50	Pair	85	1000
MDZ B8250	740	25x50	Pair	85	800
MDZ B8250	540	25x50	Pair	85	600
MDZ B8250	340	25x50	Pair	85	400

Disk Fix

MDZ D8250	1940	25x50	Single	85	2000
MDZ D8250	1440	25x50	Single	85	1500
MDZ D8250	940	25x50	Single	85	1000
MDZ D8250	740	25x50	Single	85	800
MDZ D8250	540	25x50	Single	85	600
MDZ D8250	340	25x50	Single	85	400

Concealed Fix

MDZ C8250	1940	25x50	Single	85	2000
MDZ C8250	1440	25x50	Single	85	1500
MDZ C8250	940	25x50	Single	85	1000
MDZ C8250	740	25x50	Single	85	800
MDZ C8250	540	25x50	Single	85	600
MDZ C8250	340	25x50	Single	85	400

NOTE:
Special sizes available on request



HOW TO SPECIFY

Product No. / Fixing Centres / Section Tube / Finish / Fixing (refer diagram below)

eg: B8250 / 940 / 25x50 / SSS / TM

B = BACK TO BACK FIX

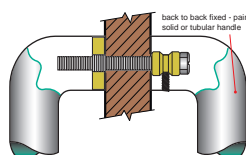

D = DISK FIX

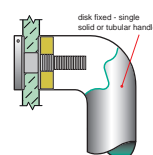

C = CONCEALED FIX

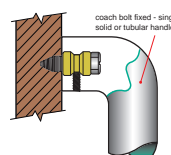

PLEASE SPECIFY DOOR TYPE

GD - Glass doors

TM - Timber doors

AL - Aluminium doors

Entry Door Pull Handle

Material 316 Marine Grade Stainless Steel



Product No.	Fixing Centres mm	Tube Diameter mm	Unit	Projection mm	Overall Length mm
-------------	-------------------	------------------	------	---------------	-------------------

Back to Back Fix

MDZ B8260	1900	38	Pair	95	2000
MDZ B8260	1400	38	Pair	95	1500
MDZ B8260	900	38	Pair	95	1000
MDZ B8260	700	38	Pair	95	800
MDZ B8260	600	38	Pair	95	700
MDZ B8260	400	38	Pair	95	500

Disk Fix

MDZ D8260	1900	38	Single	95	2000
MDZ D8260	1400	38	Single	95	1500
MDZ D8260	900	38	Single	95	1000
MDZ D8260	700	38	Single	95	800
MDZ D8260	600	38	Single	95	700
MDZ D8260	400	38	Single	95	500

Concealed Fix

MDZ C8260	1900	38	Single	95	2000
MDZ C8260	1400	38	Single	95	1500
MDZ C8260	900	38	Single	95	1000
MDZ C8260	700	38	Single	95	800
MDZ C8260	600	38	Single	95	700
MDZ C8260	400	38	Single	95	500

NOTE:
Square legs measure 32mm x 32mm
Special sizes available on request



HOW TO SPECIFY

Product No. / Fixing Centres / Tube Diameter / Finish / Fixing (refer diagram below)

eg: B8260 / 1900 / 38 / SSS / TM

B = BACK TO BACK FIX

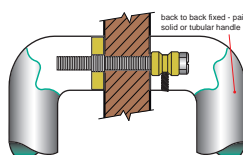

D = DISK FIX

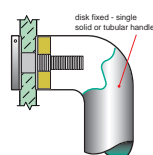

C = CONCEALED FIX

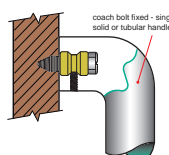

PLEASE SPECIFY DOOR TYPE
GD - Glass doors
TM - Timber doors
AL - Aluminium doors

Entry Door Pull Handle

Material 316 Marine Grade Stainless Steel



Product No.	Fixing Centres mm	Tube Diameter mm	Unit	Projection mm	Overall Length mm
-------------	-------------------	------------------	------	---------------	-------------------

Back to Back Fix

MDZ B8270	1900	38	Pair	83	2000
MDZ B8270	1400	38	Pair	83	1500
MDZ B8270	900	38	Pair	83	1000
MDZ B8270	700	38	Pair	83	800
MDZ B8270	600	38	Pair	83	700
MDZ B8270	400	38	Pair	83	500

Disk Fix

MDZ D8270	1900	38	Single	83	2000
MDZ D8270	1400	38	Single	83	1500
MDZ D8270	900	38	Single	83	1000
MDZ D8270	700	38	Single	83	800
MDZ D8270	600	38	Single	83	700
MDZ D8270	400	38	Single	83	500

Concealed Fix

MDZ C8270	1900	38	Single	83	2000
MDZ C8270	1400	38	Single	83	1500
MDZ C8270	900	38	Single	83	1000
MDZ C8270	700	38	Single	83	800
MDZ C8270	600	38	Single	83	700
MDZ C8270	400	38	Single	83	500

NOTE:
Special sizes available on request



HOW TO SPECIFY

Product No. / Fixing Centres / Tube Diameter / Finish / Fixing (refer diagram below)

eg: B8270 / 900 / 38 / SSS / TM

B = BACK TO BACK FIX

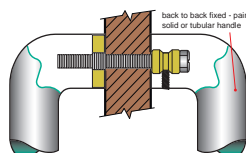

D = DISK FIX

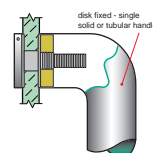

C = CONCEALED FIX

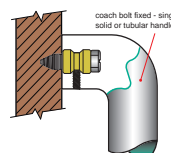

PLEASE SPECIFY DOOR TYPE

GD - Glass doors

TM - Timber doors

AL - Aluminium doors

Entry Door Pull Handle

Material 316 Marine Grade Stainless Steel

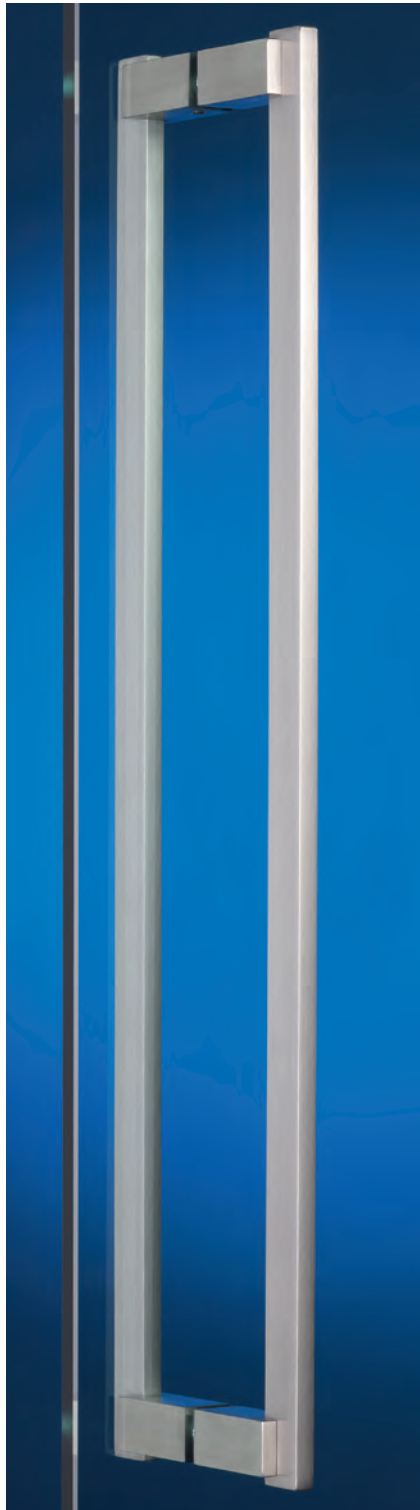

Product No.	Fixing Centres mm	Rectangle Section mm	Unit	Projection mm	Overall Length mm
-------------	-------------------	----------------------	------	---------------	-------------------

Back to Back Fix

MDZ B8280	1000	25x10	Pair	70	1035
MDZ B8280	800	25x10	Pair	70	835
MDZ B8280	600	25x10	Pair	70	635
MDZ B8280	400	25x10	Pair	70	435

Disk Fix

MDZ D8280	1000	25x10	Single	70	1035
MDZ D8280	800	25x10	Single	70	835
MDZ D8280	600	25x10	Single	70	635
MDZ D8280	400	25x10	Single	70	435

Concealed Fix

MDZ C8280	1000	25x10	Single	70	1035
MDZ C8280	800	25x10	Single	70	835
MDZ C8280	600	25x10	Single	70	635
MDZ C8280	400	25x10	Single	70	435

NOTE:
Square legs measure 25mm x 25mm
Special sizes available on request



HOW TO SPECIFY

Product No. / Fixing Centres / Rectangular Section / Finish / Fixing (refer diagram below)

eg: B8280 / 1000 / 25x10 / SSS / TM

B = BACK TO BACK FIX

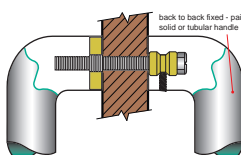

D = DISK FIX

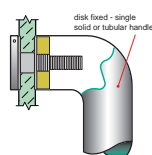

C = CONCEALED FIX

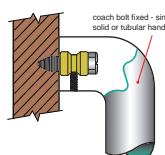

PLEASE SPECIFY DOOR TYPE

GD - Glass doors

TM - Timber doors

AL - Aluminium doors

Entry Door Pull Handle

Material 316 Marine Grade Stainless Steel



Product No.	Fixing Centres mm	Rail Section mm	Standoff mm	Unit	Projection mm	Overall Length mm
-------------	-------------------	-----------------	-------------	------	---------------	-------------------

Back to Back Fix

MDZ B8330	775	50x10	50x25	Pair	50	800
MDZ B8330	575	50x10	50x25	Pair	50	600
MDZ B8330	375	50x10	50x25	Pair	50	400

Disk Fix

MDZ D8330	775	50x10	50x25	Single	50	800
MDZ D8330	575	50x10	50x25	Single	50	600
MDZ D8330	375	50x10	50x25	Single	50	400

Concealed Fix

MDZ C8330	775	50x10	50x25	Single	50	800
MDZ C8330	575	50x10	50x25	Single	50	600
MDZ C8330	375	50x10	50x25	Single	50	400

NOTE:
Special sizes available on request



HOW TO SPECIFY

Product No. / Fixing Centres / Rail Section / Finish / Fixing (refer diagram below)
eg: B8330 / 575 / 50x10 / SSS / TM

B = BACK TO BACK FIX

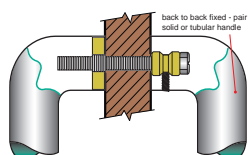

D = DISK FIX

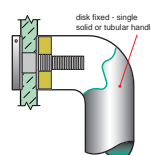

C = CONCEALED FIX

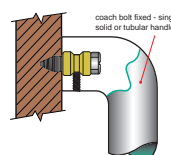

PLEASE SPECIFY DOOR TYPE
GD - Glass doors
TM - Timber doors
AL - Aluminium doors

Entry Door Pull Handle

Material 316 Marine Grade Stainless Steel



Product No.	Diameter mm	Projection mm	Length mm	Fixing Centres mm
MDZ 8340/A	32	77	2400	2240
MDZ 8340/B	32	77	2300	2140
MDZ 8340/C	32	77	2200	2040
MDZ 8340/D	32	77	2100	1940
MDZ 8340/E	32	77	2000	1840
MDZ 8340/F	32	77	1900	1740
MDZ 8340/G	32	77	1800	1640
MDZ 8340/H	32	77	1700	1540
MDZ 8340/I	32	77	1600	1440
MDZ 8340/J	32	77	1500	1340
MDZ 8340/K	32	77	1400	1240
MDZ 8340/L	32	77	1300	1140
MDZ 8340/M	32	77	1200	1040
MDZ 8340/N	32	77	1100	940
MDZ 8340/O	32	77	1000	840
MDZ 8340/P	32	77	900	740
MDZ 8340/Q	32	77	800	640
MDZ 8340/R	32	77	700	540
MDZ 8340/S	32	77	600	440
MDZ 8340/T	32	77	500	340
MDZ 8340/U	32	77	400	240

NOTE:
Special sizes available on request



HOW TO SPECIFY

Product No. / Diameter / Projection / Finish / Fixing (refer diagram below)

eg: B8340A / 32 / 77 / SSS / TM

B = BACK TO BACK FIX

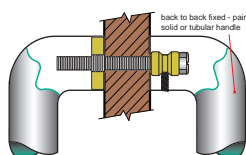

D = DISK FIX

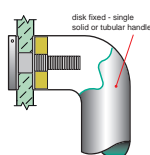

C = CONCEALED FIX

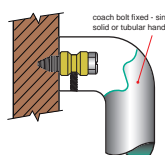

PLEASE SPECIFY DOOR TYPE
GD - Glass doors
TM - Timber doors
AL - Aluminium doors

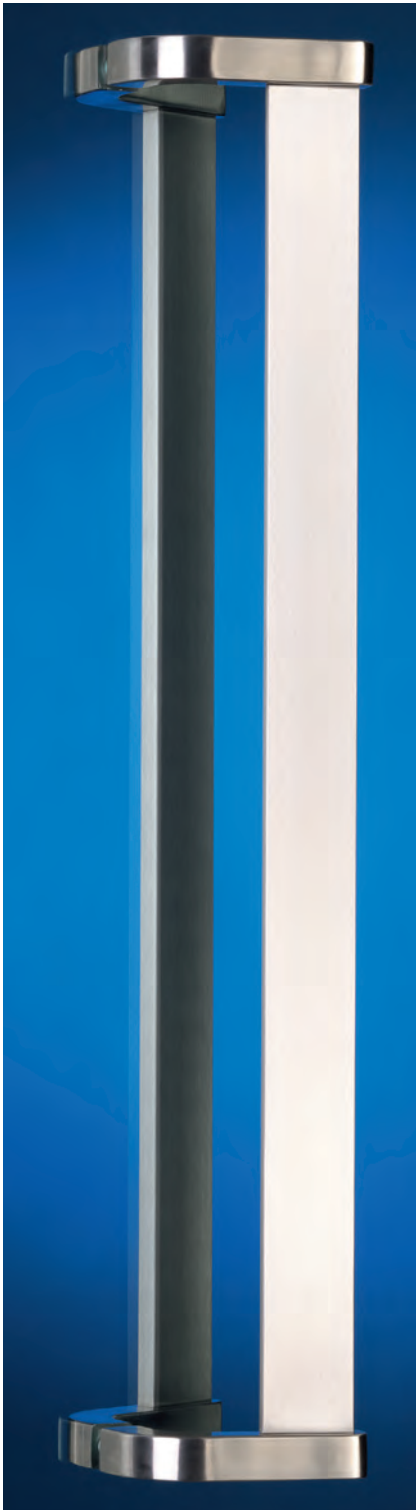

Product No.	Fixing Centres mm	Rail Section mm	Unit	Projection mm	Width mm	Overall Length mm
-------------	-------------------	-----------------	------	---------------	----------	-------------------

Back to Back Fix

MDZ B8350	1500	40x10	Pair	72	95	1519
MDZ B8350	1000	40x10	Pair	72	95	1019
MDZ B8350	800	40x10	Pair	72	95	819
MDZ B8350	600	40x10	Pair	72	95	619
MDZ B8350	400	40x10	Pair	72	95	419
MDZ B8350	200	40x10	Pair	72	95	219

Disk Fix

MDZ D8350	1500	40x10	Single	72	95	1519
MDZ D8350	1000	40x10	Single	72	95	1019
MDZ D8350	800	40x10	Single	72	95	819
MDZ D8350	600	40x10	Single	72	95	619
MDZ D8350	400	40x10	Single	72	95	419
MDZ D8350	200	40x10	Single	72	95	219

Concealed Fix

MDZ C8350	1500	40x10	Single	72	95	1519
MDZ C8350	1000	40x10	Single	72	95	1019
MDZ C8350	800	40x10	Single	72	95	819
MDZ C8350	600	40x10	Single	72	95	619
MDZ C8350	400	40x10	Single	72	95	419
MDZ C8350	200	40x10	Single	72	95	219

HOW TO SPECIFY

Product No. / Fixing Centres / Rail Section / Finish / Fixing (refer diagram below)

eg: B8350 / 800 / 40x10 / SSS / TM

B = BACK TO BACK FIX

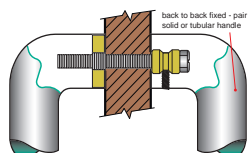

D = DISK FIX

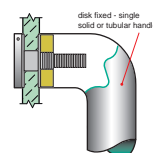

C = CONCEALED FIX

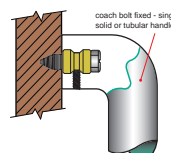

PLEASE SPECIFY DOOR TYPE

GD - Glass doors

TM - Timber doors

AL - Aluminium doors

Entry Door Pull Handle

Material 316 Marine Grade Stainless Steel



Product No.	Section mm	Projection mm	Length mm	Fixing Centres mm
MDZ 8360/E	50x25	70	2250	2000
MDZ 8360/F	50x25	70	1925	1900
MDZ 8360/G	50x25	70	1825	1800
MDZ 8360/H	50x25	70	1725	1700
MDZ 8360/I	50x25	70	1625	1600
MDZ 8360/J	50x25	70	1525	1500
MDZ 8360/K	50x25	70	1425	1400
MDZ 8360/L	50x25	70	1325	1300
MDZ 8360/M	50x25	70	1225	1200
MDZ 8360/N	50x25	70	1125	1100
MDZ 8360/O	50x25	70	1025	1000
MDZ 8360/P	50x25	70	925	900
MDZ 8360/Q	50x25	70	825	800
MDZ 8360/R	50x25	70	725	700
MDZ 8360/S	50x25	70	625	600
MDZ 8360/T	50x25	70	525	500
MDZ 8360/U	50x25	70	425	400

NOTE:
Special sizes available on request



HOW TO SPECIFY

Product No. / Section / Projection / Finish / Fixing (refer diagram below)

eg: 8360E / 50x25 / 70 / SSS / TM

B = BACK TO BACK FIX

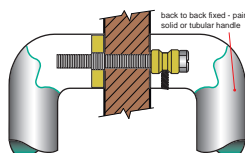

D = DISK FIX

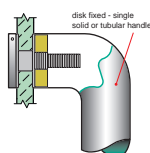

C = CONCEALED FIX

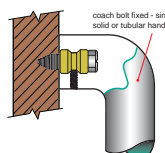

PLEASE SPECIFY DOOR TYPE
GD - Glass doors
TM - Timber doors
AL - Aluminium doors

Entry Door Pull Handle

Material 316 Marine Grade Stainless Steel



Product No.	Fixing Centres mm	Rail Section mm	Unit	Projection mm	Width mm	Overall Length mm
Back to Back Fix						
MDZ B8370	600	25x25	Pair	65	100	625
Disk Fix						
MDZ D8370	600	25x25	Single	65	100	625
Concealed Fix						
MDZ C8370	600	25x25	Single	65	100	625



HOW TO SPECIFY

Product No. / Fixing Centres / Rail Section / Finish / Fixing (refer diagram below)
 eg: B8370 / 600 / 25x25 / SSS / TM

B = BACK TO BACK FIX

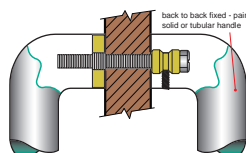

D = DISK FIX

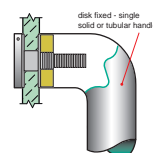

C = CONCEALED FIX

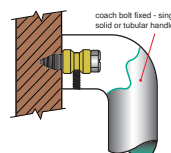

PLEASE SPECIFY DOOR TYPE
 GD - Glass doors
 TM - Timber doors
 AL - Aluminium doors

Entry Door Pull Handle

Material 316 Marine Grade Stainless Steel

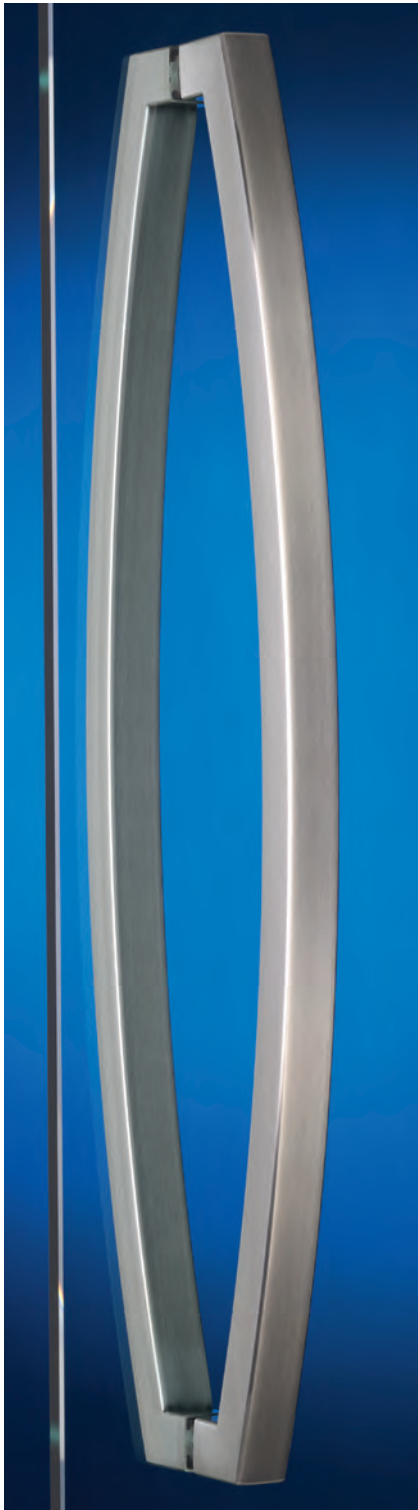

Product No.	Fixing Centres mm	Rail Section mm	Unit	Projection mm	Overall Length mm
Back to Back Fix					
MDZ B8380	600	25x25	Pair	95	625
Disk Fix					
MDZ D8380	600	25x25	Single	95	625
Concealed Fix					
MDZ C8380	600	25x25	Single	95	625

HOW TO SPECIFY

Product No. / Fixing Centres / Rail Section / Finish / Fixing (refer diagram below)

eg: B8380 / 600 / 25x25 / SSS / TM

B = BACK TO BACK FIX

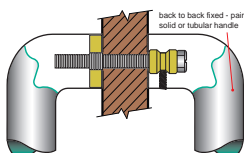

D = DISK FIX

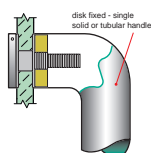

C = CONCEALED FIX

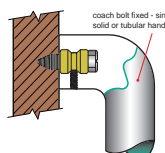

PLEASE SPECIFY DOOR TYPE

GD - Glass doors

TM - Timber doors

AL - Aluminium doors

Entry Door Pull Handle

Material 316 Marine Grade Stainless Steel



Product No.	Fixing Centres mm	Tube Diameter mm	Unit	Projection mm	Width mm	Overall Length mm
-------------	-------------------	------------------	------	---------------	----------	-------------------

Back to Back Fix

MDZ B8390	1500	32	25	Pair	82	75	115	110	1532	1525
MDZ B8390	1000	32	25	Pair	82	75	115	110	1032	1025
MDZ B8390	800	32	25	Pair	82	75	115	110	832	825
MDZ B8390	600	32	25	Pair	82	75	115	110	632	625
MDZ B8390	400	32	25	Pair	82	75	115	110	432	425

Disk Fix

MDZ D8390	1500	32	25	Single	82	75	115	110	1532	1525
MDZ D8390	1000	32	25	Single	82	75	115	110	1032	1025
MDZ D8390	800	32	25	Single	82	75	115	110	832	825
MDZ D8390	600	32	25	Single	82	75	115	110	632	625
MDZ D8390	400	32	25	Single	82	75	115	110	432	425

Concealed Fix

MDZ C8390	1500	32	25	Single	82	75	115	110	1532	1525
MDZ C8390	1000	32	25	Single	82	75	115	110	1032	1025
MDZ C8390	800	32	25	Single	82	75	115	110	832	825
MDZ C8390	600	32	25	Single	82	75	115	110	632	625
MDZ C8390	400	32	25	Single	82	75	115	110	432	425

NOTE:
Special sizes available on request



HOW TO SPECIFY

Product No. / Fixing Centres / Tube Diameter / Finish / Fixing (refer diagram below)

eg: B8390 / 800 / 25 / SSS / TM

B = BACK TO BACK FIX

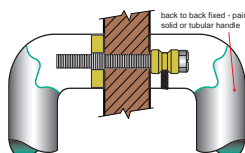

D = DISK FIX

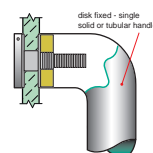

C = CONCEALED FIX

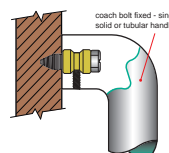

PLEASE SPECIFY DOOR TYPE

GD - Glass doors

TM - Timber doors

AL - Aluminium doors

Entry Door Pull Handle

Material 316 Marine Grade Stainless Steel

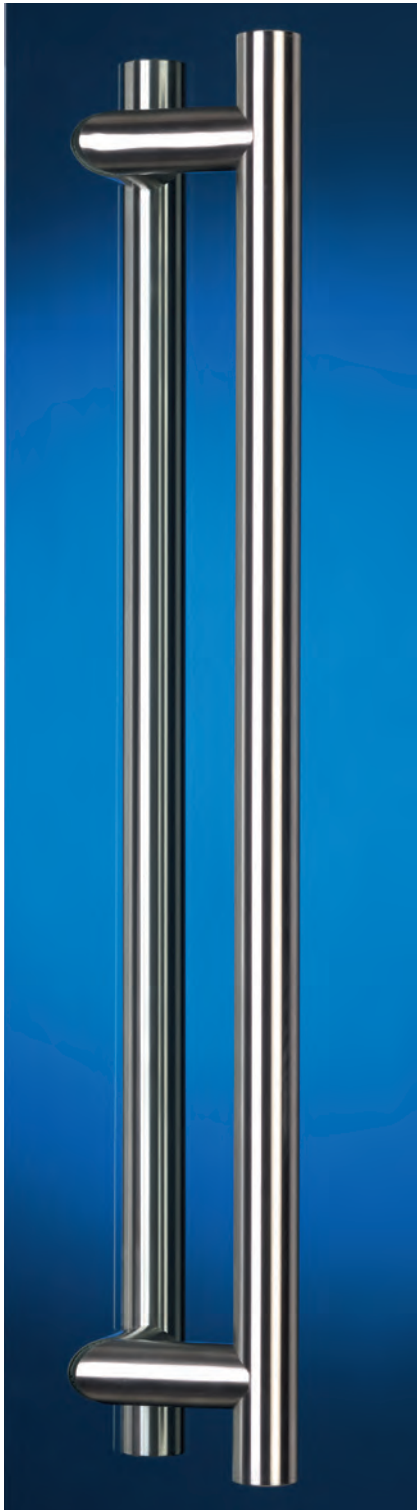

Product No.	Diameter mm		Projection mm		Width mm		Length mm	Fixing Centres mm
MDZ 8400/A	32	25	70	65	100	95	2400	2240
MDZ 8400/B	32	25	70	65	100	95	2300	2140
MDZ 8400/C	32	25	70	65	100	95	2200	2040
MDZ 8400/D	32	25	70	65	100	95	2100	1940
MDZ 8400/E	32	25	70	65	100	95	2000	1840
MDZ 8400/F	32	25	70	65	100	95	1900	1740
MDZ 8400/G	32	25	70	65	100	95	1800	1640
MDZ 8400/H	32	25	70	65	100	95	1700	1540
MDZ 8400/I	32	25	70	65	100	95	1600	1440
MDZ 8400/J	32	25	70	65	100	95	1500	1340
MDZ 8400/K	32	25	70	65	100	95	1400	1240
MDZ 8400/L	32	25	70	65	100	95	1300	1140
MDZ 8400/M	32	25	70	65	100	95	1200	1040
MDZ 8400/N	32	25	70	65	100	95	1100	940
MDZ 8400/O	32	25	70	65	100	95	1000	840
MDZ 8400/P	32	25	70	65	100	95	900	740
MDZ 8400/Q	32	25	70	65	100	95	800	640
MDZ 8400/R	32	25	70	65	100	95	700	540
MDZ 8400/S	32	25	70	65	100	95	600	440
MDZ 8400/T	32	25	70	65	100	95	500	340
MDZ 8400/U	32	25	70	65	100	95	400	240

NOTE:
Special sizes available on request



HOW TO SPECIFY

Product No. / Diameter / Projection / Finish / Fixing (refer diagram below)

eg: 8400A / 32 / 70 / SSS / D Fix GD

B = BACK TO BACK FIX

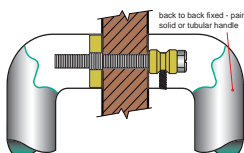

D = DISK FIX

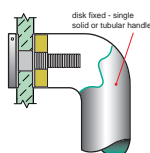

C = CONCEALED FIX

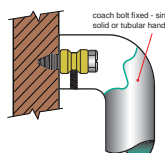

PLEASE SPECIFY DOOR TYPE

GD - Glass doors

TM - Timber doors

AL - Aluminium doors

Entry Door Pull Handle

Material 316 Marine Grade Stainless Steel



Product No.	Fixing Centres mm	Rail Section mm	Standoff mm	Unit	Projection mm	Overall Length mm
-------------	-------------------	-----------------	-------------	------	---------------	-------------------

Back to Back Fix

MDZ B8410	1500	40x10	50x25	Pair	55	1660
MDZ B8410	1000	40x10	50x25	Pair	55	1160
MDZ B8410	800	40x10	50x25	Pair	55	960
MDZ B8410	600	40x10	50x25	Pair	55	760
MDZ B8410	400	40x10	50x25	Pair	55	560

Disk Fix

MDZ D8410	1500	40x10	50x25	Single	55	1660
MDZ D8410	1000	40x10	50x25	Single	55	1160
MDZ D8410	800	40x10	50x25	Single	55	960
MDZ D8410	600	40x10	50x25	Single	55	760
MDZ D8410	400	40x10	50x25	Single	55	560

Concealed Fix

MDZ C8410	1500	40x10	50x25	Single	55	1660
MDZ C8410	1000	40x10	50x25	Single	55	1160
MDZ C8410	800	40x10	50x25	Single	55	960
MDZ C8410	600	40x10	50x25	Single	55	760
MDZ C8410	400	40x10	50x25	Single	55	560

NOTE:
Special sizes available on request



HOW TO SPECIFY

Product No. / Fixing Centres / Rail Section / Finish / Fixing (refer diagram below)
eg: B8410 / 800 / 40x10 / SSS / TM

B = BACK TO BACK FIX

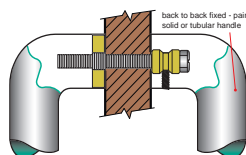

D = DISK FIX

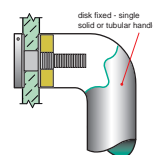

C = CONCEALED FIX

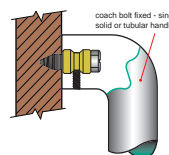

PLEASE SPECIFY DOOR TYPE
GD - Glass doors
TM - Timber doors
AL - Aluminium doors

Entry Door Pull Handle

Material 316 Marine Grade Stainless Steel



Product No.	Fixing Centres mm	Rail Section mm	Unit	Projection mm	Overall Length mm
-------------	-------------------	-----------------	------	---------------	-------------------

Back to Back Fix

MDZ B8420	1500	40x10	Pair	65	1660
MDZ B8420	1000	40x10	Pair	65	1160
MDZ B8420	800	40x10	Pair	65	960
MDZ B8420	600	40x10	Pair	65	760
MDZ B8420	400	40x10	Pair	65	560

Disk Fix

MDZ D8420	1500	40x10	Single	65	1660
MDZ D8420	1000	40x10	Single	65	1160
MDZ D8420	800	40x10	Single	65	960
MDZ D8420	600	40x10	Single	65	760
MDZ D8420	400	40x10	Single	65	560

Concealed Fix

MDZ C8420	1500	40x10	Single	65	1660
MDZ C8420	1000	40x10	Single	65	1160
MDZ C8420	800	40x10	Single	65	960
MDZ C8420	600	40x10	Single	65	760
MDZ C8420	400	40x10	Single	65	560

NOTE:
Special sizes available on request

HOW TO SPECIFY

Product No. / Fixing Centres / Rail Section / Finish / Fixing (refer diagram below)

eg: B8420 / 800 / 40x10 / SSS / TM

B = BACK TO BACK FIX

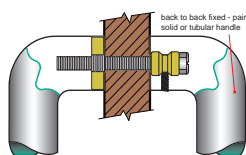

D = DISK FIX

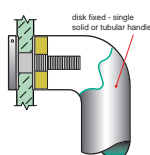

C = CONCEALED FIX

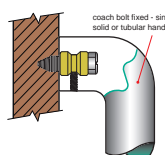

PLEASE SPECIFY DOOR TYPE

GD - Glass doors

TM - Timber doors

AL - Aluminium doors

Entry Door Pull Handle

Material 316 Marine Grade Stainless Steel

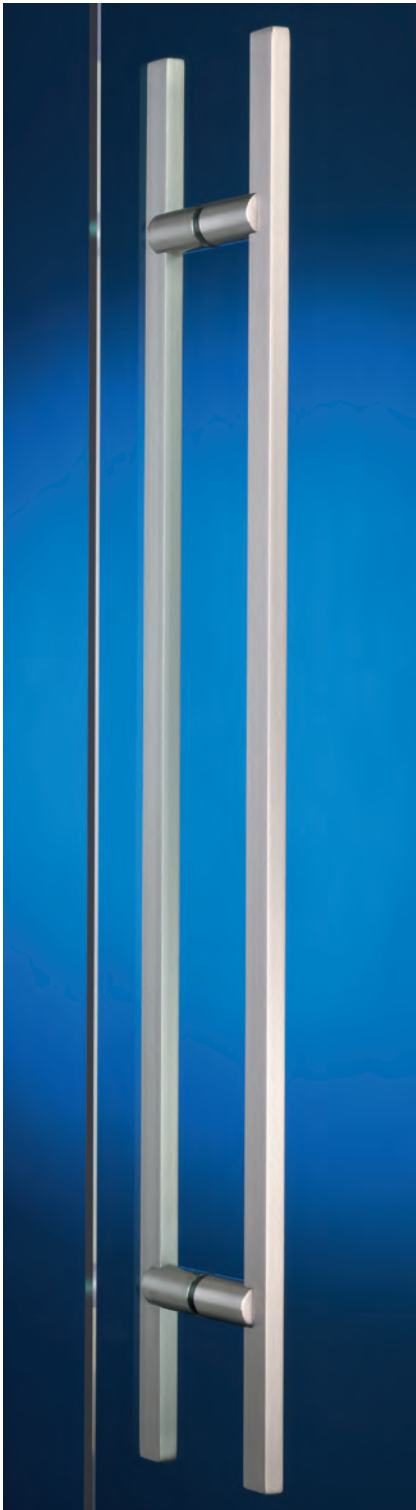

Product No.	Fixing Centres mm	Rail Section mm	Unit	Projection mm	Overall Length mm
-------------	-------------------	-----------------	------	---------------	-------------------

Back to Back Fix

MDZ B8430	1500	25x12	Pair	70	1660
MDZ B8430	1000	25x12	Pair	70	1160
MDZ B8430	800	25x12	Pair	70	960
MDZ B8430	600	25x12	Pair	70	760
MDZ B8430	400	25x12	Pair	70	560

Disk Fix

MDZ D8430	1500	25x12	Single	70	1660
MDZ D8430	1000	25x12	Single	70	1160
MDZ D8430	800	25x12	Single	70	960
MDZ D8430	600	25x12	Single	70	760
MDZ D8430	400	25x12	Single	70	560

Concealed Fix

MDZ C8430	1500	25x12	Single	70	1660
MDZ C8430	1000	25x12	Single	70	1160
MDZ C8430	800	25x12	Single	70	960
MDZ C8430	600	25x12	Single	70	760
MDZ C8430	400	25x12	Single	70	560

NOTE:
Special sizes available on request



HOW TO SPECIFY

Product No. / Fixing Centres / Rail Section / Finish / Fixing (refer diagram below)
eg: B8430 / 800 / 25x12 / SSS / TM

B = BACK TO BACK FIX

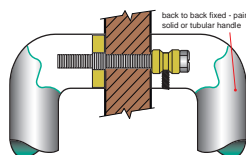

D = DISK FIX

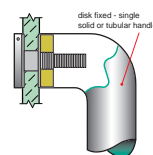

C = CONCEALED FIX

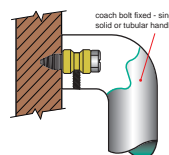

PLEASE SPECIFY DOOR TYPE
GD - Glass doors
TM - Timber doors
AL - Aluminium doors

Entry Door Pull Handle

Material 316 Marine Grade Stainless Steel
Insert Melunak (Plantation Grown Hardwood)



Product No.	Fixing Centres mm	Rail Section mm	Unit	Projection mm	Overall Length mm
-------------	-------------------	-----------------	------	---------------	-------------------

Back to Back Fix

MDZ B8440	1500	50x25	Pair	75	1525
MDZ B8440	1000	50x25	Pair	75	1025
MDZ B8440	800	50x25	Pair	75	825
MDZ B8440	600	50x25	Pair	75	625
MDZ B8440	400	50x25	Pair	75	425

Disk Fix

MDZ D8440	1500	50x25	Single	75	1525
MDZ D8440	1000	50x25	Single	75	1025
MDZ D8440	800	50x25	Single	75	825
MDZ D8440	600	50x25	Single	75	625
MDZ D8440	400	50x25	Single	75	425

Concealed Fix

MDZ C8440	1500	50x25	Single	75	1525
MDZ C8440	1000	50x25	Single	75	1025
MDZ C8440	800	50x25	Single	75	825
MDZ C8440	600	50x25	Single	75	625
MDZ C8440	400	50x25	Single	75	425

NOTE:
Other timbers available on request



HOW TO SPECIFY

Product No. / Fixing Centres / Rail Section / Finish / Fixing (refer diagram below)

eg: B8440 / 800 / 50x25 / SSS / TM

B = BACK TO BACK FIX

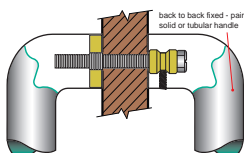

D = DISK FIX

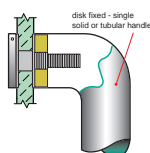

C = CONCEALED FIX

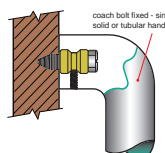

PLEASE SPECIFY DOOR TYPE

GD - Glass doors

TM - Timber doors

AL - Aluminium doors

Entry Door Pull Handle

Material 316 Marine Grade Stainless Steel
Insert Melunak (Plantation Grown Hardwood)



Product No.	Fixing Centres mm	Rail Section mm	Unit	Projection mm	Overall Length mm
-------------	-------------------	-----------------	------	---------------	-------------------

Back to Back Fix

MDZ B8445	1500	50x25	Pair	75	1525
MDZ B8445	1000	50x25	Pair	75	1025
MDZ B8445	800	50x25	Pair	75	825
MDZ B8445	600	50x25	Pair	75	625
MDZ B8445	400	50x25	Pair	75	425

Disk Fix

MDZ D8445	1500	50x25	Single	75	1525
MDZ D8445	1000	50x25	Single	75	1025
MDZ D8445	800	50x25	Single	75	825
MDZ D8445	600	50x25	Single	75	625
MDZ D8445	400	50x25	Single	75	425

Concealed Fix

MDZ C8445	1500	50x25	Single	75	1525
MDZ C8445	1000	50x25	Single	75	1025
MDZ C8445	800	50x25	Single	75	825
MDZ C8445	600	50x25	Single	75	625
MDZ C8445	400	50x25	Single	75	425

NOTE:
Other timbers available on request



HOW TO SPECIFY

Product No. / Fixing Centres / Rail Section / Finish / Fixing (refer diagram below)
eg: B8445 / 800 / 50x25 / SSS / TM

B = BACK TO BACK FIX

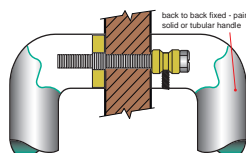

D = DISK FIX

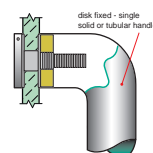

C = CONCEALED FIX

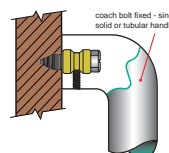

PLEASE SPECIFY DOOR TYPE
GD - Glass doors
TM - Timber doors
AL - Aluminium doors

Entry Door Pull Handle

Material 316 Marine Grade Stainless Steel
Insert Melunak (Plantation Grown Hardwood)



Product No.	Fixing Centres mm	Rail Section mm	Standoff mm	Unit	Projection mm	Overall Length mm
-------------	-------------------	-----------------	-------------	------	---------------	-------------------

Back to Back Fix

MDZ B8450	1340	32x32	25x25	Pair	70	1500
MDZ B8450	840	32x32	25x25	Pair	70	1000
MDZ B8450	640	32x32	25x25	Pair	70	800
MDZ B8450	440	32x32	25x25	Pair	70	600
MDZ B8450	240	32x32	25x25	Pair	70	400

Disk Fix

MDZ D8450	1340	32x32	25x25	Single	70	1500
MDZ D8450	840	32x32	25x25	Single	70	1000
MDZ D8450	640	32x32	25x25	Single	70	800
MDZ D8450	440	32x32	25x25	Single	70	600
MDZ D8450	240	32x32	25x25	Single	70	400

Concealed Fix

MDZ C8450	1340	32x32	25x25	Single	70	1500
MDZ C8450	840	32x32	25x25	Single	70	1000
MDZ C8450	640	32x32	25x25	Single	70	800
MDZ C8450	440	32x32	25x25	Single	70	600
MDZ C8450	240	32x32	25x25	Single	70	400

NOTE:
Other timbers available on request



HOW TO SPECIFY

Product No. / Fixing Centres / Rail Section / Finish / Fixing (refer diagram below)

eg: B8450 / 840 / 32x32 / SSS / TM

B = BACK TO BACK FIX

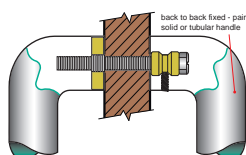

D = DISK FIX

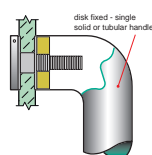

C = CONCEALED FIX

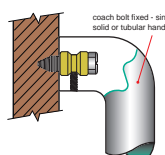

PLEASE SPECIFY DOOR TYPE
GD - Glass doors
TM - Timber doors
AL - Aluminium doors

Entry Door Pull Handle

Material 316 Marine Grade Stainless Steel
Insert Melunak (Plantation Grown Hardwood)



Product No.	Fixing Centres mm	Rail Section mm	Standoff mm	Unit	Projection mm	Overall Length mm
-------------	-------------------	-----------------	-------------	------	---------------	-------------------

Back to Back Fix

MDZ B8455	1340	32x32	25x25	Pair	70	1500
MDZ B8455	840	32x32	25x25	Pair	70	1000
MDZ B8455	640	32x32	25x25	Pair	70	800
MDZ B8455	440	32x32	25x25	Pair	70	600
MDZ B8455	240	32x32	25x25	Pair	70	400

Disk Fix

MDZ D8455	1340	32x32	25x25	Single	70	1500
MDZ D8455	840	32x32	25x25	Single	70	1000
MDZ D8455	640	32x32	25x25	Single	70	800
MDZ D8455	440	32x32	25x25	Single	70	600
MDZ D8455	240	32x32	25x25	Single	70	400

Concealed Fix

MDZ C8455	1340	32x32	25x25	Single	70	1500
MDZ C8455	840	32x32	25x25	Single	70	1000
MDZ C8455	640	32x32	25x25	Single	70	800
MDZ C8455	440	32x32	25x25	Single	70	600
MDZ C8455	240	32x32	25x25	Single	70	400

NOTE:
Other timbers available on request



HOW TO SPECIFY

Product No. / Fixing Centres / Rail Section / Finish / Fixing (refer diagram below)
eg: B8455 / 840 / 32x32 / SSS / TM

B = BACK TO BACK FIX

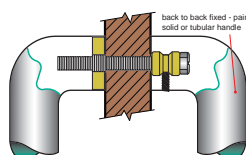

D = DISK FIX

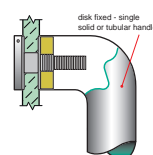

C = CONCEALED FIX

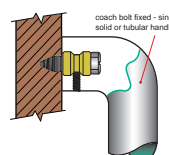

PLEASE SPECIFY DOOR TYPE
GD - Glass doors
TM - Timber doors
AL - Aluminium doors

Entry Door Pull Handle

Material 316 Marine Grade Stainless Steel
Insert Melunak (Plantation Grown Hardwood)



Product No.	Fixing Centres mm	Rail Section mm	Unit	Projection mm	Overall Length mm
-------------	-------------------	-----------------	------	---------------	-------------------

Back to Back Fix

MDZ B8460	1000	40x10	Pair	65	1160
MDZ B8460	800	40x10	Pair	65	960
MDZ B8460	600	40x10	Pair	65	760
MDZ B8460	400	40x10	Pair	65	560

Disk Fix

MDZ D8460	1000	40x10	Single	65	1160
MDZ D8460	800	40x10	Single	65	960
MDZ D8460	600	40x10	Single	65	760
MDZ D8460	400	40x10	Single	65	560

Concealed Fix

MDZ C8460	1000	40x10	Single	65	1160
MDZ C8460	800	40x10	Single	65	960
MDZ C8460	600	40x10	Single	65	760
MDZ C8460	400	40x10	Single	65	560

NOTE:
Other timbers available on request

HOW TO SPECIFY

Product No. / Fixing Centres / Rail Section / Finish / Fixing (refer diagram below)

eg: B8460 / 800 / 40x10 / SSS / TM

B = BACK TO BACK FIX

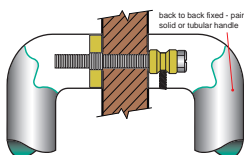

D = DISK FIX

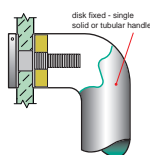

C = CONCEALED FIX

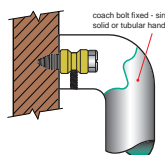

PLEASE SPECIFY DOOR TYPE

GD - Glass doors

TM - Timber doors

AL - Aluminium doors

Entry Door Pull Handle

Material 316 Marine Grade Stainless Steel
Insert Melunak (Plantation Grown Hardwood)



Product No.	Fixing Centres mm	Rail Section mm	Unit	Projection mm	Overall Length mm
-------------	-------------------	-----------------	------	---------------	-------------------

Back to Back Fix

MDZ B8465	1000	40x10	Pair	65	1160
MDZ B8465	800	40x10	Pair	65	960
MDZ B8465	600	40x10	Pair	65	760
MDZ B8465	400	40x10	Pair	65	560

Disk Fix

MDZ D8465	1000	40x10	Single	65	1160
MDZ D8465	800	40x10	Single	65	960
MDZ D8465	600	40x10	Single	65	760
MDZ D8465	400	40x10	Single	65	560

Concealed Fix

MDZ C8465	1000	40x10	Single	65	1160
MDZ C8465	800	40x10	Single	65	960
MDZ C8465	600	40x10	Single	65	760
MDZ C8465	400	40x10	Single	65	560

NOTE:
Other timbers available on request

HOW TO SPECIFY

Product No. / Fixing Centres / Rail Section / Finish / Fixing (refer diagram below)
eg: B8465 / 800 / 40x10 / SSS / TM

B = BACK TO BACK FIX

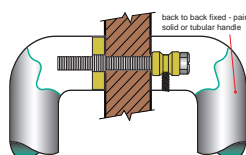

D = DISK FIX

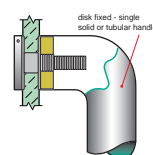

C = CONCEALED FIX

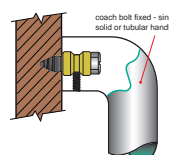

PLEASE SPECIFY DOOR TYPE
GD - Glass doors
TM - Timber doors
AL - Aluminium doors

Entry Door Pull Handle

Material 316 Marine Grade Stainless Steel
Insert Melunak (Plantation Grown Hardwood)



Product No.	Diameter mm	Projection mm	Length mm	Fixing Centres mm
MDZ 8470/A	32	76	2400	2240
MDZ 8470/B	32	76	2300	2140
MDZ 8470/C	32	76	2200	2040
MDZ 8470/D	32	76	2100	1940
MDZ 8470/E	32	76	2000	1840
MDZ 8470/F	32	76	1900	1740
MDZ 8470/G	32	76	1800	1640
MDZ 8470/H	32	76	1700	1540
MDZ 8470/I	32	76	1600	1440
MDZ 8470/J	32	76	1500	1340
MDZ 8470/K	32	76	1400	1240
MDZ 8470/L	32	76	1300	1140
MDZ 8470/M	32	76	1200	1040
MDZ 8470/N	32	76	1100	940
MDZ 8470/O	32	76	1000	840
MDZ 8470/P	32	76	900	740
MDZ 8470/Q	32	76	800	640
MDZ 8470/R	32	76	700	540
MDZ 8470/S	32	76	600	440
MDZ 8470/T	32	76	500	340
MDZ 8470/U	32	76	400	240

NOTE:
 MDZ 8470/A to E to come with 3 stand offs (fixing points)
 Special sizes available on request
 Other timbers available on request



HOW TO SPECIFY

Product No. / Diameter / Projection / Finish / Fixing (refer diagram below)

eg: 8470A / 32 / 76 / SSS / TM

B = BACK TO BACK FIX

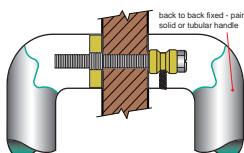

D = DISK FIX

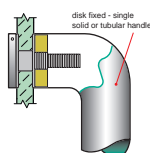

C = CONCEALED FIX

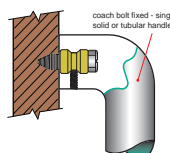

PLEASE SPECIFY DOOR TYPE
 GD - Glass doors
 TM - Timber doors
 AL - Aluminium doors

Entry Door Pull Handle

Material 316 Marine Grade Stainless Steel
Insert Melunak (Plantation Grown Hardwood)

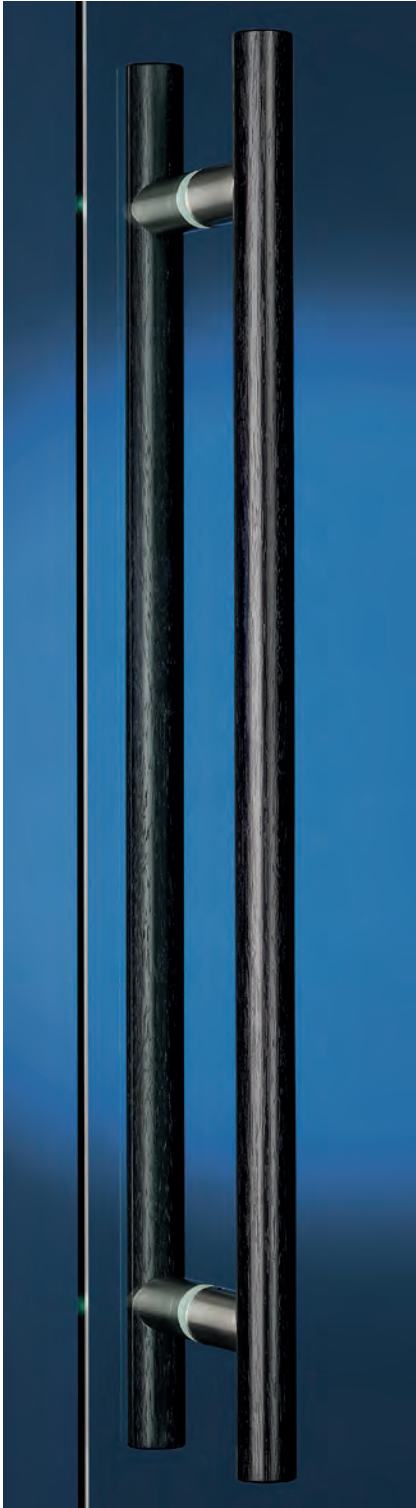

Product No.	Diameter mm	Projection mm	Length mm	Fixing Centres mm
MDZ 8475/A	32	76	2400	2240
MDZ 8475/B	32	76	2300	2140
MDZ 8475/C	32	76	2200	2040
MDZ 8475/D	32	76	2100	1940
MDZ 8475/E	32	76	2000	1840
MDZ 8475/F	32	76	1900	1740
MDZ 8475/G	32	76	1800	1640
MDZ 8475/H	32	76	1700	1540
MDZ 8475/I	32	76	1600	1440
MDZ 8475/J	32	76	1500	1340
MDZ 8475/K	32	76	1400	1240
MDZ 8475/L	32	76	1300	1140
MDZ 8475/M	32	76	1200	1040
MDZ 8475/N	32	76	1100	940
MDZ 8475/O	32	76	1000	840
MDZ 8475/P	32	76	900	740
MDZ 8475/Q	32	76	800	640
MDZ 8475/R	32	76	700	540
MDZ 8475/S	32	76	600	440
MDZ 8475/T	32	76	500	340
MDZ 8475/U	32	76	400	240

NOTE:

MDZ 8475/A to E to come with 3 stand offs (fixing points)

Special sizes available on request

Other timbers available on request



HOW TO SPECIFY

Product No. / Diameter / Projection / Finish / Fixing (refer diagram below)

eg: 8475A / 32 / 76 / SSS / TM

B = BACK TO BACK FIX

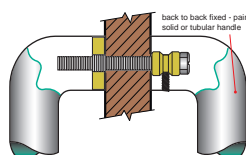

D = DISK FIX

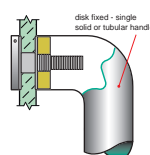

C = CONCEALED FIX

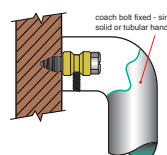

PLEASE SPECIFY DOOR TYPE

GD - Glass doors

TM - Timber doors

AL - Aluminium doors

Entry Door Pull Handle

Material 316 Marine Grade Stainless Steel
Insert Melunak (Plantation Grown Hardwood)

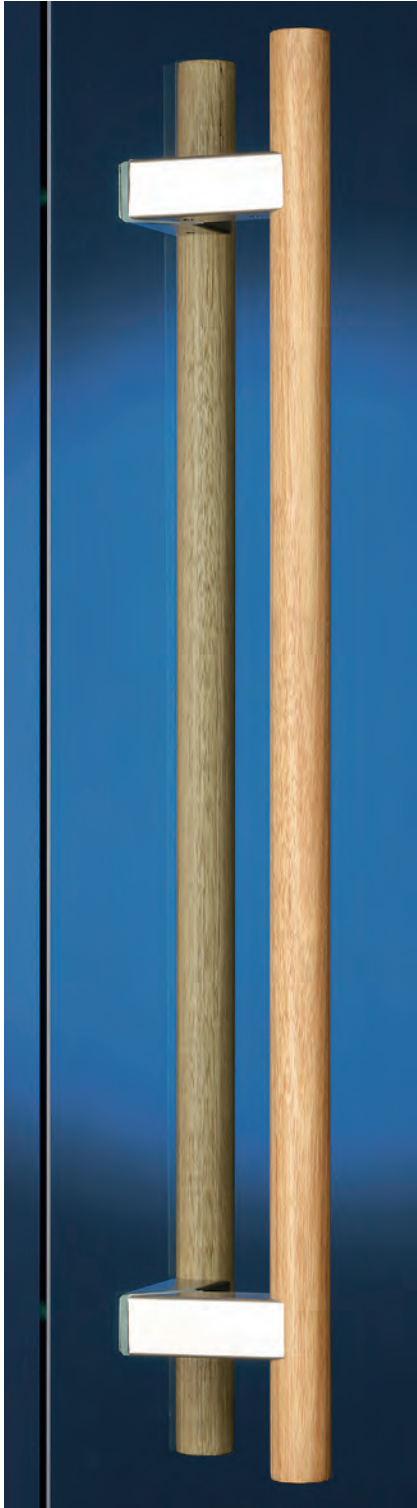

Product No.	Diameter mm	Projection mm	Length mm	Fixing Centres mm
MDZ 8480/A	32	75	2400	2240
MDZ 8480/B	32	75	2300	2140
MDZ 8480/C	32	75	2200	2040
MDZ 8480/D	32	75	2100	1940
MDZ 8480/E	32	75	2000	1840
MDZ 8480/F	32	75	1900	1740
MDZ 8480/G	32	75	1800	1640
MDZ 8480/H	32	75	1700	1540
MDZ 8480/I	32	75	1600	1440
MDZ 8480/J	32	75	1500	1340
MDZ 8480/K	32	75	1400	1240
MDZ 8480/L	32	75	1300	1140
MDZ 8480/M	32	75	1200	1040
MDZ 8480/N	32	75	1100	940
MDZ 8480/O	32	75	1000	840
MDZ 8480/P	32	75	900	740
MDZ 8480/Q	32	75	800	640
MDZ 8480/R	32	75	700	540
MDZ 8480/S	32	75	600	440
MDZ 8480/T	32	75	500	340
MDZ 8480/U	32	75	400	240

NOTE:
 MDZ 8480/A to E to come with 3 stand offs (fixing points)
 Special sizes available on request
 Other timbers available on request



HOW TO SPECIFY

Product No. / Diameter / Projection / Finish / Fixing (refer diagram below)

eg: 8480A / 32 / 75 / SSS / TM

B = BACK TO BACK FIX

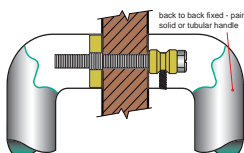

D = DISK FIX

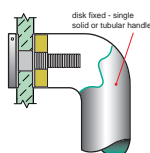

C = CONCEALED FIX

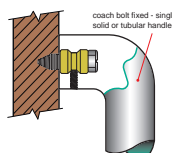

PLEASE SPECIFY DOOR TYPE
 GD - Glass doors
 TM - Timber doors
 AL - Aluminium doors

Entry Door Pull Handle

Material 316 Marine Grade Stainless Steel
Insert Melunak (Plantation Grown Hardwood)



Product No.	Diameter mm	Projection mm	Length mm	Fixing Centres mm
MDZ 8485/A	32	75	2400	2240
MDZ 8485/B	32	75	2300	2140
MDZ 8485/C	32	75	2200	2040
MDZ 8485/D	32	75	2100	1940
MDZ 8485/E	32	75	2000	1840
MDZ 8485/F	32	75	1900	1740
MDZ 8485/G	32	75	1800	1640
MDZ 8485/H	32	75	1700	1540
MDZ 8485/I	32	75	1600	1440
MDZ 8485/J	32	75	1500	1340
MDZ 8485/K	32	75	1400	1240
MDZ 8485/L	32	75	1300	1140
MDZ 8485/M	32	75	1200	1040
MDZ 8485/N	32	75	1100	940
MDZ 8485/O	32	75	1000	840
MDZ 8485/P	32	75	900	740
MDZ 8485/Q	32	75	800	640
MDZ 8485/R	32	75	700	540
MDZ 8485/S	32	75	600	440
MDZ 8485/T	32	75	500	340
MDZ 8485/U	32	75	400	240

NOTE:

MDZ 8485/A to E to come with 3 stand offs (fixing points)

Special sizes available on request

Other timbers available on request



HOW TO SPECIFY

Product No. / Diameter / Projection / Finish / Fixing (refer diagram below)

eg: 8485A / 32 / 75 / SSS / TM

B = BACK TO BACK FIX

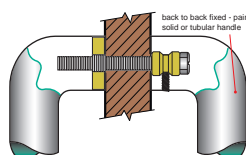

D = DISK FIX

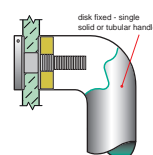

C = CONCEALED FIX

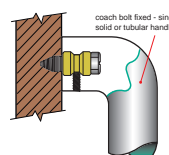

PLEASE SPECIFY DOOR TYPE

GD - Glass doors

TM - Timber doors

AL - Aluminium doors

Entry Door Pull Handle

Material 316 Marine Grade Stainless Steel
Insert Melunak (Plantation Grown Hardwood)

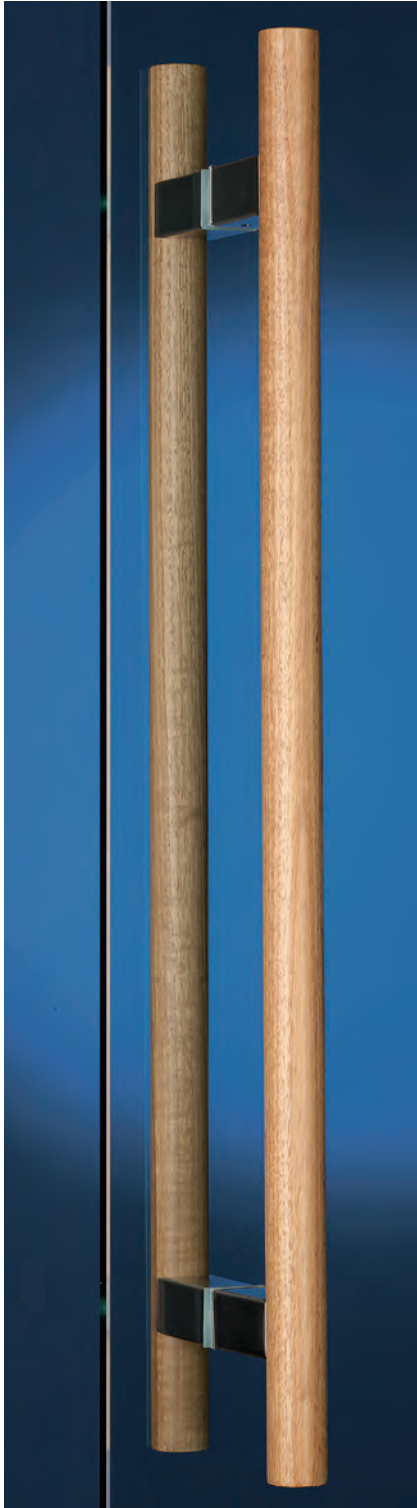

Product No.	Diameter mm	Projection mm	Length mm	Fixing Centres mm
MDZ 8490/A	32	77	2400	2240
MDZ 8490/B	32	77	2300	2140
MDZ 8490/C	32	77	2200	2040
MDZ 8490/D	32	77	2100	1940
MDZ 8490/E	32	77	2000	1840
MDZ 8490/F	32	77	1900	1740
MDZ 8490/G	32	77	1800	1640
MDZ 8490/H	32	77	1700	1540
MDZ 8490/I	32	77	1600	1440
MDZ 8490/J	32	77	1500	1340
MDZ 8490/K	32	77	1400	1240
MDZ 8490/L	32	77	1300	1140
MDZ 8490/M	32	77	1200	1040
MDZ 8490/N	32	77	1100	940
MDZ 8490/O	32	77	1000	840
MDZ 8490/P	32	77	900	740
MDZ 8490/Q	32	77	800	640
MDZ 8490/R	32	77	700	540
MDZ 8490/S	32	77	600	440
MDZ 8490/T	32	77	500	340
MDZ 8490/U	32	77	400	240

NOTE:

MDZ 8490/A to E to come with 3 stand offs (fixing points)

Special sizes available on request

Other timbers available on request



HOW TO SPECIFY

Product No. / Diameter / Projection / Finish / Fixing (refer diagram below)

eg: 8490A / 32 / 77 / SSS / TM

B = BACK TO BACK FIX

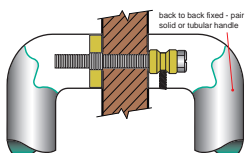

D = DISK FIX

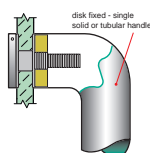

C = CONCEALED FIX

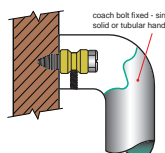

PLEASE SPECIFY DOOR TYPE

GD - Glass doors

TM - Timber doors

AL - Aluminium doors

Entry Door Pull Handle

Material 316 Marine Grade Stainless Steel
Insert Melunak (Plantation Grown Hardwood)



Product No.	Diameter mm	Projection mm	Length mm	Fixing Centres mm
MDZ 8495/A	32	77	2400	2240
MDZ 8495/B	32	77	2300	2140
MDZ 8495/C	32	77	2200	2040
MDZ 8495/D	32	77	2100	1940
MDZ 8495/E	32	77	2000	1840
MDZ 8495/F	32	77	1900	1740
MDZ 8495/G	32	77	1800	1640
MDZ 8495/H	32	77	1700	1540
MDZ 8495/I	32	77	1600	1440
MDZ 8495/J	32	77	1500	1340
MDZ 8495/K	32	77	1400	1240
MDZ 8495/L	32	77	1300	1140
MDZ 8495/M	32	77	1200	1040
MDZ 8495/N	32	77	1100	940
MDZ 8495/O	32	77	1000	840
MDZ 8495/P	32	77	900	740
MDZ 8495/Q	32	77	800	640
MDZ 8495/R	32	77	700	540
MDZ 8495/S	32	77	600	440
MDZ 8495/T	32	77	500	340
MDZ 8495/U	32	77	400	240

NOTE:

MDZ 8495/A to E to come with 3 stand offs (fixing points)

Special sizes available on request

Other timbers available on request



HOW TO SPECIFY

Product No. / Diameter / Projection / Finish / Fixing (refer diagram below)

eg: 8495A / 32 / 77 / SSS / TM

B = BACK TO BACK FIX

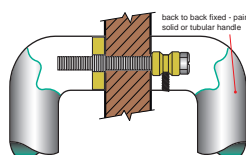

D = DISK FIX

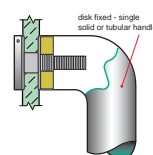

C = CONCEALED FIX

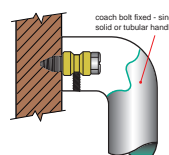

PLEASE SPECIFY DOOR TYPE

GD - Glass doors

TM - Timber doors

AL - Aluminium doors

Entry Door Pull Handle

Material 316 Marine Grade Stainless Steel
Insert Melunak (Plantation Grown Hardwood)



Product No.	Fixing Centres mm	Rail Section mm	Unit	Projection mm	Overall Length mm
-------------	-------------------	-----------------	------	---------------	-------------------

Back to Back Fix

MDZ B8500	1500	50x25	Pair	70	1550
MDZ B8500	1000	50x25	Pair	70	1050
MDZ B8500	800	50x25	Pair	70	850
MDZ B8500	600	50x25	Pair	70	650
MDZ B8500	400	50x25	Pair	70	450

Disk Fix

MDZ D8500	1500	50x25	Single	70	1550
MDZ D8500	1000	50x25	Single	70	1050
MDZ D8500	800	50x25	Single	70	850
MDZ D8500	600	50x25	Single	70	650
MDZ D8500	400	50x25	Single	70	450

Concealed Fix

MDZ C8500	1500	50x25	Single	70	1550
MDZ C8500	1000	50x25	Single	70	1050
MDZ C8500	800	50x25	Single	70	850
MDZ C8500	600	50x25	Single	70	650
MDZ C8500	400	50x25	Single	70	450

NOTE:
Special sizes available on request
Other timbers available on request



HOW TO SPECIFY

Product No. / Fixing Centres / Rail Section / Finish / Fixing (refer diagram below)

eg: B8500 / 800 / 50x25 / SSS / TM

B = BACK TO BACK FIX

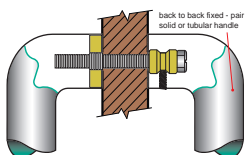

D = DISK FIX

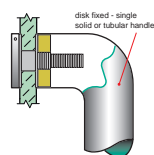

C = CONCEALED FIX

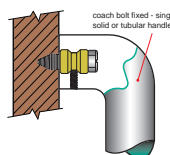

PLEASE SPECIFY DOOR TYPE

GD - Glass doors

TM - Timber doors

AL - Aluminium doors

Entry Door Pull Handle

Material 316 Marine Grade Stainless Steel
Insert Melunak (Plantation Grown Hardwood)



Product No.	Fixing Centres mm	Rail Section mm	Unit	Projection mm	Overall Length mm
-------------	-------------------	-----------------	------	---------------	-------------------

Back to Back Fix

MDZ B8505	1500	50x25	Pair	70	1550
MDZ B8505	1000	50x25	Pair	70	1050
MDZ B8505	800	50x25	Pair	70	850
MDZ B8505	600	50x25	Pair	70	650
MDZ B8505	400	50x25	Pair	70	450

Disk Fix

MDZ D8505	1500	50x25	Single	70	1550
MDZ D8505	1000	50x25	Single	70	1050
MDZ D8505	800	50x25	Single	70	850
MDZ D8505	600	50x25	Single	70	650
MDZ D8505	400	50x25	Single	70	450

Concealed Fix

MDZ C8505	1500	50x25	Single	70	1550
MDZ C8505	1000	50x25	Single	70	1050
MDZ C8505	800	50x25	Single	70	850
MDZ C8505	600	50x25	Single	70	650
MDZ C8505	400	50x25	Single	70	450

NOTE:
Special sizes available on request
Other timbers available on request



HOW TO SPECIFY

Product No. / Fixing Centres / Rail Section / Finish / Fixing (refer diagram below)
eg: B8505 / 800 / 50x25 / SSS / TM

B = BACK TO BACK FIX

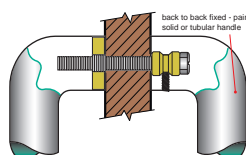

D = DISK FIX

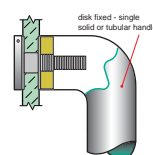

C = CONCEALED FIX

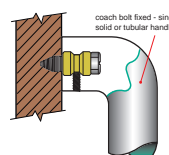

PLEASE SPECIFY DOOR TYPE
GD - Glass doors
TM - Timber doors
AL - Aluminium doors

Entry Door Pull Handle

Material 316 Marine Grade Stainless Steel
Insert Melunak (Plantation Grown Hardwood)



Product No.	Fixing Centres mm	Rail Section mm	Unit	Projection mm	Overall Length mm
-------------	-------------------	-----------------	------	---------------	-------------------

Back to Back Fix

MDZ B8510	1500	32x32	Pair	77	1660
MDZ B8510	1000	32x32	Pair	77	1160
MDZ B8510	800	32x32	Pair	77	960
MDZ B8510	600	32x32	Pair	77	760
MDZ B8510	400	32x32	Pair	77	560

Disk Fix

MDZ D8510	1500	32x32	Single	77	1660
MDZ D8510	1000	32x32	Single	77	1160
MDZ D8510	800	32x32	Single	77	960
MDZ D8510	600	32x32	Single	77	760
MDZ D8510	400	32x32	Single	77	560

Concealed Fix

MDZ C8510	1500	32x32	Single	77	1660
MDZ C8510	1000	32x32	Single	77	1160
MDZ C8510	800	32x32	Single	77	960
MDZ C8510	600	32x32	Single	77	760
MDZ C8510	400	32x32	Single	77	560

NOTE:
Special sizes available on request
Other timbers available on request



HOW TO SPECIFY

Product No. / Fixing Centres / Rail Section / Finish / Fixing (refer diagram below)
eg: B8510 / 1500 / 32x32 / SSS / TM

B = BACK TO BACK FIX

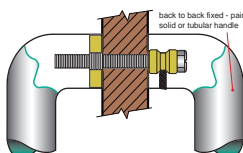

D = DISK FIX

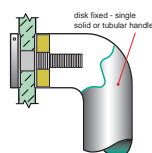

C = CONCEALED FIX

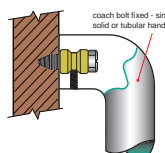

PLEASE SPECIFY DOOR TYPE
GD - Glass doors
TM - Timber doors
AL - Aluminium doors

Entry Door Pull Handle

Material 316 Marine Grade Stainless Steel
Insert Melunak (Plantation Grown Hardwood)



Product No.	Fixing Centres mm	Rail Section mm	Unit	Projection mm	Overall Length mm
-------------	-------------------	-----------------	------	---------------	-------------------

Back to Back Fix

MDZ B8515	1500	32x32	Pair	77	1660
MDZ B8515	1000	32x32	Pair	77	1160
MDZ B8515	800	32x32	Pair	77	960
MDZ B8515	600	32x32	Pair	77	760
MDZ B8515	400	32x32	Pair	77	560

Disk Fix

MDZ D8515	1500	32x32	Single	77	1660
MDZ D8515	1000	32x32	Single	77	1160
MDZ D8515	800	32x32	Single	77	960
MDZ D8515	600	32x32	Single	77	760
MDZ D8515	400	32x32	Single	77	560

Concealed Fix

MDZ C8515	1500	32x32	Single	77	1660
MDZ C8515	1000	32x32	Single	77	1160
MDZ C8515	800	32x32	Single	77	960
MDZ C8515	600	32x32	Single	77	760
MDZ C8515	400	32x32	Single	77	560

NOTE:
Special sizes available on request
Other timbers available on request



HOW TO SPECIFY

Product No. / Fixing Centres / Rail Section / Finish / Fixing (refer diagram below)
eg: B8515 / 1500 / 32x32 / SSS / TM

B = BACK TO BACK FIX

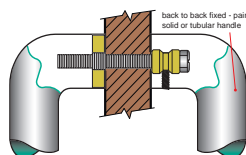

D = DISK FIX

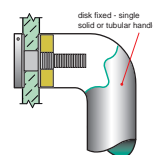

C = CONCEALED FIX

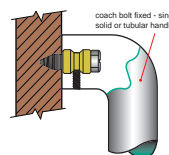

PLEASE SPECIFY DOOR TYPE
GD - Glass doors
TM - Timber doors
AL - Aluminium doors

Entry Door Pull Handle

Material 316 Marine Grade Stainless Steel
Insert Melunak (Plantation Grown Hardwood)

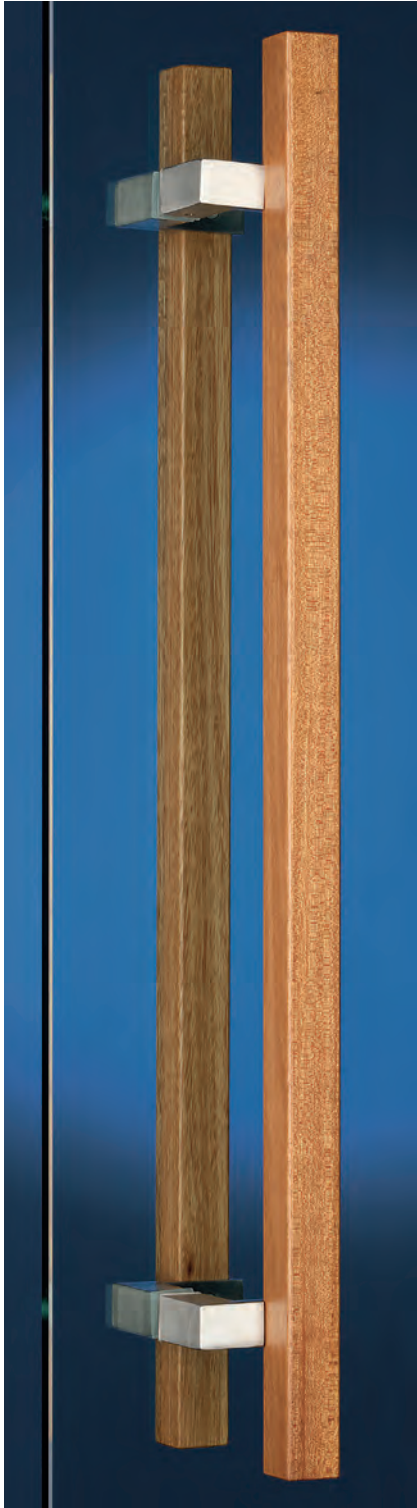

Product No.	Fixing Centres mm	Rail Section mm	Unit	Projection mm	Overall Length mm
-------------	-------------------	-----------------	------	---------------	-------------------

Back to Back Fix

MDZ B8520	1500	32x32	Pair	77	1660
MDZ B8520	1000	32x32	Pair	77	1160
MDZ B8520	800	32x32	Pair	77	960
MDZ B8520	600	32x32	Pair	77	760
MDZ B8520	400	32x32	Pair	77	560

Disk Fix

MDZ D8520	1500	32x32	Single	77	1660
MDZ D8520	1000	32x32	Single	77	1160
MDZ D8520	800	32x32	Single	77	960
MDZ D8520	600	32x32	Single	77	760
MDZ D8520	400	32x32	Single	77	560

Concealed Fix

MDZ C8520	1500	32x32	Single	77	1660
MDZ C8520	1000	32x32	Single	77	1160
MDZ C8520	800	32x32	Single	77	960
MDZ C8520	600	32x32	Single	77	760
MDZ C8520	400	32x32	Single	77	560

NOTE:
Special sizes available on request
Other timbers available on request



HOW TO SPECIFY

Product No. / Fixing Centres / Rail Section / Finish / Fixing (refer diagram below)
eg: B8520 / 1500 / 32x32 / SSS / TM

B = BACK TO BACK FIX

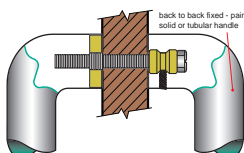

D = DISK FIX

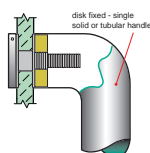

C = CONCEALED FIX

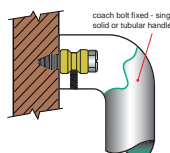

PLEASE SPECIFY DOOR TYPE
GD - Glass doors
TM - Timber doors
AL - Aluminium doors

Entry Door Pull Handle

Material 316 Marine Grade Stainless Steel
Insert Melunak (Plantation Grown Hardwood)



Product No.	Fixing Centres mm	Rail Section mm	Unit	Projection mm	Overall Length mm
-------------	-------------------	-----------------	------	---------------	-------------------

Back to Back Fix

MDZ B8525	1500	32x32	Pair	77	1660
MDZ B8525	1000	32x32	Pair	77	1160
MDZ B8525	800	32x32	Pair	77	960
MDZ B8525	600	32x32	Pair	77	760
MDZ B8525	400	32x32	Pair	77	560

Disk Fix

MDZ D8525	1500	32x32	Single	77	1660
MDZ D8525	1000	32x32	Single	77	1160
MDZ D8525	800	32x32	Single	77	960
MDZ D8525	600	32x32	Single	77	760
MDZ D8525	400	32x32	Single	77	560

Concealed Fix

MDZ C8525	1500	32x32	Single	77	1660
MDZ C8525	1000	32x32	Single	77	1160
MDZ C8525	800	32x32	Single	77	960
MDZ C8525	600	32x32	Single	77	760
MDZ C8525	400	32x32	Single	77	560

NOTE:
Special sizes available on request
Other timbers available on request



HOW TO SPECIFY

Product No. / Fixing Centres / Rail Section / Finish / Fixing (refer diagram below)
eg: B8525 / 1500 / 32x32 / SSS / TM

B = BACK TO BACK FIX

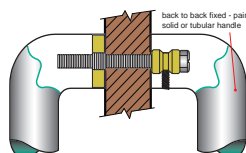

D = DISK FIX

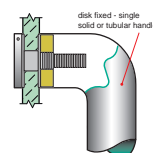

C = CONCEALED FIX

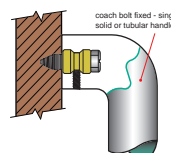

PLEASE SPECIFY DOOR TYPE
GD - Glass doors
TM - Timber doors
AL - Aluminium doors

Entry Door Pull Handle

Material 316 Marine Grade Stainless Steel
Insert Melunak (Plantation Grown Hardwood)



Product No.	Fixing Centres mm	Rail Section mm	Unit	Projection mm	Overall Length mm
-------------	-------------------	-----------------	------	---------------	-------------------

Back to Back Fix

MDZ B8530	1500	32x32	Pair	77	1660
MDZ B8530	1000	32x32	Pair	77	1160
MDZ B8530	800	32x32	Pair	77	960
MDZ B8530	600	32x32	Pair	77	760
MDZ B8530	400	32x32	Pair	77	560

Disk Fix

MDZ D8530	1500	32x32	Single	77	1660
MDZ D8530	1000	32x32	Single	77	1160
MDZ D8530	800	32x32	Single	77	960
MDZ D8530	600	32x32	Single	77	760
MDZ D8530	400	32x32	Single	77	560

Concealed Fix

MDZ C8530	1500	32x32	Single	77	1660
MDZ C8530	1000	32x32	Single	77	1160
MDZ C8530	800	32x32	Single	77	960
MDZ C8530	600	32x32	Single	77	760
MDZ C8530	400	32x32	Single	77	560

NOTE:
Special sizes available on request
Other timbers available on request



HOW TO SPECIFY

Product No. / Fixing Centres / Rail Section / Finish / Fixing (refer diagram below)
eg: B8530 / 1500 / 32x32 / SSS / TM

B = BACK TO BACK FIX

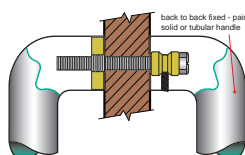

D = DISK FIX

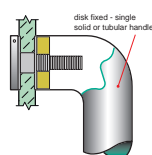

C = CONCEALED FIX

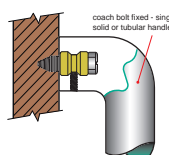

PLEASE SPECIFY DOOR TYPE
GD - Glass doors
TM - Timber doors
AL - Aluminium doors

Entry Door Pull Handle

Material 316 Marine Grade Stainless Steel
Insert Melunak (Plantation Grown Hardwood)



Product No.	Fixing Centres mm	Rail Section mm	Unit	Projection mm	Overall Length mm
-------------	-------------------	-----------------	------	---------------	-------------------

Back to Back Fix

MDZ B8535	1500	32x32	Pair	77	1660
MDZ B8535	1000	32x32	Pair	77	1160
MDZ B8535	800	32x32	Pair	77	960
MDZ B8535	600	32x32	Pair	77	760
MDZ B8535	400	32x32	Pair	77	560

Disk Fix

MDZ D8535	1500	32x32	Single	77	1660
MDZ D8535	1000	32x32	Single	77	1160
MDZ D8535	800	32x32	Single	77	960
MDZ D8535	600	32x32	Single	77	760
MDZ D8535	400	32x32	Single	77	560

Concealed Fix

MDZ C8535	1500	32x32	Single	77	1660
MDZ C8535	1000	32x32	Single	77	1160
MDZ C8535	800	32x32	Single	77	960
MDZ C8535	600	32x32	Single	77	760
MDZ C8535	400	32x32	Single	77	560

NOTE:
Special sizes available on request
Other timbers available on request



HOW TO SPECIFY

Product No. / Fixing Centres / Rail Section / Finish / Fixing (refer diagram below)

eg: B8535 / 1500 / 32x32 / SSS / TM

B = BACK TO BACK FIX

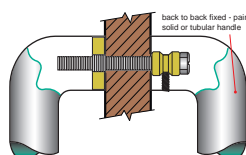

D = DISK FIX

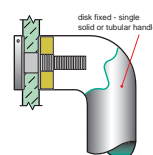

C = CONCEALED FIX

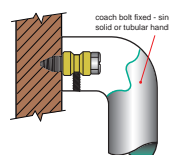

PLEASE SPECIFY DOOR TYPE

GD - Glass doors

TM - Timber doors

AL - Aluminium doors

Entry Door Pull Handle

Material 316 Marine Grade Stainless Steel
Insert Melunak (Plantation Grown Hardwood)



Product No.	Fixing Centres mm	Flat Plate mm	Unit	Projection mm	Width mm	Overall Length mm
Back to Back Fix						
MDZ B8540	200	32	Pair	77	150	400
Disk Fix						
MDZ D8540	200	32	Single	77	150	400
Concealed Fix						
MDZ C8540	200	32	Single	77	150	400

Entry Door Pull Handle

Material 316 Marine Grade Stainless Steel
Insert Melunak (Plantation Grown Hardwood)



Product No.	Fixing Centres mm	Flat Plate mm	Unit	Projection mm	Width mm	Overall Length mm
Back to Back Fix						
MDZ B8545	200	32	Pair	77	150	400
Disk Fix						
MDZ D8545	200	32	Single	77	150	400
Concealed Fix						
MDZ C8545	200	32	Single	77	150	400

Entry Door Pull Handle

Material 316 Marine Grade Stainless Steel
Insert Melunak (Plantation Grown Hardwood)



Product No.	Fixing Centres mm	Diameter mm	Unit	Projection mm	Disc mm
Back to Back Fix					
MDZ B8550	150	300	Pair	77	32
MDZ B8550	100	200	Pair	77	32
Disk Fix					
MDZ D8550	150	300	Single	77	32
MDZ D8550	100	200	Single	77	32
Concealed Fix					
MDZ C8550	150	300	Single	77	32
MDZ C8550	100	200	Single	77	32

NOTE:
Special sizes available on request

Other timbers available on request

Entry Door Pull Handle

Material 316 Marine Grade Stainless Steel
Insert Melunak (Plantation Grown Hardwood)



Product No.	Fixing Centres mm	Diameter mm	Unit	Projection mm	Disc mm
Back to Back Fix					
MDZ B8555	150	300	Pair	77	32
MDZ B8555	100	200	Pair	77	32
Disk Fix					
MDZ D8555	150	300	Single	77	32
MDZ D8555	100	200	Single	77	32
Concealed Fix					
MDZ C8555	150	300	Single	77	32
MDZ C8555	100	200	Single	77	32

NOTE:
Special sizes available on request

Other timbers available on request

Entry Door Pull Handle

Material 316 Marine Grade Stainless Steel
Insert Melunak (Plantation Grown Hardwood)



Product No.	Fixing Centres mm	Section mm	Unit	Projection mm
-------------	-------------------	------------	------	---------------

Back to Back Fix

MDZ B8560	100	200x200	Pair	77
------------------	-----	---------	------	----

Disk Fix

MDZ D8560	100	200x200	Single	77
------------------	-----	---------	--------	----

Concealed Fix

MDZ C8560	100	200x200	Single	77
------------------	-----	---------	--------	----

NOTE:
Special sizes available
on request

Other timbers
available on request

Entry Door Pull Handle

Material 316 Marine Grade Stainless Steel
Insert Melunak (Plantation Grown Hardwood)



Product No.	Fixing Centres mm	Section mm	Unit	Projection mm
-------------	-------------------	------------	------	---------------

Back to Back Fix

MDZ B8565	100	200x200	Pair	77
-----------	-----	---------	------	----

Disk Fix

MDZ D8565	100	200x200	Single	77
-----------	-----	---------	--------	----

Concealed Fix

MDZ C8565	100	200x200	Single	77
-----------	-----	---------	--------	----

NOTE:
Special sizes available
on request

Other timbers
available on request

Entry Door Pull Handle

Material 316 Marine Grade Stainless Steel
Insert Melunak (Plantation Grown Hardwood)



Product No.	Diameter mm	Projection mm	Length mm	Fixing Centres mm
MDZ 8570/A	32	77	2400	2240
MDZ 8570/B	32	77	2300	2140
MDZ 8570/C	32	77	2200	2040
MDZ 8570/D	32	77	2100	1940
MDZ 8570/E	32	77	2000	1840
MDZ 8570/F	32	77	1900	1740
MDZ 8570/G	32	77	1800	1640
MDZ 8570/H	32	77	1700	1540
MDZ 8570/I	32	77	1600	1440
MDZ 8570/J	32	77	1500	1340
MDZ 8570/K	32	77	1400	1240
MDZ 8570/L	32	77	1300	1140
MDZ 8570/M	32	77	1200	1040
MDZ 8570/N	32	77	1100	940
MDZ 8570/O	32	77	1000	840
MDZ 8570/P	32	77	900	740
MDZ 8570/Q	32	77	800	640
MDZ 8570/R	32	77	700	540
MDZ 8570/S	32	77	600	440
MDZ 8570/T	32	77	500	340
MDZ 8570/U	32	77	400	240

NOTE:
MDZ 8570/A to E to come with 3 stand offs (fixing points)
Special sizes available on request
Other timbers available on request



HOW TO SPECIFY

Product No. / Diameter / Projection / Finish / Fixing (refer diagram below)

eg: 8570A / 32 / 77 / SSS / TM

B = BACK TO BACK FIX

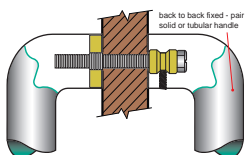

D = DISK FIX

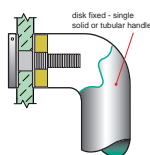

C = CONCEALED FIX

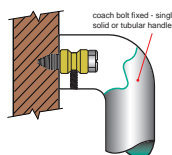

PLEASE SPECIFY DOOR TYPE
GD - Glass doors
TM - Timber doors
AL - Aluminium doors

Entry Door Pull Handle

Material 316 Marine Grade Stainless Steel
Insert Melunak (Plantation Grown Hardwood)



Product No.	Diameter mm	Projection mm	Length mm	Fixing Centres mm
MDZ 8575/A	32	77	2400	2240
MDZ 8575/B	32	77	2300	2140
MDZ 8575/C	32	77	2200	2040
MDZ 8575/D	32	77	2100	1940
MDZ 8575/E	32	77	2000	1840
MDZ 8575/F	32	77	1900	1740
MDZ 8575/G	32	77	1800	1640
MDZ 8575/H	32	77	1700	1540
MDZ 8575/I	32	77	1600	1440
MDZ 8575/J	32	77	1500	1340
MDZ 8575/K	32	77	1400	1240
MDZ 8575/L	32	77	1300	1140
MDZ 8575/M	32	77	1200	1040
MDZ 8575/N	32	77	1100	940
MDZ 8575/O	32	77	1000	840
MDZ 8575/P	32	77	900	740
MDZ 8575/Q	32	77	800	640
MDZ 8575/R	32	77	700	540
MDZ 8575/S	32	77	600	440
MDZ 8575/T	32	77	500	340
MDZ 8575/U	32	77	400	240

NOTE:

MDZ 8575/A to E to come with 3 stand offs (fixing points)

Special sizes available on request

Other timbers available on request



HOW TO SPECIFY

Product No. / Diameter / Projection / Finish / Fixing (refer diagram below)

eg: 8575A / 32 / 77 / SSS / TM

B = BACK TO BACK FIX

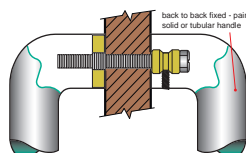

D = DISK FIX

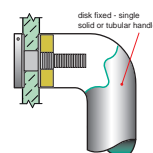

C = CONCEALED FIX

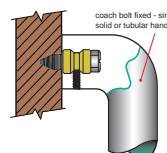

PLEASE SPECIFY DOOR TYPE

GD - Glass doors

TM - Timber doors

AL - Aluminium doors

Entry Door Pull Handle

Material 316 Marine Grade Stainless Steel



Product No.	Fixing Centres mm	Diameter mm	Unit	Projection mm	Disc mm
Back to Back Fix					
MDZ B8580	150	300	Pair	77	8
MDZ B8580	100	200	Pair	77	8
Disk Fix					
MDZ D8580	150	300	Single	77	8
MDZ D8580	100	200	Single	77	8
Concealed Fix					
MDZ C8580	150	300	Single	77	8
MDZ C8580	100	200	Single	77	8

NOTE:
Special sizes available
on request

Entry Door Pull Handle

Material 316 Marine Grade Stainless Steel

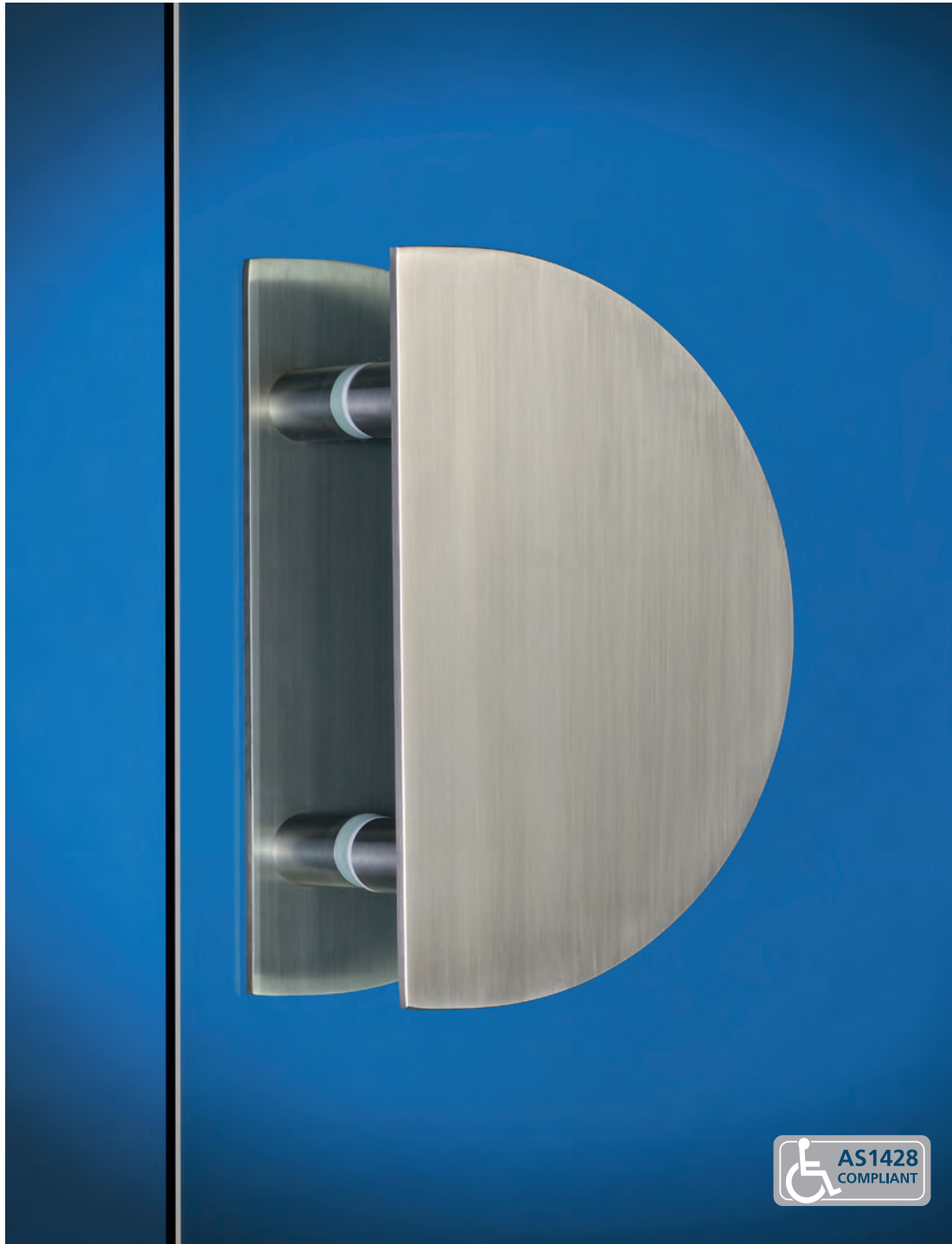

Product No.	Fixing Centres mm	Flat Plate mm	Unit	Projection mm	Width mm	Overall Length mm
Back to Back Fix						
MDZ B8590	150	8	Pair	51	150	250
Disk Fix						
MDZ D8590	150	8	Single	51	150	250
Concealed Fix						
MDZ C8590	150	8	Single	51	150	250



For further information please contact Madinoz.
Unit 3 / 1-7 Ada Avenue, Brookvale NSW 2100 Australia
Telephone: **(02) 9939 2007**
Facsimile: (02) 9939 8432
E-mail: sales@madinoz.com.au
Website: www.madinoz.com.au