

The Fence Book





Auckland



Christchurch



Invercargill

We make fencing **easy**_____

Who we are

Innovation has been at the heart of what we do at Boundaryline Fencing Systems since the company was founded in Invercargill, with a range of timber Post&Rail fencing many years ago. We quickly found there were people throughout the New Zealand construction industry that liked our way of doing things, so our range of fencing systems grew quickly to meet the requirements of the market.

With the widest range of fencing systems available on the New Zealand market and located in Auckland, Christchurch, and Invercargill – we have the products, service and attitude to make fencing easy for you.

Our promise

We're a customer focused team, dedicated to making it easy for anyone in New Zealand to get the fence they need. We listen to what you tell us and work with you to reach the best solution for your project.

Our values



Right thing, right now

- Integrity, fairness & respect is non-negotiable
- Act professionally & be authentic
- Be a role model; for each other, & the brand



Together we win

- One team; whatever your role, wherever you are
- Every interaction must be a win-win
- Celebrate the successes and learn from the losses



Dig deep when it matters

- We're diligent & dependable
- Prioritise; focus on what's important now
- Go the extra mile, do what needs to be done



Seize the opportunity

- Better never stops; challenge the status quo
- Take action; time waits for no one
- There's a solution to every problem, & an opportunity in every challenge



DURAPANEL



Smart fencing for homes, pools and schools

Boundaryline DuraPanel tubular metal fencing offers a wide range of options for pool fencing, landscape fencing, schools and childcare centres. With high quality components and a sleek, cohesive design, DuraPanel complies with all New Zealand pool fencing regulations to keep children safe and to meet council requirements.

Our DuraPanel aluminium range is designed for durability and offers great looking property enhancement and protection at a cost effective price.

The DuraPanel range of custom made fencing offers a wide variety of styles and colours to meet specific design requirements for any project.

All DuraPanel fencing is designed to be simple and quick to install, with modular components and welded panels.

Producer statements are available for pool fencing, balustrade, and retaining wall fencing compliance.



Delta



Panel height — 950 / 1200mm
 Panel length — 2250mm
 Horizontal rails — 40x40mm
 Vertical bars — 19x19mm
 Vertical bar spacing — 95mm
 Post size — 50x50mm

DuraPanel is F4 (Fall from Height) and F9 (Pool Safety) compliant

Vecta



Panel height — 1200 / 1500mm
 Panel length — 2250mm
 Horizontal rails — 40x40mm
 Vertical bars — 19x19mm
 Vertical bar spacing — 95mm
 Post size — 50x50mm

*DuraPanel is F4 (Fall from Height) and F9 (Pool Safety) compliant
 Reversible, can be installed with rods facing down*

Polo



Panel height — 1200 / 1500 / 1800mm
 Panel length — 2250mm
 Horizontal rails — 40x40mm
 Vertical bars — 19x19mm
 Vertical bar spacing — 95mm
 Post size — 50x50 / 65x65mm

DuraPanel is F4 (Fall from Height) and F9 (Pool Safety) compliant

Axis



Panel height — 1200mm
 Panel length — 2250mm
 Horizontal rails — 25x25mm
 Vertical bars — 50x25mm
 Vertical bar spacing — 95mm
 Post size — 50x25mm

DuraPanel is F4 (Fall from Height) and F9 (Pool Safety) compliant

Titan



Panel height — 1200mm
 Panel length — 2330mm
 Horizontal rails — 50x25mm
 Vertical bars — 19x19mm
 Vertical bar spacing — 93mm
 Post size — 65x65mm

DuraPanel is F4 (Fall from Height) and F9 (Pool Safety) compliant



High Quality

Powder coated finish is standard in black with custom options available

Quick & Simple Installation

Modular system with screw on brackets

Strong Rails

40x40mm rails (Titan - 50x25mm)

Square Verticals

19x19mm for added strength and better appearance

Pool Safety Design

Keeps children safe and meets all regulations. Refer to PS1 for guidance



For more inspiration, scan the QR code or visit <https://www.boundaryline.co.nz/inspiration/>

Delta

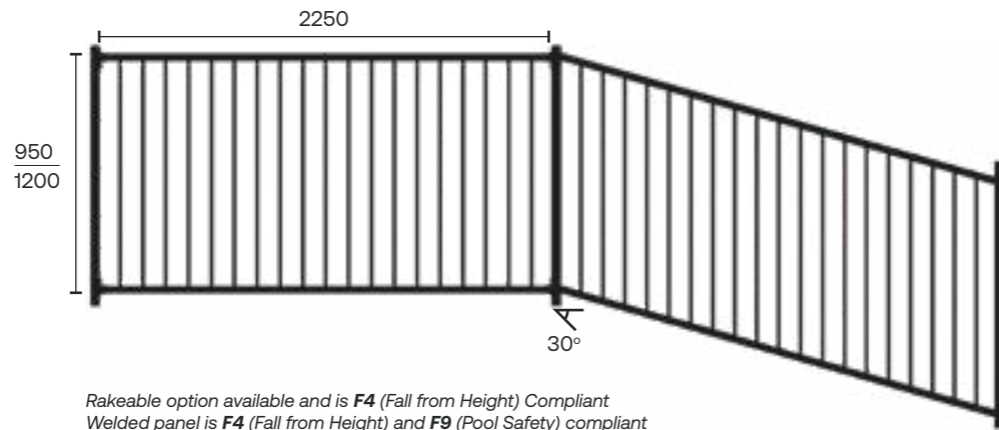

Vecta

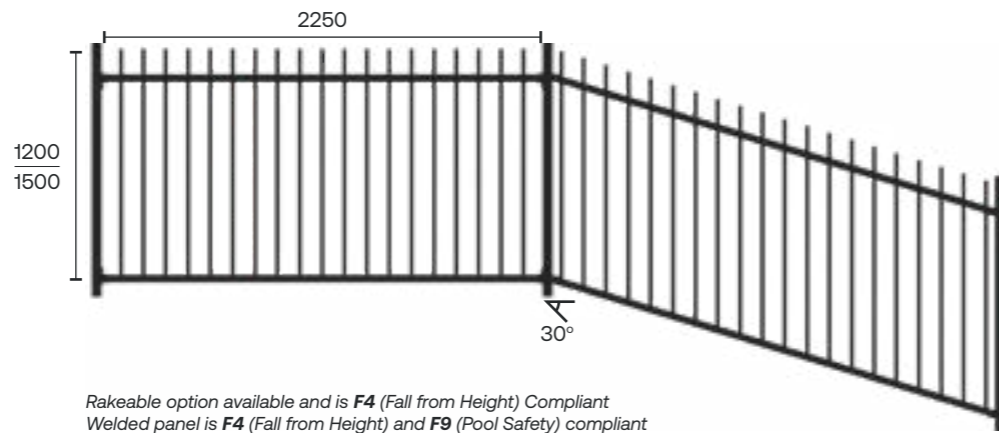

Polo

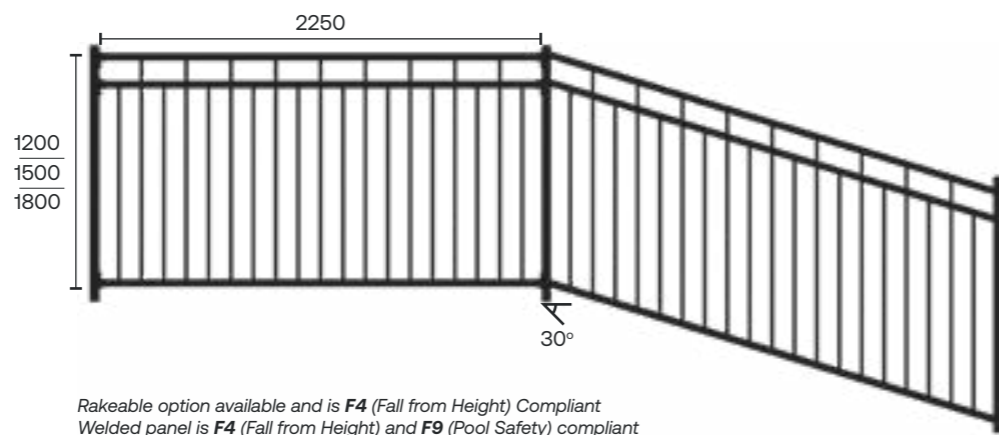

Axis

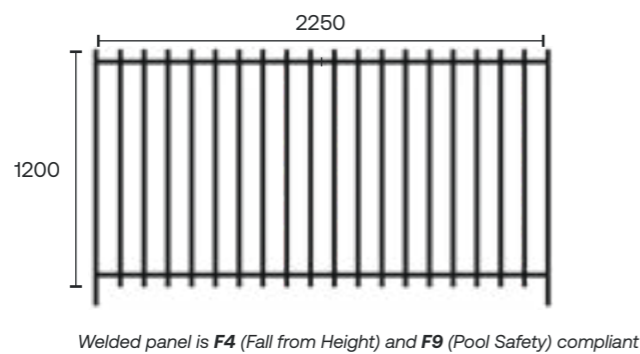

Safety Fencing

F4 Safety From Falling compliant

For some applications extra strength is required. In our DuraPanel range we have design engineered the Delta 35 and Titan safety fencing with extra reinforcement to comply with F4 Safety From Falling Compliance, when installed to manufacturers specifications. It is New Zealand's first aluminium safety fence that can be installed at 2400mm centres while meeting the NZBC F4 specification requirements.



Delta 35

Specifications

- Panel heights:** 950mm / 1200mm (approx 1000mm / 1250mm high when installed)
- Panel lengths:** 2250mm
- Post Centre:** 2300mm max post centres with 65x65mm posts

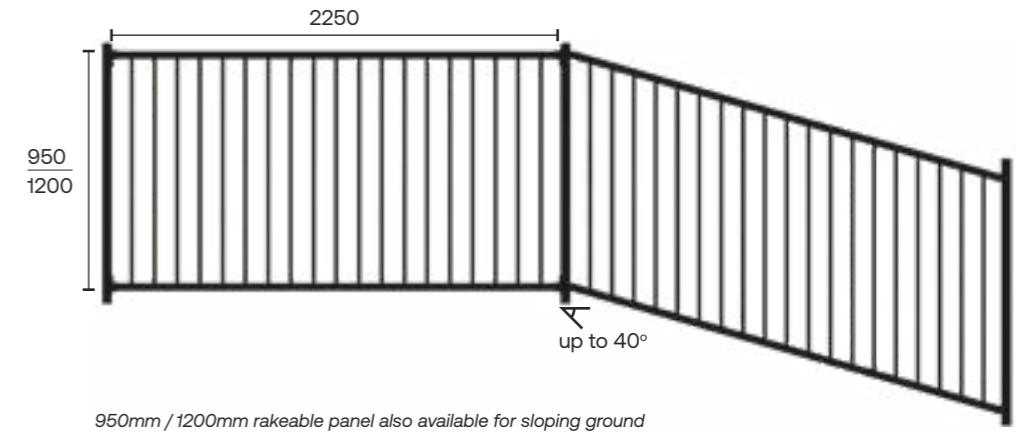

Titan

Specifications

- Panel height:** 1200mm (approx 1250mm high when installed)
- Panel lengths:** 2330mm
- Post Centre:** 2395mm max post centres with 65x65mm posts

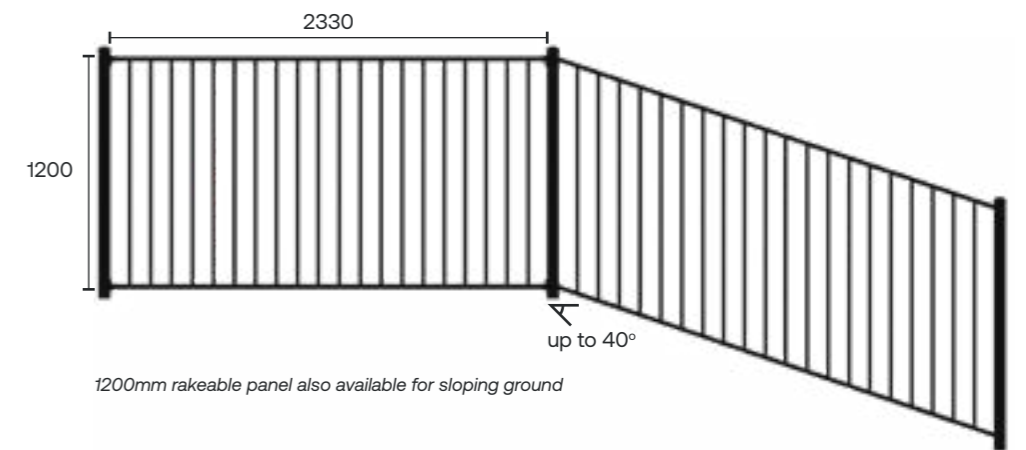

Fixing Solutions

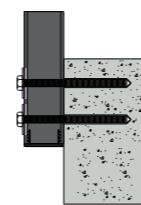

Side fixed to concrete

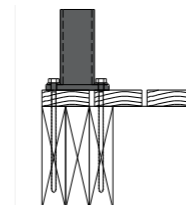

Top fixed to timber deck

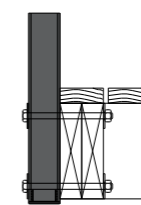

Side fixed to timber deck

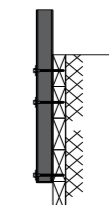

Side fixed to single board retaining wall

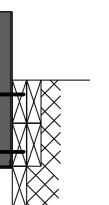

Side fixed to double board retaining wall

Pedestrian & Driveway Gates

Delta



Height _____ 950 / 1200mm
 Length _____ 950 / 1200mm
 Horizontal rail _____ 40x40mm
 Vertical bars _____ 19x19mm
 Stiles _____ 50x50/40x40mm



Height _____ 950 / 1200mm
 Length _____ 1000 - 2300mm
 Horizontal rail _____ 40x40mm
 Vertical bars _____ 19x19mm
 Stiles _____ 50x50mm

Vecta



Height _____ 1200 / 1500mm
 Length _____ 950mm
 Horizontal rail _____ 40x40mm
 Vertical bars _____ 19x19mm
 Stiles _____ 50x50mm



Height _____ 1200 / 1500mm
 Length _____ 1000 - 2300mm
 Horizontal rail _____ 40x40mm
 Vertical bars _____ 19x19mm
 Stiles _____ 50x50mm

Polo



Height _____ 1200 / 1500 / 1800mm
 Length _____ 950mm
 Horizontal rail _____ 40x40mm
 Vertical bars _____ 19x19mm
 Stiles _____ 50x50mm



Height _____ 1200 / 1500 / 1800mm
 Length _____ 1000 - 2300mm
 Horizontal rail _____ 40x40mm
 Vertical bars _____ 19x19mm
 Stiles _____ 50x50mm

Axis



Height _____ 1200mm
 Length _____ 950mm
 Horizontal rail _____ 25x25mm
 Vertical bars _____ 50x25mm
 Stiles _____ 50x50mm



Height _____ 1200mm
 Length _____ 1000 - 2300mm
 Horizontal rail _____ 50x50mm
 Vertical bars _____ 50x25mm
 Stiles _____ 50x50mm

Titan



Height _____ 1200mm
 Length _____ 950mm
 Horizontal rail _____ 50x25mm
 Vertical bars _____ 19x19mm
 Stiles _____ 50x50mm



Height _____ 1200mm
 Length _____ 1000 - 2300mm
 Horizontal rail _____ 50x25mm
 Vertical bars _____ 19x19mm
 Stiles _____ 50x50mm

Sliding Gates

Delta



Height _____ 950 / 1200mm
 Length _____ up to 6000mm
 Horizontal rail _____ 40x40mm
 Vertical bars _____ 19x19mm
 Stiles _____ 50x50mm

Vecta



Height _____ 1200 / 1500mm
 Length _____ up to 6000mm
 Horizontal rail _____ 40x40mm
 Vertical bars _____ 19x19mm
 Stiles _____ 50x50mm

Polo



Height _____ 1200 / 1500 / 1800mm
 Length _____ up to 6000mm
 Horizontal rail _____ 40x40mm
 Vertical bars _____ 19x19mm
 Stiles _____ 50x50mm

Axis



Height _____ 1200mm
 Length _____ up to 6000mm
 Horizontal rail _____ 50x50mm
 Vertical bars _____ 50x25mm
 Stiles _____ 50x50mm

Titan



Height _____ 1200mm
 Length _____ up to 6000mm
 Horizontal rail _____ 50x25mm
 Vertical bars _____ 19x19mm
 Stiles _____ 50x50mm



SENTRY PANEL



SentryPanel Spear Top

New Zealand's premium security fencing

Boundaryline SentryPanel is designed to provide superior protection for your investment while looking great at the same time.

The Spear Top option has sharply spiked bars to deter intruders, and Rod Top provides the same security without looking too unfriendly. Both styles have a long anti-climb gap, making it a virtually unscalable barrier.

SentryPanel is constructed from heavy wall aluminium componentry, welded for strength and powder coated for long term durability. The modular design and comparatively light panel weight makes installation quick and easy.

SentryPanel is a smart, cost effective security fencing solution for all types of commercial property.



SentryPanel School Panel



SentryPanel Rod Top

Spear Top



Panel height — 1800 / 2100mm
 Panel length — 2250mm
 Horizontal rails — 40x40mm
 Vertical bars — 25x25mm
 Vertical bar spacing — 110mm
 Post size — 65x65mm

Rod Top



Panel height — 1800mm
 Panel length — 2250mm
 Horizontal rails — 40x40mm
 Vertical bars — 25x25mm
 Vertical bar spacing — 110mm
 Post size — 65x65mm

Flat Top



Panel height — 1500 / 1800mm
 Panel length — 2250mm
 Horizontal rails — 40x40mm
 Vertical bars — 25x25mm
 Vertical bar spacing — 95mm
 Post size — 65x65mm

*Custom manufactured steel products available on request
 Flat Top is F4 (Fall From Height) and F9 (Pool Fencing) compliant*

School Panel



Panel height — 1500 / 1800mm
 Panel length — 2250mm
 Horizontal rails — 40x40mm
 Vertical bars — 25x25mm
 Vertical bar spacing — 95mm
 Post size — 65x65mm

*Custom manufactured steel products available on request
 School Panel is F4 (Fall From Height) and F9 (Pool Fencing) compliant*



Intruder Deterrent

Spear Top and Rod Top options to deter potential intruders

High Quality

Powder coated finish is standard in black with custom options available

Quick & Simple Installation

Modular system with screw on brackets

Strong Rails

40x40mm rails

Square Verticals

25x25mm for added strength and better appearance

Aluminium Construction

This fence won't rust



For more inspiration, scan the QR code or visit <https://www.boundaryline.co.nz/inspiration/>

SENTRY PANEL

Technical Drawings

Rod Top

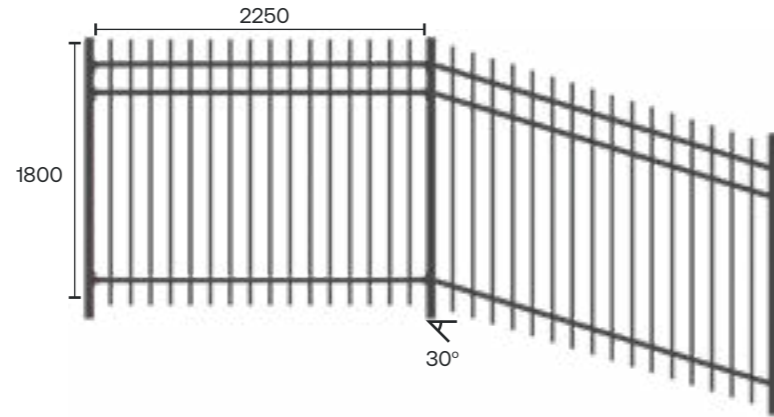

Spear Top

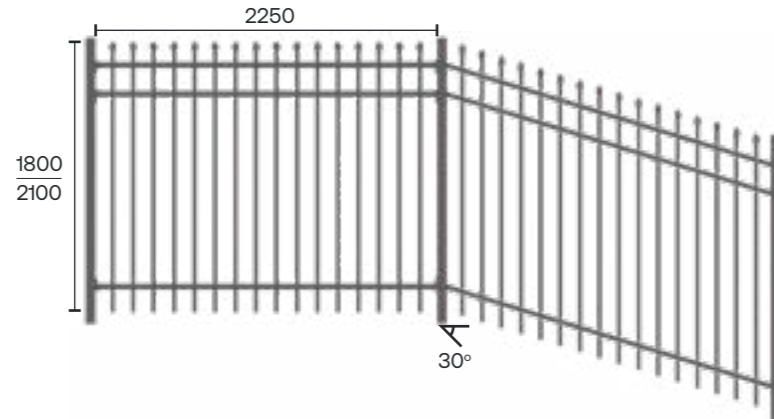

Flat Top

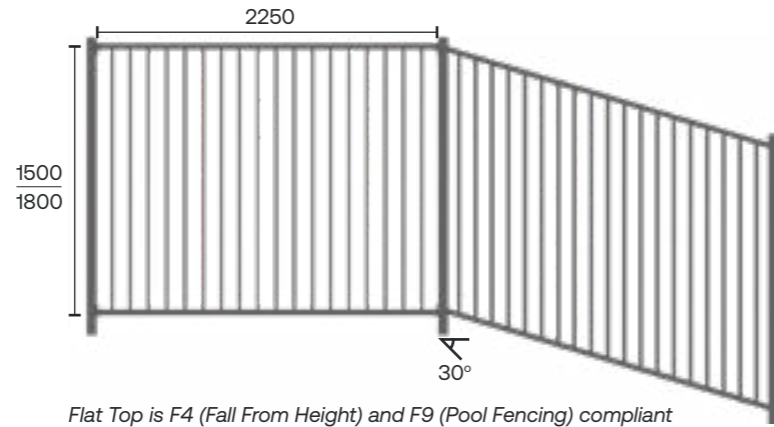

Flat Top is F4 (Fall From Height) and F9 (Pool Fencing) compliant

School Panel

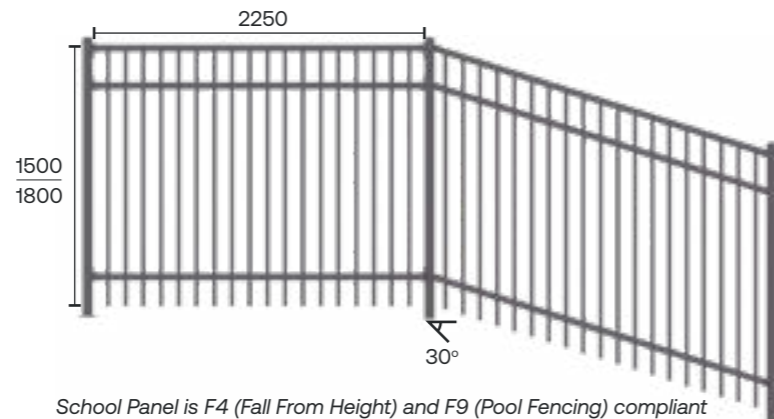

School Panel is F4 (Fall From Height) and F9 (Pool Fencing) compliant

Security Gate Solutions

Many commercial and industrial properties require a high level of security to limit unauthorised access.

Boundaryline works with construction companies, property owners and designers all over New Zealand to deliver reliable security gate solutions for all kinds of applications.

SentryPanel gates are manufactured using standard in stock componentry to achieve a quick, cost effective solution that will perform to perfection for the long term.

Visit boundaryline.co.nz to download Producer Statements, Technical Support and CAD drawing files.

Swinging gates

Swinging gates are the most cost effective option when there is enough opening space or when the entrance way is not level. They can be automated if required but are usually used when the gates are not opened frequently

Tracked sliding gates

Where traffic is relatively light but a sliding gate is required, a tracked gate provides a cost effective solution. The ground track is very low profile and this type can be used with or without an automated opener

Cantilever sliding gates

Boundaryline has had extensive experience in designing and building cantilevered sliding gates. With no ground track required, a cantilevered gate is ideal for industrial situations that have heavy traffic or where the entrance way is not level

Custom designs

We can supply custom made gates to meet your design requirements

For Flat Top and School Panel fencing to comply with F4 and F9 NZBC requirements, all product must be installed as per Boundaryline's PS1, available at boundaryline.co.nz/technical-resources



SentryPanel Spear Top



SentryPanel Spear Top



SentryPanel Spear Top



SentryPanel Spear Top



SentryPanel Spear Top



SLEEKWALL



SleekWall Slat & Solid Vertical

The premium fence and screen solution

The premium design in fencing, Boundaryline SleekWall is for the designers and discerning homeowners who want to make their boundary a feature and a statement.

Designed to be quick and simple to install, with modular components and hidden fixings, SleekWall provides the ultimate minimalist look.

Add value to your home with contemporary fencing, featuring strong aluminium construction, with no twisting or warping, and low maintenance. SleekWall provides you with options; solid, slat or slat top.

It's the modern fence you'll love forever.



SleekWall Slat Vertical



SleekWall Solid Vertical

SLEEKWALL

Design Options

Design Features

Slat Horizontal



Panel height — 1200 / 1500 / 1800mm
 Post centres — 1865mm
 Slat size — 100x16mm
 Slat spacing — 18mm
 Panel profile — Aluminium slat
 Post size — 65x65mm

Slat Vertical



Panel height — 1800mm
 Post centres — 1837mm
 Slat size — 100x16mm
 Slat spacing — 18mm
 Panel profile — Aluminium slat
 Post size — 65x65mm

Solid Horizontal



Panel height — 1200 / 1500 / 1800mm
 Post centres — 1865mm
 Paling size — 145x16mm
 Panel profile — Aluminium paling
 Post size — 65x65mm

Solid Vertical



Panel height — 1800mm
 Post centres — 1820mm
 Paling size — 145x16mm
 Panel profile — Aluminium paling
 Post size — 65x65mm

Slat Top



Panel height — 1800mm
 Post centres — 1865mm
 Paling size — 145x16mm
 Slat size — 100x16mm
 Slat spacing — 18mm
 Panel profile — Aluminium paling and slat
 Post size — 65x65mm



Slats or Paling

Available with slats for screen solution or T&G paling for solid fence

Aluminium Construction

Strength, durability and low maintenance

Quick & Simple Installation

Modular system with screw on channels, one screw per paling is all that is required

Pre-finished Modular Components

All parts are colour matched with our simple modular system and hidden fixings for a clean, refined profile

Available colours

Black Thunder



For more inspiration, scan the QR code or visit <https://www.boundaryline.co.nz/inspiration/>

Slat Horizontal

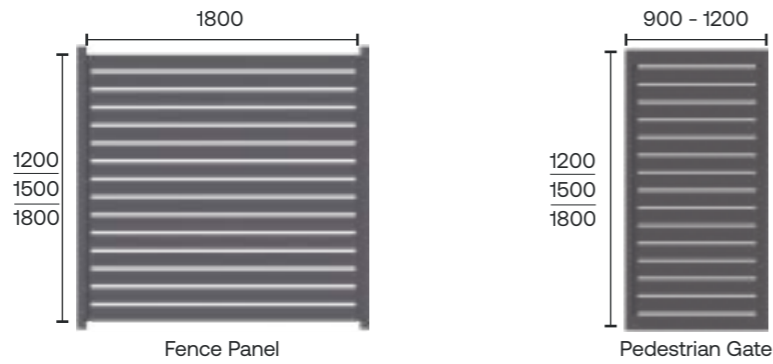

Slat Vertical

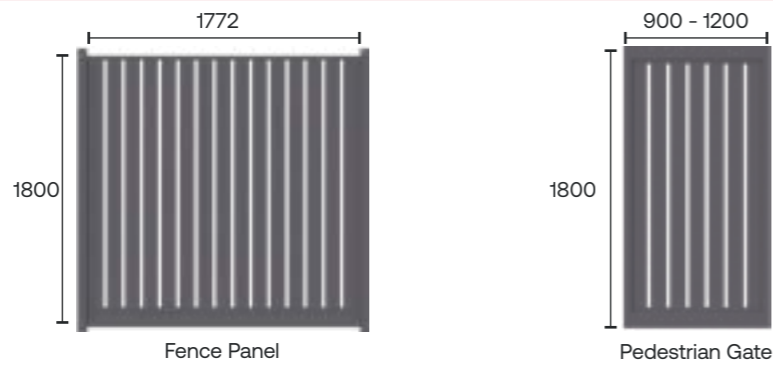

Solid Horizontal

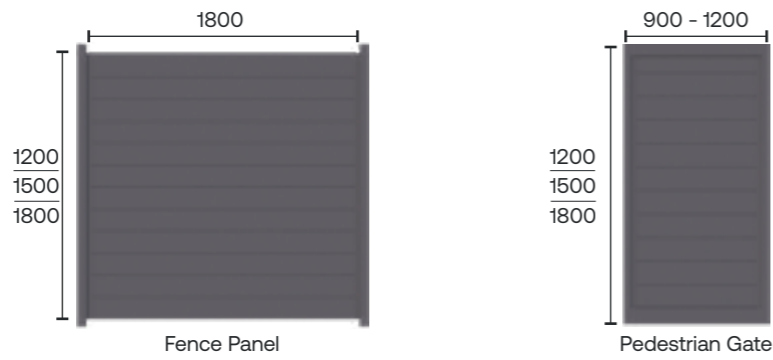

Solid Vertical

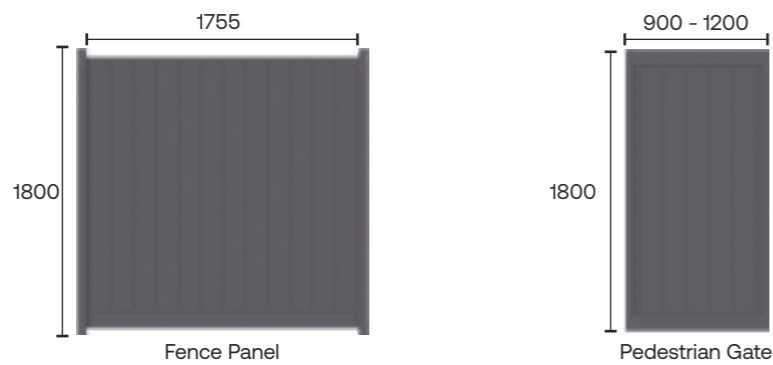

Slat Top

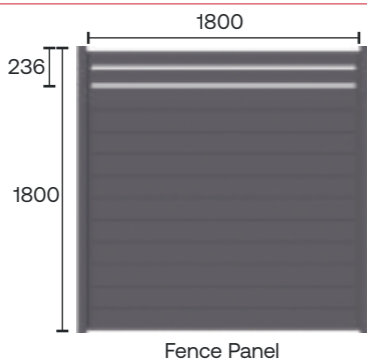

Driveway Gates

Double swing or sliding gate configurations custom manufactured on request

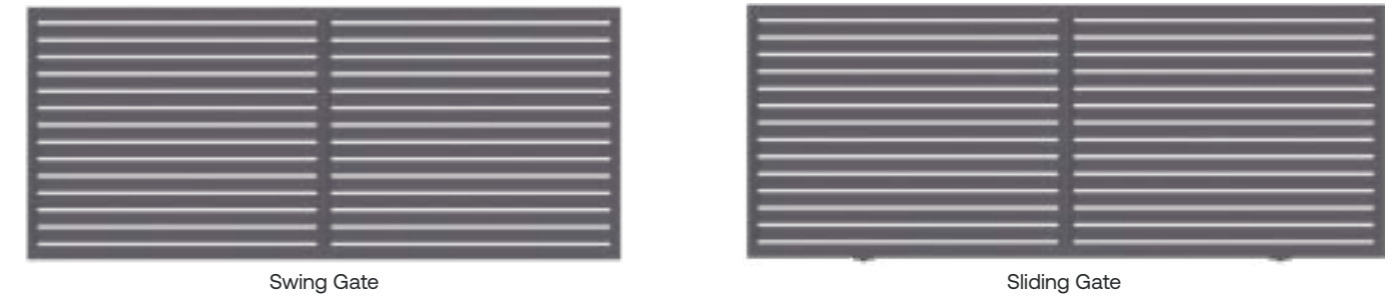

Kitset Pedestrian Gates

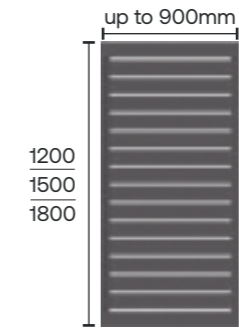

Kitset includes all components required to make one pedestrian gate at up to 900mm wide. Includes; Slats, end-channels with capping, tek-screws and standard gate hardware.

Modular design for quick and easy installation

The SleekWall system design allows for a quick and effective installation process and all components are designed to seamlessly connect together with all fixings hidden.

By utilising the Slat and T&G options a single fenceline can have varying degrees of permeability to meet the project privacy requirements.

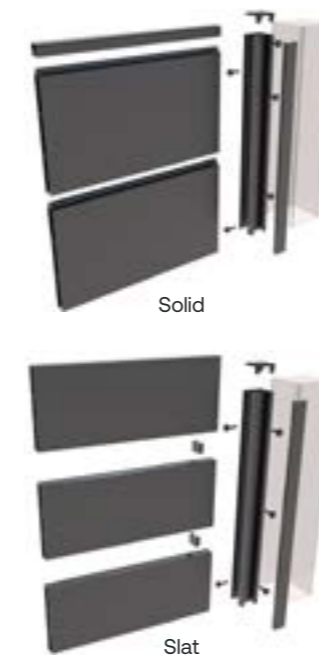



SMARTWALL



Blending seamlessly
with natural
surroundings

Create beautiful natural boundaries to complement your new landscape with Boundaryline's smart alternative for timber fencing.

SmartWall features steel posts and rails with CLT (Cross Laminated Timber) palings to prevent twisting and warping over time, ensuring you have a premium looking boundary solution for years to come.

With CLT palings and the same-both-sides look, SmartWall creates a tidy, elegant finish with ultimate stability for every project.

The superior acoustic performance of SmartWall makes it the ideal choice for residential and commercial projects including child care centres and rest homes where noise minimisation is a requirement.

The modular construction makes SmartWall one of the easiest and fastest fences to install, saving you time and money.



SmartWall Vertical



SmartWall Vertical

SmartWall Vertical

Vertical



Panel height — 1800mm
 Post Centre — 2250mm
 Paling profile — CLT palings
 Post size — 65x65mm

Horizontal



Panel height — 1200 / 1500 / 1800mm
 Post Centre — 1830mm
 Paling profile — CLT palings
 Post size — 65x65mm

Slat Top



Panel height — 1200 / 1500 / 1800mm
 Post Centres *horizontal* — 1830mm
 Post Centres *vertical* — 2250mm
 Paling profile — CLT palings
 Post size — 65x65mm



Complete Privacy

CLT (Cross Laminated Timber) palings are tongue and groove to prevent any gaps

Ultimate Stability Radiata Pine

CLT palings for ultimate stability

Stainable Palings

Palings can be stained or painted, just like a traditional timber fence

Structural Integrity

Pre-finished steel posts and rails prevents twisting and warping over time

Superior Acoustic Properties

Ideal for the reduction of noise beside busy roads and child care centres

Available colours for posts and rails

Black Thunder Slate Grey



For more inspiration, scan the QR code or visit <https://www.boundaryline.co.nz/inspiration/>

Horizontal



Driveway Gates

Double swing or sliding gate configurations custom manufactured on request



Vertical

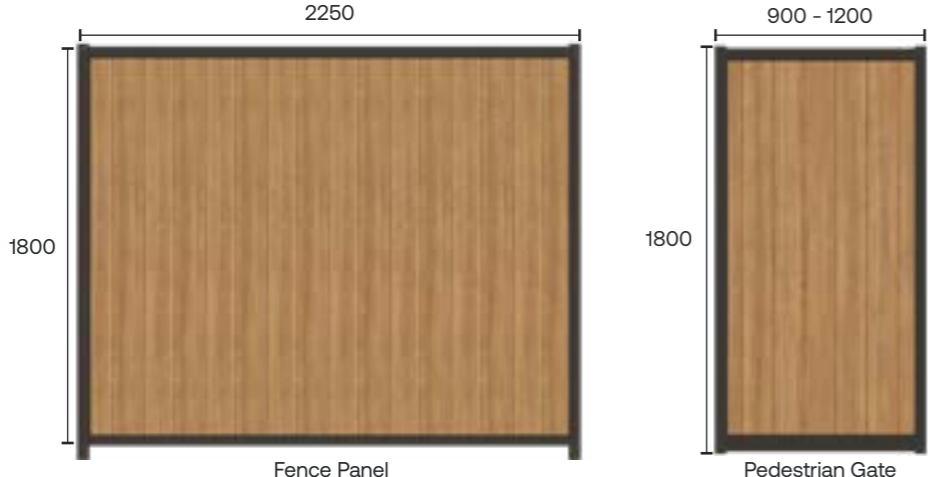

Acoustic Properties

The acoustic properties of SmartWall makes it the ideal choice for medium density housing, childcare centres and homes located near busy roads. Visit boundaryline.co.nz to download SmartWall acoustic performance report.

CLT palings

Cross Laminated Timber (CLT) palings are a cross laminated timber plank developed using high performance European glue lamination technology.

The gluing of three layers of timber, with the middle layer the opposite orientation to the outer layers, provides maximum stability and strength, reducing the twisting and warping that is common in traditional timber fencing.

Mini CLT planks are treated using the environmentally preferable MicroPro timber treatment, which is GreenGuard certified for use in play areas and child care centres for children of all ages.



Slat Top

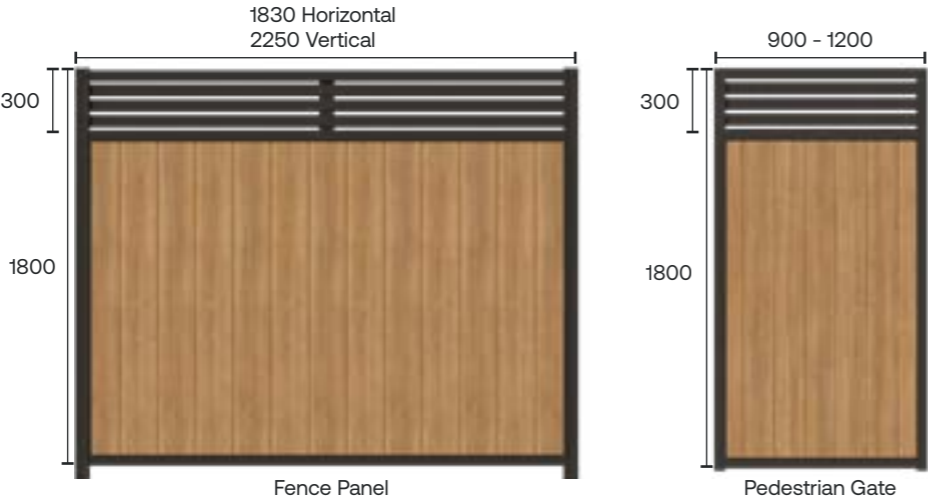

SmartWall Vertical | DuraPanel Polo



PICKETPANEL



PicketPanel Juno

Modern take on traditional fencing

PicketPanel embraces the nostalgia of the traditional picket fence, while providing a refined architectural range of contemporary options suited to the modern environment and today's busy lifestyle.

A durable interpretation of the symbolic family home boundary, blending the romance of days gone by with design and construction fit for the next generation.

Designed in consultation with industry partners to meet the needs of New Zealand's increase in medium density housing developments.



PicketPanel Forte

Atlas



Panel height — 950 / 1200 / 1500 / 1800mm
 Panel length — 2430mm
 Picket size — 50x16mm
 Picket spacing — 50mm
 Panel profile — Aluminium picket
 Post size — 50x50mm
 PicketPanel is F4 (Fall From Height) and F9 (Pool Fencing) compliant

Juno



Panel height — 950 / 1200 / 1500 / 1800mm
 Panel length — 2430mm
 Picket size — 70x16mm
 Picket spacing — 30mm
 Panel profile — Aluminium picket
 Post size — 65x65mm
 PicketPanel is F4 (Fall From Height) and F9 (Pool Fencing) compliant

Opus



Panel height — 950 / 1200 / 1500 / 1800mm
 Panel length — 2430mm
 Picket size — 50x16 & 70x16mm
 Picket spacing — 40 & 50mm
 Panel profile — Aluminium picket
 Post size — 50x50mm
 PicketPanel is F4 (Fall From Height) and F9 (Pool Fencing) compliant

Forte

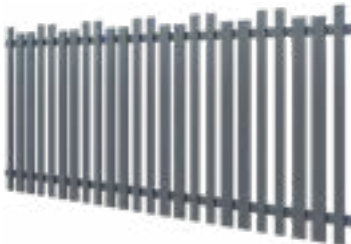

Panel height — 950 / 1200 / 1500 / 1800mm
 Panel length — 2430mm
 Picket size — 50x16 & 70x16mm
 Picket spacing — 30, 40 & 50mm
 Panel profile — Aluminium picket
 Post size — 50x50mm
 PicketPanel is F4 (Fall From Height) and F9 (Pool Fencing) compliant

Rondo



Panel height — 950 / 1200 / 1500 / 1800mm
 Panel length — 2430mm
 Picket size — 70x16mm
 Picket spacing — 30mm
 Panel profile — Aluminium picket
 Post size — 65x65mm
 PicketPanel is F4 (Fall From Height) and F9 (Pool Fencing) compliant

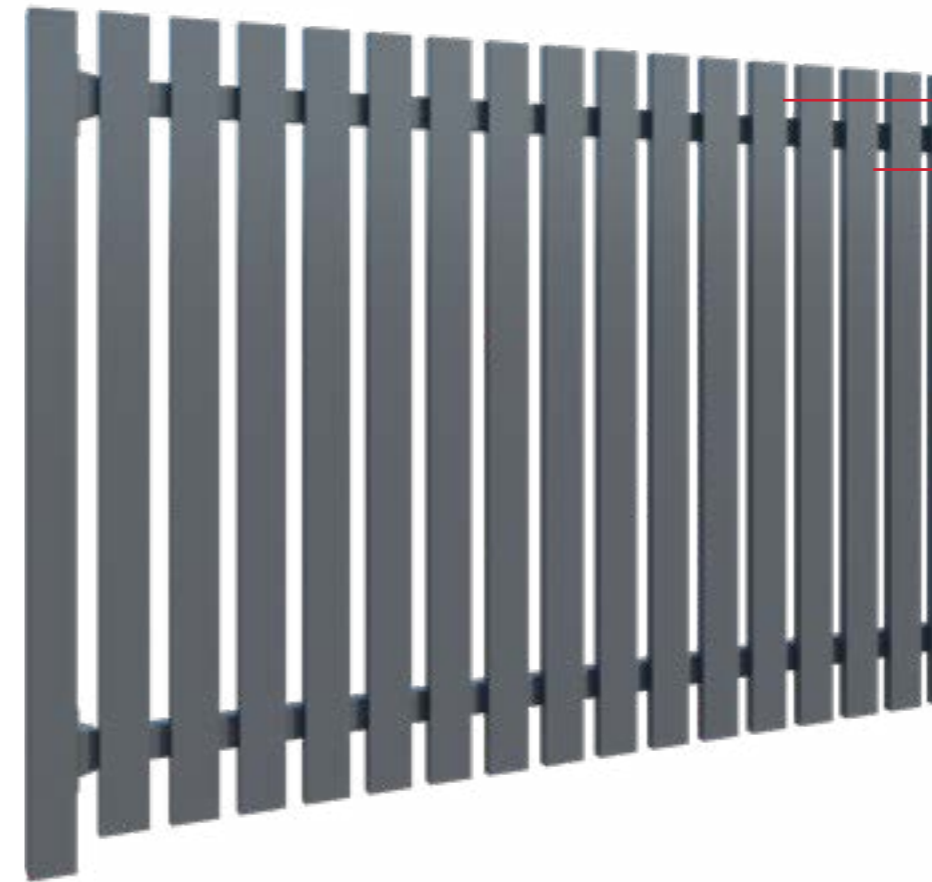

Traditional Style Pickets

Inspired by the traditional picket fence

Aluminium Construction

Strength, durability and low maintenance

Quick and Simple Installation

Modular system with screw on brackets

Raking Design

Rakes to meet slopes

Available colours

Black Frost



For more inspiration, scan the QR code or visit <https://www.boundaryline.co.nz/inspiration/>

PICKETPANEL

Technical Drawings

Atlas

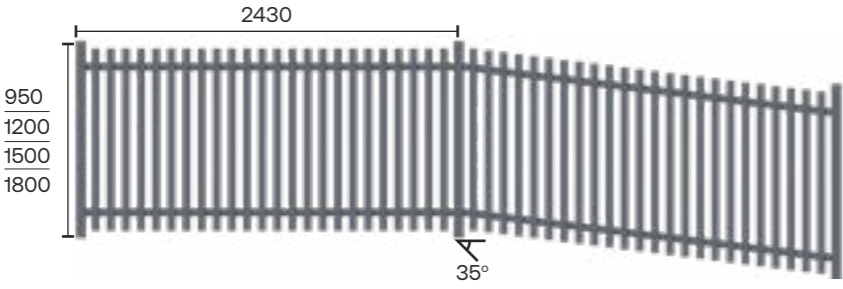

Juno

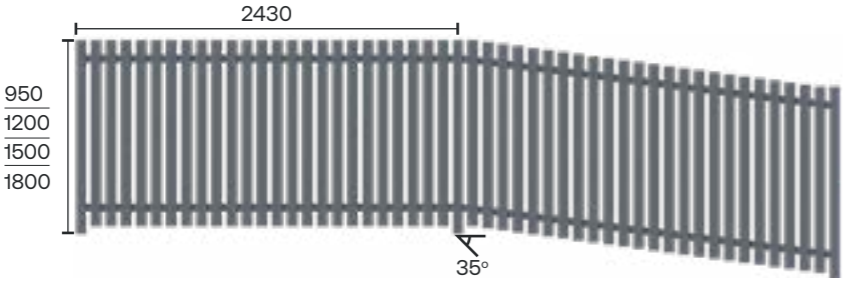

Opus

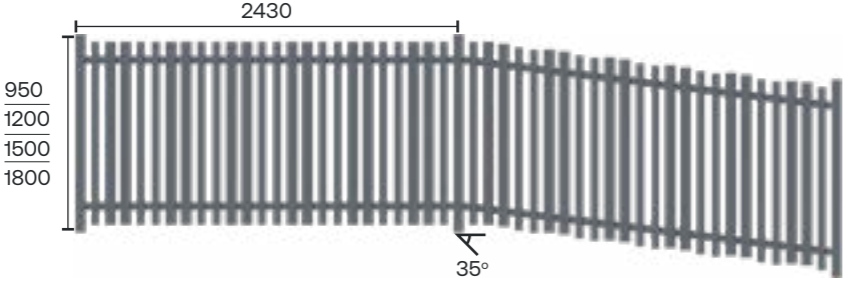

Forte

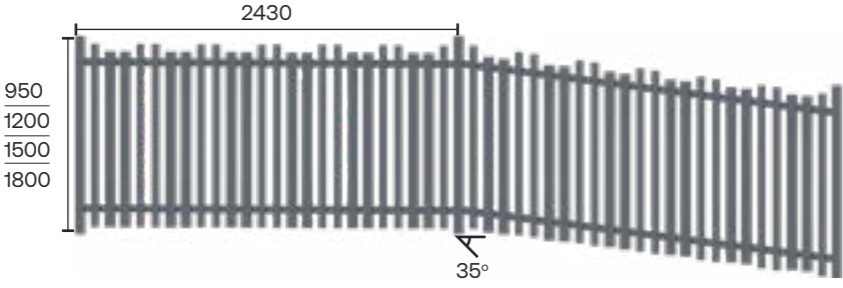

Rondo

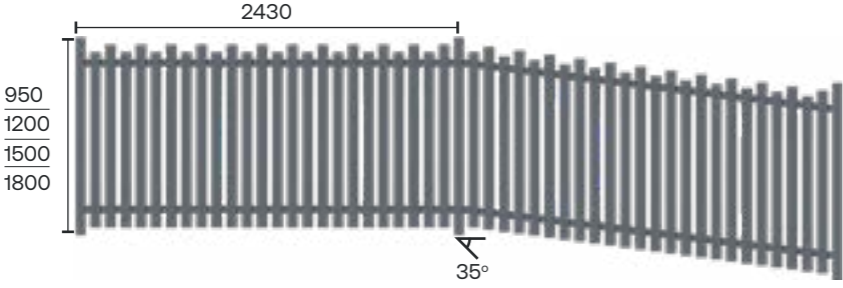

Raking Panels

The unique design of PicketPanel allows for panels to be installed on any angle up to 35 degrees to suit ground contours. This allows panels to be installed on undulating & sloping ground while meeting the maximum gap requirements for fencing installed in F4 (Fall from Height) and F9 (Pool Fencing) situations.





COLOURPANEL



ColourPanel Classic

Setting the standard in residential fencing

For great looking, low maintenance privacy fencing, Boundaryline ColourPanel sets the standard throughout New Zealand. No more twisted or rotten timber fences.

ColourPanel is truly a same-both-sides fence, which makes it ideal for urban properties since both neighbours get the 'good' side of the fence.

ColourPanel is made from a prefinished steel commonly used for roofing which is durable and stable. It will not warp and twist like a traditional timber fence, even when a dark colour is used in any climate.

Installation is very quick and simple, with modular, colour matched components. Even DIY customers will be impressed with how easy it is to get the job done!

To maintain the same look as the day it was installed, all ColourPanel needs is the occasional wash down. No painting or staining required.



ColourPanel Classic



ColourPanel Slat Top

Classic



Panel height — 1200 / 1500 / 1800 / 2100mm
 Post centres — 2380mm
 Panel profile — Reflect panel
 Post size — 65x65mm

Slat top



Panel height — 1200 / 1500 / 1800 / 2100mm
 Post centres — 2380mm
 Panel profile — Reflect panel with 300mm slat panel
 Post size — 65x65mm

Pedestrian Gate



Gate height — 1200 / 1500 / 1800mm
 Gate width — 870mm
 Panel profile — Reflect panel

Kitset includes 2x gate stiles, 1x reflect sheet, 1x rail, tek screws and standard gate hardware



Pre-Finished Components

All parts are colour matched

High Quality

Powder coated finish.
Standard in black

Quick & Simple Installation

Cost effective modular system

Ultra Low Maintenance

The fence that never needs painting or staining

Same Both Sides

Both neighbours get the 'good' side of the fence

Complete Privacy

No gaps in the panels

Available colours

Black Thunder Slate Grey Frost



For more inspiration, scan the QR code or visit <https://www.boundaryline.co.nz/inspiration/>

COLOURPANEL

Technical Drawings

Classic

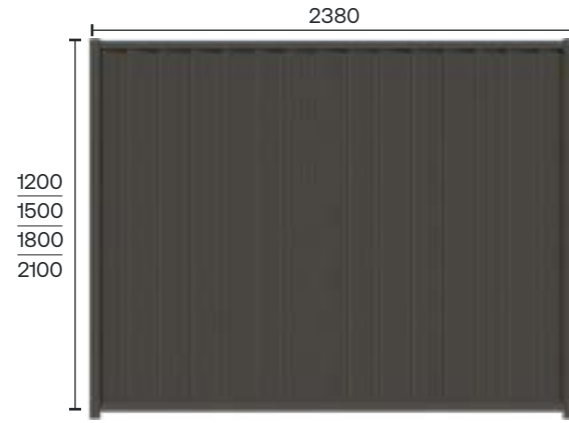

Slat Top

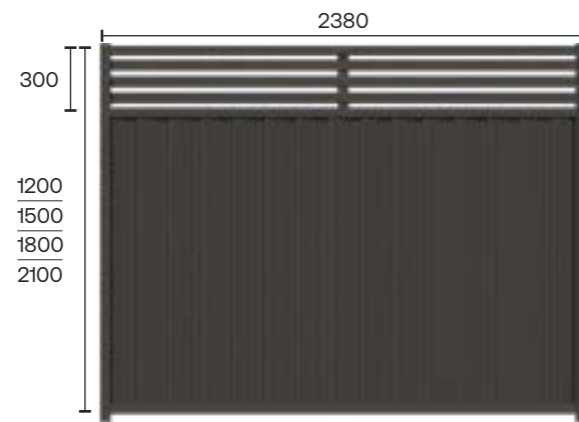

Gates

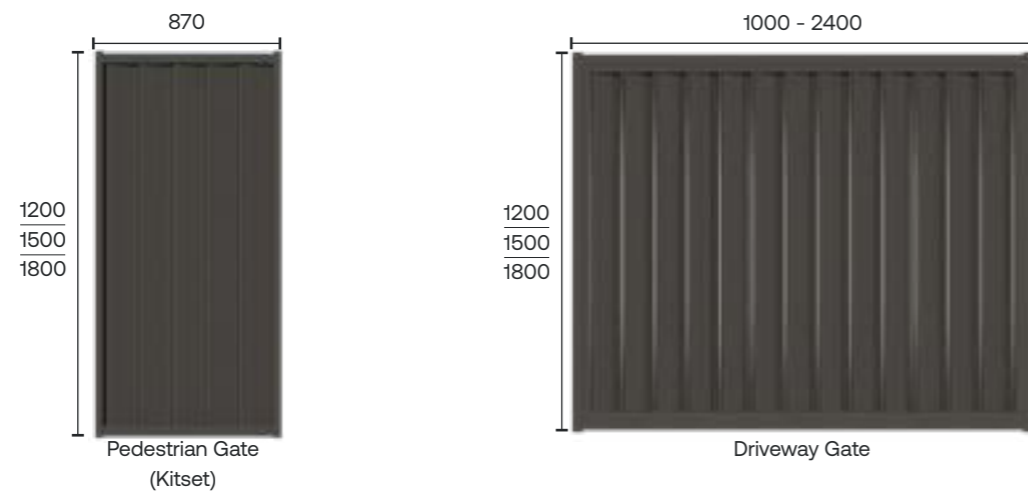

Integration Options

The ColourPanel C-post and rail system allows for seamless integration of ColourSlat fencing within any fenceline allowing permeable slat panels to be integrated with solid panels.



SmartWall also utilises the same C-post and rail system and is another integration option.





COLOURSLAT



ColourSlat Steel

Smart integrated privacy screening

Boundaryline ColourSlat is the ideal choice for screening outdoor living areas and courtyards, as it allows natural light penetration while providing privacy.

For long term durability and a great appearance, choose the standard steel ColourSlat. This is a complete system using prefinished steel components and will not fade, warp or twist.

If you are looking for an alternative to an all steel fence, ColourSlat with timber slats will meet your requirements. The timber slats are manufactured from high grade Radiata Pine and can be stained to the colour of your choice.

ColourSlat is designed to seamlessly integrate with ColourPanel fencing, or it can be installed as a stand-alone fencing system.



ColourSlat Timber



ColourSlat Steel

Steel



Panel height — 1200 / 1500 / 1800mm
Panel length — 2380mm
Slat size — 55x7.5mm
Slat spacing — 25mm
Panel profile — Steel slat
Post size — 65x65mm

Timber



Panel height — 1200 / 1500 / 1800mm
Panel length — 2380mm
Slat size — 70x12mm
Slat spacing — 11mm
Panel profile — Timber slat, Radiata Pine H3
Post size — 65x65mm



Ideal For Screening

Provides privacy without being closed in

Pre-Finished Components

All steel parts are colour matched

Long Term Durability

Quick & Simple Installation

All modular components and minimal site disturbance

Modular Components

Can be integrated with ColourPanel



ColourSlat Steel



ColourSlat Steel



ColourSlat Timber

For more inspiration, scan the QR code or visit <https://www.boundaryline.co.nz/inspiration/>

Steel

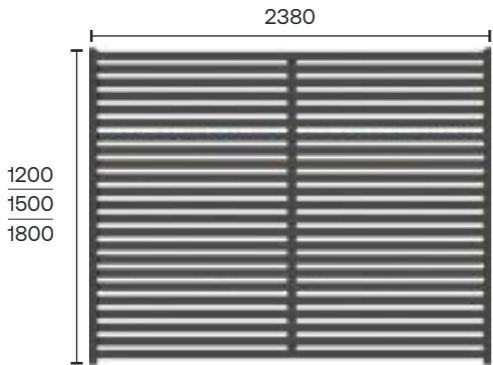

Timber

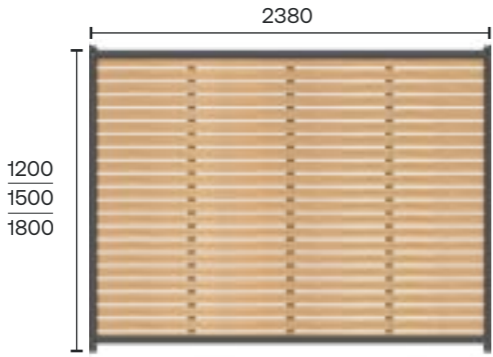

Steel Gate

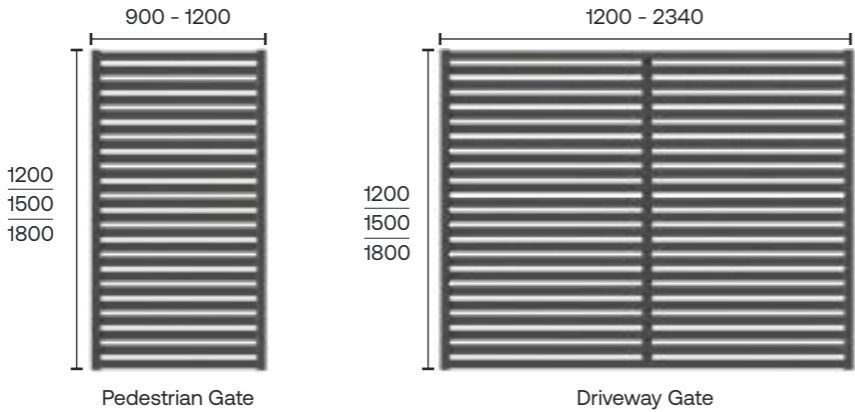

Timber Gate

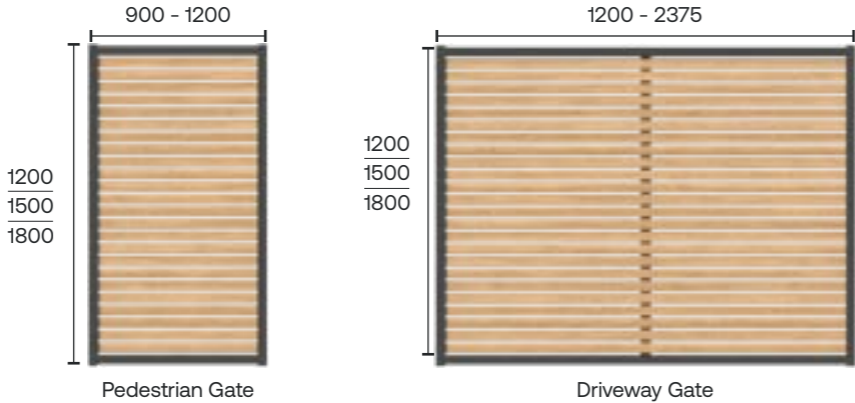

Integration Options

The ColourSlat C-post and rail system allows for seamless integration of ColourPanel fencing within any fenceline allowing permeable slat panels to be integrated with solid panels.



SmartWall also utilises the same C-post and rail system and is another integration option.





ASCOT GATES



Regent

Smart and easy pedestrian gates

Ascot Gates are manufactured from New Zealand grown Radiata Pine, pressure treated H3 for maximum durability and constructed using traditional mortise and tenon methodology to ensure robustness and reliability.

Available in four popular designs, these robust and reliable timber gates will complement any home. They are available in both standard and custom heights and widths to suit specific project requirements.



Oxford

ASCOT GATES

Design Options



Oxford

Pedestrian

Gate height — 1200 / 1500 / 1800mm
Gate width — 900 - 1200mm
Gate frame — 70x45mm
Construction — Mortise & tenon joints
Timber — Radiata Pine H3.2 treated

Driveway

Gate height — 1200 / 1500 / 1800mm
Gate width — 1200 - 2000mm
Gate frame — 70x45mm
Construction — Mortise & tenon joints
Timber — Radiata Pine H3.2 treated



Belmont

Pedestrian

Gate height — 1200 / 1500 / 1800mm
Gate width — 900 - 1200mm
Gate frame — 70x45mm
Construction — Mortise & tenon joints
Timber — Radiata Pine H3.2 treated

Driveway

Gate height — 1200 / 1500 / 1800mm
Gate width — 1200 - 2000mm
Gate frame — 70x45mm
Construction — Mortise & tenon joints
Timber — Radiata Pine H3.2 treated

Regent

Pedestrian

Gate height — 1200 / 1500 / 1800mm
Gate width — 900 - 1200mm
Gate frame — 70x45mm
Construction — Mortise & tenon joints
Timber — Radiata Pine H3.2 treated

Driveway

Gate height — 1200 / 1500 / 1800mm
Gate width — 1200 - 2000mm
Gate frame — 70x45mm
Construction — Mortise & tenon joints
Timber — Radiata Pine H3.2 treated



Harrow

Pedestrian

Gate height — 1200 / 1500 / 1800mm
Gate width — 900 - 1200mm
Gate frame — 70x45mm
Construction — Mortise & tenon joints
Timber — Radiata Pine H3.2 treated

Driveway

Gate height — 1200 / 1500 / 1800mm
Gate width — 1200 - 2000mm
Gate frame — 70x45mm
Construction — Mortise & tenon joints
Timber — Radiata Pine H3.2 treated





ELITEWALL



EliteWall Classic

New Zealand's premium panel fence

The EliteWall system is the preferred choice for property owners who require a cost effective solid panel fence that provides style, function and privacy.



EliteWall Classic

EliteWall is New Zealand's most advanced line of modular panel fencing. Made with lightweight components, yet structurally strong and simple to install.

Superior acoustic performance makes EliteWall a popular option for rest homes and motels, or any property located near busy roads.

EliteWall is the ideal alternative to concrete or block walls at a fraction of the cost and is suitable for fencing in earthquake zones.



EliteWall with Louvres

A complete range of infill options gives the flexibility to choose any combination of panels between posts; solid panels, DuraPanel infill, Green Screen infill and aluminium slats or louvres. EliteWall has an extensive range of different design possibilities.

Classic



Fence height — 900 - 2100mm
 Panel thickness — 50mm
 Posts — 180x120mm
 Post centres — 2530 / 2830mm

Signature



Fence height — 900 - 2100mm
 Panel thickness — 70mm
 Posts — 280x140mm
 Post centres — 2630 / 2930mm

Estate



Fence height — 900 - 2100mm
 Panel thickness — 70mm
 Posts — 320x210mm
 Post centres — 2670 / 2970mm

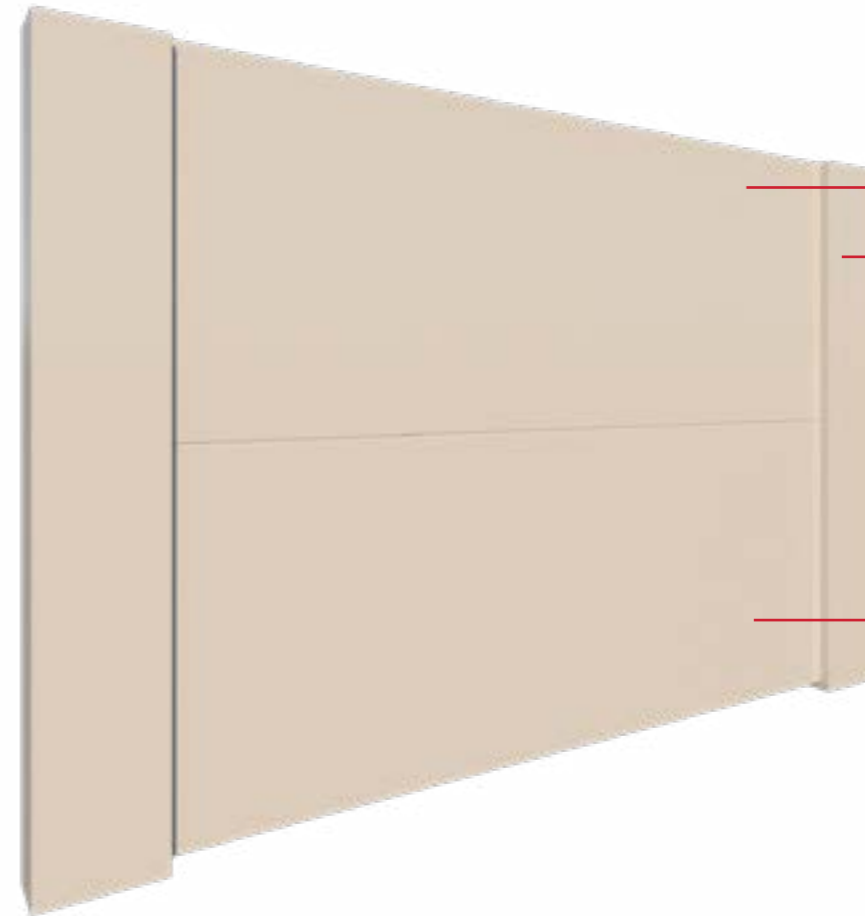

Superior Acoustic Properties

Great for properties beside a busy road

Cost Effective Privacy

Solid fencing at a much lower cost than concrete

No Masonry to Crack

Allows for ground movement and works well in earthquake zones

Quick & Simple Installation

All modular components and minimal site disturbance

Finishing Options

EliteWall requires painting after installation, can be flat painted, spray-textured or plastered



For more inspiration, scan the QR code or visit <https://www.boundaryline.co.nz/inspiration/>

ELITEWALL

Infill Options



Louvres

Aluminium louvre infills provide privacy and security with an upmarket, contrasting design aesthetic. Aluminium louvres are supplied with a powder coated finish and can be colour matched to any standard New Zealand colour.

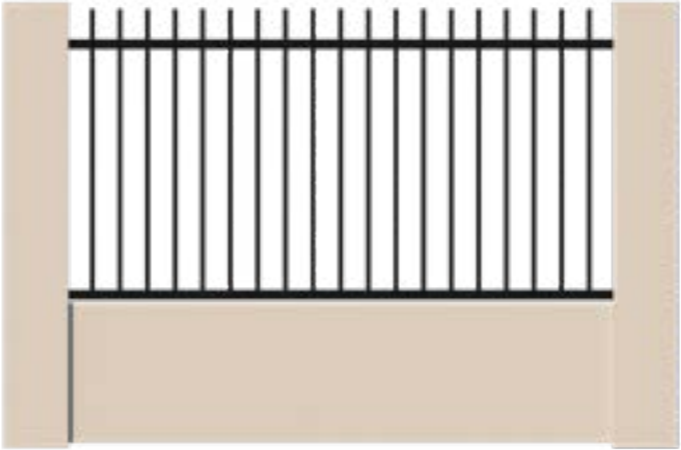

DuraPanel Infill

DuraPanel infill option is great solution where sections of fenceline require a more open permeability. DuraPanel is supplied standard in black powder coated finish, but also can be colour matched to any standard New Zealand colour.

Slats

Aluminium slats provide an open feel, while maintaining a level of privacy for the property owner. Aluminium slats are supplied in a powder coated finish and can be colour matched to any standard New Zealand colour.



Green Screen Infill

Green Screen infill option provides a unique mesh design element to encourage the growth of climbers and plants.

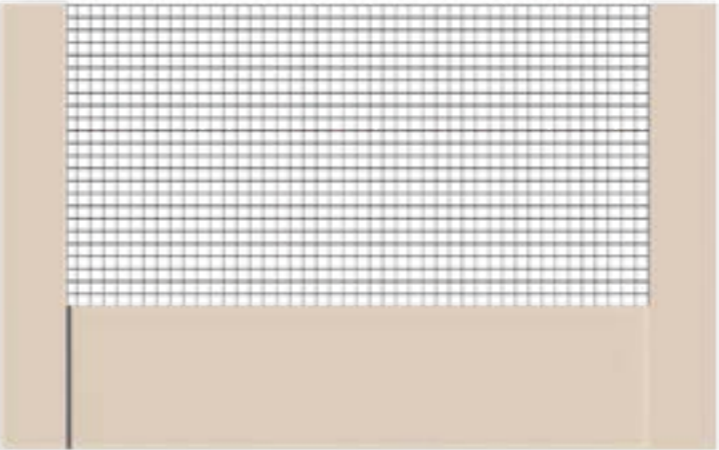

Finishing Solutions



Traditional



Suburban

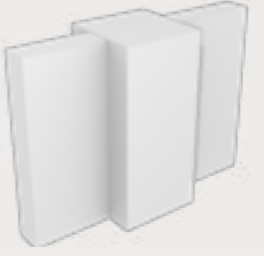

Contemporary

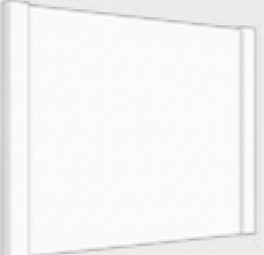

Closed panel joint
For a clean, refined joint detail



Negative detail joint
Enhance the look by utilising the panel join for a horizontal detail





GREEN SCREEN



Green Screen

Green fencing made easy

Green Screen is a unique mesh fence panel that is designed to support climbers and plants. Green Screen provides an initial security and barrier as a modular fence system, while the unique integrated mesh design encourages growth of climbers and provides maximum support for the most delicate plants.

Over time the fence will form a dense and uniform green wall that blends in with nature and enhances the landscape. Green Screen is a practical and great looking landscape feature for any property.

Green Screen is a component based system and easy to install between the standard slim line posts, or any column design of your choice.



Green Screen

GREEN SCREEN

Design Options

Design Features

Horizontal

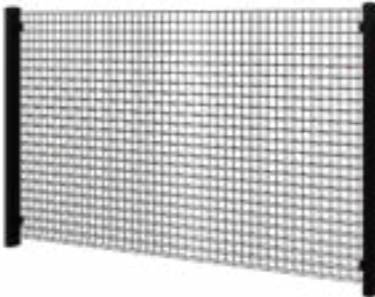

Panel height — 1220mm
 Panel length — 2233mm
 Panel thickness — 50mm
 Aperture — 50x50mm
 Finish — Powder coated
 Post size — 50x50mm

Vertical



Panel height — 2233mm
 Panel length — 1220mm
 Panel thickness — 50mm
 Aperture — 50x50mm
 Finish — Powder coated
 Post size — 50x50mm

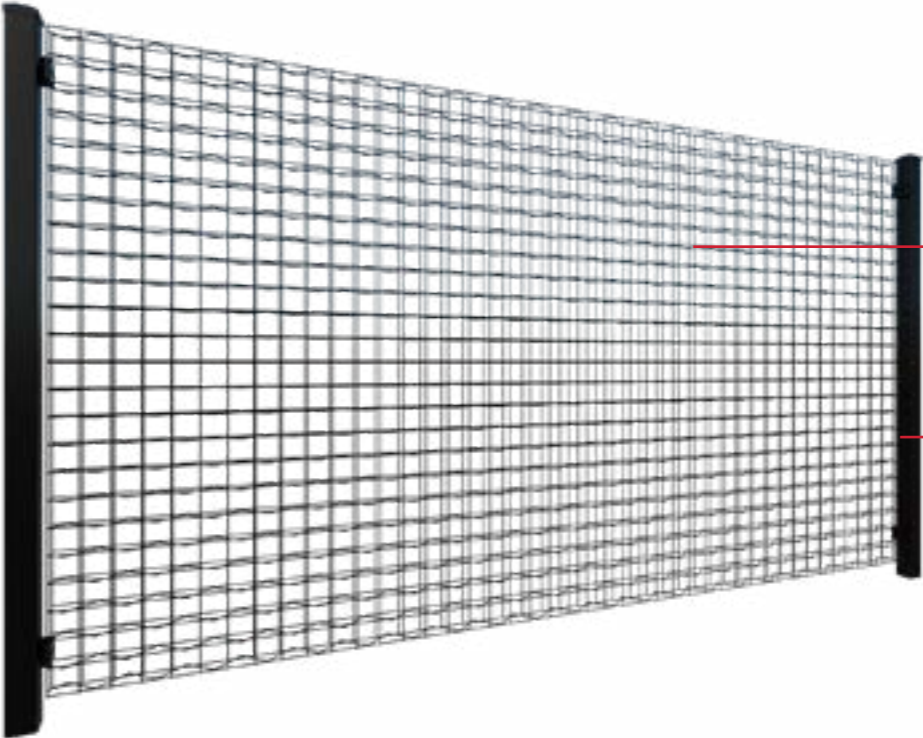

The Living Fence

Designed to enable the growth of climbers

Quick & Simple Installation

All modular components to make installation easy

Modular System

Can be integrated with other fencing systems

Feature Fencing

Makes your fencing a standout feature in your landscape



Green Screen



Green Screen with EliteWall



Green Screen

For more inspiration, scan the QR code or visit <https://www.boundaryline.co.nz/inspiration/>



POST&RAIL



Post&Rail 3-Rail

New Zealand's versatile fence

From lifestyle blocks to large farms, entrance ways to subdivision projects, Boundaryline's Post&Rail is used all over New Zealand and in a variety applications.

Post&Rail is a cost effective and easy way to enhance the appearance of your property.

The unique Boundaryline straight through mortise allows the rails to interlock in the post without the use of any hardware. This makes for a strong fence that is simple to install, even on sloping ground and with curved lines.

We use specially selected premium grade timber to ensure our Post&Rail fencing looks great for years to come.

With a wide range of options and the ability to supply custom made systems, we can provide a Post&Rail solution to suit your design requirements.



Post&Rail 2-Rail

2-Rail

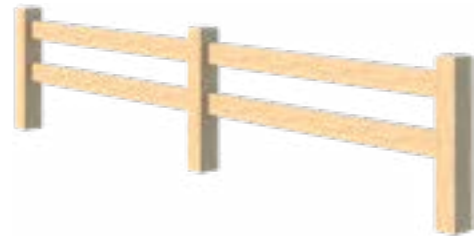

Post size ————— 125x125 / 150x150 / 200x200mm
 Height out of ground — 950 - 1050mm
 Rail Length ————— 2100 / 2400mm

3-Rail

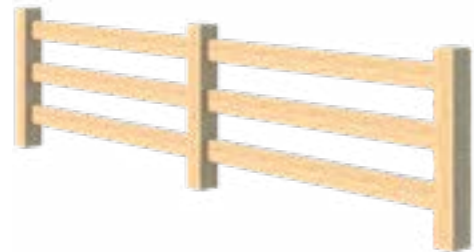

Post size ————— 125x125 / 150x150 / 200x200mm
 Height out of ground — 1100 - 1200mm
 Rail Length ————— 2100 / 2400mm

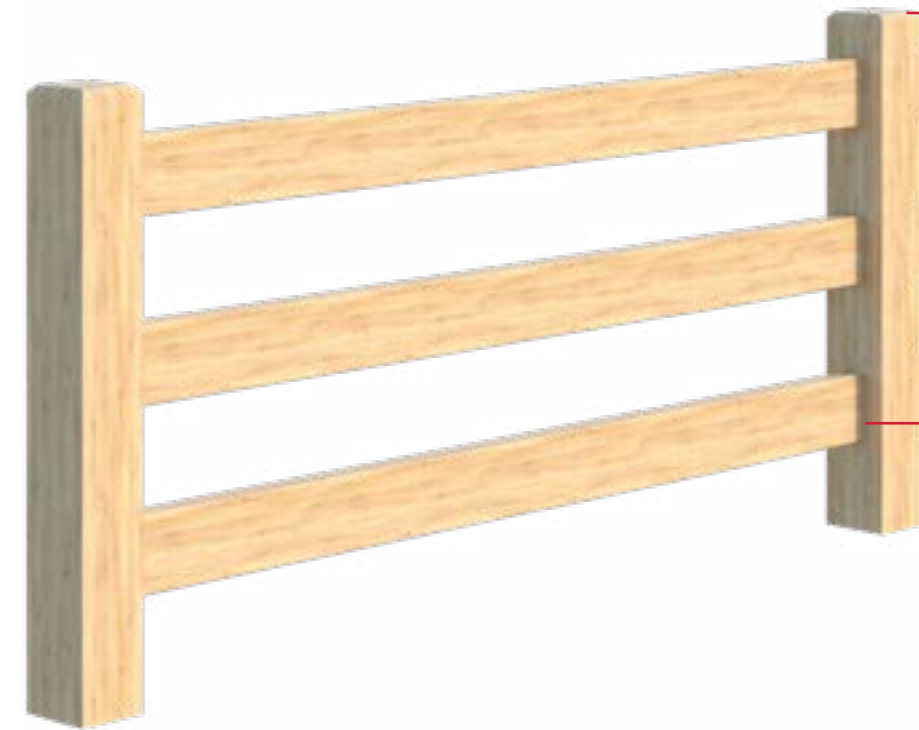

Selected Premium Grade Timber

Superior landscaping timber. Selected to avoid twisting and splitting

Chamfered Post Tops

For a neat and tidy look

Pine or Macrocarpa

Treated Radiata Pine for guaranteed durability, or chemical free, naturally durable Macrocarpa

Straight Through Mortise

Strong and durable, easy to install and no bulky brackets

Custom Design

Available as a standard two rail or three rail system, or work with us to create a custom design for your property



For more inspiration, scan the QR code or visit <https://www.boundaryline.co.nz/inspiration/>



LIFESTYLE TIMBER GATES



Oakfield



Sheffield

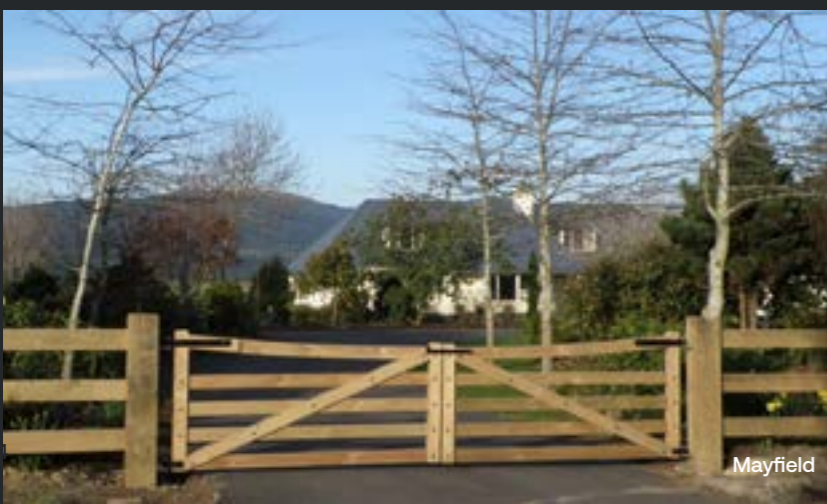

Mayfield

Boundaryline's Lifestyle Timber Gates stand out from the crowd. Made in a traditional style to match our Post&Rail fencing, these are not your average farm gates.

With a focus on manufacturing quality, these classic timber gates have thicker rails for added strength, dressed timber for a sleek finish and supplied with black powder coated hardware and hinges to complete the look.

Gate Features

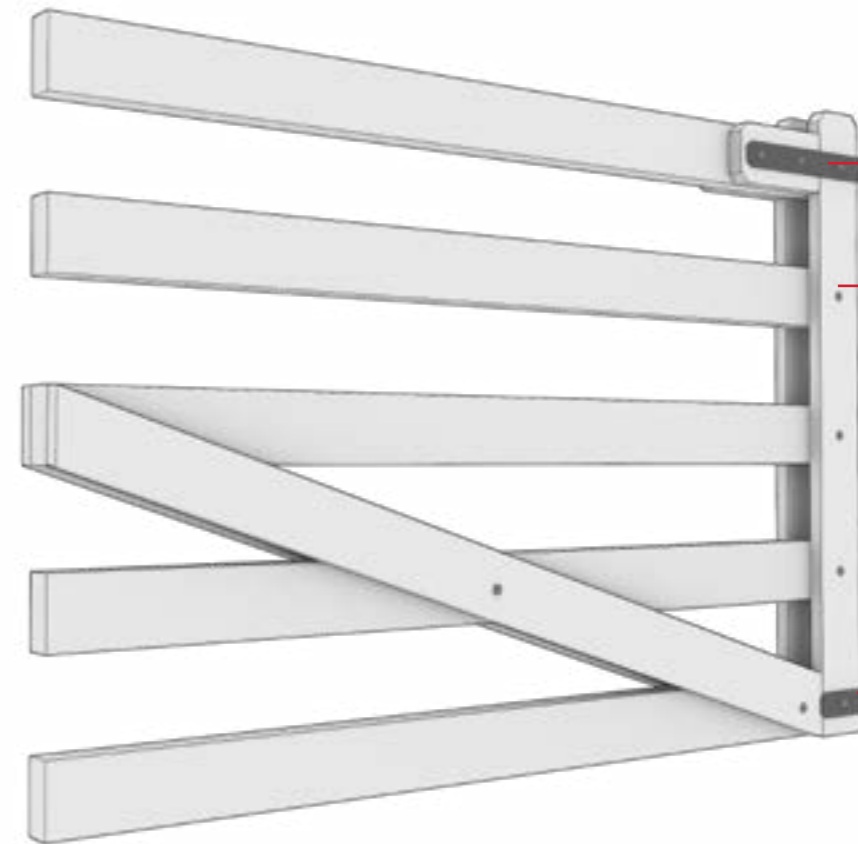

Wrap Around Strap Hinges

For strength and durability

Dressed Timber

For a refined appearance

Bolted Construction

All joints are fixed with black bolts for strength

Black Hardware & Latches

For a premium look

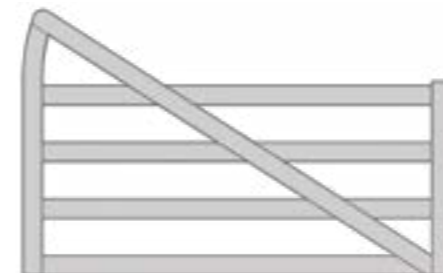

Oakfield

- Height — 900 / 1000 / 1200mm
- Length — 1000 / 1800 / 2100 / 2400 / 2700 / 3000mm
Custom length can be made to order
- Rail size — 90x32mm
- Timber — Radiata Pine H3 or Macrocarpa

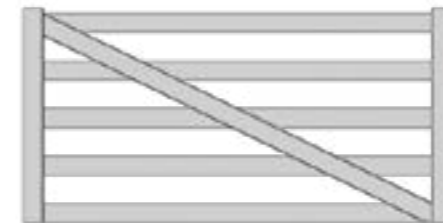

Sheffield

- Height — 900 / 1000 / 1200mm
- Length — 1000 / 1800 / 2100 / 2400 / 2700 / 3000mm
Custom length can be made to order
- Rail size — 90x32mm
- Timber — Radiata Pine H3 or Macrocarpa

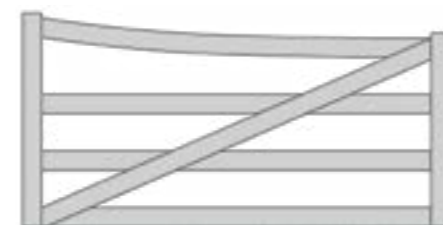

Mayfield

- Height — 900 / 1000 / 1200mm
- Length — 1000 / 1800 / 2100 / 2400 / 2700 / 3000mm
Custom length can be made to order
- Rail size — 90x32mm
- Timber — Radiata Pine H3 or Macrocarpa



TIMBER BOLLARDS



Angle Top with Collar

Boundaryline bollards are the ideal cost effective way to block vehicle access to parks, reserves and walkways, while allowing easy entry for pedestrians and cyclists.

Boundaryline bollards are made to our standard designs or to your own specification.

We use premium landscape grade timbers: Radiata Pine and Macrocarpa. Or, if required, a selection of sustainable hardwoods are available.

We manufacture custom designed bollards including metalwork features and signage if required. Speak to us to make your ideas become reality.



Custom Angle Top

Bollard Solutions

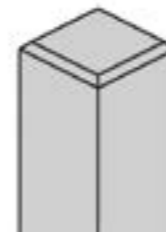

Square top

Post Size ————— 125x125 / 150x150 / 200x200mm
Length ————— 900 / 1200 / 1500 / 1800mm
Timber ————— Radiata Pine H4 or Macrocarpa

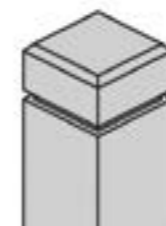

Square top with collar

Post Size ————— 125x125 / 150x150 / 200x200mm
Length ————— 900 / 1200 / 1500 / 1800mm
Timber ————— Radiata Pine H4 or Macrocarpa

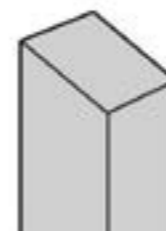

Angle top

Post Size ————— 125x125 / 150x150 / 200x200mm
Length ————— 900 / 1200 / 1500 / 1800mm
Timber ————— Radiata Pine H4 or Macrocarpa

Custom designs available, contact us to discuss custom solutions

CUSTOM ENTRANCE GATES

Enhance and secure
your property



Gates and entrance ways are an important component of landscape design and are essential to secure and enhance any property.

Boundaryline can provide custom gates for all kinds of projects and many of these are taken care of by the Heritage team.

Heritage Gates & Fences is an associate brand of Boundaryline, with over 25 years of experience in manufacturing custom gate and fence solutions.

Heritage Gates & Fences started out manufacturing wooden gates but now focus on producing traditional-style gates in aluminium to achieve the same look but with low maintenance and long term durability.

The range also includes open-style gates and contemporary designs along with the ability to produce gates to a custom design.



Heritage Wisconsin



Heritage Kansas



Heritage Kingston



DuraPanel Delta



SmartWall Vertical | DuraPanel Polo



Post&Rail 3-Rail



DuraPanel Axis



DuraPanel Axis



DuraPanel Titan

1. © Copyright August 2023. All rights reserved. No part of this publication may be reproduced in any form without written permission of Terranota Ltd.
2. The purpose of this catalogue is to showcase the Boundaryline range of fencing and gate solutions available from Terranota Ltd. While Terranota Ltd has made every effort to portray accurate descriptions and information within this catalogue, Terranota Ltd cannot accept any responsibility for specifications or completed work based on information in this catalogue. In all construction projects, care must be taken to comply with all relevant statutory requirements and recommended codes of practice. The customer or user must establish the suitability of any product purchased for their own safe use.
3. Terranota Ltd reserves the right to update or change any specifications in this catalogue without prior notice. Products may be deleted, amended, substituted or changed at the sole discretion of Terranota Ltd.
4. Trademarks: Terranota, Boundaryline, DuraPanel, ColourPanel, SentryPanel, ColourSlat, SleekWall, SmartWall, PicketPanel & EliteWall trademarks of Terranota Ltd, some of which are registered trademarks. Terranota Ltd will not hesitate to take legal action to protect the company's proprietary rights in this regard.
5. Any measurements shown are intended as a guide only. Please confirm any critical measurement with Terranota Ltd.



Auckland

43 Noel Burnside Road
09 250 1144

Christchurch

22 Islington Avenue
03 347 3191

Invercargill

60 Bastian Street
03 211 5145

0800 003 006

enquiries@boundaryline.co.nz

boundaryline.co.nz