



ETA-Danmark A/S
Göteborg Plads 1
DK-2150 Nordhavn
Tel. +45 72 24 59 00
Fax +45 72 24 59 04
Internet www.etadanmark.dk

Authorised and notified according
to Article 29 of the Regulation (EU)
No 305/2011 of the European
Parliament and of the Council of 9
March 2011

MEMBER OF EOTA



European Technical Assessment ETA-19/0765 of 2019/11/28

I General Part

Technical Assessment Body issuing the ETA and designated according to Article 29 of the Regulation (EU) No 305/2011: ETA-Danmark A/S

Trade name of the construction product:

VT-HP injection system

Product family to which the above construction product belongs:

Injection system for use in masonry

Manufacturer:

Simpson Strong-Tie®
Rue du Camp
Z.A.C. des Quatre Chemins
F-85400 Sainte Gemme La Plaine
Tel. +33 2 51 28 44 00
Fax +33 2 51 28 44 01
Internet www.simpson.fr

Manufacturing plant:

Simpson Strong-Tie®
Manufacturing facilities

This European Technical Assessment contains:

62 pages including 57 annexes which form an integral part of the document

This European Technical Assessment is issued in accordance with Regulation (EU) No 305/2011, on the basis of:

EAD 330076-00-0604, Metal injection anchors for use in masonry

This version replaces:

Translations of this European Technical Assessment in other languages shall fully correspond to the original issued document and should be identified as such.

Communication of this European Technical Assessment, including transmission by electronic means, shall be in full (except the confidential Annexes referred to above). However, partial reproduction may be made, with the written consent of the issuing Technical Assessment Body. Any partial reproduction has to be identified as such.

II SPECIFIC PART OF THE EUROPEAN TECHNICAL ASSESSMENT

1 Technical description of product and intended use

Technical description of the product

The VT-HP injection system is a bonded anchor (injection type) for concrete is a bonded anchor consisting of a mortar cartridge with VT-HP injection mortar a perforated nylon sleeve, and an anchor rod with hexagon nut and washer. The steel elements are made of zinc coated steel or stainless steel

The product specification is given in annex A.

The steel element is placed into a drilled hole filled with injection mortar and is anchored via the bond between metal part, injection mortar and masonry.

The characteristic material values, dimensions and tolerances of the anchors not indicated in Annexes shall correspond to the respective values laid down in the technical documentation¹ of this European Technical Assessment.

2 Specification of the intended use in accordance with the applicable EAD

The performances given in Section 3 are only valid if the anchor is used in compliance with the specifications and conditions given in Annex B.

The provisions made in this European Technical Assessment are based on an assumed intended working life of the anchor of 50 years.

The indications given on the working life cannot be interpreted as a guarantee given by the producer or Assessment Body, but are to be regarded only as a means for choosing the right products in relation to the expected economically reasonable working life of the works.

¹ The technical documentation of this European Technical Assessment is deposited at ETA-Danmark and, as far as relevant for the tasks of the Notified bodies involved in the attestation of conformity procedure, is handed over to the notified bodies.

3 Performance of the product and references to the methods used for its assessment

3.1 Characteristics of product

Mechanical resistance and stability (BWR 1):

The essential characteristics are detailed in the Annex C.

Safety in case of fire (BWR 2):

Reaction to fire: The anchor connections satisfy requirements for Class A1.

Resistance to fire. No performance assessed.

Hygiene, health and the environment (BWR3):

No performance assessed

Safety in use (BWR4):

For basic requirement Safety in use the same criteria are valid for Basic Requirement Mechanical resistance and stability (BWR1).

Sustainable use of natural resources (BWR7)

No performance determined

Other Basic Requirements are not relevant.

3.2 Methods of assessment

The assessment of fitness of the anchor for the intended use in relation to the requirements for mechanical resistance and stability and safety in use in the sense of the Basic Requirements 1 and 4 has been made in accordance with EAD 330076-00-0604, Metal injection anchors for use in masonry.

4 Assessment and verification of constancy of performance (AVCP)

4.1 AVCP system

According to the decision 1997/177/EC of the European Commission, the system(s) of assessment and verification of constancy of performance (see Annex V to Regulation (EU) No 305/2011) is 1.

5 Technical details necessary for the implementation of the AVCP system, as foreseen in the applicable EAD

Technical details necessary for the implementation of the AVCP system are laid down in the control plan deposited at ETA-Danmark prior to CE marking.

Issued in Copenhagen on 2019-11-28 by



Thomas Bruun
Managing Director, ETA-Danmark

Anchor application in solid masonry

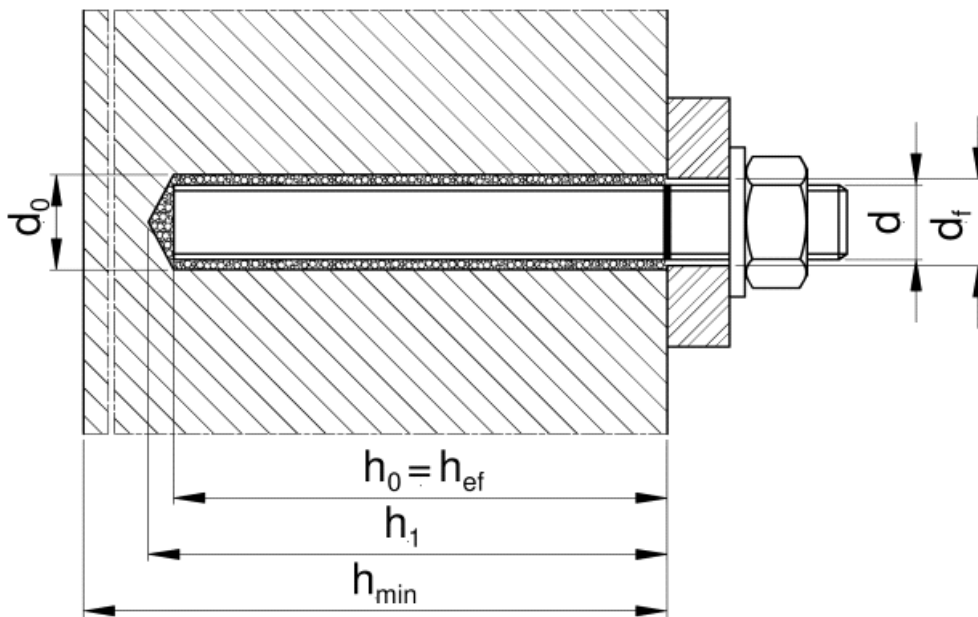

Anchor application in hollow/perforated masonry with nylon sleeve

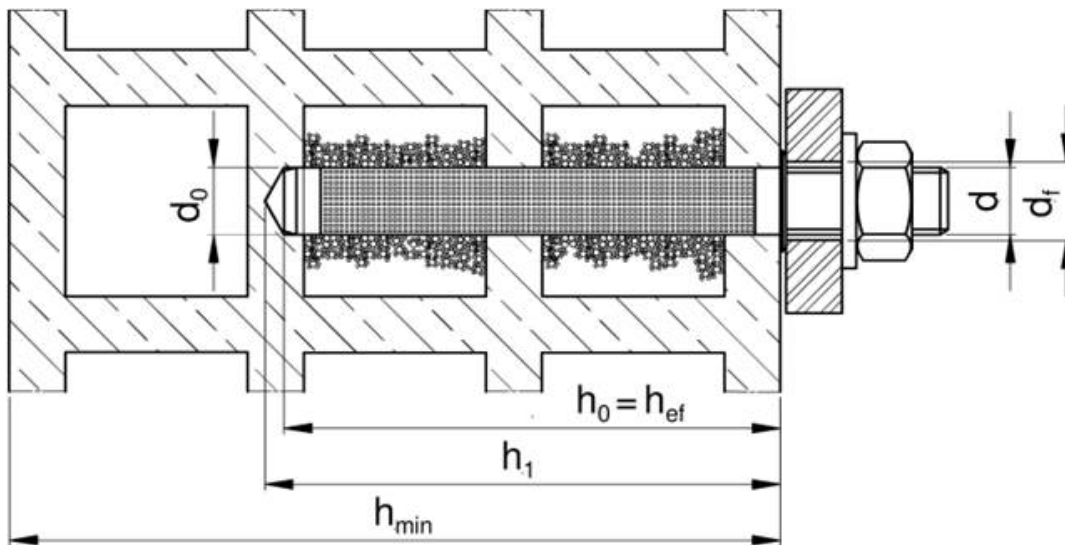

- d = diameter of the threaded rod
- d_0 = diameter of drill bit
- d_f = diameter of clearance hole in the fixture
- h_{ef} = effective anchorage depth
- h_{min} = minimum thickness of the base material
- h_1 = depth of drilled hole to deepest point

Injection System VT-HP® for masonry

Product description
Installed condition

Annex A1

Cartridge: VT-HP®

- A) Foil Bag Cartridge 165ml, 300ml.**
- B) Coaxial Cartridge 380ml / 400 ml / 410 ml / 420ml**
- C) Side by Side Cartridge 345ml, 825ml**

Cartridge Print : VT-HP®

Including - Installation procedure,
Production Batch code, Expiry Date,
Storage conditions, Health & Safety
warning, Gel & Cure time according to
temperatures.



A)



B)

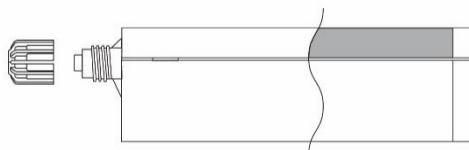

C)

Marking:

VT-HP®

Batch code, either expiry date or manufacturing date with shelf life

Mixer with hanger

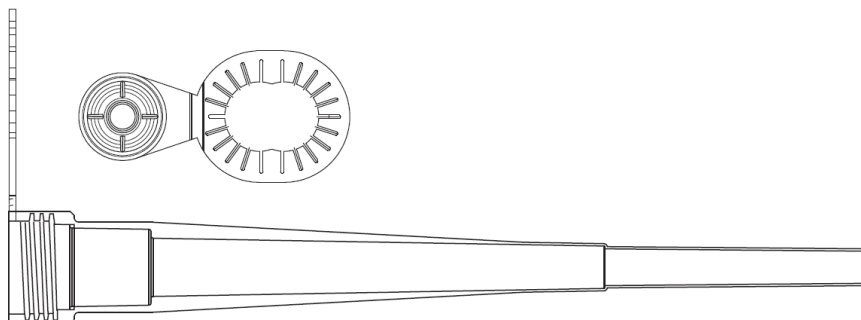

Mixer

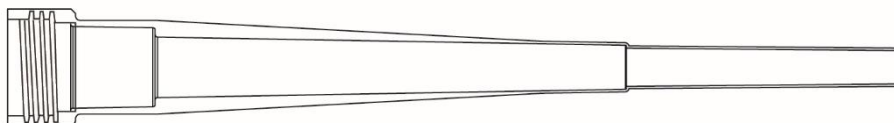

Injection System VT-HP® for masonry

Product description
Injection system

Annex A2

Threaded rod M8, M10, M12, M16

Flat tip

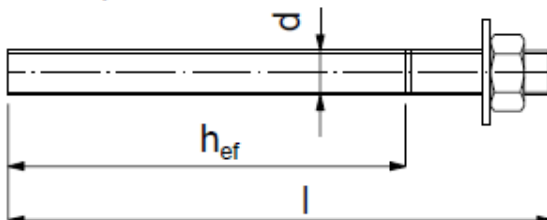

One side 45 chamfer

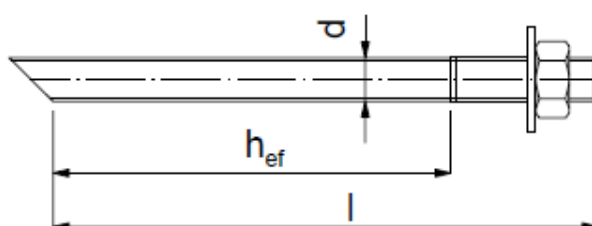

Two sides 45 chamfer

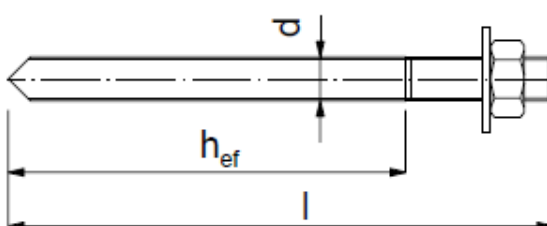

Threaded rod dimensions

Anchor size			M8	M10	M12	M16
Diameter of anchor rod	d	[mm] =	8	10	12	16
Size of sleeve	d _{nom} x l _s	[mm] =	12 x 80	16 x 85	20 x 85	20 x 85
			16 x 85	16 x 130	20 x 130	20 x 130
			16 x 130		20 x 200	20 x 200
Effective anchorage depth	h _{ef}	[mm] =	80 / 85 / 130	85 / 130	85 / 130 / 200	
Maximum diameter hole in fixture	d _{fix}	[mm] ≤	9	12	14	18
Installation torque moment	T _{inst}	[Nm] =	2	2	2	2
Depth of drilled hole to deepest point	h _l	[mm] =	h _{ef} + 5 mm			

Injection System VT-HP® for masonry

Product description
Anchor rods

Annex A3

Table A1: Materials	
Designation	Material
Steel, zinc plated $\geq 5 \mu\text{m}$ acc. to EN ISO 4042:1999 or Steel, Hot-dip galvanised $\geq 40 \mu\text{m}$ acc. to EN ISO 1461:2009 and EN ISO 10684:2004+AC:2009	
Anchor rod	Steel, EN 10087:1998 or EN 10263:2001 Property class 4.6, 4.8, 5.6, 5.8, 8.8 acc. EN 1993-1-8:2005+AC:2009 $A_s > 8\%$ fracture elongation
Hexagon nut, EN ISO 4032:2012	Steel acc. EN 10087:1998 or EN 10263:2001 Property class 4 (for class 4.6, 4.8 rod) EN ISO 898-2:2012 Property class 5 (for class 5.6, 5.8 rod) EN ISO 898-2:2012 Property class 8 (for class 8.8 rod) EN ISO 898-2:2012
Washer, EN ISO 887:2006, EN ISO 7089:2000, EN ISO 7093:2000, or EN ISO 7094:2000	Steel, zinc plated or hot-dip galvanised
Stainless steel	
Anchor rod	Material 1.4401 / 1.4404 / 1.4571, EN 10088-1:2014, Property class 70 EN ISO 3506-1:2009 Property class 80 EN ISO 3506-1:2009
Hexagon nut, EN ISO 4032:2012	Material 1.4401 / 1.4404 / 1.4571 EN 10088-1:2014, Property class 70 (for class 70 rod) EN ISO 3506-2:2009 Property class 80 (for class 80 rod) EN ISO 3506-2:2009
Washer, EN ISO 887:2006, EN ISO 7089:2000, EN ISO 7093:2000, or EN ISO 7094:2000	Material 1.4401, 1.4404 or 1.4571, EN 10088-1:2014
High corrosion resistant steel (HCR)	
Anchor rod	Material 1.4529 / 1.4565, EN 10088-1:2014, Property class 70 EN ISO 3506-1:2009 Property class 80 EN ISO 3506-1:2009
Hexagon nut, EN ISO 4032:2012	Material 1.4529 / 1.4565, EN 10088-1:2014, Property class 70 (for class 70 rod) EN ISO 3506-2:2009 Property class 80 (for class 80 rod) EN ISO 3506-2:2009
Washer, EN ISO 887:2006, EN ISO 7089:2000, EN ISO 7093:2000, or EN ISO 7094:2000	Material 1.4529 / 1.4565, EN 10088-1:2014
Plastic sleeve	
Perforated nylon sleeve	Material: nylon
Injection System VT-HP® for masonry	Annex A4
Product description Materials	

Table A2: Sleeve (Nylon)

12x80
16x85
20x85

$$L_s = h_{ef} = h_{nom}$$

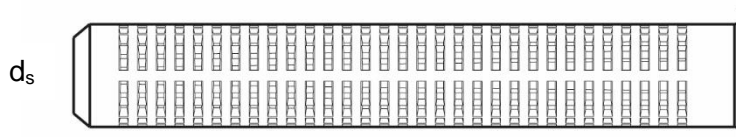

16x130
20x130
20x200

$$L_s = h_{ef} = h_{nom}$$

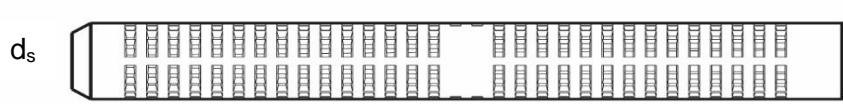

Table A3: Sizes sleeve

		Sleeve	12x80	16x85	16x130	20x85	20x130	20x200
Diameter of sleeve	$d_s = d_{nom}$	[mm]	12	16	16	20	20	20
Length of sleeve	L_s	[mm]	80	85	130	85	130	200
Effective anchorage depth	h_{ef}	[mm]	80	85	130	85	130	200
Overall anchor embedment	h_{nom}	[mm]	80	85	130	85	130	200

Table A4: Steel

Anchor rod			M8	M10	M12	M16
Outside diameter of anchor	$d_1 = d_{nom}$	[mm]	8	10	12	16
Total length of steel element	l_{ges}	[mm]	$h_{ef} + t_{fix} + 9,5$	$h_{ef} + t_{fix} + 11,5$	$h_{ef} + t_{fix} + 17,5$	$h_{ef} + t_{fix} + 20,0$

Injection System VT-HP® for masonry

Product description
Sleeves

Annex A5

Specifications of intended use

Anchorage subject to:

- Static and quasi-static loads

Base materials:

- Autoclaved Aerated Concrete (Use category d) according to Annex B2
- Solid brick masonry (Use category b), according to Annex B2.
- Hollow brick masonry (use category c), according to Annex B2 and B3
- Mortar strength class of the masonry M2,5 at minimum according to EN 998-2:2010.

Note: For other bricks in solid masonry and in hollow or perforated masonry, the characteristic resistance of the anchor may be determined by job site tests according to EOTA TR 53 under consideration of the β factor according to Annex C1, Table C1

Note: The characteristic resistance for solid bricks and autoclaved aerated concrete are also valid for larger brick sizes and larger compressive strength of the masonry unit.

Temperature Range:

- T_a : - 40°C to +40°C (max. short term temperature +40°C and max. long term temperature +24°C)
- T_b : - 40°C to +80°C (max. short term temperature +80°C and max. long term temperature +50°C)
- T_c : - 40°C to +120°C (max. short term temperature +120°C and max. long term temperature +72°C)

Use conditions (Environmental conditions):

- Dry and wet structure (regarding injection mortar).
- Structures subject to dry internal conditions (zinc coated steel, stainless steel or high corrosion resistant steel).
- Structures subject to external atmospheric exposure (including industrial and marine environment) and to permanently damp internal condition, if no particular aggressive conditions exist (stainless steel or high corrosion resistant steel).
- Structures subject to external atmospheric exposure and to permanently damp internal condition, if other particular aggressive conditions exist (high corrosion resistant steel).

Note: Particular aggressive conditions are e.g. permanent, alternating immersion in seawater or the splash zone of seawater, chloride atmosphere of indoor swimming pools or atmosphere with extreme chemical pollution (e.g. in desulphurization plants or road tunnels where de-icing materials are used).

Use categories in respect of installation and use:

- Category d/d: Installation and use in dry masonry
- Category w/w: Installation and use in dry or wet masonry (incl. w/d installation in wet masonry and use in dry masonry)

Design:









- Verifiable calculation notes and drawings are prepared taking account the relevant masonry in the region of the anchorage, the loads to be transmitted and their transmission to the supports of the structure. The position of the anchor is indicated on the design drawings.
- The anchorages are designed in accordance with the EOTA TR 054, Design method A under the responsibility of an engineer experienced in anchorages and masonry work.
- $N_{Rk,p} = N_{Rk,b}$ see Annex C4 to C45; $N_{Rk,s}$ see Annex C2; $N_{Rk,pb}$ see ETAG 029, Annex C
- $V_{Rk,b}$ and $V_{Rk,c}$ see Annex C4 to C45; $V_{Rk,s}$ see Annex C2; $V_{Rk,pb}$ see ETAG 029, Annex C
- For application with sleeve with drill bit size ≤ 15 mm installed in joints not filled with mortar:
 - o $N_{Rk,p,j} = 0,18 * N_{Rk,p}$ and $N_{Rk,b,j} = 0,18 * N_{Rk,b}$ ($N_{Rk,p} = N_{Rk,b}$ see Annex C4 to C45)
 - o $V_{Rk,c,j} = 0,15 * V_{Rk,c}$ and $V_{Rk,b,j} = 0,15 * V_{Rk,b}$ ($V_{Rk,b}$ and $V_{Rk,c}$ see Annex C4 to C45)
- Application without sleeve installed in joints not filled with mortar is not allowed.

Installation:

- Dry or wet structures.
- Anchor Installation carried out by appropriately qualified personnel and under the supervision of the person responsible for technical matters of the site.

Injection System VT-HP® for masonry	Annex B1
Intended Use Specifications	

Table B1: Overview brick types and properties with corresponding fastening elements (Anchor and Sleeves)							
Brick-No.	Brick type	Picture	Brick size	Compressive strength	Bulk density	Sleeve - Anchor type	Annex
			length width height				
Autoclaved aerated concrete units according EN 771-4							
1	Autoclaved Aerated Concrete AAC6		499 240 249	6	0,6	M8/M10/M12/M16	C4 – C5
Calcium silicate masonry units according EN 771-2							
2	Calcium silicate solid brick KS-NF		240 115 71	10 20 27	2,0	M8/M10/M12/M16/ 12x80 – M8 16x85 – M8/M10 16x130 – M8/M10 20x85 – M12/M16 20x130 – M12/M16 20x200 – M12/M16	C6 – C8
3	Calcium silicate hollow brick KSL-3DF		240 175 113	8 12 14	1,4	12x80 – M8 16x85 – M8/M10 16x130 – M8/M10 20x85 – M12/M16 20x130 – M12/M16 20x200 – M12/M16	C9 - C11
4	Calcium silicate hollow brick KSL-12DF		498 175 238	10 12 16	1,4	12x80 – M8 16x85 – M8/M10 16x130 – M8/M10 20x85 – M12/M16 20x130 – M12/M16	C12 - C14
Clay masonry units according EN 771-1							
5	Clay solid brick Mz – DF		240 115 55	10 20 28	1,6	M8/M10/M12/M16 12x80 – M8 16x85 – M8/M10 16x130 – M8/M10 20x85 – M12/M16 20x130 – M12/M16 20x200 – M12/M16	C15 - C17
6	Clay hollow brick Hlz-16DF		497 240 238	6 8 12 14	0,8	12x80 – M8 16x85 – M8/M10 16x130 – M8/M10 20x85 – M12/M16 20x130 – M12/M16 20x200 – M12/M16	C18 - C20
7	Clay hollow brick Porotherm Homebrick		500 200 299	4 6 10	0,7	12x80 – M8 16x85 – M8/M10 16x130 – M8/M10 20x85 – M12/M16 20x130 – M12/M16	C21 - C23
Injection System VT-HP® for masonry						Annex B2	
Intended Use Brick types and properties with corresponding fastening elements							

Table B1: Overview brick types and properties with corresponding fastening elements (Anchor and Sleeves) (continue)							
Brick-No.	Brick type	Picture	Brick size	Compressive strength	Bulk density	Sleeve - Anchor type	Annex
			length width height [mm]				
Clay masonry units according EN 771-1							
8	Clay hollow brick BGV Thermo		500 200 314	4 6 10	0,6	12x80 – M8 16x85 – M8/M10 16x130 – M8/M10 20x85 – M12/M16 20x130 – M12/M16	C24 - C26
9	Clay hollow brick Calibric R+		500 200 314	6 9 12	0,6	12x80 – M8 16x85 – M8/M10 16x130 – M8/M10 20x85 – M12/M16 20x130 – M12/M16	C27- C29
10	Clay hollow brick Urbanbric		560 200 274	6 9 12	0,7	12x80 – M8 16x85 – M8/M10 16x130 – M8/M10 20x85 – M12/M16 20x130 – M12/M16	C30 - C32
11	Clay hollow brick Brique creuse C40		500 200 200	4 8 12	0,7	12x80 – M8 16x85 – M8/M10 16x130 – M8/M10 20x85 – M12/M16 20x130 – M12/M16	C33 - C35
12	Clay hollow brick Blocchi Leggeri		250 120 250	4 6 8 12	0,6	12x80 – M8 16x85 – M8/M10 16x130 – M8/M10 20x85 – M12/M16 20x130 – M12/M16 20x200 – M12/M16	C36 - C38
13	Clay hollow brick Doppio Uni		250 120 120	10 16 20 28	0,9	12x80 – M8 16x85 – M8/M10 16x130 – M8/M10 20x85 – M12/M16 20x130 – M12/M16 20x200 – M12/M16	C39 - C41
Light weight concrete according EN 771-3							
14	Hollow light weight concrete Bloc creux B40		494 200 190	4	0,8	12x80 – M8 16x85 – M8/M10 16x130 – M8/M10 20x85 – M12/M16 20x130 – M12/M16	C42 - C43
15	Solid light weight concrete		300 123 248	2	0,6	M8/M10/M12/M16 12x80 – M8 16x85 – M8/M10 16x130 – M8/M10 20x85 – M12/M16 20x130 – M12/M16 20x200 – M12/M16	C44 - C45
Injection System VT-HP® for masonry						Annex B3	
Intended Use Brick types and properties with corresponding fastening elements							

Installation: Steel Brush**Table B2: Installation parameters in autoclaved aerated concrete AAC and solid masonry (without sleeve)**

Anchor size			M8	M10	M12	M16
Nominal drill hole diameter	d_0	[mm]	10	12	14	18
Drill hole depth	h_0	[mm]	80	90	100	100
Effective anchorage depth	h_{ef}	[mm]	80	90	100	100
Minimum wall thickness	h_{min}	[mm]	$h_{ef} + 30$			
Diameter of clearance hole in the fixture	$d_f \leq$	[mm]	9	12	14	18
Diameter of steel brush						
	d_b	[mm]	12	14	16	20
Minimum diameter of steel brush	$d_{b,min}$	[mm]	10,5	12,5	14,5	18,5
Max installation torque moment	$T_{inst,max}$	[Nm]	2 (14 for brick type Mz DF)			

Table B3: Installation parameters in solid and hollow masonry (with sleeve)

Anchor size			M8	M8 / M10		M12 / M16		
Sleeve			12x80	16x85	16x130	20x85	20x130	20x200
Nominal drill hole diameter	d_0	[mm]	12	16	16	20	20	20
Drill hole depth	h_0	[mm]	85	90	135	90	135	205
Effective anchorage depth	h_{ef}	[mm]	80	85	130	85	130	200
Minimum wall thickness	h_{min}	[mm]	115	115	175	115	175	240
Diameter of clearance hole in the fixture	$d_f \leq$	[mm]	9	9 (M8) / 12 (M10)		14 (M12) / 18 (M16)		
Diameter of steel brush								
	d_b	[mm]	14	18		22		
Minimum diameter of steel brush	$d_{b,min}$	[mm]	12,5	16,5		20,5		
Max installation torque moment	$T_{inst,max}$	[Nm]	2					

Injection System VT-HP® for masonry

Intended Use

Installation parameters and cleaning brush

Annex B4

Table B4: Maximum working time and minimum curing time			
Temperature in the base material T	Temperature of cartridge	Gelling- / working time	Minimum curing time in dry base material ¹⁾
0°C to + 4 °C	+5°C to +40°C	45 min	7 h
+ 5 °C to + 9 °C		25 min	2 h
+ 10 °C to + 19 °C		15 min	80 min
+ 20 °C to + 29 °C		6 min	45 min
+ 30 °C to + 34 °C		4 min	25 min
+ 35 °C to + 39 °C		2 min	20 min
+ 40°C		1,5 min	15 min
1) In wet base material the curing time must be doubled			
Resin injection dispensing tools details			
Image	Size Cartridge	Type	
	165 / 300ml 165 / 300 ml 10:1	Manual	
	345 / 380 / 400 / 410 / 420ml 380 / 400 / 410 / 420ml 10:1 345 ml 10:1	Manual	
	165 / 300 / 345 / 380 / 400 / 410 / 420ml 165 / 300 ml 345ml 380 / 400 / 410 / 420 ml	Battery	
	380 / 400 / 410 / 420 / 825ml 380 / 400 / 410 / 420 ml 825ml	Pneumatic	
Injection System VT-HP® for masonry		Annex B5	
Intended Use Gelling and Curing times / Injection tools			

Installation Instructions

Preparation of cartridge

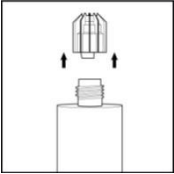

1. Remove the cap and attach the supplied static-mixing nozzle to the cartridge and load the cartridge into the correct dispensing tool. Cut open the foil bag below the clip if necessary. For every working interruption longer than the recommended working time (Annex B5) as well as for new cartridges, a new static-mixer shall be used.

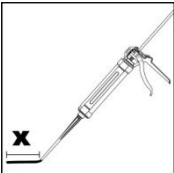

2. Initial adhesive is not suitable for fixing the anchor. Prior to dispensing into the anchor hole, squeeze out separately a minimum of three full strokes, for foil tube cartridges six full strokes and discard non-uniformly mixed adhesive components until the mortar shows a consistent grey colour.

Installation in solid masonry (without sleeve)

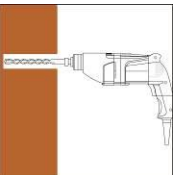

3. Holes to be drilled perpendicular to the surface of the base material by using a hard-metal tipped hammer drill bit. Drill a hole, with drilling method according to Annex C4-C45, into the base material, with nominal drill hole diameter and bore hole depth according to the size and embedment depth required by the selected anchor. In case of aborted drill hole the drill hole shall be filled with mortar.

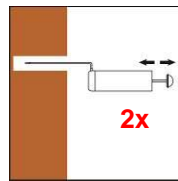
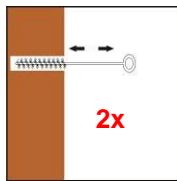
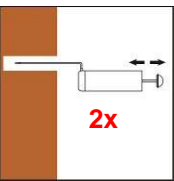

4. Blow out from the bottom of the bore hole two times. Attach the appropriate sized brush ($> d_{b,min}$ Table B2 or B3) to a drilling machine or a battery screwdriver, brush the hole clean two times, and finally blow out the hole again two times.

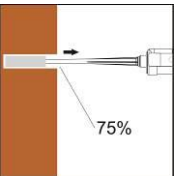

5. Starting from the bottom or back of the cleaned anchor hole, fill the hole up to min two-thirds with adhesive. Slowly withdraw the static mixing nozzle will avoid creating air pockets. Observe the gel-/ working times given in Annex B5.

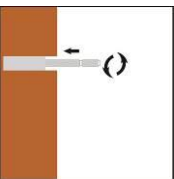

6. The position of the embedment depth shall be marked on the threaded rod. Push the threaded rod into the anchor hole while turning slightly to ensure positive distribution of the adhesive until the embedment depth is reached. The anchor shall be free of dirt, grease, oil or other foreign material.

7. Be sure that the annular gap is fully filled with mortar. If no excess mortar is visible at the top of the hole, the application has to be renewed.

8. Allow the adhesive to cure to the specified curing time prior to applying any load or torque. Do not move or load the anchor until it is fully cured (attend Annex B5).

9. After full curing, the fixture can be installed with up to the max. installation torque (see Annex B4) by using a calibrated torque wrench.

Injection System VT-HP® for masonry

Intended Use

Installation instructions Solid masonry and Autoclaved Aerated Concrete

Annex B6

Installation in solid and hollow masonry (with sleeve)

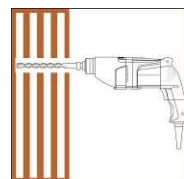

3. Holes to be drilled perpendicular to the surface of the base material by using a hard-metal tipped hammer drill bit. Drill a hole, with drill method according to Annex C4 – C45, into the base material, with nominal drill hole diameter and bore hole depth according to the size and embedment depth required by the selected anchor.

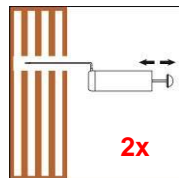
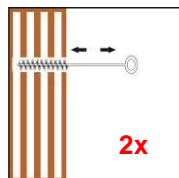
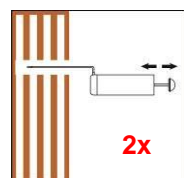

4. Blow out from the bottom of the bore hole two times. Attach the appropriate sized brush ($> d_{b,min}$ Table B3) to a drilling machine or a battery screwdriver, brush the hole clean two times, and finally blow out the hole again two times.

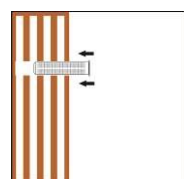

5. Insert the perforated sleeve flush with the surface of the masonry or plaster. Only use sleeves that have the right length. Never cut the sleeve.

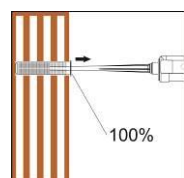

6. Starting from the bottom or back fill the sleeve with adhesive. For embedment depth equal to or larger than 130 mm an extension nozzle shall be used. For quantity of mortar attend cartridges label installation instructions. Observe the gel-/ working times given in Annex B5.

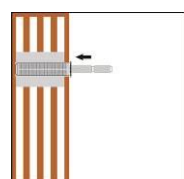

7. The position of the embedment depth shall be marked on the threaded rod. Push the threaded rod into the anchor hole while turning slightly to ensure positive distribution of the adhesive until the embedment depth is reached. The anchor shall be free of dirt, grease, oil or other foreign material.

8. Allow the adhesive to cure to the specified curing time prior to applying any load or torque. Do not move or load the anchor until it is fully cured (attend Annex B5).

9. After full curing, the fixture can be installed with up to the max. installation torque (see Annex B4) by using a calibrated torque wrench.

Injection System VT-HP® for masonry

Intended Use

Installation instructions hollow brick

Annex B7

Table C1: β-factor for job-site testing under tension loading							
Brick-No. and abbreviation	Installation & Use category	β-factor					
		T_a: 40°C / 24°C		T_b: 80°C / 50°C		T_c: 120°C / 72°C	
		d/d	w/d w/w	d/d	w/d w/w	d/d	w/d w/w
1 AAC6	For all sizes	0,95	0,86	0,81	0,73	0,81	0,73
2 KS-NF	d ₀ ≤ 14 mm	0,93	0,80	0,87	0,74	0,65	0,56
	d ₀ ≥ 16 mm	0,93	0,93	0,87	0,87	0,65	0,65
3 KSL-3DF	d ₀ ≤ 12 mm	0,93	0,80	0,87	0,74	0,65	0,56
	d ₀ ≥ 16 mm	0,93	0,93	0,87	0,87	0,65	0,65
4 KSL-12DF	d ₀ ≤ 12 mm	0,93	0,80	0,87	0,74	0,65	0,56
	d ₀ ≥ 16 mm	0,93	0,93	0,87	0,87	0,65	0,65
5 MZ-DF	For all sizes	0,86	0,86	0,86	0,86	0,73	0,73
6 Hz-16DF							
7 Porotherm Homebric							
8 BGV-Thermo							
9 Calibric R+							
10 Urbanbric							
11 Brique creuse C40							
12 Blocchi Leggeri							
13 Doppio Uni							
14 Bloc creux B40	d ₀ ≤ 12 mm	0,93	0,80	0,87	0,74	0,65	0,56
	d ₀ ≥ 16 mm	0,93	0,93	0,87	0,87	0,65	0,65
15 Solid light weight concrete	d ₀ ≤ 12 mm	0,93	0,80	0,87	0,74	0,65	0,56
	d ₀ ≥ 16 mm	0,93	0,93	0,87	0,87	0,65	0,65
Injection System VT-HP® for masonry						Annex C1	
Performances β-factors for job site testing under tension load							

Table C2: Characteristic steel resistance

Size		M8	M10	M12	M16
Characteristic tension resistance					
Steel, property class 4.6	$N_{Rk,s}$ [kN]	15	23	34	63
	γ_{Ms} [-]	2,0			
Steel, property class 4.8	$N_{Rk,s}$ [kN]	15	23	34	63
	γ_{Ms} [-]	1,5			
Steel, property class 5.6	$N_{Rk,s}$ [kN]	18	29	42	79
	γ_{Ms} [-]	2,0			
Steel, property class 5.8	$N_{Rk,s}$ [kN]	18	29	42	79
	γ_{Ms} [-]	1,5			
Steel, property class 8.8	$N_{Rk,s}$ [kN]	29	46	67	126
	γ_{Ms} [-]	1,5			
Stainless steel A4 / HCR, property class 70	$N_{Rk,s}$ [kN]	26	41	59	110
	γ_{Ms} [-]	1,87			
Stainless steel A4 / HCR, property class 80	$N_{Rk,s}$ [kN]	29	46	67	126
	γ_{Ms} [-]	1,6			
Characteristic shear resistance					
Steel, property class 4.6	$V_{Rk,s}$ [kN]	7	12	17	31
	γ_{Ms} [-]	1,67			
Steel, property class 4.8	$V_{Rk,s}$ [kN]	7	12	17	31
	γ_{Ms} [-]	1,25			
Steel, property class 5.6	$V_{Rk,s}$ [kN]	9	15	21	39
	γ_{Ms} [-]	1,67			
Steel, property class 5.8	$V_{Rk,s}$ [kN]	9	15	21	39
	γ_{Ms} [-]	1,25			
Steel, property class 8.8	$V_{Rk,s}$ [kN]	15	23	34	63
	γ_{Ms} [-]	1,25			
Stainless steel A4 / HCR, property class 70	$V_{Rk,s}$ [kN]	13	20	30	55
	γ_{Ms} [-]	1,56			
Stainless steel A4 / HCR, property class 80	$V_{Rk,s}$ [kN]	15	23	34	63
	γ_{Ms} [-]	1,33			
Characteristic bending moment					
Steel, property class 4.6	$M_{Rk,s}$ [Nm]	15	30	52	133
	γ_{Ms} [-]	1,67			
Steel, property class 4.8	$M_{Rk,s}$ [Nm]	15	30	52	133
	γ_{Ms} [-]	1,25			
Steel, property class 5.6	$M_{Rk,s}$ [Nm]	19	37	66	167
	γ_{Ms} [-]	1,67			
Steel, property class 5.8	$M_{Rk,s}$ [Nm]	19	37	66	167
	γ_{Ms} [-]	1,25			
Steel, property class 8.8	$M_{Rk,s}$ [Nm]	30	60	105	266
	γ_{Ms} [-]	1,25			
Stainless steel A4 / HCR, property class 70	$M_{Rk,s}$ [Nm]	26	52	92	233
	γ_{Ms} [-]	1,56			
Stainless steel A4 / HCR, property class 80	$M_{Rk,s}$ [Nm]	30	60	105	266
	γ_{Ms} [-]	1,33			
Injection System VT-HP® for masonry			Annex C2		
Performances Characteristic resistance under tension and shear load – steel failure					

Spacing and edge distances

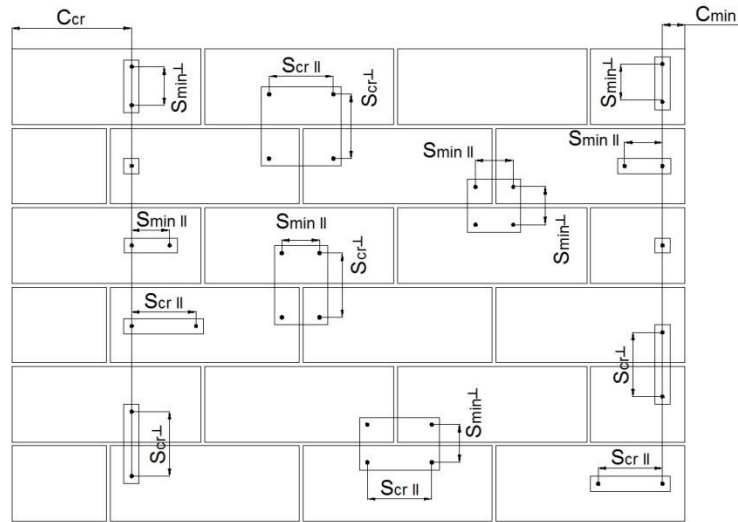

- C_{cr} = Characteristic edge distance
- C_{min} = Minimum Edge distance
- S_{cr} = Characteristic spacing
- S_{min} = Minimum spacing
- $S_{cr,||}$; ($S_{min,||}$) = Characteristic (minimum) spacing for anchors placed parallel to bed joint
- $S_{cr,⊥}$; ($S_{min,⊥}$) = Characteristic (minimum) spacing for anchors placed perpendicular to bed joint

Anchor position	Load direction		
	Tension load	Shear load parallel to free edge	Shear load perpendicular to free edge
Anchors places parallel to bed joint $S_{cr, }$; ($S_{min, }$)			
Anchors places perpendicular to bed joint $S_{cr,⊥}$; ($S_{min,⊥}$)			

- $\alpha_{g,N,||}$ = Group factor in case of tension load for anchors placed parallel to the bed joint
- $\alpha_{g,V,||}$ = Group factor in case of shear load for anchors placed parallel to the bed joint
- $\alpha_{g,N,⊥}$ = Group factor in case of tension load for anchors placed perpendicular to the bed joint
- $\alpha_{g,V,⊥}$ = Group factor in case of shear load for anchors placed perpendicular to the bed joint

Group of two anchors: $N_{RK}^g = \alpha_{g,N} * N_{RK}$ and $V_{RK}^g = \alpha_{g,V} * V_{RK}$

Group of four anchors: $N_{RK}^g = \alpha_{g,N,||} * \alpha_{g,N,⊥} * N_{RK}$ and $V_{RK}^g = \alpha_{g,V,||} * \alpha_{g,V,⊥} * V_{RK}$

(N_{RK} : $N_{RK,b}$ OR $N_{RK,b,j}$ for C_{cr})
 (V_{RK} : $V_{RK,c}$; $V_{RK,c,j}$; $V_{RK,b}$ OR $V_{RK,b,j}$ for C_{cr})
 (with the relevant α_g)

Injection System VT-HP® for masonry	Annex C3
Performances Edge distance and anchor spacing	

Brick type: Autoclaved Aerated Concrete – AAC6**Table C3: Description of the brick**

Brick type	Autoclaved Aerated Concrete AAC6	
Bulk density ρ [kg/dm ³]	0,6	
Compressive strength $f_b \geq$ [N/mm ²]	6	
Code	EN 771-4	
Producer (country code)	e.g. Porit (DE)	
Brick dimensions [mm]	499 x 240 x 249	
Drilling method	Rotary	

Table C4: Installation parameter

Anchor size		[-]	M8	M10	M12	M16
Effective anchorage depth		[mm]	80	90	100	100
Edge distance	C_{Cr}	[mm]	1,5* h_{ef}			
Minimum edge distance	$C_{min,N}$	[mm]	75			
	$C_{min,V,II}$ ($C_{min,v,\perp}$) ¹⁾	[mm]	75 (1,5* h_{ef})			
Spacing	S_{Cr}	[mm]	3* h_{ef}			
Minimum spacing	S_{min}	[mm]	100			

¹⁾ $C_{min,V,II}$ for shear loading parallel to the free edge; $C_{min,v,\perp}$ for shear loading perpendicular the free edge

Table C5: Group factor for anchor group in case of tension loading



Configuration		with $c \geq$	with $s \geq$			
II: anchors placed parallel to horizontal joint		125 (M8:120)	100	$\alpha_{g,N,II}$	[-]	1,8
		1,5* h_{ef}	3* h_{ef}			2,0
⊥: anchors placed perpendicular to horizontal joint		75	100	$\alpha_{g,N,\perp}$		1,4
		1,5* h_{ef}	3* h_{ef}			2,0

Table C6: Group factor for anchor group in case of shear loading parallel to free edge

Configuration		with $c \geq$	with $s \geq$			
II: anchors placed parallel to horizontal joint		75	100	$\alpha_{g,V,II}$	[-]	1,2
		1,5* h_{ef}	3* h_{ef}			2,0
⊥: anchors placed perpendicular to horizontal joint		1,5* h_{ef}	3* h_{ef}	$\alpha_{g,V,\perp}$		2,0

Injection System VT-HP® for masonry

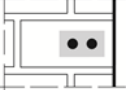
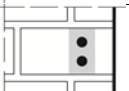
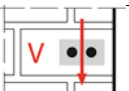
Performances Autoclaved Aerated Concrete - AAC6

Description of the brick

Installation parameters

Annex C4

Brick type: Autoclaved Aerated Concrete – AAC6**Table C7: Group factor for anchor group in case of shear loading perpendicular to free edge**

Configuration		with $c \geq$	with $s \geq$			
II: anchors placed parallel to horizontal joint		1,5*hef	3,0*hef	$\alpha_{g,V,II}$	[-]	2,0
I: anchors placed perpendicular to horizontal joint		1,5*hef	3,0*hef	$\alpha_{g,V,I}$		2,0

Table C8: Characteristic values of resistance under tension and shear loads

Anchor size	Effective anchorage depth	Characteristic resistance						
		Use category						
		d/d			w/w w/d			d/d w/d w/w
		40°C/24°C	80°C/50°C	120°C/72°C	40°C/24°C	80°C/50°C	120°C/72°C	For all temperature range
	hef	$N_{Rk,b} = N_{Rk,p}^{1)}$			$N_{Rk,b} = N_{Rk,p}^{1)}$			$V_{Rk,b}^{2)3)}$
	[mm]	[kN]						
Compressive strength $f_b \geq 6 \text{ N/mm}^2$								
M8	80	2,5	2,5	2,0	2,5	2,0	1,5	6,0
M10	90	4,0	3,0	2,5	3,5	3,0	2,5	10,0
M12	100	5,0	4,0	3,0	4,5	3,5	3,0	10,0
M16	100	6,5	5,5	4,0	5,5	5,0	4,0	10,0

1) Values are valid for C_{cr} , values in brackets are valid for single anchors with C_{min}

2) For calculation of $V_{Rk,c}$ see ETAG029, Annex C;

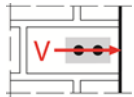
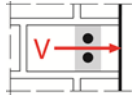
3) The values are valid for steel 5.6 or greater. For steel 4.6 and 4.8 multiply $V_{Rk,b}$ by 0,8

Table C9: Displacements

Anchor size	hef	N	$\delta N / N$	δN_0	δN_∞	V	δv_0	δv_∞
	[mm]	[kN]	[mm/kN]	[mm]	[mm]	[kN]	[mm]	[mm]
M8	80	0,9	0,18	0,16	0,32	1,3	0,8	1,20
M10	90	1,4		0,26	0,51	1,8	1,2	1,80
M12	100	1,8	0,08	0,14	0,29	2,1	1,4	2,10
M16	100	2,3		0,19	0,37	2,3	1,5	2,25

Injection System VT-HP® for masonry

Performances Autoclaved Aerated Concrete – AAC6

Installation parameters (continue)

Characteristic values of resistance under tension and shear load / Displacements

Annex C5

Brick type: Calcium silicate solid brick KS-NF**Table C10: Description of the brick**

Brick type	Calcium silicate solid brick KS-NF	
Bulk density ρ [kg/dm ³]	2,0	
Compressive strength $f_b \geq$ [N/mm ²]	10, 20 or 27	
Code	EN 771-2	
Producer (country code)	e.g. Wemding (DE)	
Brick dimensions [mm]	240 x 115 x 71	
Drilling method	Hammer	

Table C11: Installation parameter

Anchor size		[-]	All sizes
Edge distance	c_{cr}	[mm]	$1,5 \cdot h_{ef}$
Minimum edge distance	c_{min}	[mm]	60
Spacing	s_{cr}	[mm]	$3 \cdot h_{ef}$
Minimum spacing	s_{min}	[mm]	120

Table C12: Group factor for anchor group in case of tension loading

Configuration		with $c \geq$	with $s \geq$			
: anchors placed parallel to horizontal joint		60	120	$\alpha_{g,N, }$	[-]	1,0
		140	120			1,5
		$1,5 \cdot h_{ef}$	$3 \cdot h_{ef}$			2,0
⊥: anchors placed perpendicular to horizontal joint		60	120	$\alpha_{g,N,\perp}$		0,5
		$1,5 \cdot h_{ef}$	120			1,0
		$1,5 \cdot h_{ef}$	$3 \cdot h_{ef}$			2,0

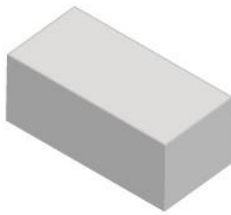
Table C13: Group factor for anchor group in case of shear loading parallel to free edge

Configuration		with $c \geq$	with $s \geq$			
: anchors placed parallel to horizontal joint		60	120	$\alpha_{g,V, }$	[-]	1,0
		115	120			1,7
		$1,5 \cdot h_{ef}$	$3 \cdot h_{ef}$			2,0
⊥: anchors placed perpendicular to horizontal joint		60	120	$\alpha_{g,V,\perp}$		1,0
		$1,5 \cdot h_{ef}$	120			1,0
		$1,5 \cdot h_{ef}$	$3 \cdot h_{ef}$			2,0

Table C14: Group factor for anchor group in case of shear loading perpendicular to free edge

Configuration		with $c \geq$	with $s \geq$			
: anchors placed parallel to horizontal joint		60	120	$\alpha_{g,V, }$	[-]	1,0
		$1,5 \cdot h_{ef}$	$3 \cdot h_{ef}$			2,0
⊥: anchors placed perpendicular to horizontal joint		60	120	$\alpha_{g,V,\perp}$		1,0
		$1,5 \cdot h_{ef}$	$3 \cdot h_{ef}$			2,0

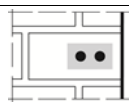
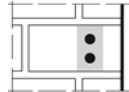
Injection System VT-HP® for masonry
Performances calcium solid brick KS-NF
 Installation parameters
Annex C6

Brick type: Calcium silicate solid brick KS-NF**Table C15: Characteristic values of resistance under tension and shear loads**

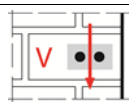
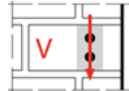
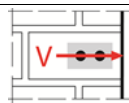
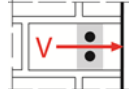
Anchor size	Sleeve	Effective anchorage depth h_{ef} [mm]	Characteristic resistance							
			Use category							
			d/d			w/d w/w			d/d w/d w/w	
			40°C/24°C	80°C/50°C	120°C/72°C	40°C/24°C	80°C/50°C	120°C/72°C	For All temperature range	
h_{ef}	$N_{Rk,b} = N_{Rk,p}^{1)}$			$N_{Rk,b} = N_{Rk,p}^{1)}$			$V_{Rk,b}^{2)3)}$			
[mm]	[kN]									
Compressive strength $f_b \geq 10 \text{ N/mm}^2$										
M8	-	80	4,5 (2,0)	4,5 (2,0)	3,0 (1,5)	3,5 (1,5)	3,5 (1,5)	2,5 (1,2)	2,5 (1,5)	
M10	-	90	4,5 (2,0)	4,5 (2,0)	3,0 (1,5)	3,5 (1,5)	3,5 (1,5)	2,5 (1,2)	3,0 (2,0)	
M12	-	100	4,5 (2,0)	4,5 (2,0)	3,0 (1,5)	3,5 (1,5)	3,5 (1,5)	2,5 (1,2)	2,5 (1,5)	
M16	-	100	3,5 (1,5)	3,5 (1,5)	2,5 (1,2)	3,0 (1,5)	3,5 (1,5)	2,0 (0,9)	2,5 (1,5)	
M8	12x80	80	3,5 (1,5)	3,5 (1,5)	2,5 (1,2)	3,5 (1,5)	3,0 (1,5)	2,5 (1,2)	2,5 (1,5)	
M8 /	16x85	85	3,5 (1,5)	3,0 (1,5)	2,0 (0,9)	3,5 (1,5)	3,0 (1,5)	2,5 (1,2)	2,5 (1,5)	
M10	16x130	130	3,5 (1,5)	3,0 (1,5)	2,0 (0,9)	3,5 (1,5)	3,0 (1,5)	2,5 (1,2)	2,5 (1,5)	
M12 /	20x85	85	3,0 (1,5)	2,5 (1,2)	2,0 (0,9)	3,0 (1,5)	2,5 (1,2)	2,0 (0,9)	2,5 (1,5)	
	M16	20x130	130	3,0 (1,5)	2,5 (1,2)	2,0 (0,9)	3,0 (1,5)	2,5 (1,2)	2,0 (0,9)	2,5 (1,5)
		20x200	200	3,0 (1,5)	2,5 (1,2)	2,0 (0,9)	3,0 (1,5)	2,5 (1,2)	2,0 (0,9)	2,5 (1,5)
Compressive strength $f_b \geq 20 \text{ N/mm}^2$										
M8	-	80	6,0 (3,0)	5,5 (2,5)	4,0 (2,0)	5,0 (2,5)	5,0 (2,5)	3,5 (1,5)	4,0 (2,5)	
M10	-	90	6,0 (3,0)	5,5 (2,5)	4,0 (2,0)	5,0 (2,5)	5,0 (2,5)	3,5 (1,5)	4,5 (2,5)	
M12	-	100	6,0 (3,0)	5,5 (2,5)	4,0 (2,0)	5,0 (2,5)	5,0 (2,5)	3,5 (1,5)	4,0 (2,5)	
M16	-	100	5,0 (2,5)	5,0 (2,5)	3,5 (1,5)	5,0 (2,5)	5,0 (2,5)	3,5 (1,5)	4,0 (2,5)	
M8	12x80	80	5,5 (2,5)	5,0 (2,5)	3,5 (1,5)	4,5 (2,0)	4,5 (2,0)	3,0 (1,5)	4,0 (2,5)	
M8 /	16x85	85	5,0 (2,5)	4,5 (2,0)	3,5 (1,5)	5,0 (2,5)	4,5 (2,0)	3,5 (1,5)	4,0 (2,5)	
M10	16x130	130	5,0 (2,5)	4,5 (2,0)	3,5 (1,5)	5,0 (2,5)	4,5 (2,0)	3,5 (1,5)	4,0 (2,5)	
M12 /	20x85	85	4,0 (2,0)	4,0 (2,0)	3,0 (1,5)	4,0 (2,0)	4,0 (2,0)	3,0 (1,5)	4,0 (2,5)	
	M16	20x130	130	4,0 (2,0)	4,0 (2,0)	3,0 (1,5)	4,0 (2,0)	3,0 (1,5)	4,0 (2,5)	
		20x200	200	4,0 (2,0)	4,0 (2,0)	3,0 (1,5)	4,0 (2,0)	3,0 (1,5)	4,0 (2,5)	

1) Values are valid for c_{cr} , values in brackets are valid for single anchors with c_{min}

2) For c_{cr} calculation of $V_{Rk,c}$ see ETAG 029, Annex C; values in brackets $V_{Rk,b} = V_{Rk,c}$ for single anchors with c_{min}

3) The values are valid for steel 5.6 or greater. For steel 4.6 and 4.8 multiply $V_{Rk,b}$ by 0,8

Injection System VT-HP® for masonry

Performances calcium solid brick KS-NF

Characteristic values of resistance under tension and shear load

Annex C7

Brick type: Calcium silicate solid brick KS-NF**Table C16: Characteristic values of resistance under tension and shear loads (continue)**

Anchor size	Sleeve	Effective anchorage depth h_{ef} [mm]	Characteristic resistance						
			Use category						
			d/d			w/d w/w			d/d w/d w/w
			40°C/24°C	80°C/50°C	120°C/72°C	40°C/24°C	80°C/50°C	120°C/72°C	For All temperature range
h_{ef}	$N_{Rk,b} = N_{Rk,p}^{1)}$			$N_{Rk,b} = N_{Rk,p}^{1)}$			$V_{Rk,b}^{2)3)}$		
[mm]	[kN]								
Compressive strength $f_b \geq 27 \text{ N/mm}^2$									
M8	-	80	7,0 (3,5)	6,5 (3,0)	5,0 (2,5)	6,0 (3,0)	5,5 (2,5)	4,0 (2,0)	4,5 (2,5)
M10	-	90	7,0 (3,5)	6,5 (3,0)	5,0 (2,5)	6,0 (3,0)	5,5 (2,5)	4,0 (2,0)	5,5 (3,0)
M12	-	100	7,0 (3,5)	6,5 (3,0)	5,0 (2,5)	6,0 (3,0)	5,5 (2,5)	4,0 (2,0)	4,5 (2,5)
M16	-	100	6,0 (3,0)	5,5 (2,5)	4,5 (2,0)	6,0 (3,0)	5,5 (2,5)	4,0 (2,0)	4,5 (2,5)
M8	12x80	80	6,5 (3,0)	6,0 (3,0)	4,5 (2,0)	5,5 (2,5)	5,0 (2,5)	3,5 (1,5)	4,5 (2,5)
M8 / M10	16x85	85	5,5 (2,5)	5,0 (2,5)	4,0 (2,0)	5,5 (2,5)	5,0 (2,5)	4,0 (2,0)	4,5 (2,5)
	16x130	130	5,5 (2,5)	5,0 (2,5)	4,0 (2,0)	5,5 (2,5)	5,0 (2,5)	4,0 (2,0)	4,5 (2,5)
M12 / M16	20x85	85	5,0 (2,5)	4,5 (2,0)	3,5 (1,5)	5,0 (2,5)	4,5 (2,0)	3,5 (1,5)	4,5 (2,5)
	20x130	130	5,0 (2,5)	4,5 (2,0)	3,5 (1,5)	5,0 (2,5)	4,5 (2,0)	3,5 (1,5)	4,5 (2,5)
	20x200	200	5,0 (2,5)	4,5 (2,0)	3,5 (1,5)	5,0 (2,5)	4,5 (2,0)	3,5 (1,5)	4,5 (2,5)

1) Values are valid for c_{cr} , values in brackets are valid for single anchors with c_{min}

2) For c_{cr} calculation of $V_{Rk,c}$ see ETAG 029, Annex C; values in brackets $V_{Rk,b} = V_{Rk,c}$ for single anchors with c_{min}

3) The values are valid for steel 5.6 or greater. For steel 4.6 and 4.8 multiply $V_{Rk,b}$ by 0,8

Table C17: Displacements

Anchor size	Sleeve	Effective anchorage depth h_{ef}	N	δ_N / N	δ_{N0}	$\delta_{N\infty}$	V	δ_{V0}	$\delta_{V\infty}$
M8	-	80	2,0	0,15	0,30	0,60	1,7	0,90	1,35
M10	-	90							
M12	-	100							
M16	-	100	1,7		0,26	0,51	1,7	0,90	1,35
M8 / M10	12x80	80							
	16x85	85	1,4		0,21	0,43			
16x130	130								
M12 / M16	20x85	85	1,3		0,19	0,39			
	20x130	130							
	20x200	200							

Injection System VT-HP® for masonry**Annex C8****Performances calcium solid brick KS-NF**

Characteristic values of resistance under tension and shear load (continue)

Displacements

Brick type: Calcium silicate hollow brick KS L-3DF

Table C18: Description of the brick

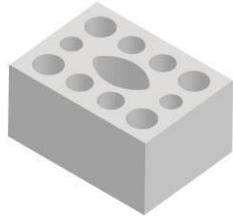
Brick type	Calcium silicate hollow brick KSL-3DF	
Bulk density ρ [kg/dm ³]	1,4	
Compressive strength $f_b \geq$ [N/mm ²]	8, 12 or 14	
Code	EN 771-2	
Producer (country code)	e.g. Wemding (DE)	
Brick dimensions [mm]	240 x 175 x 113	
Drilling method	Rotary	

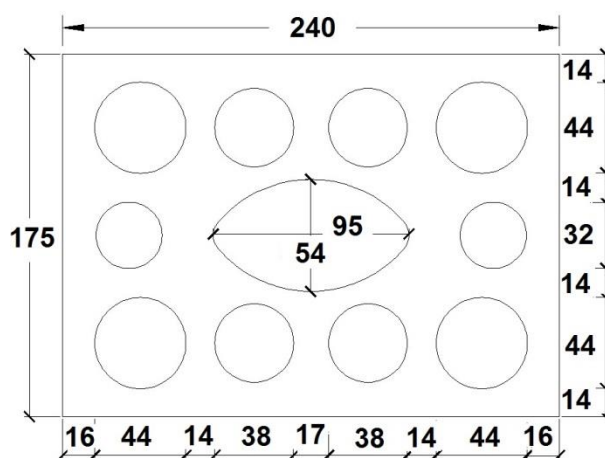
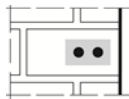
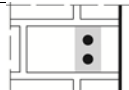

Table C19: Installation parameters

Anchor size		[-]	All sizes
Edge distance	C_{cr}	[mm]	100 (120) ¹⁾
Minimum edge distance	C_{min}	[mm]	60
Spacing	$S_{cr,II}$	[mm]	240
	$S_{cr,I}$	[mm]	120
Minimum spacing	S_{min}	[mm]	120

¹⁾ Value in brackets for sleeves 20x85; 20x130 and 20x200

Table C20: Group factor for anchor group in case of tension loading

Configuration		with $c \geq$	with $s \geq$			
II: anchors placed parallel to horizontal joint		60	120	$\alpha_{g,N,II}$	[-]	1,5
		C_{cr}	240			2,0
		160	120			2,0
I: anchors placed perpendicular to horizontal joint		60	120	$\alpha_{g,N,I}$	[-]	1,0
		C_{cr}	120			2,0

Injection System VT-HP® for masonry

Annex C9

Performances calcium hollow brick KS L-3DF

Description of the brick
Installation parameters

Brick type: Calcium silicate hollow brick KS L-3DF**Table C21: Group factor for anchor group in case of shear loading parallel to free edge**

Configuration		with $c \geq$	with $s \geq$			
II: anchors placed parallel to horizontal joint		60	120	$\alpha_{g,V,II}$	[-]	1,0
		160	120			1,6
		C_{cr}	240			2,0
⊥: anchors placed perpendicular to horizontal joint		60	120	$\alpha_{g,V,\perp}$	[-]	1,0
		C_{cr}	120			2,0

Table C22: Group factor for anchor group in case of shear loading perpendicular to free edge

Configuration		with $c \geq$	with $s \geq$			
II: anchors placed parallel to horizontal joint		60	120	$\alpha_{g,V,II}$	[-]	1,0
		C_{cr}	240			2,0
⊥: anchors placed perpendicular to horizontal joint		60	120	$\alpha_{g,V,\perp}$	[-]	1,0
		C_{cr}	120			2,0

Table C23: Characteristic values of resistance under tension and shear loads

Anchor size	Sleeve	Effective anchorage depth	Characteristic resistance						
			Use category						
			d/d			w/d; w/w			d/d; w/d; w/w
			40°C/24°C	80°C/50°C	120°C/72°C	40°C/24°C	80°C/50°C	120°C/72°C	For all temperature range
h_{ef}	$N_{Rk,b} = N_{Rk,p}^{1)}$			$N_{Rk,b} = N_{Rk,p}^{1)}$			$V_{Rk,b}^{4)}$		
		[mm]	[kN]						
Compressive strength $f_b \geq 8 \text{ N/mm}^2$									
M8	12x80	80	1,5	1,5	1,2	1,5	1,2	0,9	2,5 ²⁾ (0,9) ³⁾
M8 / M10	16x85	85	1,5	1,5	1,2	1,5	1,5	1,2	4,0 ²⁾ (1,5) ³⁾
	16x130	130	1,5	1,5	1,2	1,5	1,5	1,2	4,0 ²⁾ (1,5) ³⁾
M12 / M16	20x85	85	4,5	4,0	3,0	4,5	4,0	3,0	4,0 ²⁾ (1,5) ³⁾
	20x130	130	4,5	4,0	3,0	4,5	4,0	3,0	4,0 ²⁾ (1,5) ³⁾
	20x200	200	4,5	4,0	3,0	4,5	4,0	3,0	4,0 ²⁾ (1,5) ³⁾
Compressive strength $f_b \geq 12 \text{ N/mm}^2$									
M8	12x80	80	2,0	2,0	1,5	2,0	1,5	1,2	3,0 ²⁾ (1,2) ³⁾
M8 / M10	16x85	85	2,0	2,0	1,5	2,0	2,0	1,5	4,5 ²⁾ (1,5) ³⁾
	16x130	130	2,5	2,5	1,5	2,5	2,5	1,5	4,5 ²⁾ (1,5) ³⁾
M12 / M16	20x85	85	6,0	5,5	4,0	6,0	5,5	4,0	4,5 ²⁾ (1,5) ³⁾
	20x130	130	6,0	5,5	4,0	6,0	5,5	4,0	4,5 ²⁾ (1,5) ³⁾
	20x200	200	6,0	5,5	4,0	6,0	5,5	4,0	4,5 ²⁾ (1,5) ³⁾

1) Values are valid for C_{cr} and C_{min} 2) $V_{Rk,c,II} = V_{Rk,b}$ valid for shear load parallel to free edge3) $V_{Rk,c,\perp} = V_{Rk,b}$ (values in brackets) valid for shear load in direction to free edge4) The values are valid for steel 5.6 or greater. For steel 4.6 and 4.8 multiply $V_{Rk,b}$ by 0,8**Injection System VT-HP® for masonry****Performances calcium hollow brick KS L-3DF**

Installation parameters (continue)

Characteristic values of resistance under tension and shear load

Annex C10

Brick type: Calcium silicate hollow brick KS L-3DF**Table C24: Characteristic values of resistance under tension and shear loads (continue)**

Anchor size	Sleeve	Effective anchorage depth	Characteristic resistance						
			Use category						
			d/d			w/d w/w			d/d; w/d; w/w
			40°C/24°C	80°C/50°C	120°C/72°C	40°C/24°C	80°C/50°C	120°C/72°C	For all temperature range
h_{ef}	$N_{Rk,b} = N_{Rk,p}^{1)}$			$N_{Rk,b} = N_{Rk,p}^{1)}$			$V_{Rk,b}^{4)}$		
[mm]	[kN]								
Compressive strength $f_b \geq 14 \text{ N/mm}^2$									
M8	12x80	80	2,5	2,5	1,5	2,0	2,0	1,5	3,5 ²⁾ (1,5) ³⁾
M8 / M10	16x85	85	2,5	2,5	1,5	2,5	2,5	1,5	6,0 ²⁾ (2,0) ³⁾
	16x130	130	2,5	2,5	2,0	2,5	2,5	2,0	6,0 ²⁾ (2,0) ³⁾
M12 / M16	20x85	85	6,5	6,0	4,5	6,5	6,0	4,5	6,0 ²⁾ (2,0) ³⁾
	20x130	130	6,5	6,0	4,5	6,5	6,0	4,5	6,0 ²⁾ (2,0) ³⁾
	20x200	200	6,5	6,0	4,5	6,5	6,0	4,5	6,0 ²⁾ (2,0) ³⁾

1) Values are valid for C_{cr} and C_{min} 2) $V_{Rk,c,II} = V_{Rk,b}$ valid for shear load parallel to free edge3) $V_{Rk,c,I} = V_{Rk,b}$ (values in brackets) valid for shear load in direction to free edge4) The values are valid for steel 5.6 or greater. For steel 4.6 and 4.8 multiply $V_{Rk,b}$ by 0,8**Table C25: Displacements**

Anchor size	Sleeve	Effective anchorage depth h_{ef}	N	δ_N / N	δ_{N0}	$\delta_{N\infty}$	V	δ_{V0}	$\delta_{V\infty}$
			[kN]	[mm/kN]	[mm]	[mm]	[kN]	[mm]	[mm]
M8	12x80	80	0,71	0,90	0,64	1,29	1,0	1,0	1,50
M8 / M10	16x85	85							
		16x130	130				1,7	1,9	2,85
M12 / M16	20x85	85	1,86	0,90	1,67	3,34			
	20x130	130							
	20x200	200							

Injection System VT-HP® for masonry**Annex C11****Performances calcium hollow brick KS L-3DF**

Characteristic values of resistance under tension and shear load (continue)

Displacements

Brick type: Calcium silicate hollow brick KS L-12DF

Table C26: Description of the brick

Brick type	Calcium silicate hollow brick KSL-12DF	
Bulk density ρ [kg/dm ³]	1,4	
Compressive strength $f_b \geq$ [N/mm ²]	10, 12 or 16	
Code	EN 771-2	
Producer (country code)	e.g. Wemding (DE)	
Brick dimensions [mm]	498 x 175 x 238	
Drilling method	Rotary	

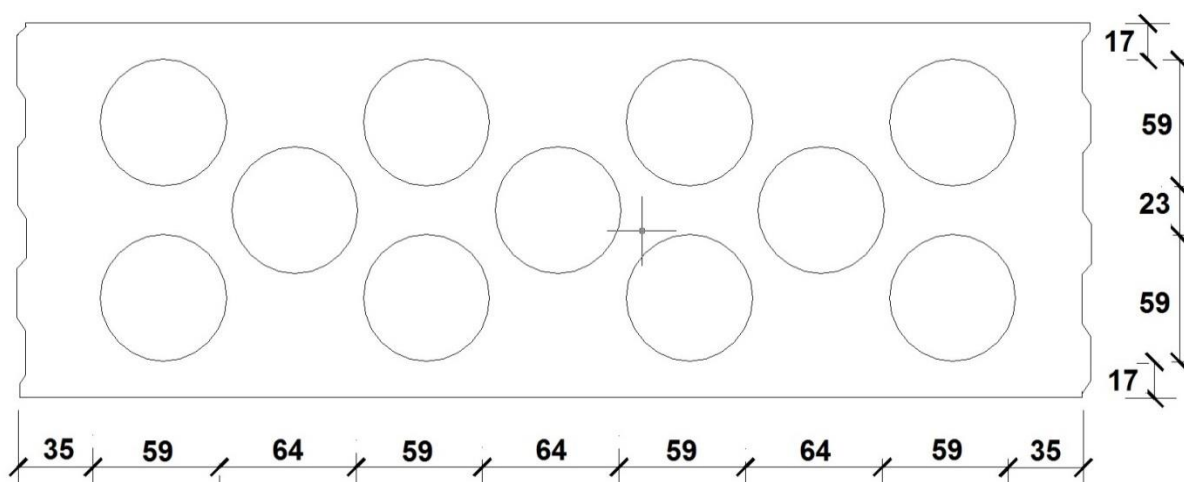

Table C27: Installation parameters

Anchor size		[-]	All sizes
Edge distance	C_{cr}	[mm]	100 (120) ¹⁾
Minimum edge distance	$C_{min}^{2)}$	[mm]	100 (120) ¹⁾
Spacing	$S_{cr,II}$	[mm]	498
	$S_{cr,\perp}$	[mm]	238
Minimum spacing	S_{min}	[mm]	120

¹⁾ Value in brackets for sleeves 20x85 and 20x130

²⁾ For $V_{Rk,c}$: C_{min} according to ETAG 029, Annex C

Table C28: Group factor for anchor group in case of tension loading

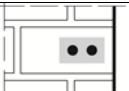
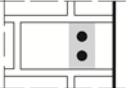
Configuration		with $c \geq$	with $s \geq$			
II: anchors placed parallel to horizontal joint		100	120	$\alpha_{g,N,II}$	[-]	1,0
		C_{cr}	498			2,0
\perp : anchors placed perpendicular to horizontal joint		100	120	$\alpha_{g,N,\perp}$		1,0
		C_{cr}	238			2,0

Injection System VT-HP® for masonry

Annex C12

Performances Calcium hollow brick KS L-12DF

Description of the brick

Installation parameters

Brick type: Calcium silicate hollow brick KS L-12DF**Table C29: Group factor for anchor group in case of shear loading parallel to free edge**



Configuration		with $c \geq$	with $s \geq$			
II: anchors placed parallel to horizontal joint		C_{cr}	498	$\alpha_{g,V,II}$	[-]	2,0
I: anchors placed perpendicular to horizontal joint		C_{cr}	238	$\alpha_{g,V,I}$		2,0

Table C30: Group factor for anchor group in case of shear loading perpendicular to free edge

Configuration		with $c \geq$	with $s \geq$			
II: anchors placed parallel to horizontal joint		C_{cr}	498	$\alpha_{g,V,II}$	[-]	2,0
I: anchors placed perpendicular to horizontal joint		C_{cr}	238	$\alpha_{g,V,I}$		2,0

Table C31: Characteristic values of resistance under tension and shear loads

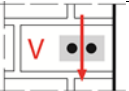
Anchor size	Sleeve	Effective anchorage depth	Characteristic resistance						
			Use category						
			d/d			w/d w/w			d/d w/d w/w
			40°C/24°C	80°C/50°C	120°C/72°C	40°C/24°C	80°C/50°C	120°C/72°C	For all temperature range
h_{ef}	$N_{Rk,b} = N_{Rk,p}^{1)}$			$N_{Rk,b} = N_{Rk,p}^{1)}$			$V_{Rk,b}^{2)3)}$		
		[mm]	[kN]						
Compressive strength $f_b \geq 10 \text{ N/mm}^2$									
M8	12x80	80	0,6	0,6	0,4	0,5	0,5	0,4	2,5
M8 / M10	16x85	85	0,6	0,6	0,4	0,6	0,6	0,4	5,5
	16x130	130	2,5	2,5	2,0	2,5	2,5	2,0	5,5
M12 / M16	20x85	85	1,5	1,5	0,9	1,5	1,5	0,9	5,5
	20x130	130	2,5	2,5	2,0	2,5	2,5	2,0	5,5
Compressive strength $f_b \geq 12 \text{ N/mm}^2$									
M8	12x80	80	0,75	0,6	0,5	0,6	0,6	0,4	3,0
M8 / M10	16x85	85	0,75	0,6	0,5	0,75	0,6	0,5	6,5
	16x130	130	3,0	3,0	2,0	3,0	3,0	2,0	6,5
M12 / M16	20x85	85	1,5	1,5	1,2	1,5	1,5	1,2	6,5
	20x130	130	3,0	3,0	2,0	3,0	3,0	2,0	6,5

1) Values are valid for c_{cr} and c_{min} 2) Calculation of $V_{Rk,c}$ see ETAG 029, Annex C, except for shear load parallel to free edge with $c \geq 120 \text{ mm}$: $V_{Rk,c,II} = V_{Rk,b}$ 3) The values are valid for steel 5.6 or greater. For steel 4.6 and 4.8 multiply $V_{Rk,b}$ by 0,8**Injection System VT-HP® for masonry****Performances calcium hollow brick KS L-12DF**

Installation parameters (continue)

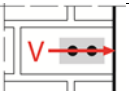
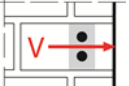
Characteristic values of resistance under tension and shear load

Annex C13

Brick type: Calcium silicate hollow brick KS L-12DF**Table C32: Characteristic values of resistance under tension and shear loads (continue)**

Anchor size	Sleeve	Effective anchorage depth	Characteristic resistance						
			Use category						
			d/d			w/d w/w			d/d w/d w/w
			40°C/24°C	80°C/50°C	120°C/72°C	40°C/24°C	80°C/50°C	120°C/72°C	For all temperature range
			h_{ef}	$N_{Rk,b} = N_{Rk,p}^{1)}$			$N_{Rk,b} = N_{Rk,p}^{1)}$		
[mm]	[kN]								
Compressive strength $f_b \geq 16 \text{ N/mm}^2$									
M8	12x80	80	0,9	0,9	0,6	0,75	0,75	0,5	3,5
M8 / M10	16x85	85	0,9	0,9	0,6	0,9	0,9	0,6	8,0
	16x130	130	4,0	3,5	2,5	4,0	3,5	2,5	8,0
M12 / M16	20x85	85	2,0	2,0	1,5	2,0	2,0	1,5	8,0
	20x130	130	4,0	3,5	2,5	4,0	3,5	2,5	8,0

1) Values are valid for c_{cr} and c_{min} 2) Calculation of $V_{Rk,c}$ see ETAG 029, Annex C, except for shear load parallel to free edge with $c \geq 120 \text{ mm}$: $V_{Rk,c,II} = V_{Rk,b}$ 3) The values are valid for steel 5.6 or greater. For steel 4.6 and 4.8 multiply $V_{Rk,b}$ by 0,8**Table C33: Displacements**

Anchor size	Sleeve	Effective anchorage depth	N	δ_N / N	δ_{N0}	$\delta_{N\infty}$	V	δ_{V0}	$\delta_{V\infty}$
		h_{ef}							
		[mm]	[kN]	[mm/kN]	[mm]	[mm]	[kN]	[mm]	[mm]
M8	12x80	80	0,26	0,90	0,23	0,46	1,0	1,3	1,95
M8 / M10	16x85	85							
	16x130	130	1,14		1,03	2,06	2,3	2,5	3,75
M12 / M16	20x85	85	0,57		0,51	1,03			
	20x130	130	1,14	1,03	2,06				

Injection System VT-HP® for masonry**Performances calcium hollow brick KS L-12DF**

Characteristic values of resistance under tension and shear load (continue)

Displacements

Annex C14

Brick type: Clay solid brick Mz-DF**Table C34: Description of the brick**

Brick type	Clay solid brick Mz-DF	
Bulk density ρ [kg/dm ³]	1,6	
Compressive strength $f_b \geq$ [N/mm ²]	10, 20 or 28	
Code	EN 771-1	
Producer (country code)	e.g. Unipor (DE)	
Brick dimensions [mm]	240 x 115 x 55	
Drilling method	Hammer	

Table C35: Installation parameter

Anchor size		[-]	All sizes
Edge distance	c_{cr}	[mm]	$1,5 \cdot h_{ef}$
Minimum edge distance	c_{min}	[mm]	60
Spacing	s_{cr}	[mm]	$3 \cdot h_{ef}$
Minimum spacing	s_{min}	[mm]	120

Table C36: Group factor for anchor group in case of tension loading

Configuration		with $c \geq$	with $s \geq$			
II: anchors placed parallel to horizontal joint		60	120	$\alpha_{g,N,II}$	[-]	0,7
		$1,5 \cdot h_{ef}$	$3 \cdot h_{ef}$			2,0
⊥: anchors placed perpendicular to horizontal joint		60	120	$\alpha_{g,N,\perp}$	[-]	0,5
		$1,5 \cdot h_{ef}$	120			1,0
		$1,5 \cdot h_{ef}$	$3 \cdot h_{ef}$			2,0

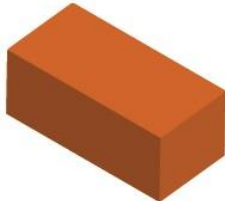
Table C37: Group factor for anchor group in case of shear loading parallel to free edge

Configuration		with $c \geq$	with $s \geq$			
II: anchors placed parallel to horizontal joint		60	120	$\alpha_{g,V,II}$	[-]	0,5
		90	120			1,1
		$1,5 \cdot h_{ef}$	$3 \cdot h_{ef}$			2,0
⊥: anchors placed perpendicular to horizontal joint		60	120	$\alpha_{g,V,\perp}$	[-]	0,5
		$1,5 \cdot h_{ef}$	120			1,0
		$1,5 \cdot h_{ef}$	$3 \cdot h_{ef}$			2,0

Table C38: Group factor for anchor group in case of shear loading perpendicular to free edge

Configuration		with $c \geq$	with $s \geq$			
II: anchors placed parallel to horizontal joint		60	120	$\alpha_{g,V,II}$	[-]	0,5
		$1,5 \cdot h_{ef}$	120			1,0
		$1,5 \cdot h_{ef}$	$3 \cdot h_{ef}$			2,0
⊥: anchors placed perpendicular to horizontal joint		60	120	$\alpha_{g,V,\perp}$	[-]	0,5
		$1,5 \cdot h_{ef}$	120			1,0
		$1,5 \cdot h_{ef}$	$3 \cdot h_{ef}$			2,0

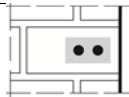
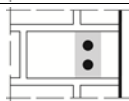
Injection System VT-HP® for masonry**Performances clay solid brick Mz-DF**

Description of the brick
Installation parameters

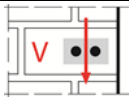
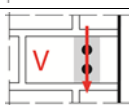
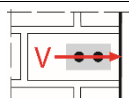
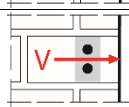
Annex C15

Brick type: Clay solid brick Mz-DF						
Table C39: Characteristic values of resistance under tension and shear loads						
Anchor size	Sleeve	Effective anchorage depth	Characteristic resistance			
			Use category			
			d/d w/d w/w			d/d w/d w/w
			40°C/24°C	80°C/50°C	120°C/72°C	For all temperature range
h_{ef}		$N_{Rk,b} = N_{Rk,p}^{1)}$			$V_{Rk,b}^{2)3)}$	
[mm]		[kN]				
Compressive strength $f_b \geq 10 \text{ N/mm}^2$						
M8	-	80	3,5 (1,5)	3,5 (1,5)	2,5 (1,2)	3,5 (1,2)
M10	-	90	3,5 (1,5)	3,5 (1,5)	3,0 (1,5)	3,5 (1,2)
M12	-	100	4,0 (2,0)	4,0 (2,0)	3,5 (1,5)	3,5 (1,2)
M16	-	100	4,0 (2,0)	4,0 (2,0)	3,5 (1,5)	5,5 (1,5)
M8	12x80	80	3,5 (1,5)	3,5 (1,5)	3,0 (1,2)	3,5 (1,2)
M8 / M10	16x85	85	3,5 (1,5)	3,5 (1,5)	3,0 (1,5)	3,5 (1,2)
	16x130	130	3,5 (1,5)	3,5 (1,5)	3,0 (1,5)	3,5 (1,2)
M12 / M16	20x85	85	3,5 (1,5)	3,5 (1,5)	3,0 (1,5)	3,5 (1,2)
	20x130	130	3,5 (1,5)	3,5 (1,5)	3,0 (1,5)	3,5 (1,2)
	20x200	200	3,5 (1,5)	3,5 (1,5)	3,0 (1,5)	3,5 (1,2)
Compressive strength $f_b \geq 20 \text{ N/mm}^2$						
M8	-	80	4,5 (2,5)	4,5 (2,5)	4,0 (2,0)	5,0 (1,5)
M10	-	90	5,5 (2,5)	5,5 (2,5)	4,5 (2,0)	5,0 (1,5)
M12	-	100	6,0 (3,0)	6,0 (3,0)	5,0 (2,5)	5,0 (1,5)
M16	-	100	6,0 (3,0)	6,0 (3,0)	5,0 (2,5)	8,0 (2,5)
M8	12x80	80	4,5 (2,5)	4,5 (2,5)	4,0 (2,0)	5,0 (1,5)
M8 / M10	16x85	85	5,0 (2,5)	5,0 (2,5)	4,0 (2,0)	5,0 (1,5)
	16x130	130	5,0 (2,5)	5,0 (2,5)	4,0 (2,0)	5,0 (1,5)
M12 / M16	20x85	85	5,0 (2,5)	5,0 (2,5)	4,0 (2,0)	5,0 (1,5)
	20x130	130	5,0 (2,5)	5,0 (2,5)	4,0 (2,0)	5,0 (1,5)
	20x200	200	5,0 (2,5)	5,0 (2,5)	4,0 (2,0)	5,0 (1,5)
Compressive strength $f_b \geq 28 \text{ N/mm}^2$						
M8	-	80	5,5 (2,5)	5,5 (2,5)	4,5 (2,5)	5,5 (2,0)
M10	-	90	6,0 (3,0)	6,0 (3,0)	5,0 (2,5)	5,5 (2,0)
M12	-	100	7,0 (3,5)	7,0 (3,5)	6,0 (3,0)	5,5 (2,0)
M16	-	100	7,0 (3,5)	7,0 (3,5)	6,0 (3,0)	9,0 (3,0)
M8	12x80	80	5,5 (2,5)	5,5 (2,5)	4,5 (2,5)	5,5 (2,0)
M8 / M10	16x85	85	6,0 (3,0)	6,0 (3,0)	5,0 (2,5)	5,5 (2,0)
	16x130	130	6,0 (3,0)	6,0 (3,0)	5,0 (2,5)	5,5 (2,0)
M12 / M16	20x85	85	6,0 (3,0)	6,0 (3,0)	5,0 (2,5)	5,5 (2,0)
	20x130	130	6,0 (3,0)	6,0 (3,0)	5,0 (2,5)	5,5 (2,0)
	20x200	200	6,0 (3,0)	6,0 (3,0)	5,0 (2,5)	5,5 (2,0)
¹⁾ Values are valid for c_{cr} , values in brackets are valid for single anchors with c_{min} ²⁾ For c_{cr} calculation of $V_{Rk,c}$ see ETAG 029, Annex C; for c_{min} values in brackets $V_{Rk,b} = V_{Rk,c}$ ³⁾ The values are valid for steel 5.6 or greater. For steel 4.6 and 4.8 multiply $V_{Rk,b}$ by 0,8						
Injection System VT-HP® for masonry					Annex C16	
Performances clay solid brick Mz-DF Characteristic values of resistance under tension and shear load						

Brick type: Clay solid brick Mz-DF**Table C40: Displacements**

Anchor size	Sleeve	Effective anchorage depth h_{ef}	N	δ_N / N	δ_{N0}	$\delta_{N\infty}$	V	δ_{v0}	$\delta_{v\infty}$
		[mm]	[kN]	[mm/kN]	[mm]	[mm]	[kN]	[mm]	[mm]
M8	-	80	1,3	0,15	0,19	0,39	1,9	1,00	1,50
M10	-	90	1,6		0,24	0,47			
M12	-	100	1,7		0,26	0,51			
M16	-	100							
M8	12x80	80	1,3		0,19	0,39	1,9		
M8 / M10	16x85	85							
	16x130	130							
M12 / M16	20x85	85							
	20x130	130							
	20x200	200							

Injection System VT-HP® for masonry

Performances clay solid brick Mz-DF
Displacements**Annex C17**

Brick type: Clay hollow brick HLz-16-DF

Table C41: Description of the brick

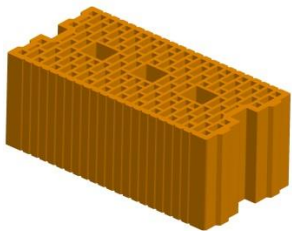
Brick type	Clay hollow brick HLz-16-DF	
Bulk density ρ [kg/dm ³]	0,8	
Compressive strength $f_b \geq$ [N/mm ²]	6, 8, 12, 14	
Code	EN 771-1	
Producer (country code)	e.g. Unipor (DE)	
Brick dimensions [mm]	497 x 240 x 238	
Drilling method	Rotary	

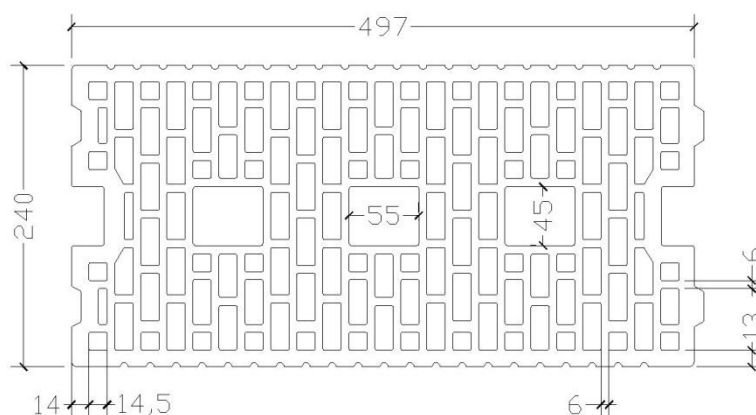



Table C42: Installation parameters

Anchor size		[-]	All sizes
Edge distance	c_{cr}	[mm]	100 (120) ¹⁾
Minimum edge distance	$c_{min}^{2)}$	[mm]	100 (120) ¹⁾
Spacing	$s_{cr, }$	[mm]	497
	$s_{cr,\perp}$	[mm]	238
Minimum spacing	s_{min}	[mm]	100

1) Value in brackets for sleeves 20x85; 20x130 and 20x200

2) For $V_{Rk,c}$: c_{min} according to ETAG 029, Annex C

Table C43: Group factor for anchor group in case of tension loading

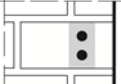
Configuration		with $c \geq$	with $s \geq$			
: anchors placed parallel to horizontal joint		c_{cr}	100	$\alpha_{g,N, }$	[-]	1,3
		c_{cr}	497			2,0
⊥: anchors placed perpendicular to horizontal joint		c_{cr}	100	$\alpha_{g,N,\perp}$		1,1
		c_{cr}	238			2,0

Injection System VT-HP® for masonry

Performances clay hollow brick HLz-16DF

Description of the brick

Installation parameters

Annex C18

Brick type: Clay hollow brick HLz-16-DF**Table C44: Group factor for anchor group in case of shear loading parallel to free edge**



Configuration		with $c \geq$	with $s \geq$			
: anchors placed parallel to horizontal joint		C_{cr}	497	$\alpha_{g,V, }$	[-]	2,0
⊥: anchors placed perpendicular to horizontal joint		C_{cr}	238	$\alpha_{g,V,\perp}$		2,0

Table C45: Group factor for anchor group in case of shear loading perpendicular to free edge

Configuration		with $c \geq$	with $s \geq$			
: anchors placed parallel to horizontal joint		C_{cr}	497	$\alpha_{g,V, }$	[-]	2,0
⊥: anchors placed perpendicular to horizontal joint		C_{cr}	238	$\alpha_{g,V,\perp}$		2,0

Table C46: Characteristic values of resistance under tension and shear loads

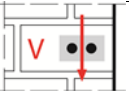
Anchor size	Sleeve	Effective anchorage depth	Characteristic resistance			
			Use category			
			d/d w/d w/w			d/d w/d w/w
			40°C/24°C	80°C/50°C	120°C/72°C	For all temperature range
		h_{ef}	$N_{Rk,b} = N_{Rk,p}^{1)}$			$V_{Rk,b}^{2)3)}$
		[mm]	[kN]			
Compressive strength $f_b \geq 6 \text{ N/mm}^2$						
M8	12x80	80	2,5	2,5	2,0	2,5
M8 / M10	16x85	85	2,5	2,5	2,0	4,5
	16x130	130	3,5	3,5	3,0	4,5
M12 / M16	20x85	85	2,5	2,5	2,0	5,0
	20x130	130	3,5	3,5	3,0	6,0
	20x200	200	3,5	3,5	3,0	6,0
Compressive strength $f_b \geq 8 \text{ N/mm}^2$						
M8	12x80	80	3,0	3,0	2,5	3,0
M8 / M10	16x85	85	3,0	3,0	2,5	5,5
	16x130	130	4,5	4,5	3,5	5,5
M12 / M16	20x85	85	3,0	3,0	2,5	6,0
	20x130	130	4,5	4,5	3,5	7,0
	20x200	200	4,5	4,5	3,5	7,0

1) Values are valid for C_{cr} and C_{min}

2) Calculation of $V_{Rk,c}$ see ETAG 029, Annex C, except for shear load parallel to free edge with $c \geq 125 \text{ mm}$: $V_{Rk,c,||} = V_{Rk,b}$

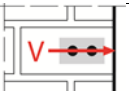
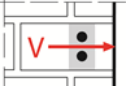
3) The values are valid for steel 5.6 or greater. For steel 4.6 and 4.8 multiply $V_{Rk,b}$ by 0,8

Injection System VT-HP® for masonry

Performances clay hollow brick HLz-16DF

Installation parameters (continue)

Characteristic values of resistance under tension and shear load

Annex C19

Brick type: Clay hollow brick HLz-16-DF**Table C47: Characteristic values of resistance under tension and shear loads (continue)**

Anchor size	Sleeve	Effective anchorage depth	Characteristic resistance			
			Use category			
			d/d w/d w/w			d/d w/d w/w
			40°C/24°C	80°C/50°C	120°C/72°C	For all temperature range
h _{ef}		N _{Rk,b} = N _{Rk,p} ¹⁾			V _{Rk,b} ²⁾³⁾	
[mm]		[kN]				
Compressive strength f_b ≥ 12 N/mm²						
M8	12x80	80	3,5	3,5	3,0	4,0
M8 / M10	16x85	85	3,5	3,5	3,0	6,5
	16x130	130	5,0	5,0	4,5	6,5
M12 / M16	20x85	85	3,5	3,5	3,0	7,0
	20x130	130	5,0	5,0	4,5	9,0
	20x200	200	5,0	5,0	4,5	9,0
Compressive strength f_b ≥ 14 N/mm²						
M8	12x80	80	4,0	4,0	3,0	4,0
M8 / M10	16x85	85	4,0	4,0	3,0	6,5
	16x130	130	5,5	5,5	4,5	6,5
M12 / M16	20x85	85	4,0	4,0	3,0	7,0
	20x130	130	5,5	5,5	4,5	9,0
	20x200	200	5,5	5,5	4,5	9,0

1) Values are valid for c_{cr} and c_{min}

2) Calculation of V_{Rk,c} see ETAG 029, Annex C, except for shear load parallel to free edge with c ≥ 125 mm: V_{Rk,c,II} = V_{Rk,b}

3) The values are valid for steel 5.6 or greater. For steel 4.6 and 4.8 multiply V_{Rk,b} by 0,8

Table C48: Displacements

Anchor size	Sleeve	Effective anchorage depth h _{ef}	N	δ _N / N	δ _{N0}	δ _{N∞}	V	δ _{v0}	δ _{v∞}
M8	12x80	80	1,14	0,10	0,11	0,23	1,10	1,20	1,80
M8 / M10	16x85	85							
	16x130	130	1,57		0,16	0,31	1,86	1,50	2,25
M12 / M16	20x85	85	1,14		0,11	0,23	1,86	1,50	2,25
	20x130	130	1,57		0,16	0,31	2,57	2,10	3,15
	20x200	200							

Injection System VT-HP® for masonry

Performances clay hollow brick HLz-16DF

Characteristic values of resistance under tension and shear load (continue)

Displacements

Annex C20

Brick type: Clay hollow brick Porotherm Homebric

Table C49: Description of the brick

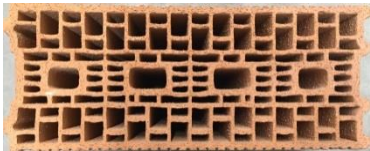
Brick type	Clay hollow hollow brick Porotherm Homebric	
Bulk density ρ [kg/dm ³]	0,7	
Compressive strength $f_b \geq$ [N/mm ²]	4, 6 or 10	
Code	EN 771-1	
Producer (country code)	e.g. Wienerberger (FR)	
Brick dimensions [mm]	500 x 200 x 299	
Drilling method	Rotary	

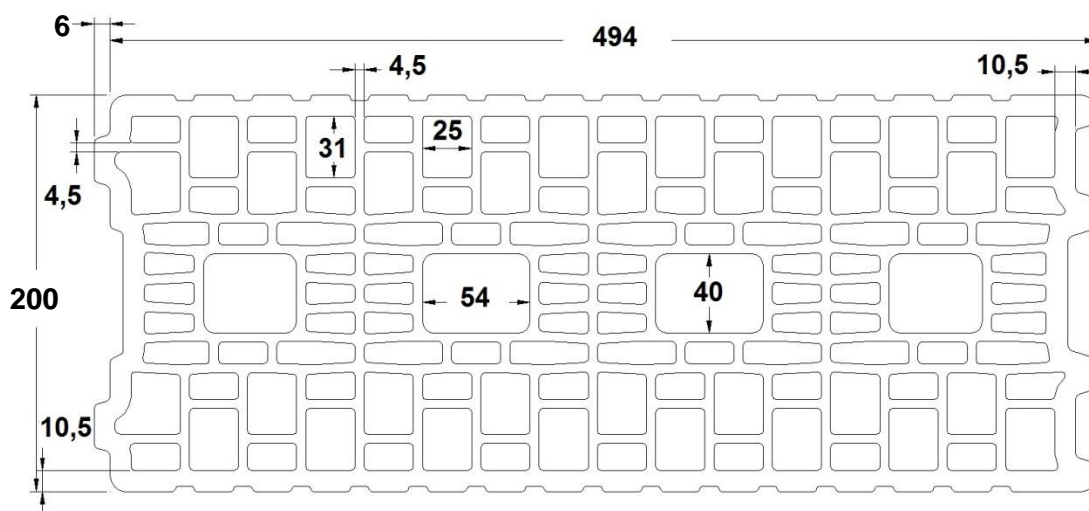

Table C50: Installation parameters

Anchor size		[-]	All sizes
Edge distance	C_{cr}	[mm]	100 (120) ¹⁾
Minimum edge distance	$C_{min}^{2)}$	[mm]	100 (120) ¹⁾
Spacing	$S_{cr, }$	[mm]	500
	$S_{cr,\perp}$	[mm]	299
Minimum spacing	S_{min}	[mm]	100

1) Value in brackets for sleeves 20x85 and 20x130

2) For $V_{Rk,c}$: C_{min} according to ETAG 029, Annex C

Table C51: Group factor for anchor group in case of tension loading

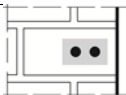
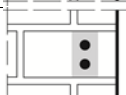
Configuration		with $c \geq$	with $s \geq$			
: anchors placed parallel to horizontal joint		200	100	$\alpha_{g,N, }$	[-]	2,0
		C_{cr}	500			2,0
⊥: anchors placed perpendicular to horizontal joint		200	100	$\alpha_{g,N,\perp}$		1,2
		C_{cr}	299			2,0

Injection System VT-HP® for masonry

Performances clay hollow brick Porotherm Homebric

Description of the brick
Installation parameters

Annex C21

Brick type: Clay silicate hollow brick Porotherm Homebric**Table C52: Group factor for anchor group in case of shear loading parallel to free edge**



Configuration		with $c \geq$	with $s \geq$			
II: anchors placed parallel to horizontal joint		C_{cr}	500	$\alpha_{g,V,II}$	[-]	2,0
I: anchors placed perpendicular to horizontal joint		C_{cr}	299	$\alpha_{g,V,I}$		2,0

Table C53: Group factor for anchor group in case of shear loading perpendicular to free edge

Configuration		with $c \geq$	with $s \geq$			
II: anchors placed parallel to horizontal joint		C_{cr}	500	$\alpha_{g,V,II}$	[-]	2,0
I: anchors placed perpendicular to horizontal joint		C_{cr}	299	$\alpha_{g,V,I}$		2,0

Table C54: Characteristic values of resistance under tension and shear loads

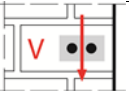
Anchor size	Sleeve	Effective anchorage depth	Characteristic resistance			
			Use category			
			d/d w/d w/w			d/d w/d w/w
			40°C/24°C	80°C/50°C	120°C/72°C	For all temperature range
h_{ef}	$N_{Rk,b} = N_{Rk,p}^{1)}$			$V_{Rk,b}^{2)3)}$		
		[mm]	[kN]			
Compressive strength $f_b \geq 4 \text{ N/mm}^2$						
M8	12x80	80	0,9	0,9	0,75	2,0
M8 / M10	16x85	85	0,9	0,9	0,75	2,0
	16x130	130	1,2	1,2	0,9	2,0
M12 / M16	20x85	85	0,9	0,9	0,75	2,5
	20x130	130	1,2	1,2	0,9	2,5
Compressive strength $f_b \geq 6 \text{ N/mm}^2$						
M8	12x80	80	0,9	0,9	0,9	2,5
M8 / M10	16x85	85	0,9	0,9	0,9	2,5
	16x130	130	1,2	1,2	1,2	2,5
M12 / M16	20x85	85	0,9	0,9	0,9	3,0
	20x130	130	1,2	1,2	1,2	3,0

1) Values are valid for C_{cr} and C_{min}

2) Calculation of $V_{Rk,c}$ see ETAG 029, Annex C, except for shear load parallel to free edge with $c \geq 200 \text{ mm}$: $V_{Rk,c,II} = V_{Rk,b}$

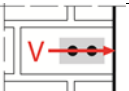
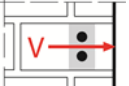
3) The values are valid for steel 5.6 or greater. For steel 4.6 and 4.8 multiply $V_{Rk,b}$ by 0,8

Injection System VT-HP® for masonry

Performances clay hollow brick Porotherm Homebric

Installation parameters (continue)

Characteristic values of resistance under tension and shear load

Annex C22

Brick type: Clay silicate hollow brick Porotherm Homebric**Table C55: Characteristic values of resistance under tension and shear loads (continue)**

Anchor size	Sleeve	Effective anchorage depth	Characteristic resistance			
			Use category			
			d/d w/d w/w			d/d w/d w/w
			40°C/24°C	80°C/50°C	120°C/72°C	For all temperature range
h_{ef}		$N_{Rk,b} = N_{Rk,p}^{1)}$			$V_{Rk,b}^{2)3)}$	
[mm]		[kN]				
Compressive strength $f_b \geq 10 \text{ N/mm}^2$						
M8	12x80	80	1,2	1,2	1,2	3,0
M8 / M10	16x85	85	1,2	1,2	1,2	3,0
	16x130	130	1,5	1,5	1,5	3,5
M12 / M16	20x85	85	1,2	1,2	1,2	4,0
	20x130	130	1,5	1,5	1,5	4,0

1) Values are valid for c_{cr} and c_{min} 2) Calculation of $V_{Rk,c}$ see ETAG 029, Annex C, except for shear load parallel to free edge with $c \geq 200 \text{ mm}$: $V_{Rk,c,II} = V_{Rk,b}$ 3) The values are valid for steel 5.6 or greater. For steel 4.6 and 4.8 multiply $V_{Rk,b}$ by 0,8**Table C56: Displacements**

Anchor size	Sleeve	Effective anchorage depth h_{ef}	N	δ_N / N	δ_{N0}	$\delta_{N\infty}$	V	δ_{V0}	$\delta_{V\infty}$
		[mm]	[kN]	[mm/kN]	[mm]	[mm]	[kN]	[mm]	[mm]
M8	12x80	80	0,34	0,80	0,27	0,55	0,9	1,20	1,80
M8 / M10	16x85	85					0,9		
	16x130	130	0,43		0,34	0,69	1,0		
M12 / M16	20x85	85	0,34		0,27	0,55	1,14		
	20x130	130	0,43		0,34	0,69			

Injection System VT-HP® for masonry

Performances clay hollow brick Porotherm Homebric

Characteristic values of resistance under tension and shear load (continue)

Displacements

Annex C23

Brick type: Clay hollow brick BGV Thermo

Table C57: Description of the brick

Brick type	Clay hollow brick BGV Thermo	
Bulk density ρ [kg/dm ³]	0,6	
Compressive strength $f_b \geq$ [N/mm ²]	4, 6 or 10	
Code	EN 771-1	
Producer (country code)	e.g. Leroux (FR)	
Brick dimensions [mm]	500 x 200 x 314	
Drilling method	Rotary	

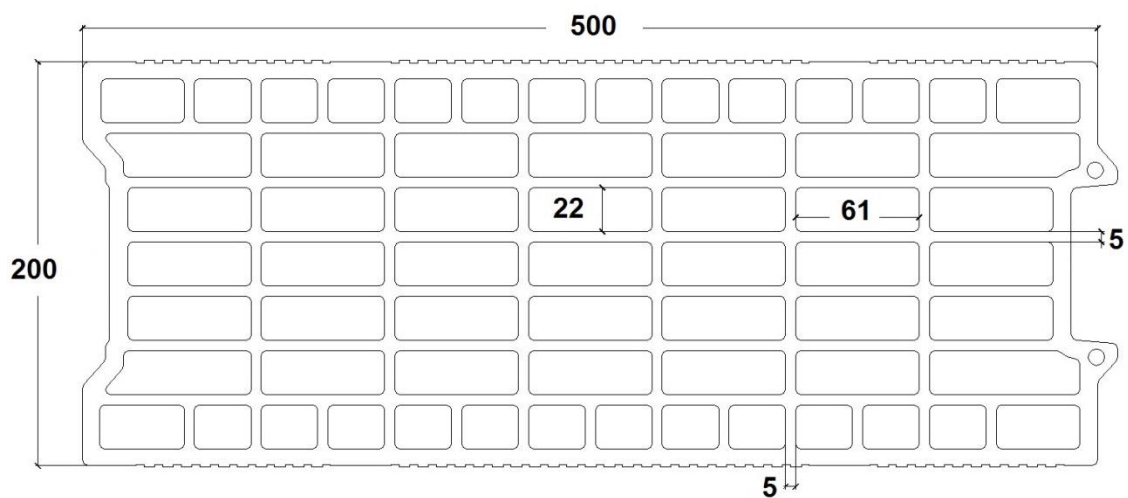

Table C58: Installation parameters

Anchor size		[-]	All sizes
Edge distance	C_{cr}	[mm]	100 (120) ¹⁾
Minimum edge distance	$C_{min}^{2)}$	[mm]	100 (120) ¹⁾
Spacing	$S_{cr, }$	[mm]	500
	$S_{cr,\perp}$	[mm]	314
Minimum spacing	S_{min}	[mm]	100

¹⁾ Value in brackets for sleeves 20x85 and 20x130

²⁾ For $V_{Rk,c}$: C_{min} according to ETAG 029, Annex C

Table C59: Group factor for anchor group in case of tension loading

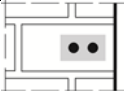
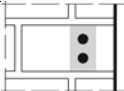
Configuration		with $c \geq$	with $s \geq$			
: anchors placed parallel to horizontal joint		200	100	$\alpha_{g,N, }$	[-]	1,7
		C_{cr}	500			2,0
\perp : anchors placed perpendicular to horizontal joint		200	100	$\alpha_{g,N,\perp}$	[-]	1,1
		C_{cr}	314			2,0

Injection System VT-HP® for masonry

Performances clay hollow brick BGV Thermo

Description of the brick
Installation parameters

Annex C24

Brick type: Clay hollow brick BGV Thermo

Table C60: Group factor for anchor group in case of shear loading parallel to free edge

Configuration		with $c \geq$	with $s \geq$			
II: anchors placed parallel to horizontal joint		C_{cr}	500	$\alpha_{g,V,II}$	[-]	2,0
I: anchors placed perpendicular to horizontal joint		C_{cr}	314	$\alpha_{g,V,I}$		2,0

Table C61: Group factor for anchor group in case of shear loading perpendicular to free edge

Configuration		with $c \geq$	with $s \geq$			
II: anchors placed parallel to horizontal joint		C_{cr}	500	$\alpha_{g,V,II}$	[-]	2,0
I: anchors placed perpendicular to horizontal joint		C_{cr}	314	$\alpha_{g,V,I}$		2,0

Injection System VT-HP® for masonry

Performances clay hollow brick BGV Thermo
Installation parameters (continue)

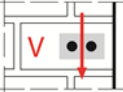
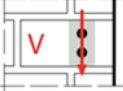
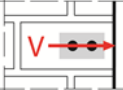
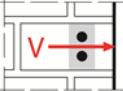
Annex C25

Brick type: Clay hollow brick BGV Thermo**Table C62: Characteristic values of resistance under tension and shear loads**

Anchor size	Sleeve	Effective anchorage depth	Characteristic resistance			
			Use category			
			d/d w/d w/w			d/d w/d w/w
			40°C/24°C	80°C/50°C	120°C/72°C	For all temperature range
h_{ef}	$N_{Rk,b} = N_{Rk,p}^{1)}$			$V_{Rk,b}^{2)3)}$		
[mm]	[kN]					
Compressive strength $f_b \geq 4 \text{ N/mm}^2$						
M8	12x80	80	0,6	0,6	0,6	2,0
M8 / M10	16x85	85	0,6	0,6	0,6	2,0
	16x130	130	1,2	1,2	0,9	2,5
M12 / M16	20x85	85	0,6	0,6	0,6	2,5
	20x130	130	1,2	1,2	0,9	2,5
Compressive strength $f_b \geq 6 \text{ N/mm}^2$						
M8	12x80	80	0,9	0,9	0,75	2,5
M8 / M10	16x85	85	0,9	0,9	0,75	2,5
	16x130	130	1,5	1,5	1,2	3,0
M12 / M16	20x85	85	0,9	0,9	0,75	3,0
	20x130	130	1,5	1,5	1,2	3,0
Compressive strength $f_b \geq 10 \text{ N/mm}^2$						
M8	12x80	80	0,9	0,9	0,9	3,5
M8 / M10	16x85	85	0,9	0,9	0,9	3,5
	16x130	130	2,0	2,0	1,5	4,0
M12 / M16	20x85	85	0,9	0,9	0,9	4,0
	20x130	130	2,0	2,0	1,5	4,0

1) Values are valid for c_{cr} and c_{min} 2) Calculation of $V_{Rk,c}$ see ETAG 029, Annex C, except for shear load parallel to free edge with $c \geq 250 \text{ mm}$: $V_{Rk,c,II} = V_{Rk,b}$ 3) The values are valid for steel 5.6 or greater. For steel 4.6 and 4.8 multiply $V_{Rk,b}$ by 0,8**Table C63: Displacements**

Anchor size	Sleeve	Effective anchorage depth h_{ef}	N	δ_N / N	δ_{N0}	$\delta_{N\infty}$	V	δ_{V0}	$\delta_{V\infty}$
			[kN]	[mm/kN]	[mm]	[mm]	[kN]	[mm]	[mm]
M8	12x80	80	0,26	0,80	0,21	0,41	0,7	1,00	1,50
M8 / M10	16x85	85							
	16x130	130	0,43		0,34	0,69	0,86		
M12 / M16	20x85	85	0,26		0,21	0,41			
	20x130	130	0,43	0,34	0,69				

Injection System VT-HP® for masonry**Performances clay hollow brick BGV Thermo**

Characteristic values of resistance under tension and shear load

Displacements

Annex C26

Brick type: Clay hollow brick Calibric R+

Table C64: Description of the brick

Brick type	Clay hollow brick Calibric R+	
Bulk density ρ [kg/dm ³]	0,6	
Compressive strength $f_b \geq$ [N/mm ²]	6, 9 or 12	
Code	EN 771-1	
Producer (country code)	e.g. Terreal (FR)	
Brick dimensions [mm]	500 x 200 x 314	
Drilling method	Rotary	

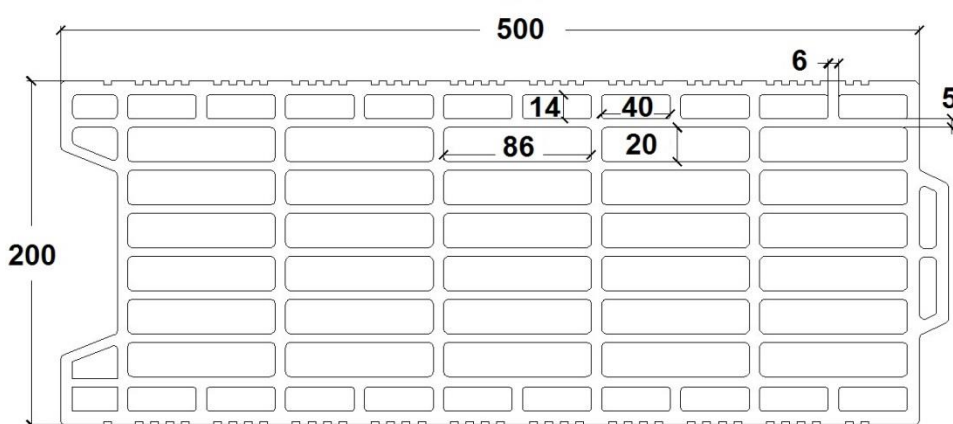



Table C65: Installation parameters

Anchor size		[-]	All sizes
Edge distance	c_{cr}	[mm]	100 (120) ¹⁾
Minimum edge distance	$c_{min}^{2)}$	[mm]	100 (120) ¹⁾
Spacing	$s_{cr, }$	[mm]	500
	$s_{cr,\perp}$	[mm]	314
Minimum spacing	s_{min}	[mm]	100

1) Value in brackets for sleeves 20x85 and 20x130

2) For $V_{Rk,c}$: c_{min} according to ETAG 029, Annex C

Table C66: Group factor for anchor group in case of tension loading

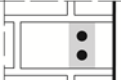
Configuration		with $c \geq$	with $s \geq$			
: anchors placed parallel to horizontal joint		175	100	$\alpha_{g,N, }$	[-]	1,7
		c_{cr}	500			2,0
⊥: anchors placed perpendicular to horizontal joint		175	100	$\alpha_{g,N,\perp}$		1,0
		c_{cr}	314			2,0

Injection System VT-HP® for masonry

Performances clay hollow brick Calibric R+

Description of the brick
Installation parameters

Annex C27

Brick type: Clay hollow brick Calibric R+**Table C67: Group factor for anchor group in case of shear loading parallel to free edge**



Configuration		with $c \geq$	with $s \geq$			
: anchors placed parallel to horizontal joint		C_{cr}	500	$\alpha_{g,V, }$	[-]	2,0
⊥: anchors placed perpendicular to horizontal joint		C_{cr}	314	$\alpha_{g,V,\perp}$		2,0

Table C68: Group factor for anchor group in case of shear loading perpendicular to free edge

Configuration		with $c \geq$	with $s \geq$			
: anchors placed parallel to horizontal joint		C_{cr}	500	$\alpha_{g,V, }$	[-]	2,0
⊥: anchors placed perpendicular to horizontal joint		C_{cr}	314	$\alpha_{g,V,\perp}$		2,0

Table C69: Characteristic values of resistance under tension and shear loads

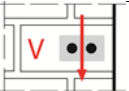
Anchor size	Sleeve	Effective anchorage depth	Characteristic resistance			
			Use category			
			d/d w/d w/w			d/d w/d w/w
			40°C/24°C	80°C/50°C	120°C/72°C	For all temperature range
		h_{ef}	$N_{Rk,b} = N_{Rk,p}^{1)}$			$V_{Rk,b}^{2)3)}$
		[mm]	[kN]			
Compressive strength $f_b \geq 6 \text{ N/mm}^2$						
M8	12x80	80	0,9	0,9	0,75	3,0
M8 / M10	16x85	85	0,9	0,9	0,75	4,0
	16x130	130	1,2	1,2	0,9	4,0
M12 / M16	20x85	85	0,9	0,9	0,75	6,0
	20x130	130	1,2	1,2	0,9	6,0
Compressive strength $f_b \geq 9 \text{ N/mm}^2$						
M8	12x80	80	1,2	1,2	0,9	3,5
M8 / M10/ IG-M6	16x85	85	1,2	1,2	0,9	5,0
	16x130	130	1,5	1,5	1,2	5,0
M12 / M16	20x85	85	1,2	1,2	0,9	7,5
	20x130	130	1,5	1,5	1,2	7,5

1) Values are valid for C_{cr} and C_{min}

2) Calculation of $V_{Rk,c}$ see ETAG 029, Annex C, except for shear load parallel to free edge with $c \geq 250 \text{ mm}$: $V_{Rk,c,||} = V_{Rk,b}$

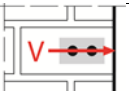
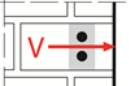
3) The values are valid for steel 5.6 or greater. For steel 4.6 and 4.8 multiply $V_{Rk,b}$ by 0,8

Injection System VT-HP® for masonry

Performances clay hollow brick Calibric R+

Installation parameters (continue)

Characteristic values of resistance under tension and shear load

Annex C28

Brick type: Clay hollow brick Calibric R+**Table C70: Characteristic values of resistance under tension and shear loads (continue)**

Anchor size	Sleeve	Effective anchorage depth	Characteristic resistance			
			Use category			
			d/d w/d w/w			d/d w/d w/w
			40°C/24°C	80°C/50°C	120°C/72°C	For all temperature range
h_{ef}		$N_{Rk,b} = N_{Rk,p}^{1)}$			$V_{Rk,b}^{2)3)}$	
[mm]		[kN]				
Compressive strength $f_b \geq 12 \text{ N/mm}^2$						
M8	12x80	80	1,2	1,2	0,9	4,0
M8 / M10	16x85	85	1,2	1,2	0,9	5,5
	16x130	130	1,5	1,5	1,2	5,5
M12 / M16	20x85	85	1,2	1,2	0,9	8,5
	20x130	130	1,5	1,5	1,2	8,5

1) Values are valid for c_{cr} and c_{min} 2) Calculation of $V_{Rk,c}$ see ETAG 029, Annex C, except for shear load parallel to free edge with $c \geq 250 \text{ mm}$: $V_{Rk,c,II} = V_{Rk,b}$ 3) The values are valid for steel 5.6 or greater. For steel 4.6 and 4.8 multiply $V_{Rk,b}$ by 0,8**Table C71: Displacements**

Anchor size	Sleeve	Effective anchorage depth h_{ef}	N	δ_N / N	δ_{N0}	$\delta_{N\infty}$	V	δ_{V0}	$\delta_{V\infty}$
M8	12x80	80	0,34	0,80	0,27	0,55	1,0	1,10	1,65
M8 / M10	16x85	85							
	16x130	130	0,43		0,34	0,69	1,43	2,00	3,00
M12 / M16	20x85	85	0,34		0,27	0,55	2,14		
	20x130	130	0,43	0,34	0,69				

Injection System VT-HP® for masonry**Performances clay hollow brick Calibric R+**

Characteristic values of resistance under tension and shear load (continue)

Displacements

Annex C29

Brick type: Clay hollow brick Urbanbric

Table C72: Description of the brick

Brick type	Clay hollow brick Urbanbric		
Bulk density ρ [kg/dm ³]	0,7		
Compressive strength $f_b \geq$ [N/mm ²]	6, 9 or 12		
Code	EN 771-1		
Producer (country code)	e.g. Imerys (FR)		
Brick dimensions [mm]	560 x 200 x 274		
Drilling method	Rotary		

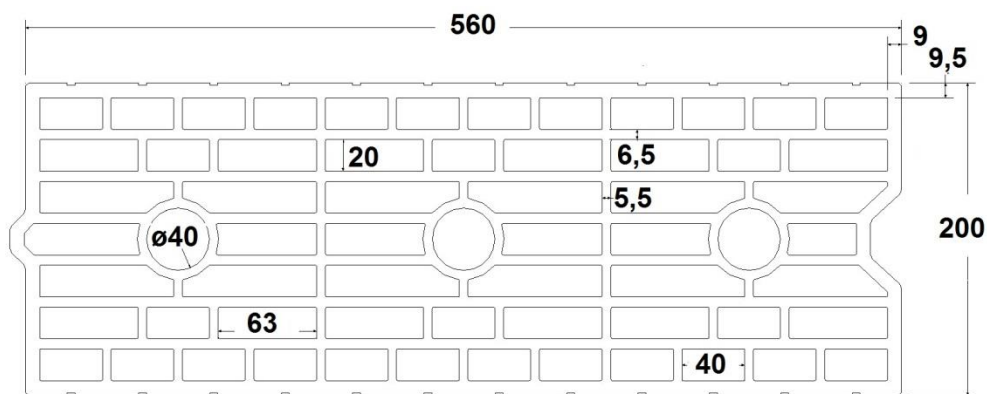

Table C73: Installation parameters

Anchor size		[-]	All sizes
Edge distance	C_{cr}	[mm]	100 (120) ¹⁾
Minimum edge distance	$C_{min}^{2)}$	[mm]	100 (120) ¹⁾
Spacing	$S_{cr,II}$	[mm]	560
	$S_{cr,\perp}$	[mm]	274
Minimum spacing	S_{min}	[mm]	100

¹⁾ Value in brackets for sleeves 20x85 and 20x130

²⁾ For $V_{Rk,c}$: C_{min} according to ETAG 029, Annex C

Table C74: Group factor for anchor group in case of tension loading

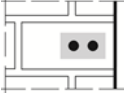
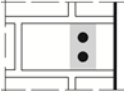
Configuration		with $c \geq$	with $s \geq$			
II: anchors placed parallel to horizontal joint		185	100	$\alpha_{g,N,II}$	[-]	1,9
		C_{cr}	560			2,0
\perp : anchors placed perpendicular to horizontal joint		185	100	$\alpha_{g,N,\perp}$		1,1
		C_{cr}	274			2,0

Injection System VT-HP® for masonry

Performances clay hollow brick Urbanbric

Description of the brick
Installation parameters

Annex C30

Brick type: Clay hollow brick Urbanbric**Table C75: Group factor for anchor group in case of shear loading parallel to free edge**



Configuration		with $c \geq$	with $s \geq$			
II: anchors placed parallel to horizontal joint		C_{cr}	560	$\alpha_{g,V,II}$	[-]	2,0
I: anchors placed perpendicular to horizontal joint		C_{cr}	274	$\alpha_{g,V,I}$		2,0

Table C76: Group factor for anchor group in case of shear loading perpendicular to free edge

Configuration		with $c \geq$	with $s \geq$			
II: anchors placed parallel to horizontal joint		C_{cr}	560	$\alpha_{g,V,II}$	[-]	2,0
I: anchors placed perpendicular to horizontal joint		C_{cr}	274	$\alpha_{g,V,I}$		2,0

Table C77: Characteristic values of resistance under tension and shear loads

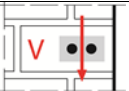
Anchor size	Sleeve	Effective anchorage depth	Characteristic resistance			
			Use category			
			d/d w/d w/w			d/d w/d w/w
			40°C/24°C	80°C/50°C	120°C/72°C	For all temperature range
		h_{ef}	$N_{Rk,b} = N_{Rk,p}^{1)}$			$V_{Rk,b}^{2)3)}$
		[mm]	[kN]			
Compressive strength $f_b \geq 6 \text{ N/mm}^2$						
M8	12x80	80	0,9	0,9	0,75	3,0
M8 / M10	16x85	85	0,9	0,9	0,75	3,0
	16x130	130	2,0	2,0	1,5	3,0
M12 / M16	20x85	85	0,9	0,9	0,75	3,5
	20x130	130	2,0	2,0	1,5	3,5
Compressive strength $f_b \geq 9 \text{ N/mm}^2$						
M8	12x80	80	0,9	0,9	0,9	4,0
M8 / M10	16x85	85	0,9	0,9	0,9	4,0
	16x130	130	2,5	2,5	2,0	4,0
M12 / M16	20x85	85	0,9	0,9	0,9	4,5
	20x130	130	2,5	2,5	2,0	4,5

1) Values are valid for C_{cr} and C_{min} 2) Calculation of $V_{Rk,c}$ see ETAG 029, Annex C, except for shear load parallel to free edge with $c \geq 190 \text{ mm}$: $V_{Rk,c,II} = V_{Rk,b}$ 3) The values are valid for steel 5.6 or greater. For steel 4.6 and 4.8 multiply $V_{Rk,b}$ by 0,8**Injection System VT-HP® for masonry****Performances clay hollow brick Urbanbric**

Installation parameters (continue)

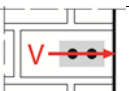
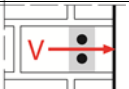
Characteristic values of resistance under tension and shear load

Annex C31

Brick type: Clay hollow brick Urbanbric**Table C78: Characteristic values of resistance under tension and shear loads (continue)**

Anchor size	Sleeve	Effective anchorage depth	Characteristic resistance			
			Use category			
			d/d w/d w/w			d/d w/d w/w
			40°C/24°C	80°C/50°C	120°C/72°C	For all temperature range
h_{ef}		$N_{Rk,b} = N_{Rk,p}^{1)}$			$V_{Rk,b}^{2)3)}$	
[mm]		[kN]				
Compressive strength $f_b \geq 12 \text{ N/mm}^2$						
M8	12x80	80	1,2	1,2	0,9	4,5
M8 / M10	16x85	85	1,2	1,2	0,9	4,5
	16x130	130	3,0	3,0	2,5	4,5
M12 / M16	20x85	85	1,2	1,2	0,9	5,0
	20x130	130	3,0	3,0	2,5	5,0

1) Values are valid for c_{cr} and c_{min}

2) Calculation of $V_{Rk,c}$ see ETAG 029, Annex C, except for shear load parallel to free edge with $c \geq 190 \text{ mm}$: $V_{Rk,c,II} = V_{Rk,b}$

3) The values are valid for steel 5.6 or greater. For steel 4.6 and 4.8 multiply $V_{Rk,b}$ by 0,8

Table C79: Displacements

Anchor size	Sleeve	Effective anchorage depth h_{ef}	N	δ_N / N	δ_{N0}	$\delta_{N\infty}$	V	δ_{V0}	$\delta_{V\infty}$
		[mm]	[kN]	[mm/kN]	[mm]	[mm]	[kN]	[mm]	[mm]
M8	12x80	80	0,34	0,80	0,27	0,55	1,30	1,00	1,50
M8 / M10	16x85	85							
	16x130	130	0,86		0,69	1,37			
M12 / M16	20x85	85	0,34		0,27	0,55	1,43		
	20x130	130	0,86		0,69	1,37			

Injection System VT-HP® for masonry**Performances clay hollow brick Urbanbric**

Characteristic values of resistance under tension and shear load (continue)

Displacements

Annex C32

Brick type: Clay hollow brick Brique creuse C40

Table C80: Description of the brick

Brick type	Clay hollow brick Brique creuse C40
Bulk density ρ [kg/dm ³]	0,7
Compressive strength $f_b \geq$ [N/mm ²]	4, 8 or 12
Code	EN 771-1
Producer (country code)	e.g. Terreal (FR)
Brick dimensions [mm]	500 x 200 x 200
Drilling method	Rotary

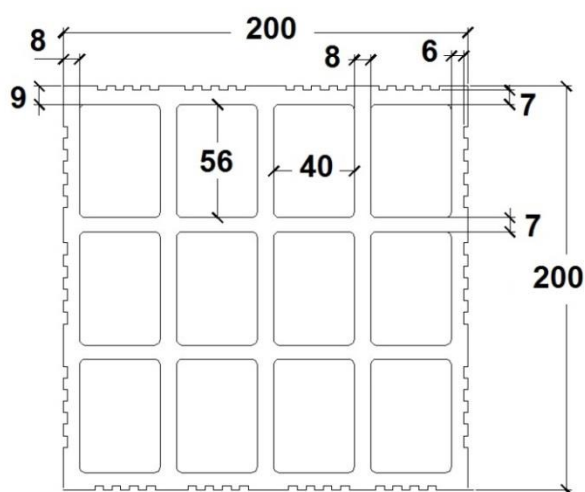

Table C81: Installation parameters

Anchor size		[-]	All sizes
Edge distance	C_{cr}	[mm]	100 (120) ¹⁾
Minimum edge distance	$C_{min}^{2)}$	[mm]	100 (120) ¹⁾
Spacing	$S_{cr,II}$	[mm]	500
	$S_{cr,\perp}$	[mm]	200
Minimum spacing	S_{min}	[mm]	200

¹⁾ Value in brackets for sleeves 20x85 and 20x130

²⁾ For $V_{Rk,c}$: C_{min} according to ETAG 029, Annex C

Table C82: Group factor for anchor group in case of tension loading

Configuration		with $c \geq$	with $s \geq$			
II: anchors placed parallel to horizontal joint		C_{cr}	200	$\alpha_{g,N,II}$	[-]	2,0
⊥: anchors placed perpendicular to horizontal joint		C_{cr}	200	$\alpha_{g,N,\perp}$		2,0

Injection System VT-HP® for masonry

Annex C33

Performances clay hollow brick Brique creuse C40

Description of the brick
Installation parameters

Brick type: Clay hollow brick Brique creuse C40**Table C83: Group factor for anchor group in case of shear loading parallel to free edge**



Configuration		with $c \geq$	with $s \geq$			
II: anchors placed parallel to horizontal joint		C_{cr}	500	$\alpha_{g,V,II}$	[-]	2,0
I: anchors placed perpendicular to horizontal joint		C_{cr}	200	$\alpha_{g,V,I}$		2,0

Table C84: Group factor for anchor group in case of shear loading perpendicular to free edge

Configuration		with $c \geq$	with $s \geq$			
II: anchors placed parallel to horizontal joint		C_{cr}	500	$\alpha_{g,V,II}$	[-]	2,0
I: anchors placed perpendicular to horizontal joint		C_{cr}	200	$\alpha_{g,V,I}$		2,0

Table C85: Characteristic values of resistance under tension and shear loads

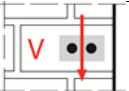
Anchor size	Sleeve	Effective anchorage depth	Characteristic resistance			
			Use category			
			d/d w/d w/w			d/d w/d w/w
			40°C/24°C	80°C/50°C	120°C/72°C	For all temperature range
		h_{ef}	$N_{Rk,b} = N_{Rk,p}^{1)}$			$V_{Rk,b}^{2)3)}$
		[mm]	[kN]			
Compressive strength $f_b \geq 4 \text{ N/mm}^2$						
M8	12x80	80	0,6	0,6	0,6	0,9
M8 / M10	16x85	85	0,6	0,6	0,6	0,9
	16x130	130	0,6	0,6	0,6	0,9
M12 / M16	20x85	85	0,6	0,6	0,6	0,9
	20x130	130	0,6	0,6	0,6	0,9
Compressive strength $f_b \geq 8 \text{ N/mm}^2$						
M8	12x80	80	0,9	0,9	0,75	1,2
M8 / M10	16x85	85	0,9	0,9	0,75	1,2
	16x130	130	0,9	0,9	0,75	1,2
M12 / M16	20x85	85	0,9	0,9	0,75	1,2
	20x130	130	0,9	0,9	0,75	1,2

1) Values are valid for C_{cr} and C_{min}

2) Calculation of $V_{Rk,c}$ see ETAG 029, Annex C

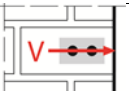
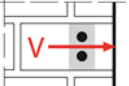
3) The values are valid for steel 5.6 or greater. For steel 4.6 and 4.8 multiply $V_{Rk,b}$ by 0,8

Injection System VT-HP® for masonry

Performances clay hollow brick Brique creuse C40

Installation parameters (continue)

Characteristic values of resistance under tension and shear load

Annex C34

Brick type: Clay hollow brick Brique creuse C40**Table C86: Characteristic values of resistance under tension and shear loads (continue)**

Anchor size	Sleeve	Effective anchorage depth	Characteristic resistance			
			Use category			
			d/d w/d w/w			d/d w/d w/w
			40°C/24°C	80°C/50°C	120°C/72°C	For all temperature range
h _{ef}		N _{Rk,b} = N _{Rk,p} ¹⁾			V _{Rk,b} ²⁾³⁾	
[mm]		[kN]				
Compressive strength f_b ≥ 12 N/mm²						
M8	12x80	80	1,2	1,2	0,9	1,5
M8 / M10	16x85	85	1,2	1,2	0,9	1,5
	16x130	130	1,2	1,2	0,9	1,5
M12 / M16	20x85	85	1,2	1,2	0,9	1,5
	20x130	130	1,2	1,2	0,9	1,5

1) Values are valid for C_{cr} and C_{min}2) Calculation of V_{Rk,c} see ETAG 029, Annex C3) The values are valid for steel 5.6 or greater. For steel 4.6 and 4.8 multiply V_{Rk,b} by 0,8**Table C87: Displacements**

Anchor size	Sleeve	Effective anchorage depth h _{ef}	N	δ _N / N	δ _{N0}	δ _{N∞}	V	δ _{v0}	δ _{v∞}
		[mm]	[kN]	[mm/kN]	[mm]	[mm]	[kN]	[mm]	[mm]
M8	12x80	80	0,17	0,80	0,14	0,27	0,3	0,9	1,35
M8 / M10	16x85	85							
	16x130	130	0,14		0,11	0,23			
M12 / M16	20x85	85	0,17		0,14	0,27			
	20x130	130	0,14		0,11	0,23			

Injection System VT-HP® for masonry**Annex C35****Performances clay hollow brick Brique creuse C40**

Characteristic values of resistance under tension and shear load (continue)

Displacements

Brick type: Clay hollow brick Blocchi Leggeri

Table C88: Description of the brick

Brick type	Clay hollow brick Blocchi Leggeri	
Bulk density ρ [kg/dm ³]	0,6	
Compressive strength $f_b \geq$ [N/mm ²]	4, 6, 8 or 12	
Code	EN 771-1	
Producer (country code)	e.g. Wienerberger (IT)	
Brick dimensions [mm]	250 x 120 x 250	
Drilling method	Rotary	

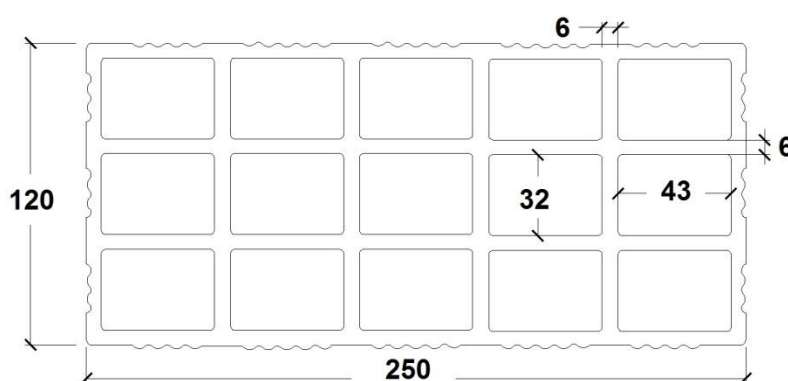
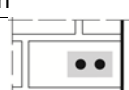
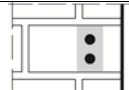

Table C89: Installation parameters

Anchor size		[-]	All sizes
Edge distance	C_{cr}	[mm]	100 (120) ¹⁾
Minimum edge distance	C_{min}	[mm]	60
Spacing	$S_{cr, }$	[mm]	250
	$S_{cr,\perp}$	[mm]	120
Minimum spacing	S_{min}	[mm]	100

¹⁾ Value in brackets for sleeves 20x85; 20x130 and 20x200

Table C90: Group factor for anchor group in case of tension loading

Configuration		with $c \geq$	with $s \geq$			
: anchors placed parallel to horizontal joint		60	100	$\alpha_{g,N, }$	[-]	1,0
		C_{cr}	250			2,0
⊥: anchors placed perpendicular to horizontal joint		60	100	$\alpha_{g,N,\perp}$		2,0

Injection System VT-HP® for masonry

Performances clay hollow brick Blocchi Leggeri

Description of the brick
Installation parameters

Annex C36

Brick type: Clay hollow brick Blocchi Leggeri**Table C91: Group factor for anchor group in case of shear loading parallel to free edge**

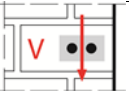
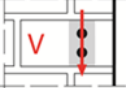
Configuration		with $c \geq$	with $s \geq$			
II: anchors placed parallel to horizontal joint		60 ¹⁾	100 ¹⁾	$\alpha_{g,V,II}$	[-]	1,0
		c_{cr}	250			2,0
⊥: anchors placed perpendicular to horizontal joint		60 ¹⁾	100 ¹⁾	$\alpha_{g,V,\perp}$		1,6
		c_{cr}	250			2,0

¹⁾ Only valid for $V_{Rk,b}$ according to Table C93 and C94 values in brackets

Table C92: Group factor for anchor group in case of shear loading perpendicular to free edge

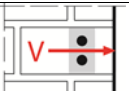
Configuration		with $c \geq$	with $s \geq$			
II: anchors placed parallel to horizontal joint		60 ¹⁾	100 ¹⁾	$\alpha_{g,V,II}$	[-]	1,0
		c_{cr}	250			2,0
⊥: anchors placed perpendicular to horizontal joint		60 ¹⁾	100 ¹⁾	$\alpha_{g,V,\perp}$		1,6
		c_{cr}	250			2,0

¹⁾ Only valid for $V_{Rk,b}$ according to Table C93 and C94 values in brackets

Table C93: Characteristic values of resistance under tension and shear loads

Anchor size	Sleeve	Effective anchorage depth	Characteristic resistance			
			Use category			
			d/d; w/d; w/w			
			40°C/24°C	80°C/50°C	120°C/72°C	For all temperature range
		h_{ef}	$N_{Rk,b} = N_{Rk,p}^{1)}$			$V_{Rk,b}^{4)}$
		[mm]	[kN]			
Compressive strength $f_b \geq 4 \text{ N/mm}^2$						
M8	12x80	80	0,4	0,4	0,3	2,0 ²⁾ (0,9) ³⁾
M8 / M10	16x85	85				
	16x130	130				
M12 / M16	20x85	85				
	20x130	130				
	20x200	200				
Compressive strength $f_b \geq 6 \text{ N/mm}^2$						
M8	12x80	80	0,5	0,5	0,4	2,5 ²⁾ (1,2) ³⁾
M8 / M10	16x85	85				
	16x130	130				
M12 / M16	20x85	85				
	20x130	130				
	20x200	200				

1) Values are valid for c_{cr} and c_{min}

2) Calculation of $V_{Rk,c}$ see ETAG 029, Annex C, except for shear load parallel to free edge with $c \geq 125 \text{ mm}$: $V_{Rk,c,II} = V_{Rk,b}$

3) Values in brackets $V_{Rk,c} = V_{Rk,b}$ for anchors with c_{min}

4) The values are valid for steel 5.6 or greater. For steel 4.6 and 4.8 multiply $V_{Rk,b}$ by 0,8

Injection System VT-HP® for masonry

Performances clay hollow brick Blocchi Leggeri

Installation parameters (continue)

Characteristic values of resistance under tension and shear load

Annex C37

Brick type: Clay hollow brick Blocchi Leggeri**Table C94: Characteristic values of resistance under tension and shear loads (continue)**

Anchor size	Sleeve	Effective anchorage depth	Characteristic resistance			
			Use category			
			d/d w/d w/w			
			40°C/24°C	80°C/50°C	120°C/72°C	For all temperature range
h_{ef}	$N_{Rk,b} = N_{Rk,p}^{1)}$			$V_{Rk,b}^{4)}$		
[mm]	[kN]					
Compressive strength $f_b \geq 8 \text{ N/mm}^2$						
M8	12x80	80	0,6	0,6	0,5	3,0 ²⁾ (1,2) ³⁾
M8 / M10	16x85	85				
	16x130	130				
M12 / M16	20x85	85				
	20x130	130				
	20x200	200				
Compressive strength $f_b \geq 12 \text{ N/mm}^2$						
M8	12x80	80	0,6	0,6	0,6	3,5 ²⁾ (1,5) ³⁾
M8 / M10	16x85	85				
	16x130	130				
M12 / M16	20x85	85				
	20x130	130				
	20x200	200				

1) Values are valid for c_{cr} and c_{min} 2) Calculation of $V_{Rk,c}$ see ETAG 029, Annex C, except for shear load parallel to free edge with $c \geq 125 \text{ mm}$: $V_{Rk,c,II} = V_{Rk,b}$ 3) Values in brackets $V_{Rk,c} = V_{Rk,b}$ for anchors with c_{min} 4) The values are valid for steel 5.6 or greater. For steel 4.6 and 4.8 multiply $V_{Rk,b}$ by 0,8**Table C95: Displacements**

Anchor size	Sleeve	Effective anchorage depth h_{ef}	N	δ_N / N	δ_{N0}	$\delta_{N\infty}$	V	δ_{V0}	$\delta_{V\infty}$
			[kN]	[mm/kN]	[mm]	[mm]	[kN]	[mm]	[mm]
All sizes	All sizes	All sizes	0,17	1,20	0,21	0,41	0,9	1,20	1,80

Injection System VT-HP® for masonry**Annex C38****Performances clay hollow brick Blocchi Leggeri**

Characteristic values of resistance under tension and shear load (continue)

Displacements

Brick type: Clay hollow brick Doppio Uni

Table C96: Description of the brick

Brick type	Clay hollow brick Doppio Uni
Bulk density ρ [kg/dm ³]	0,9
Compressive strength $f_b \geq$ [N/mm ²]	10, 16, 20 or 28
Code	EN 771-1
Producer (country code)	e.g. Wienerberger (IT)
Brick dimensions [mm]	250 x 120 x 120
Drilling method	Rotary

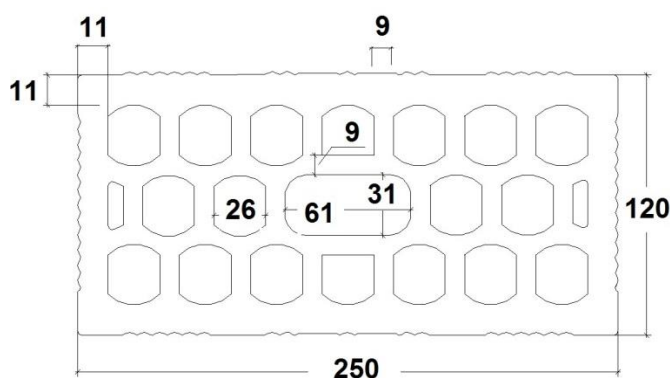
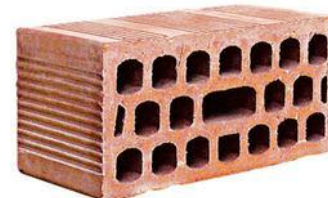

Table C97: Installation parameters

Anchor size		[-]	All sizes
Edge distance	C_{cr}	[mm]	100 (120) ¹⁾
Minimum edge distance	$C_{min}^{2)}$	[mm]	60
Spacing	$S_{cr,II}$	[mm]	250
	$S_{cr,\perp}$	[mm]	120
Minimum spacing	$S_{min,II}$	[mm]	100
	$S_{min,\perp}$	[mm]	120

1) Value in brackets for sleeves 20x85; 20x130 and 20x200

2) For $V_{Rk,c}$: C_{min} according to ETAG 029, Annex C

Table C98: Group factor for anchor group in case of tension loading

Configuration		with $c \geq$	with $s \geq$			
II: anchors placed parallel to horizontal joint		60	100	$\alpha_{g,N,II}$	[-]	1,0
		C_{cr}	250			2,0
I: anchors placed perpendicular to horizontal joint		60	120	$\alpha_{g,N,I}$		2,0

Injection System VT-HP® for masonry

Performances clay hollow brick Doppio Uni

Description of the brick
Installation parameters

Annex C39

Brick type: Clay hollow brick Doppio Uni**Table C99: Group factor for anchor group in case of shear loading parallel to free edge**



Configuration		with $c \geq$	with $s \geq$			
: anchors placed parallel to horizontal joint		C_{cr}	250	$\alpha_{g,V, }$	[-]	2,0
⊥: anchors placed perpendicular to horizontal joint		C_{cr}	120	$\alpha_{g,V,\perp}$		2,0

Table C100: Group factor for anchor group in case of shear loading perpendicular to free edge

Configuration		with $c \geq$	with $s \geq$			
: anchors placed parallel to horizontal joint		C_{cr}	250	$\alpha_{g,V, }$	[-]	2,0
⊥: anchors placed perpendicular to horizontal joint		C_{cr}	120	$\alpha_{g,V,\perp}$		2,0

Table C101: Characteristic values of resistance under tension and shear loads

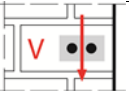
Anchor size	Sleeve	Effective anchorage depth	Characteristic resistance			
			Use category			
			d/d w/d w/w			
			40°C/24°C	80°C/50°C	120°C/72°C	For All temperature range
		h_{ef}	$N_{Rk,b} = N_{Rk,p}^{1)}$			$V_{Rk,b}^{2)3)}$
		[mm]	[kN]			
Compressive strength $f_b \geq 10 \text{ N/mm}^2$						
M8	12x80	80	0,6	0,6	0,5	1,5
M8 / M10	16x85	85				
	16x130	130				
M12 / M16	20x85	85				
	20x130	130				
	20x200	200				
Compressive strength $f_b \geq 16 \text{ N/mm}^2$						
M8	12x80	80	0,75	0,75	0,6	2,0
M8 / M10	16x85	85				
	16x130	130				
M12 / M16	20x85	85				
	20x130	130				
	20x200	200				

1) Values are valid for c_{cr} and c_{min} 2) Calculation of $V_{Rk,c}$ see ETAG 029, Annex C3) The values are valid for steel 5.6 or greater. For steel 4.6 and 4.8 multiply $V_{Rk,b}$ by 0,8**Injection System VT-HP® for masonry****Performances clay hollow brick Doppio Uni**

Installation parameters (continue)

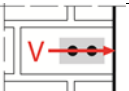
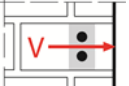
Characteristic values of resistance under tension and shear load

Annex C40

Brick type: Clay hollow brick Doppio Uni**Table C102: Characteristic values of resistance under tension and shear loads (continue)**

Anchor size	Sleeve	Effective anchorage depth	Characteristic resistance			
			Use category			
			d/d w/d w/w			
			40°C/24°C	80°C/50°C	120°C/72°C	For All temperature range
h_{ef}	$N_{Rk,b} = N_{Rk,p}^{1)}$			$V_{Rk,b}^{2)3)}$		
		[mm]	[kN]			
Compressive strength $f_b \geq 20 \text{ N/mm}^2$						
M8	12x80	80	0,9	0,9	0,75	2,0
M8 / M10	16x85	85				
	16x130	130				
M12 / M16	20x85	85				
	20x130	130				
	20x200	200				
Compressive strength $f_b \geq 28 \text{ N/mm}^2$						
M8	12x80	80	1,2	1,2	0,9	2,5
M8 / M10	16x85	85				
	16x130	130				
M12 / M16	20x85	85				
	20x130	130				
	20x200	200				

1) Values are valid for c_{cr} and c_{min} 2) Calculation of $V_{Rk,c}$ see ETAG 029, Annex C3) The values are valid for steel 5.6 or greater. For steel 4.6 and 4.8 multiply $V_{Rk,b}$ by 0,8**Table C103: Displacements**

Anchor size	Sleeve	Effective anchorage depth h_{ef}	N	δ_N / N	δ_{N0}	$\delta_{N\infty}$	V	δ_{V0}	$\delta_{V\infty}$
		[mm]	[kN]	[mm/kN]	[mm]	[mm]	[kN]	[mm]	[mm]
All sizes	All sizes	All sizes	0,26	1,20	0,31	0,62	0,6	0,3	0,45

Injection System VT-HP® for masonry**Performances clay hollow brick Doppio Uni**

Characteristic values of resistance under tension and shear load (continue)

Displacements

Annex C41

Brick type: Hollow Light weight concrete Bloc creux B40

Table C104: Description of the brick

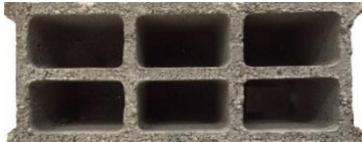
Brick type	Hollow light weight concrete Bloc creux B40	
Bulk density ρ [kg/dm ³]	0,8	
Compressive strength $f_b \geq$ [N/mm ²]	4	
Code	EN 771-3	
Producer (country code)	e.g. Sepa (FR)	
Brick dimensions [mm]	494 x 200 x 190	
Drilling method	Rotary	

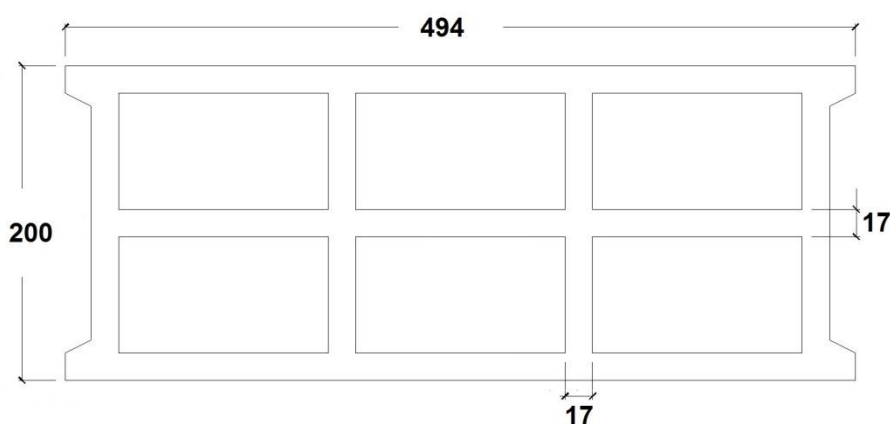

Table C105: Installation parameters

Anchor size		[-]	All sizes
Edge distance	C_{cr}	[mm]	100 (120) ¹⁾
Minimum edge distance	$C_{min}^{2)}$	[mm]	100 (120) ¹⁾
Spacing	$S_{cr,II}$	[mm]	494
	$S_{cr,\perp}$	[mm]	190
Minimum spacing	S_{min}	[mm]	100

¹⁾ Value in brackets for sleeves 20x85 and 20x130

²⁾ For $V_{Rk,c}$: C_{min} according to ETAG 029, Annex C

Table C106: Group factor for anchor group in case of tension loading

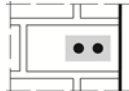
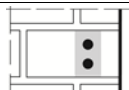
Configuration		with $c \geq$	with $s \geq$			
II: anchors placed parallel to horizontal joint		100	100	$\alpha_{g,N,II}$	[-]	1,5
		C_{cr}	494			2,0
\perp : anchors placed perpendicular to horizontal joint		100	100	$\alpha_{g,N,\perp}$	[-]	1,0
		C_{cr}	190			2,0

Injection System VT-HP® for masonry

Performances hollow light weight concrete Bloc creux B40

Description of the brick
Installation parameters

Annex C42

Brick type: Hollow Light weight concrete Bloc creux B40**Table C107: Group factor for anchor group in case of shear loading parallel to free edge**

Configuration		with $c \geq$	with $s \geq$			
II: anchors placed parallel to horizontal joint		50	100	$\alpha_{g,V,II}$	[-]	1,1
		c_{cr}	494			2,0
⊥: anchors placed perpendicular to horizontal joint		100	100	$\alpha_{g,V,\perp}$		1,1
		c_{cr}	190			2,0

Table C108: Group factor for anchor group in case of shear loading perpendicular to free edge

Configuration		with $c \geq$	with $s \geq$			
II: anchors placed parallel to horizontal joint		c_{cr}	494	$\alpha_{g,V,II}$	[-]	2,0
		⊥: anchors placed perpendicular to horizontal joint				c_{cr}

Table C109: Characteristic values of resistance under tension and shear loads

Anchor size	Sleeve	Effective anchorage depth	Characteristic resistance						
			Use category						
			d/d			w/d			d/d
			40°C/24°C	80°C/50°C	120°C/72°C	40°C/24°C	80°C/50°C	120°C/72°C	w/d
			$N_{Rk,b} = N_{Rk,p}^{1)}$			$N_{Rk,b} = N_{Rk,p}^{1)}$			For all temperature range
		h_{ef}	$[kN]$						
		[mm]							
Compressive strength $f_b \geq 4 \text{ N/mm}^2$									
M8	12x80	80	1,2	0,9	0,75	0,9	0,9	0,75	3,0
M8 / M10	16x85	85	1,2	0,9	0,75	1,2	0,9	0,75	3,0
	16x130	130	1,2	0,9	0,75	1,2	0,9	0,75	3,0
M12 / M16	20x85	85	1,2	0,9	0,75	1,2	0,9	0,75	3,0
	20x130	130	1,2	0,9	0,75	1,2	0,9	0,75	3,0

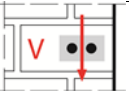
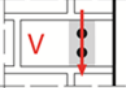
1) Values are valid for c_{cr} and c_{min} 2) Calculation of $V_{Rk,c}$ see ETAG 029, Annex C, except for shear load parallel to free edge with $c \geq 250 \text{ mm}$: $V_{Rk,c,II} = V_{Rk,b}$ 3) The values are valid for steel 5.6 or greater. For steel 4.6 and 4.8 multiply $V_{Rk,b}$ by 0,8**Table C110: Displacements**

Anchor size	Sleeve	Effective anchorage depth h_{ef}	N	δ_N / N	δ_{N0}	$\delta_{N\infty}$	V	δ_{V0}	$\delta_{V\infty}$
			[kN]	[mm/kN]	[mm]	[mm]	[kN]	[mm]	[mm]
All sizes	All sizes	All sizes	0,34	0,90	0,31	0,62	0,86	0,9	1,35

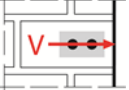
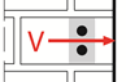
Injection System VT-HP® for masonry**Performances hollow light weight concrete brick Bloc creux B40**

Installation parameters (continue)

Characteristic values of resistance under tension and shear load / Displacements

Annex C43

Brick type: Solid light weight concrete brick - LAC**Table C111: Description of the brick**

Brick type	Solid light weight concrete brick		
Bulk density ρ [kg/dm ³]	0,6		
Compressive strength $f_b \geq$ [N/mm ²]	2		
Code	EN 771-3		
Producer (country code)	e.g. Bisotherm (DE)		
Brick dimensions [mm]	300 x 123 x 248		
Drilling method	Rotary		

Table C112: Installation parameter

Anchor size		[-]	All sizes
Edge distance	c_{cr}	[mm]	$1,5 \cdot h_{ef}$
Minimum edge distance	c_{min}	[mm]	60
Spacing	s_{cr}	[mm]	$3 \cdot h_{ef}$
Minimum spacing	s_{min}	[mm]	120

Table C113: Group factor for anchor group in case of tension loading

Configuration		with $c \geq$	with $s \geq$			
II: anchors placed parallel to horizontal joint		90	120	$\alpha_{g,N,II}$	[-]	1,1
		$1,5 \cdot h_{ef}$	$3 \cdot h_{ef}$			2,0
⊥: anchors placed perpendicular to horizontal joint		124	120	$\alpha_{g,N,\perp}$		1,1
		$1,5 \cdot h_{ef}$	$3 \cdot h_{ef}$			2,0

Table C114: Group factor for anchor group in case of shear loading parallel to free edge

Configuration		with $c \geq$	with $s \geq$			
II: anchors placed parallel to horizontal joint		60	120	$\alpha_{g,V,II}$	[-]	0,6
		90	120			2,0
⊥: anchors placed perpendicular to horizontal joint		60	120	$\alpha_{g,V,\perp}$		0,6
		124	120			2,0

Table C115: Group factor for anchor group in case of shear loading perpendicular to free edge

Configuration		with $c \geq$	with $s \geq$			
II: anchors placed parallel to horizontal joint		60	120	$\alpha_{g,V,II}$	[-]	0,6
		90	120			2,0
⊥: anchors placed perpendicular to horizontal joint		60	120	$\alpha_{g,V,\perp}$		0,6
		$1,5 \cdot h_{ef}$	120			1,0
		$1,5 \cdot h_{ef}$	$3 \cdot h_{ef}$		2,0	

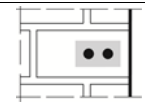
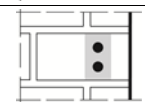
Injection System VT-HP® for masonry**Annex C44****Performances solid light weight concrete brick - LAC**

Description of the brick

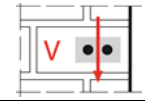
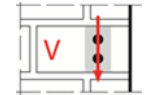
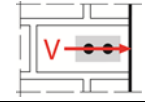
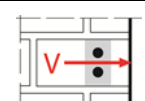
Installation parameters

Brick type: Solid light weight concrete brick - LAC**Table C116: Characteristic values of resistance under tension and shear loads**

Anchor size	Sleeve	Effective anchorage depth	Characteristic resistance						
			Use category						
			d/d			w/d w/w			d/d w/d w/w
			40°C/24°C	80°C/50°C	120°C/72°C	40°C/24°C	80°C/50°C	120°C/72°C	For all temperature range
h_{ef}	$N_{Rk,b} = N_{Rk,p}^{1)}$			$N_{Rk,b} = N_{Rk,p}^{1)}$			$V_{Rk,b}^{2)3)}$		
[mm]	[kN]								
Compressive strength $f_b \geq 2 \text{ N/mm}^2$									
M8	-	80	3,0	2,5	2,0	2,5	2,0	1,5	3,0
M8 / M10	-	90	3,0	3,0	2,0	2,5	2,5	2,0	3,0
M12	-	100	3,5	3,0	2,5	3,0	2,5	2,0	3,0
M16	-	100	3,0	3,0	2,0	3,0	3,0	2,0	3,0
M8	12x80	80	2,5	2,5	2,0	2,5	2,0	1,5	3,0
M8 / M10	16x85	85	3,0	2,5	2,0	3,0	2,5	2,0	3,0
	16x130	130	3,0	2,5	2,0	3,0	2,5	2,0	3,0
M12 / M16	20x85	85	2,5	2,5	2,0	2,5	2,5	2,0	3,0
	20x130	130	2,5	2,5	2,0	2,5	2,5	2,0	3,0
	20x200	200	2,5	2,5	2,0	2,5	2,5	2,0	3,0

1) Values are valid for C_{cr} , values in brackets are valid for single anchors with C_{min}

2) For calculation of $V_{Rk,c}$ see ETAG029, Annex C

3) The values are valid for steel 5.6 or greater. For steel 4.6 and 4.8 multiply $V_{Rk,b}$ by 0,8

Table C117: Displacements

Anchor size	Sleeve	Effective anchorage depth h_{ef}	N	δ_N / N	δ_{N0}	$\delta_{N\infty}$	V	δ_{v0}	$\delta_{v\infty}$
			[mm]	[kN]	[mm/kN]	[mm]	[mm]	[kN]	[mm]
M8	-	80	0,86	0,50	0,43	0,86	0,9	0,25	0,38
M8 / M10	-	90							
M12	-	100	0,35	0,35	0,70				
M16	-	100				0,30			
M8	12x80	80	0,71	0,50	0,36	0,71			
M8 / M10	16x85	85							
	16x130	130							
M12 / M16	20x85	85					0,35	0,25	0,50
	20x130	130							
	20x200	200							

Injection System VT-HP® for masonry**Annex C45****Performances solid light weight concrete brick - LAC**

Characteristic values of resistance under tension and shear load

Displacements