

ETERPAN[®] CTU

Installation Guide

**Strong
and stable
substrate
for tiling**

**High Performance
Fibre Cement Board**



Table of Contents

ETERPAN® CTU	3
ETERPAN® CTU Technical Specifications	4
General Properties	4
Working With ETERPAN® CTU	5
Loading And Unloading	5
Transport To Site	5
Storage	5
Handling Of ETERPAN® CTU Fibre Cement Boards	6
Cutting ETERPAN® CTU Fibre Cement Boards	6
Drilling ETERPAN® CTU Fibre Cement Boards	6
Design Specifications	7
Compliance	7
Fixing ETERPAN® CTU Fibre Cement Boards	7
Floor Installation	8
Preparation	8
Sheet Layout	8
Sheet Fixing	8
Control Joints	9
Finishing	10
Health & Safety	11

ETERPAN[®] CTU





ETERPAN[®] CTU fibre cement board is a great Ceramic Tile backer board for dry construction applications. Immune to long-term moisture exposure, ETERPAN[®] CTU Fibre Cement Boards do not feed or promote mould growth in humid areas. Its delamination strength, can be up to 70% higher than a water resistant plasterboard.

ETERPAN[®] CTU fibre cement board, offers a very low moisture movement, which makes it a very stable and robust substrate for ceramic and stone tiling; the board will not bow or deform during service.

The following application guide, provides the basic recommendations for tiling trades in interior applications. For more information or specific needs, please contact our Technical Department.

A versatile fibre cement board



-  Resistant to the attack of termites, insects and most other vermin
-  Moist, mould and water resistant
-  Top quality raw materials from sustainable resources
-  Impact resistant
-  Dimensionally stable

ETERPAN[®] CTU has been designed for dry construction solutions with outstanding impact resistance and long term durability with no degradation of the physical and mechanical properties.

ETERPAN[®] CTU also has a precise combination of density and strength to make it suitable in applications where workability in installation and fire performance is paramount.



Impact resistance



Fire resistance



Water resistance

Technical Specifications

Dimensions

Length (mm)	Width (mm)	Thickness (mm)
1800	900	6

General Technical Properties

Dimensional Conformity (tested to AS/NZS 2908.2)		Pass
Length	mm	± 8
Width	mm	± 5
Thickness		± 10%
Straightness of edges	mm/m	3
Squareness of edges	mm/m	4
Density (tested to AS/NZS 2908.2)	kg/m ³	≥1250
Modulus of rupture (tested to AS/NZS 2908.2) (Type B . Category 3)	MPa	≥10
Water permeability (tested to AS/NZS 2908.2)		Pass
Moisture content (tested to ASTM C1185)		≤15%
Water absorption (tested to ASTM C1185)		≤33%
Moisture movement (tested to ASTM C1185)		≤0.04%
Thermal conductivity (tested to ASTM C518-76)	W/m ² K	0.27

Durability

Warm water performance (tested to AS/NZS 2908.2)	Pass
Soak-dry performance (tested to AS/NZS 2908.2)	Pass

Reaction To Fire

Combustibility (BS 476 Part 4)	Non-Combustible
Surface spread of flame (tested to BS 476 Part 7)	Class 1
Fire propagation index (tested to BS 476 Part 6)	I = 1.6
Heat and Smoke Release (tested to ISO 5660.1)	Group 1 S
Fire Hazard Properties (tested to AS/NZS 1530.3)	
Ignitability Index	0
Spread of Flame Index	0
Heat Evolved Index	0
Smoke Developed Index	0-1

Working with ETERPAN® CTU

Loading And Unloading

ETERPAN® CTU fibre cement boards are usually supplied on pallets suitable for forklift. If crane offloading by slings is envisaged, special notification must be made in advance or upon placing orders.

All pallets and crates can be safely handled by using a barge lift or hoisting equipment and straps. Steel cables should not be used as it will damage both the pallet and the panels within.

When the crates have to be removed from a box container, care must be taken NOT to expose crates or pallets to the shock of any impact, as the shock could result in cracks in the boards.

Transport To Site

Always drive the delivery vehicle as close as possible to the location where the panels are to be installed. When transporting the panels, it is essential to firmly secure the pallets to prevent the panels from sliding or moving while in transit.

Storage

ETERPAN® CTU fibre cement boards are supplied with protective plastic sheeting wrapped around the timber crates. This protection should not be removed until site and structural conditions are prepared and ready for panel installation.

All ETERPAN® CTU fibre cement boards must be stored flat on pallets and placed inside in covered and dry conditions, optimising protection for stored panels against exposure to weather and other unfavourable conditions.

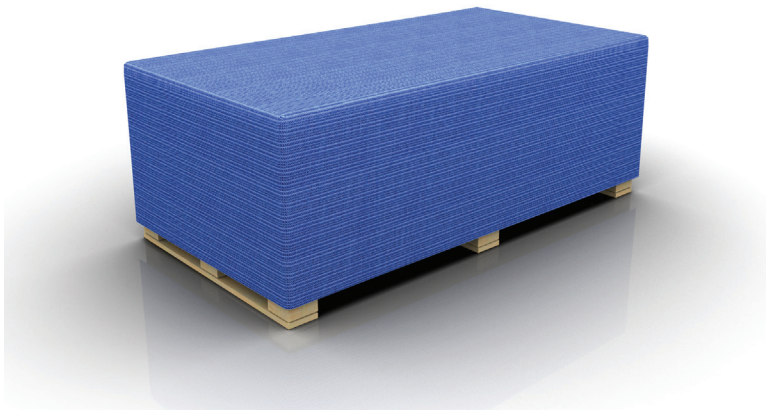

Figure 1

Protective Plastic Sheetting

Handling Of ETERPAN[®] CTU Fibre Cement Boards

The following must be taken into consideration when handling ETERPAN[®] CTU fibre cement boards.



Figure 2

Whenever possible, lift the panel from the stack below rather than slide panel or drag off the stack. This will prevent damage to the lower panel.

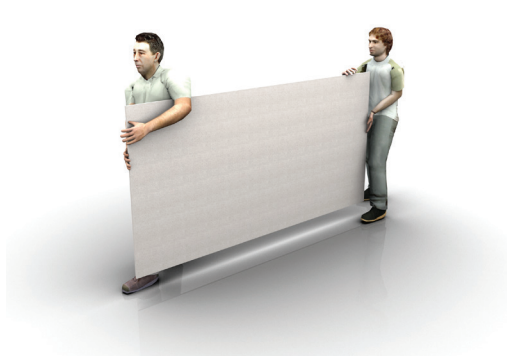

Figure 3

Always carry the panel on edge but DO NOT store on edge

Cutting ETERPAN[®] CTU Fibre Cement Boards

ETERPAN[®] CTU fibre cement boards offer easy workability with conventional tools, on or off construction sites. The method of cutting is dependent on the amount of cutting. Cutting of the panel can be achieved using stationary table saws, circular saw, and jigsaws. Cutting must take place in a dry environment. Dust control is required.

It is recommended that fibre cement saw blades (see figure 4) are used to cut the panels on site. These blades have been designed especially for fibre cement and when correctly employed, a high level of finish can be achieved. The blade is uniquely designed with vibration damping composite body construction and diamond tipped teeth shaped to give a tear-free edge.

When small amounts of cutting are required on site, an alternative to the recommended fibre cement saw blade is a carbide-tipped flat trapezoidal tooth blade. This has limited life and will need regular changing.



Figure 4

Fibre cement blade.

Drilling ETERPAN[®] CTU Fibre Cement Boards

ETERPAN[®] CTU fibre cement boards should be drilled using preferred and more efficient tungsten carbide tipped drills with point angles of 60° to 80° rather than the usual 120° type.

Design Specifications

Compliance

Designers and/or contractors responsible for the intended project should follow the details and recommendations specified in this manual.

It is also wise to keep in mind that all designs and constructions should comply with appropriate and relevant requirements of current legal building codes, regulations and standards, both domestic and international.

The information provided in this installation guidelines is valid at the time of publication. Please consult ETERPAN or its nearest official representative for further versions or updates.

Fixing ETERPAN® CTU Fibre Cement Boards

Consideration of fasteners durability will be influenced by material choice, environmental factors and compatibility of materials in contact with fasteners. In general, the fasteners of choice should be resistant to corrosion.

ETERPAN® CTU fibre cement boards can fixed with jolt head galvanised or stainless steel nails.

Fixing Requirements

55 x 2.8mm flat head and jolt head galvanized or stainless steel

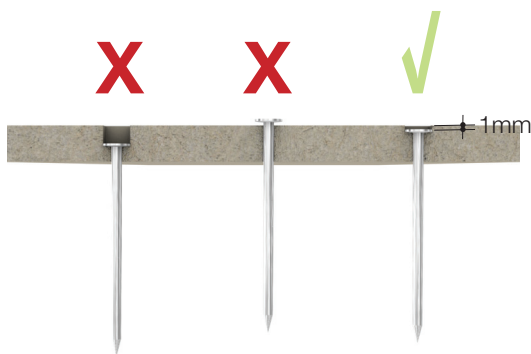

Figure 5

Position of fasteners

Floor Installation

Preparation

The installer must check that the subfloor is structurally sound and in good condition. All unevenness, deformations, warping or loose pieces, must be properly fixed and removed before ETERPAN[®] CTU is laid over the substrate. If ETERPAN[®] CTU is not totally supported by the subfloor, it will crack and affect the quality of rigid finishes installed on top of it (stone, ceramic tiles, etc.).

Subfloors must comply with the local building codes and standards. Maximum allowable deflections for rigid finishes cannot be greater than $L/360$.

Remove existing floor coverings, check the floor is clean of dust, grease and any dirt and reasonably flat and well nailed down.

Ensure the floor and supporting framework is adequate to support the tiling, is firmly fixed and the underside is well ventilated and free from damp.

If the floor is warped it may need sanding flat.

Sheet Layout

ETERPAN[®] CTU must be installed in a staggered pattern. Position the sheet length across the direction of the floor underlay. The sheet edge must not coincide with the underlay floor joint.

Allow a gap of at least 5mm between the edge of the ETERPAN[®] CTU and the perimeter / vertical walls. This gap can be covered by the skirt, but the lower edge of the skirting cannot be adhered to the surface of ETERPAN[®] CTU and the finish. This gap is needed to absorb the natural moisture and thermal movement in the system.

Sheet Fixing

ETERPAN[®] CTU can be nailed or screwed onto the subfloor layer. Maximum distance between fixing elements cannot be greater than 150mm. Corners must be fixed following the pattern shown on Figure 6.

A nailing pattern is marked on the boards for installation assistance. However, additional fixings are required around the perimeter as per Figure 7.

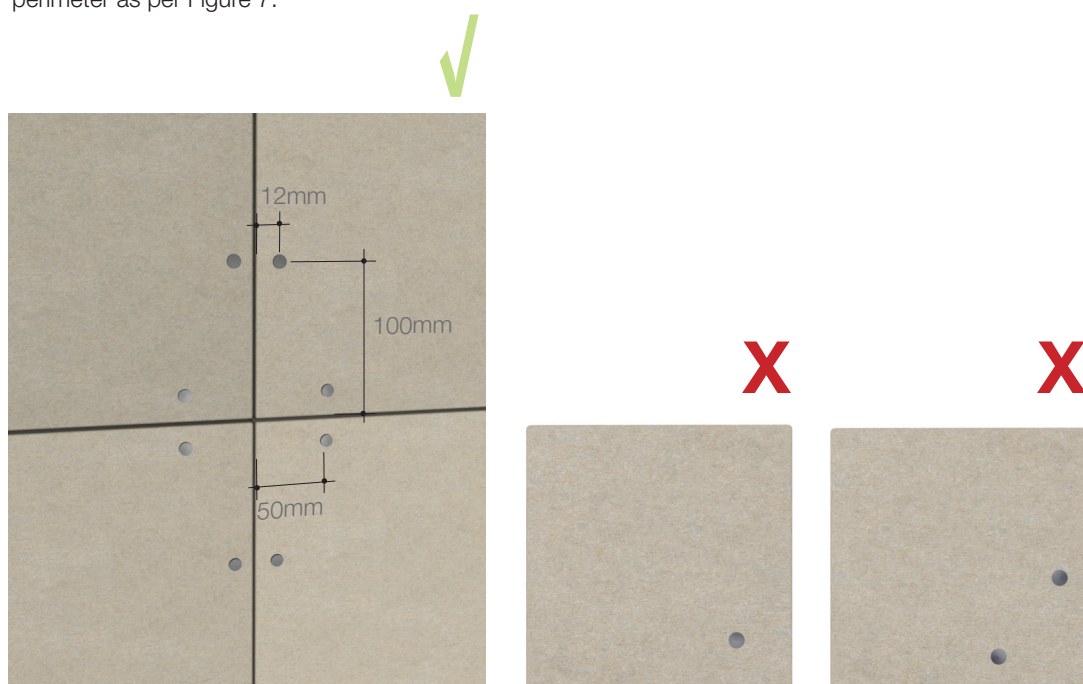

Figure 6

Correct fastener's position

Screw or nail the board as per Figure 7. Lay tiles and adhesives in accordance with the manufacturer's recommendations.

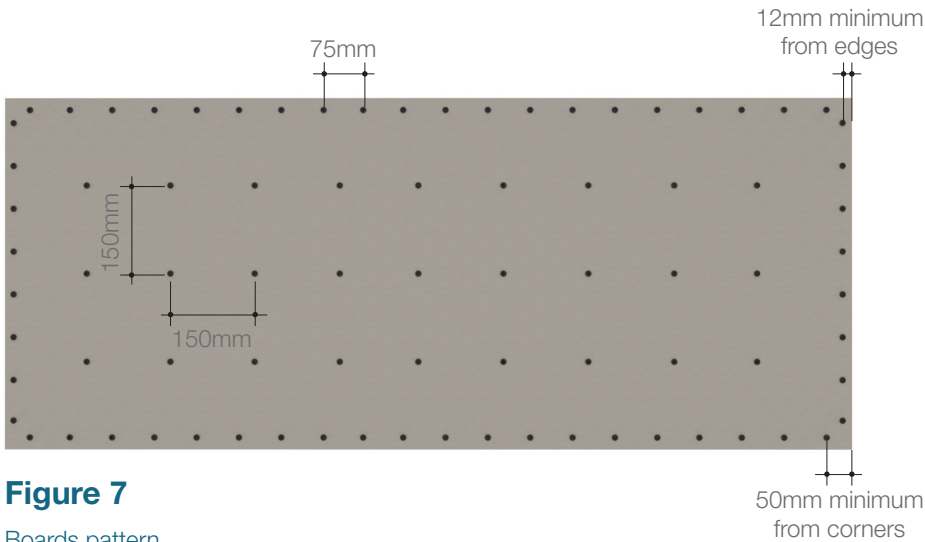

Figure 7
Boards pattern

Control Joints

Movement stress from dimensional changes due to varying temperature or moisture conditions can cause cracking and other symptoms of stress. Control joints are required where existing movement joints are located if a floor is longer than 5000mm. Please note that control joints must not be covered by any rigid floor covering such as tiles. The control joint between the boards must be greater than 5mm and less than 10mm. Place a backing rod into the joint and compress firmly until it is resting on the timber or steel joist. Apply a flexible sealant to the remainder of the joint.

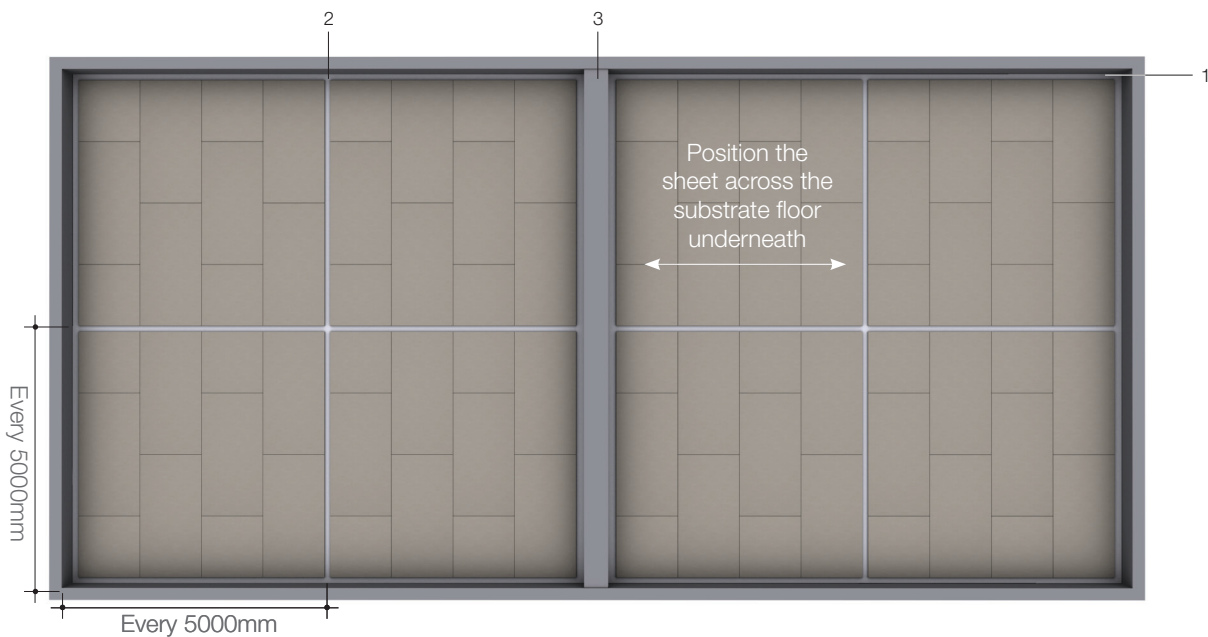

Figure 9
Movement and perimeter joints

1. Perimetral dilatation (5mm from walls and perimetral boundaries)
2. Movement joints
3. Walls and perimetral boundaries

ETERPAN® CTU

Finishing

ETERPAN® CTU can be covered with ceramic tiles or stone veneers. Polymer modified tiles adhesive tiles can be used. The installer must observe the recommendations given by the manufacturer at all times. Some adhesives might require adhesive primers before their application.



Figure 8

Installation of ETERPAN® CTU

1. Joists
2. Floor substrate
3. ETERPAN® CTU 6mm
4. Tiles adhesive
5. Tiles / Finish

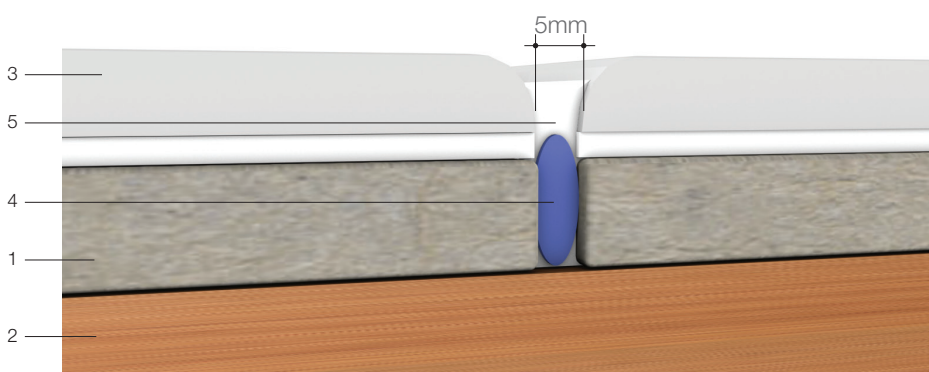

Figure 10

Movement joints

1. ETERPAN® CTU 6mm
2. Floor substrate
3. Tiles / Finishing
4. Backer rod
5. Sealant

Health & Safety

As for all products containing quartz (e.g. concrete and clay), ETERPAN® CTU when machined mechanically (cutting, sanding, drilling) will release dust which may contain quartz particles. Inhalation of high concentrations of dust may irritate the airways. Dust may also cause irritation of the eyes and/or skin. Inhalation of dust containing quartz, in particular the fine (respirable size) dust particulate matter, in high concentrations or over prolonged periods of time, can lead to lung disease (silicosis) and an increased risk of lung cancer.

Avoid dust inhalation by using cutting equipment which features dust extraction or suppression accessories where practicable.

Ensure adequate ventilation in the work place.

Avoid contact with the eyes and skin and inhalation of dust by wearing appropriate personal protective equipment (safety goggles, protective clothing) and approved respirator, a dust mask of at least type P2.

For more information, consult the appropriate Product Data Sheet, available upon request.

ETERPAN[®] CTU



Dry construction solutions are efficient and long lasting when the right practices of installation are followed. Please contact us for technical support. Our Service Center will give you the best recommendations

New Zealand Distributor:

Fibre Cement Solutions Ltd

www.fibrementsolutions.co.nz

PO Box 331219, Takapuna, Auckland 0740, New Zealand