

C E M I N T E L[®]
T E R R I T O R Y[™]

NEW ZEALAND DESIGN AND INSTALLATION GUIDE



INTRODUCTION

TABLE OF CONTENTS

01 INTRODUCTION	1	06 SYSTEM ENGINEERING	19
Introduction	1	Design, Detailing and Performance	
02 PRODUCT OVERVIEW	2	Responsibilities	20
Panel Information	3	Span Tables / Wind Loads	21
Colour Palette	4	Masonry Substrates	23
03 SYSTEM OVERVIEW	5	07 INSTALLATION	24
Applications	7	Prior to Installation	25
Benefits of the Cemintel Territory System	7	Installation Set-Out	26
Product Specifications/System Solutions	7	Installation for Timber and Steel Framing	27
04 DESIGN + AESTHETIC CONSIDERATIONS	8	Step-by-step Installation	35
General	9	Installation for Masonry	37
Control Joints	10	08 CONSTRUCTION DRAWINGS + DETAILS	38
Structural	11	09 SAFETY, HANDLING + GENERAL CARE	59
Weatherproofing	12	Health, Safety and PPE	59
Wall Wrap/Sarking Moisture Management	12	Handling & General Care	59
Insulation and Energy Efficiency	13	10 WARRANTY, CLEANING + MAINTENANCE	60
Extreme Climate Conditions	13	Warranty	60
Other Design Considerations	14	Wash Down Process	60
05 COMPONENTS + ACCESSORIES	15	Inspection, Repair and Maintenance	60

Introduction

Cemintel's Territory cavity walling system combines a prefinished panel with a simple installation system that can be used externally or internally for residential and commercial buildings.

This Design and Installation Guide recommends good building practice methodology and has been prepared as a general guide of design considerations, system engineering information and installation procedures for common external vertical installations. It assumes that the user has an intermediate knowledge level of building design and construction. In no way does it replace the services of the building professionals required to design projects, nor is it an exhaustive guide of all possible scenarios. It is the

responsibility of the architect, designer and various engineering parties to ensure that the details in this Design and Installation Guide are appropriate for the intended application.

Territory can be installed either vertically or horizontally, externally or internally. This guide refers to **external vertical installations** only as components differ depending on the installation.

Refer to the 'Design and Installation Guide for Cemintel® Territory External Horizontal Installation' or the 'Design and Installation Guide for Cemintel Territory Internal Installation' for instructions regarding these applications.

A large, stylized graphic of the number '022' in a light gray, outlined font, positioned in the lower half of the page. The '0' is a simple oval, the first '2' has a curved top, and the second '2' is more angular.

PRODUCT OVERVIEW

Panel Information

Cemintel Territory panels are cement bonded fibrous wood particle products that are pressed with a surface texture. They are cut to a standard length of 3030mm with an effective cover width of 455mm and 16mm nominal thickness. The horizontal edges of the panel are machined with a complementary tongue and groove profile. A compressible sealing strip is bonded onto the tongue which enables the panels to fit neatly together to form a weather resistant joint.

The panels have been pre-finished using a durable multi-layered paint process to simulate a range of textured finishes, for example, timber, concrete, stone or render. They are ready-to-install and are highly durable.

Panels have a special NichiGuard® self cleaning coating* applied during the manufacturing process to Japanese standards. Panels include Platinum Coating technology to protect against UV damage and colour fade.

There is a range of colour matched accessories including pre-formed external corner profiles, joint sealants and touch up paint kits to speed installation and enhance the project finish and appearance.

An alternative aluminium corner can also be used for a more contemporary aesthetic.

*Note: not all panels have NichiGuard self cleaning coating – check Technical Data Sheet.

FIGURE 2.01

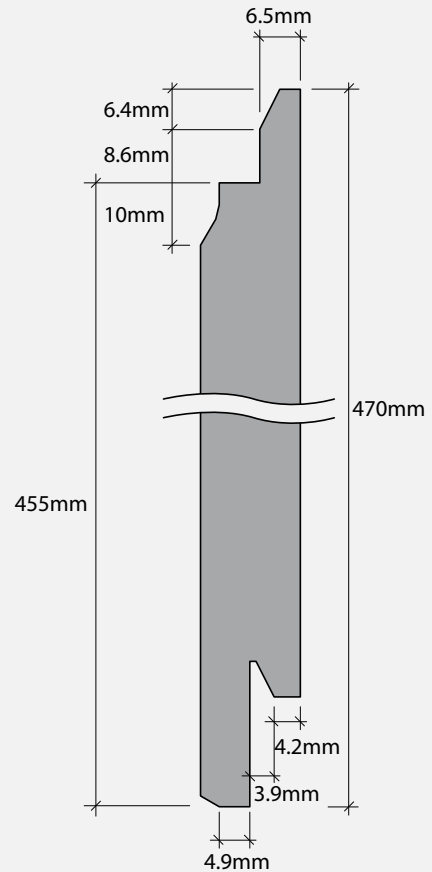

PRODUCT OVERVIEW



NZ Stocked Colour Palette

S = Stocked **I** = Indent

Woodlands



Teak



Grey Gum



Ebony



Jarrah Slats



Kwila Slats



Oakly Slats



Smoked



Cedar



Limed

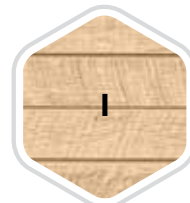

Birch

Quarry



Urban Grey



Concrete



Mottled Rustic Brick



Black Modern Brick



Grey Rustic Brick



White Rustic Brick

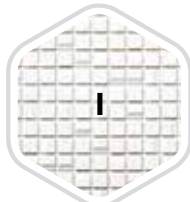

Mosaic White



Mosaic Ivory



Mosaic Brown

Ridge



Black



White



Kings



Katherine



Carnavon

Canyon

Savanna

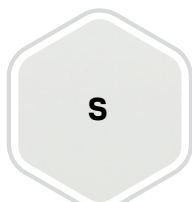

Cloud



Haze

As Territory is a prefinished product, product images may vary from the actual product in regard to colour and surface finish. Panels should be inspected by the owner prior to installation to ensure they meet aesthetic requirements.

Indent only products require additional lead times and have minimum order quantities.

03

SYSTEM OVERVIEW



SYSTEM OVERVIEW



FIGURE 3.01 Cemintel Territory panels are installed with the unique Designer Series clip system – providing a ventilated cavity.

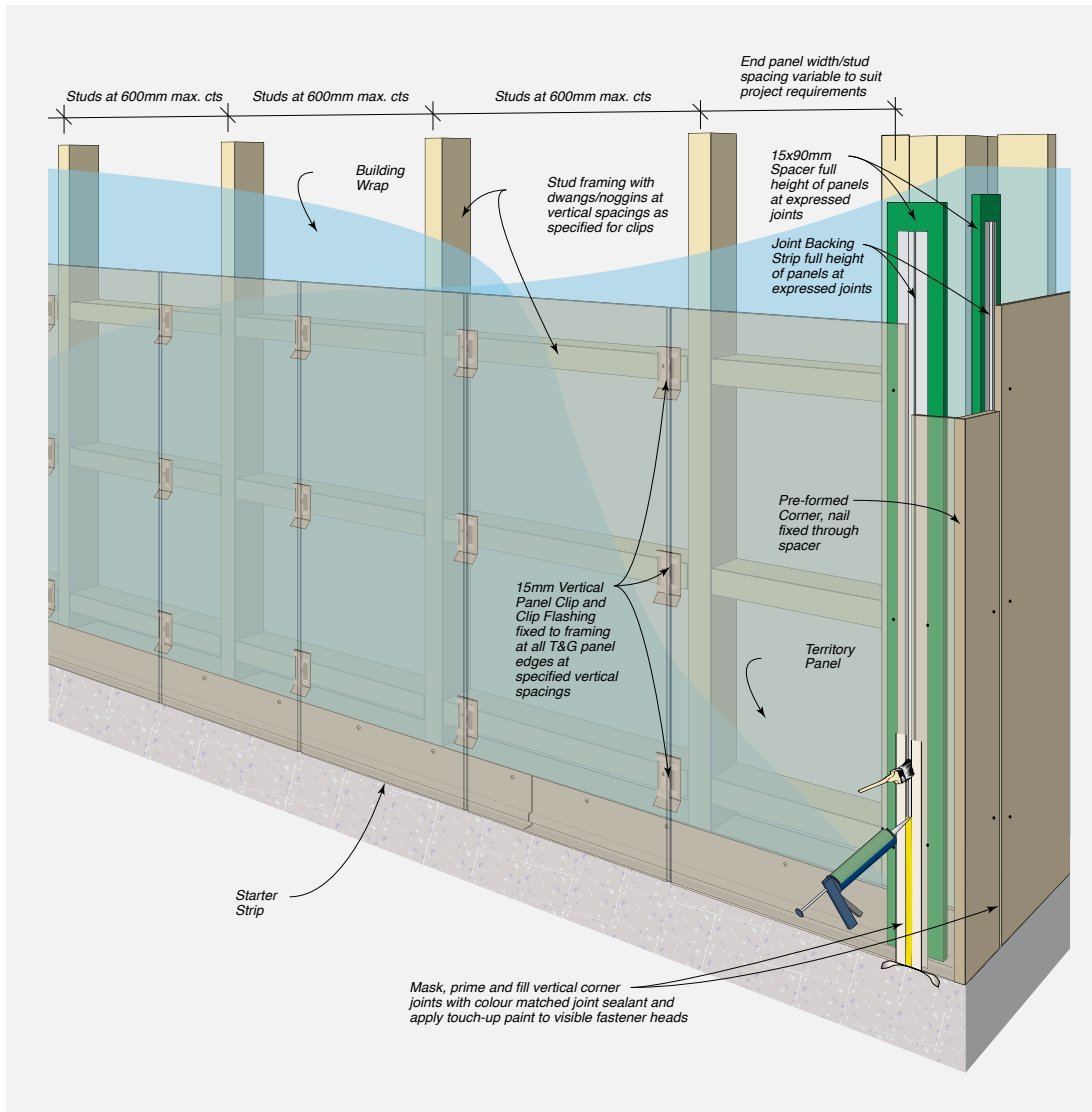

Designer Series clips, together with spacer strips, base starter strips and head vents/eaves trims, create a 15mm cavity behind the Territory panels which allows air flow, ventilation and drainage. This prevents moisture build up and reduces the risk of moisture penetration, allowing the building shell to dry out, creating a healthier, more breathable building.

Aluminium corners can be used as an alternative to the pre-formed corners shown above.

Note: For framing other than 455mm centres, horizontal structure members can be used (eg. top hats and additional timber framing). Contact DesignLink for further information.



03

SYSTEM OVERVIEW



Applications

Cemintel Territory is suitable for all building classes, however, site environmental factors such as wind pressures and corrosivity zones need to be taken into account to determine its suitability for a particular environment.

Codemark Certificate of Conformity No. GM-CM30041 has been obtained for installation to timber, steel and masonry frames. The Certificate confirms compliance with NZ Building Code clauses relating to structure, weather resistance, bushfire construction and thermal resistance.

When installed vertically, the panels and system have been tested to withstand wind pressures up to +2.6kPa and -3.3kPa.



Benefits of the Cemintel Territory System

- Low maintenance.
- No requirement for additional painting costs.
- Potential to speed up the construction process.
- Large format lightweight panels are designed to be fixed to industry standard timber or steel stud structural frames.
- Can also be fixed to masonry.
- Ventilated cavity system allows air flow and drainage.
- Panels are easy to cut for openings eg. around windows and meter boxes.
- Fire Resistance – has been assessed as a Type A cladding.
- Durable and weather resistant;
 - Provides effective protection against wind, rain and temperature extremes, mould and mildew
 - Panels will not rot, swell or warp when correctly installed and maintained
- Suitable for Sea Spray Zone D.

Product Specifications/System Solutions

Dimensional/Geometrical Characteristic	Specification	Manufacturing Tolerance	Relevant Standard
Panel Width	470mm (overall width) 455mm (effective coverage)	+ / - 1mm	JIS A 5422
Panel Length	3030mm	+ / - 1mm	JIS A 5422
Panel Thickness	16mm	+ / - 1.2mm	JIS A 5422
Panel Weight (EMC)	Between 24.6kg and 30kg per panel. Weight varies depending on finish. (Note: 2 panels per pack)		
Fire Safety Cladding Type	Type A		C/VM2 Appendix 2/ ISO 5660
Weatherproofing	Has passed testing for Wind zones up to and including Extra High and a serviceability wind pressure of +1.6 kPa. (Rigid Air Barrier recommended for pressures above 1.5 kPa and Extra High Wind zones)		AS/NZS 4284 & E2/VM1
Wind load	Suitable for use in Wind zones up to and including Extra High and for ultimate wind load of +2.6kPa and -3.3kPa.		AS/NZS 1170.2 & NZS 3604

A technical Data Sheet can be downloaded from cemintel.co.nz

DESIGN + AESTHETIC CONSIDERATIONS



04

DESIGN + AESTHETIC CONSIDERATIONS

This section outlines some important areas for consideration in determining whether Cemintel Territory is suitable for the required application. The following points are not exhaustive. It is the responsibility of the Architect/building designer to ensure the design conforms to NZBC requirements and other relevant building standards that may exist for the location. This guide should be read in conjunction with the NZBC.

Face Fixings

Cemintel Territory is installed largely as a concealed fixing system. The panels are held in place by clips that are screwed to the frame. However, in some places, for example, around openings and corners where clips cannot be fixed, face fixed nails or screws are used. A colour matched touch up paint is available to cover the nails or screws in this instance. (Refer to Fig 1.01). **Do NOT use sealant on nail heads.**

TABLE 4.01 Typical Face Nailing at Square Edge Joint – Front Elevation

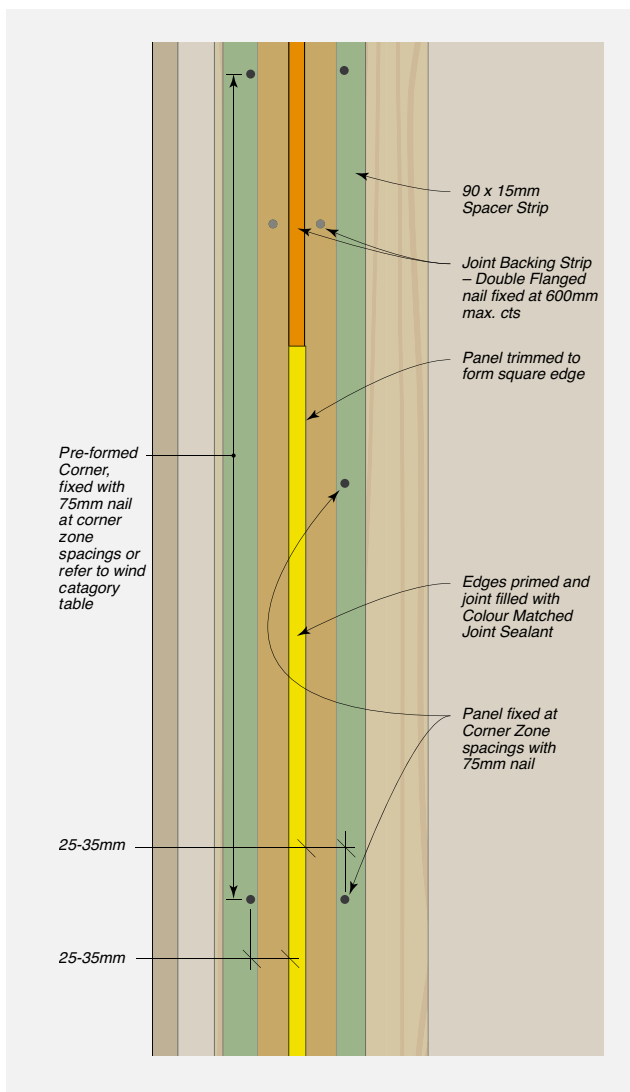

Window & Door Openings

Cemintel Territory is compatible with industry standard aluminium and timber framed windows. Aluminium windows **MUST NOT** have sill drain holes that can direct water into the wall cavity.

With the cavity created by the clip system, particular attention needs to be given to the set out of windows and doors.

The depth of the window needs to be taken into account in the design of the building frame so that the front face of the panel is properly aligned with the window and that the flashing is installed correctly.

A nominal space of 31mm needs to be allowed for a flush finish – taking into account the 15mm cavity (created through the use of the starter strip, clips and spacers) and 16mm panel thickness. This needs to be included in drawings for any project.

If using a rigid air barrier, the thickness of this also needs to be accounted for to achieve a flush finish when determining window set out and reveal depths.

Refer to window detail drawing options in 'Construction Drawings and Details' section of this guide.

Eaves Junction

Options are provided to ensure air circulation through the cavity. A proprietary foam 'L Form Vent' can be concealed behind a traditional timber trim. Alternatively, a coloured metal Eave Trim is available with matching external corner pieces. It is not recommended that air be vented into the roof space.

Corners

The system offers the choice of either pre-formed matching corners or metal corners. In many cases the metal corners are considered easier to install. Note that metal corners are recommended when installing onto masonry.

Not all panels are available with vertical pre-formed corners. Refer to 'Components & Accessories' section for details.

DESIGN + AESTHETIC CONSIDERATIONS



Coverage

A Cemintel Territory panel has a nominal width coverage of 455mm.

Note that the recommended minimum cut panel size is 100mm in length and 200mm in width. Anything under this will most likely result in cracking. **All cut panels must have exposed edges sealed to protect against moisture penetration.**

Panel Coverage Calculator

Territory Panel = 455mm nominal width coverage.

Territory Panel Rows (Width)	Coverage for Full Panels (mm nominal)
19	8645
18	8490
17	7735
16	7280
15	6825
14	6370
13	5915
12	5460
11	5005
10	4550
9	4095
8	3640
7	3185
6	2730
5	2275
4	1820
3	1365
2	910
1	455

NOTE: For vertical panels, the panels at external corners and wall junctions must be trimmed to form a square edge joint. This will reduce the coverage of the first and last panels in a wall.

Control Joints

FIGURE 4.02 Typical Layout of Vertical & Horizontal Panel Joints – Vertical Cladding System

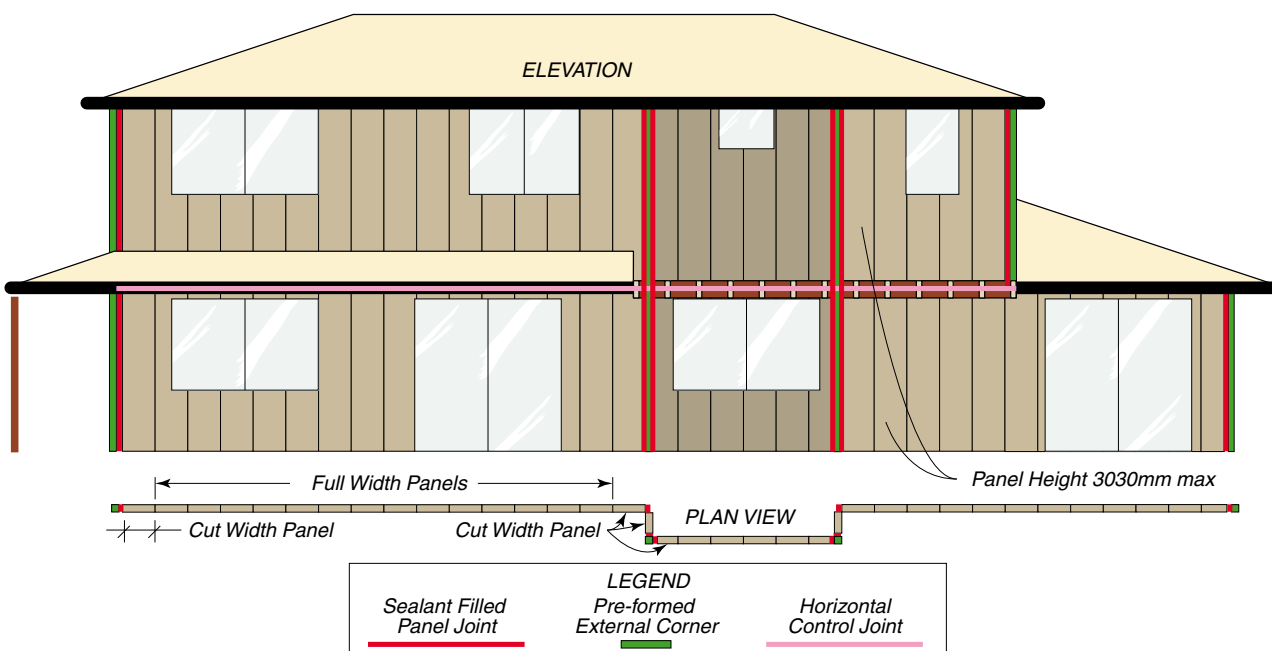



DESIGN + AESTHETIC CONSIDERATIONS

Movement Control Joints

Control joints provided in the panel layout should be aligned with movement control joints provided in the framing. For example, a horizontal control joint of approximately 20-30mm may be required at every slab junction (Refer to Fig 4.02).

When undertaking building additions, a movement control joint must be installed at the junction of the current framing and new framing. The current and new framing and cladding systems must be discontinuous at this control joint. Refer to 'Construction Drawings & Details' section.

When setting out panels, design consideration should be given to the location of joints to ensure that minimum panel lengths and widths are observed.

Horizontal Control Joints

Where frame shrinkage may be a concern, Cemintel NZ recommends creating a horizontal break in the panelling at the first floor level, or by incorporating

a verandah or awning or other design element to create discontinuous panelling. The use of full height windows may assist with aesthetics.

Vertical Control Joints

Vertical sealant filled control joints are required at junctions with the pre-formed corner, and at locations where the Territory wall adjoins another wall type to allow for differential movement. Movement joints provided in framing should be aligned to control joints in the panels. Vertical control joints in panels must extend for the full height of continuous panelling. Refer to 'Construction Drawings & Details' section.

Additional joints may be placed over openings for ease of installation. As the joints are expressed and sealant filled, consideration to the positioning of joints is important for aesthetic reasons. Placing joints at sides or above openings, or the use of full height windows can reduce the visual impact of joints.

Structural

Windload

Wind loads have been calculated in accordance with AS/NZS1170.2 and for wind zones described in NZS 3604. Span tables are provided for timber framing and steel framing, suitable for all New Zealand wind zones and wind pressures of up to +2.6kPa and -3.3kPa.

The tables assume that an interior lining is in place so that only exterior pressures are applied to the cladding. The interior linings must be designed for the appropriate pressures.

Contact Cemintel NZ for information on buildings requiring specific design.

Framing and Substrate Options

Cemintel Territory can be fixed to timber or steel framing as well as to masonry substrates.

For timber and steel framing, the minimum requirement shall be in accordance with the following standards:

- NZS 3604 – Timber Framed Buildings.
- NZS 3404 – Steel Structures.
- AS/NZS4600 – Cold Formed Steel Structures.

The Territory vertical installation has been evaluated

for use in all New Zealand wind zones up to and including Extra High in accordance with NZS3604, and for wind pressures up to +2.6 and -3.3kPa for projects outside the scope of NZS3604.

It is critical that the frame is true and plumb. Industry best practice for frame tolerance is 5mm misalignment over 3000mm.

Note: depending on the chosen panel layout, double studs may be required in some locations. Refer to 'System Engineering' section.

Masonry Installation

Masonry structures are potentially more likely to be out of plumb. This guide provides a fixing solution for masonry however, the top hat has limited ability to allow for variation in the surface plane. Careful assessment should be undertaken to determine if this solution is appropriate for the specific situation.

Span tables are located in 'System Engineering' section.

Structural Bracing

Cemintel Territory panels are indirectly attached to the structural framing using clips and spacers. As a consequence, they are not designed to provide wall bracing.

DESIGN + AESTHETIC CONSIDERATIONS



Bracing must be provided in the structural framing with methods such as sheet or strap bracing. Where sheet bracing is used, the entire wall framing to be clad with Territory panels must be sheathed to maintain a uniform fixing plane. Note: window setout will be affected.

If the building requires a rigid air barrier for weatherproofing purposes (ie higher wind load areas), it is possible to use 6mm fibre cement sheeting as part of the bracing system. Contact Cemintel NZ for options.

Thermal Break

A thermal break with a minimum R-value of R0.25 is required where Cemintel Territory is fixed to steel framing of walls enclosing habitable or usable spaces. The thermal break is applied to the face

of the frame to ensure that the performance of the wall complies to Acceptable Solution E3/AS1 Internal Moisture as condensation control.

Weatherproofing

- The Territory range has been weather tested to E2/VM1 to successfully withstand water ingress for Wind Zones up to and including Extra High. For Extra High wind zones a Rigid Air Barrier is required.
- The Territory range has been weather tested to AS/NZS 4284 to successfully withstand water ingress for serviceability wind loads of up to +1.6kPa and -2.2kPa and to withstand ultimate wind loads of +2.6kPa and -3.3kPa. A specific air barrier is

required and options are available with wall wraps (ultimate wind load up to 1.5kPa) and with a rigid air barrier. Refer to 'System Engineering' Section and Cemintel's Design and Installation Guide for Rigid Air Barrier for further information.

- Windows must be a front draining style and have appropriate flashing to prevent moisture ingress.
- It is important to seal any exposed cut edges to protect against moisture penetration into the panel.

Wall Wrap/Sarking Moisture Management

All buildings require an air barrier to be installed. This may be wall wrap, fibre cement, ply wood or masonry. Installation of fibre cement is detailed in the Cemintel Air Barrier Design and Installation Guide. Masonry substrates must be sealed to act as an air barrier for an effective waterproofing system. For residential buildings in wind zones Low to Very High, wall wrap may generally be used (install as per manufacturer's requirements).

Where the building is in an Extra High wind zone or required to withstand wind loads in excess of 1.5kPa, a rigid air barrier is required in lieu of wall wrap. To ensure occupant comfort and protection of the building frame, the following factors should be considered during the selection of the correct wall wrap:

Building wrap (flexible underlay) is an integral part of the Territory system, and must be combined

with a rigid wall underlay in wind zone Extra High. Wind forces can produce lower air pressures within buildings than on the outside, assisting to force water through gaps in the building envelope such as around penetrations and joints, even at low wind speeds.

The system incorporates a drained cavity, similar to brick veneer construction. This is highly effective at removing condensation and any incidental moisture from the cavity, thereby ensuring that the components within the cavity can dry out.

The underlay must be installed in accordance with the Acceptable Solution E2/AS1. Condensation is a complex problem, and can occur under a variety of conditions, not just cold weather. Literature on this subject is available from CSIRO/BRANZ/ASHRAE/ ABCB and should be consulted when building in areas where condensation is likely to occur.



DESIGN + AESTHETIC CONSIDERATIONS

Insulation and Energy Efficiency

Thermal insulation values for walls must be calculated in order to meet the energy efficiency requirements of NZBC Clause H1.

Calculation tools are available (BRANZ) based on the methods of NZS 4218 for the total insulation values for walls, based on the climate zone (as shown in Appendix B of NZS 4218) and the construction R-values of the building wall elements. Construction R-values should be calculated in accordance with NZS 4214 Methods of determining the total thermal resistance of parts of buildings.

Further information can be found in Acceptable Solution H1/AS1 and the BRANZ House Insulation Guide.

Solar Reflectance/Absorptance

In some states, it is a requirement to provide solar values for coloured product.

Cemintel Territory has been tested by the University of New South Wales to determine Solar Absorption and Reflectance as required by the NZBC. The products have been tested to ASTM E 903-96 'Standard Test Method for Solar Absorptance, Reflectance and Transmittance of Materials Using Integrating Spheres'.

Current values are included in the Technical Data Sheet.

Other Design Considerations

Penetrations

Penetrations in the Territory panels must be neatly cut using appropriate tools such as a saw, drill or hole saw.

Penetrations should be prepared with a clearance of 8-10mm all around and the gap must be fully sealed

Corrosive Zones

Consideration of corrosivity zones should be taken into account. While Territory panels are not susceptible to corrosion, consideration needs to be made regarding the impact of climate conditions on system components such as fasteners, clips and metal framing, for example.

Corrosivity zones are described in NZS 3604, with further information available in AS/NZS 2728 and E2/AS1. It is recommended that the building designer assess the site in accordance with the standards and local conditions to determine suitability of the system.

The Territory system may be used in zones B, C and D except for fixing to masonry which is limited to zones B & C. The System is not suitable for use in Zone E or in industrial and geothermal areas where the environment may be acidic with a pH of less than 5.

The system should not be used in aggressive industrial areas where the environment may be acidic with a pH of less than 5.

In all zones, all walls which are protected by soffits above must be washed down twice per year, to remove salt and debris buildup, particularly around window/door openings.

Temperature Extremes

Territory panels are not warranted for use in freezing conditions in which panels are in contact with snow or extremely hot temperatures (above 50°C).

with sealant.

Elements that cross the cavity must not allow water to transfer to the building wrap, for example, by angling them down to the cladding.

Renovations and Additions

When undertaking building renovations, remove all

DESIGN + AESTHETIC CONSIDERATIONS



cladding and wall wrap/sarking and insulation from the original wall framing. Ensure the condition of the framing is in accordance with current requirements and is as true and as plumb as possible (within accepted industry tolerance of 5mm misalignment over 3000mm).

Install additional framing as required, insulation, wall air barrier and flashing.

When undertaking building additions, a movement control joint must be installed at the junction of the current framing and new framing. The current and new framing and cladding systems must be discontinuous at this control joint.

Limitations

The Territory system is NOT suitable for the following applications: Panels with non-vertical face (e.g. Parapet Capping); wet areas such as bathrooms and water features; exposure to temperatures over 50°C; non-vented parapet cladding; contact with standing snow or ice. Do NOT apply tiles or other materials to the face of the panels.

Fire Safety Requirements

All cladding for buildings over 7m high requires a fire test in accordance with ISO 5660. Territory panels have been tested by BRANZ to achieve a 'Type A' Cladding Type. This allows Territory panels to be installed on buildings above 7m to achieve fire safety requirements. Cemintel NZ also recommend installing horizontal cavity barriers to reduce the risk of fire spread via the facade. Cavity barriers must not block water drainage or air flow paths.

It is the responsibility of the building designer, architect or engineer to meet these requirements.

Territory QUARRY Urban Grey

Note that the Territory QUARRY Urban Grey panel has "dimples" across the surface to replicate the look of formwork and these need to be considered in the design phase. Extra product may need to be ordered accordingly. The Territory QUARRY Concrete has the same colour/finish but has a flat profile (ie no "dimples").

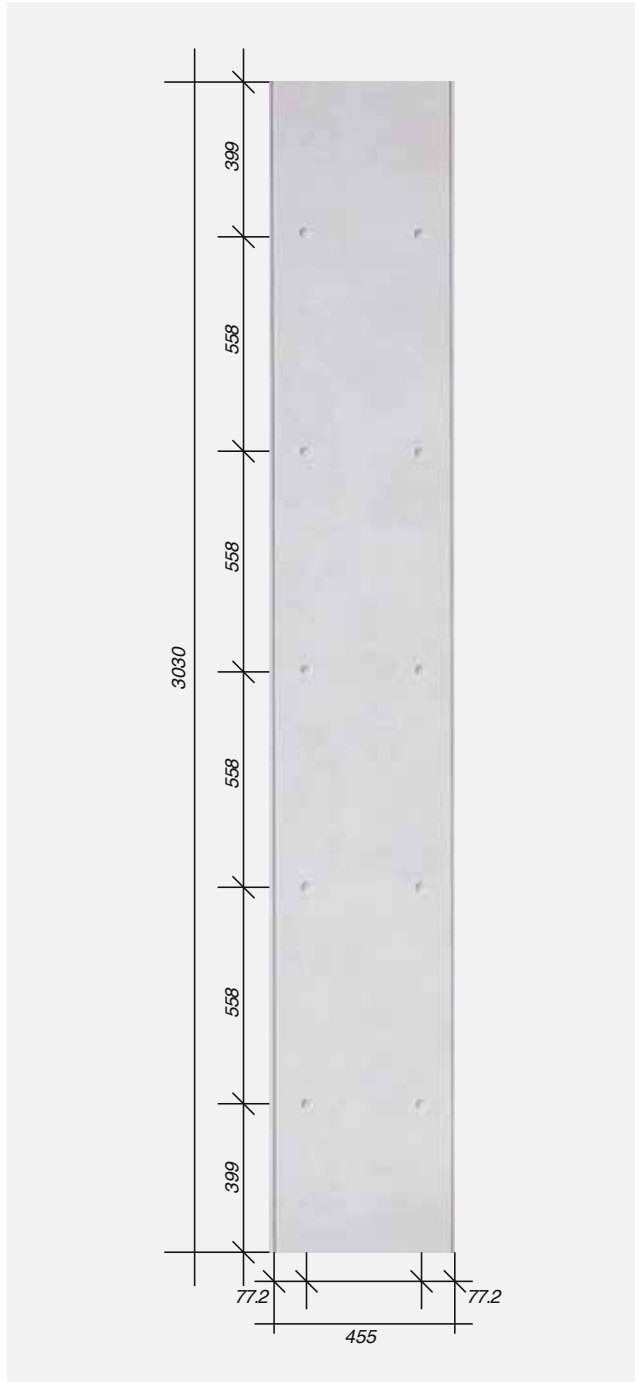

05

COMPONENTS + ACCESSORIES

COMPONENTS + ACCESSORIES



Note: Codes can change from time to time. Refer to the website for the current list of components prior to ordering.

Cemintel Territory Panels and Colour Matched Accessories

Product Name - NZ Stocked range	Panel (2 Pk)	Touch-Up Paint*	Primer	Pre-formed External Corner #
WOODLANDS Teak	140795	159051	128124	140798
WOODLANDS Grey Gum	472438	474625	128124	472456
WOODLANDS Ebony	140797	159052	128124	140800
WOODLANDS Jarrah Slats	472440	474628	128124	472458
WOODLANDS Kwila Slats	472441	474629	186527	472459
WOODLANDS Oaky Slats	472442	474630	128124	472460
QUARRY Urban Grey	128087	159040	128124	128114
QUARRY Concrete	151949	159040	128124	128114
QUARRY Mottled Rustic Brick	472444	474631	128124	472462
QUARRY Black Modern Brick	472446	474632	128124	472464
RIDGE Black	472454	474636	186527	472472
RIDGE White	472455	474635	128124	472473
CANYON Kings	472451	474641	128124	472469
CANYON Katherine	472452	474640	128124	472470
CANYON Carnavon	472450	474642	128124	472468
SAVANNA Cloud	128082	159034	128124	128088
SAVANNA Haze	128084	159035	128124	128111







Product Name - Indent Only Range	Panel (2 Pk)	Touch-Up Paint*	Primer	Pre-formed External Corner #
WOODLANDS Smoked	186444	186456	128124	186484
WOODLANDS Cedar	472434	474627	186527	472435
WOODLANDS Limed	186446	186458	128124	186486
WOODLANDS Birch	472439	474626	186527	472457
QUARRY Grey Rustic Brick	472445	474634	128124	472463
QUARRY White Rustic Brick	472443	474633	128124	472461
QUARRY Mosaic White	472448	474637	128124	472466
QUARRY Mosaic Ivory	472449	474638	128124	472467
QUARRY Mosaic Brown	472447	474639	186527	472465

*Touch-Up Paint - use for nail heads, cut edges at window heads and other visible blemishes.

If 304 nail heads require coating, use a primer for bare steel such as Dulux All Metal Primer prior to coating with the appropriate colour matched paint.

#Pre-formed External Corners are manufactured to match panels. Internal measurement - 70mm x 70mm. Coverage nominal 86mm x 86mm x 455mm.

Other Accessories/Tools

Accessories	Description	Size	Quantity	Product Code
	Screws for timber framing – used to fix starter strip, clips and other components. Stainless steel 410 grade and clear coated.	35mm	250 per pack	128145
	Screws for timber framing – for fixing components over materials such as rigid air barrier or bracing sheet. Galvanised steel, Cat5 ArmaGalv.	63mm	250 per pack	186524
	Nails for timber framing – for fixing Territory panels at soffit line and other locations where required. Ribbed shank, flat head, stainless steel 304 grade. Pre-drill panels for all nails.	75mm	115 per pack	128147
	Screws for steel framing – for fixing starter strip, clips and other components. Cat5 ArmaGalv, 8g, self-drilling, button head, Phillips drive.	40mm	250 per pack	165681
	Screws for steel framing – for face fixing Territory panels at soffit line and other specified locations. Cat5 ArmaGalv, self-drilling, CSK self-embedding head, Phillips drive. Suitable for 0.75mm BMT steel framing.	75mm	100 per pack	165683
	Screws for masonry framing – for fixing start strip, clips and other components onto Rondo H515 Top Hats. Class 3, 8g, self-drilling, wafer head, Phillips drive	12mm	100 per pack	By Others
	Screws for masonry framing – for face fixing panels at soffit line and other locations where required onto Rondo H515 Top Hats. Cat5 ArmaGalv, self-drilling, CSK self-embedding head, Square drive. Also used for fixing panel to metal corner.	45mm	100 per pack	186526

05

COMPONENTS + ACCESSORIES







Note: Codes can change from time to time. Refer to the website for the current list of components prior to ordering.

Accessories	Description	Size	Quantity	Product Code
	Fasteners – to fix backing strip and other components to framing. <ul style="list-style-type: none"> For fixing to timber framing – galvanised clout, 40 x 1.6mm For fixing to steel framing – button head screws, class 3, 6g x 40mm self-drilling, Phillips drive For fixing to H515 Top Hat – button head screws 8g, self-drilling, Phillips drive, 12mm for fixing starter strip and clip 		By Others	
	Vertical Base Starter Strip – Steel profile used at the base to locate the first row of panels. Manufactured from 1.2mm BMT steel with Galvalume AZ150 corrosion resistant coating.	95mm x 23mm x 3000mm	1 each	140831
	Vertical Starter Strip – steel profile used at the base to locate the first row of panels. Provides 15mm offset from face of studs. Manufactured from 1.2BMT steel with Galvalume AZ150 corrosion resistant coating	3030mm	1 each	140816
	Vertical Panel Clip – fixed to the framing to retain the tongue and groove edges of panels. Manufactured from SuperDyma corrosion resistant coated steel.	62mm x 45mm x 15mm	50 per pack	140819
	Vertical Panel Clip Flashing – Used behind each Panel Clip. Galvalume AZ150 corrosion resistant coating.	50mm x 60mm	Pack of 200	141266
	90mm Vertical Spacer – for use with metal corners.	15mm x 90mm x 2000mm	1 each	140818
	50mm Horizontal Spacer – for packing between framing and panels at eaves and other locations wherever face fixing is required. Manufactured in extruded plastic.	15mm x 50mm x 1200mm	1 each	128136
	Steel Top Hat – for framing on masonry substrate. Rondo H515. Manufactured from galvanised (Z275) 1.15mm BMT steel. Requires screws 8G, self-drilling, button head, Phillips drive 12mm for fixing starter strip and short [and long] clips to H515 Top Hat. Suitable for corrosion zones B & C only.	80mm x 15mm with 500mm face 0.91 kg/m	1 each – 3.6m 1 each – 7.2m	Supplied by others
	Eaves Trim – Provides an attractive finish at eaves junction and provides cavity ventilation. Powder coated finish on 1.0mm Aluminium.	60 x 26 x 3030mm	1 each White Black	192871 192859
	Eaves Trim External Corner – provides joint at external eaves trim corner. Powder coated finish on 1.0mm Aluminium.	100mm x 100mm	Pack of 4 White Black	192878 192874
	Eaves Trim Internal Corner – provides joint at internal eaves trim corner. Powder coated finish on 1.0mm Aluminium.	100mm x 100mm	Pack of 4 White Black	192879 192875
	Soffit Trim – provides finish at soffit edge as well as cavity ventilation and cavity closure below battens. Powder coated finish on 0.35mm BMT steel with Galvalume AZ150 corrosion resistant coating.	3030mm	1 each White	159421
	Soffit Trim External Corner – provides joint at soffit trim corner. Powder coated finish on 0.35mm BMT steel with Galvalume AZ150 corrosion resistant coating.		White	159422
	Soffit Trim Internal Corner – provides joint at soffit trim corner. Powder coated finish on 0.35mm BMT steel with Galvalume AZ150 corrosion resistant coating.	135206	Pack of 2 White	159423

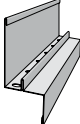
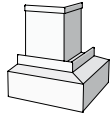
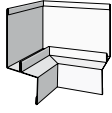

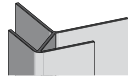

COMPONENTS + ACCESSORIES

05

Note: Codes can change from time to time. Refer to the website for the current list of components prior to ordering.

	Control Joint Flashing – Provides an attractive finish at horizontal control joints and provides cavity ventilation where more than one panel high is installed. Powder coat finish on 0.35mm BMT steel with Galvalume AZ150 corrosion resistant coating.	35 x 90.5mm x 3030mmL	1 each Bronze Silver White	140822 140824 140823
	Control Joint External Corner – Provides attractive corner junction where more than one panel high is installed. Powder coat finish on 0.35mm BMT steel with Galvalume AZ150 corrosion resistant coating.	85 x 85mm	Pack of 4 Bronze Silver White	140828 140830 140829
	Control Joint Internal Corner – Provides attractive corner junction where more than one panel high is installed. Powder coat finish on 0.35mm BMT steel with Galvalume AZ150 corrosion resistant coating. 85 x 85mm	85 x 85mm	Pack of 4 Bronze Silver White	140825 140827 140826
	Joint Backing Strip Double Flange – used at vertical joint where preformed corner is installed to fill cavity and provide a backing for sealant. Manufactured in 0.3mm BMT steel with Galvalume AZ150 corrosion resistant and bond breaker coating. Forms 10mm wide express joint.	20/10/20 x 5 x 3030mm	1 each	140820
	Joint Backing Strip Single Flange – used at vertical internal corner joints and at openings to fill cavity and provide a backing for sealant. Manufactured in 0.3mm BMT steel with Galvalume AZ150 corrosion resistant and bond breaker coating.	10/45 x 5 x 2000mm	1 each	140821
	Internal Corner Flashing – metal angle flashing used in some corners. Manufactured from steel with Galvalume AZ150 corrosion resistant coating.	50mm x 50mm x 2400mm	1 each	128140
	Cavity Closure – UPVC profile used above windows, doors and similar openings as a vermin barrier.	50mm x 15mm x 3000mm	1 each	128142
	External aluminium corner trim – anodised aluminium extrusion used to dress and finish external corners.	60mm x 65mm x 3030mm	1 each Silver	128117
	L-Form Cavity Vent – used at parapet and horizontal control joints to provide air flow while maintaining vermin proofing. Has self-adhesive EPDM tape for fixing into flashing/capping and compressible foam filler attached internally.	1200mm	1 each	134770
	Cemintel Edge Sealer – for sealing panel edges after on-site cutting.	200ml	1 each	186529
	Territory Putty – Putty required to patch exposed fixings on Smartfit Windows or fill holes in Territory panels.	330mL	1 each	176474

Tools

Product	Description	Size	Quantity	Product Code
	Cemintel Power Saw Blade – specifically designed for cutting pre-finished cement based sheets. Ideal for use with dustless circular saws fitted with vacuum extraction systems. 15000 RPM max.	125mm	1	154461
	Makita Plunge Saw Kit (1300W) includes 1400mm guide rail and bonus 165mm fibre cement saw blade – excellent for cutting cement based sheets	165mm	1	Supplied by others
	Makita 165mm Fibre Cement Saw Blade – ideal for use with the Makita Plunge saw and other 165mm circular saws fitted with vacuum extraction systems	165mmx20x4T	1	Supplied by others
	FESTOOL DSC-AGP 125 – Diamond Blade Cutting and Grinding Tool. Used to provide neat and accurate bevelled edges	125mm	1	Supplied by others
	FESTOOL TS 55 EBO Plunge Cut Saw – with 1400mm Guide Rail. Precise plunge cuts in materials up to 55mm thick.	160mm	1	Supplied by others
	FESTOOL Diamond Tipped Blade for TS 55 – for cutting all fibre cement sheet products	160mm	1	Supplied by others



SYSTEM ENGINEERING

SYSTEM ENGINEERING



Design, Detailing And Performance Responsibilities

Cemintel engages independent testing laboratories to test and report on the performance of a wall in accordance with the relevant New Zealand Standards. Consultants use these reports as the basis for opinions (estimates of laboratory performance) they issue for variations to the tested system. Using their experience, the consultant will make judgments about on-site installed performance of various walls. The performance levels of walls documented in this guide are either what is reported in a test or the documented opinion of consultants. Performance in projects is typically the responsibility of:

Project Consultants (Structural, Fire, Acoustic, Etc.)

These consultants are typically responsible for the following:

- Opinions on expected laboratory performance of wall configurations that vary from actual test configuration, such as substitution products and components.
- Judgements about expected field performance using laboratory test reports and practical experience.
- Design, specification and certification of structural, fire, acoustic, durability, weather tightness and any other required performance criteria for individual projects.

This involves the design and selection of building elements, such as wall and floors and their integration into the building considering the following:

- Interface of different building elements and to the structure / substrate.
- Wall and floor junctions.
- Penetrations.
- Flashing design.
- Room / building geometry.
- Acoustic and water penetration field-testing.

Project Certifier and/or Builder

These professionals are typically responsible for:

- Identifying the performance requirements for the project in accordance with the NZBC and clearly communicating this to the relevant parties.
- Applicability of any performance characteristics supplied by Cemintel including test and opinions for the project.
- The project consultant's responsibilities detailed above if they are not appointed.

Cemintel NZ does not provide consulting services. Cemintel NZ only provides information that has been prepared by others and therefore shall not be considered experts in the field.

Any party using the information contained in this guide or supplied by Cemintel NZ in the course of a project must satisfy themselves that it is true, current and appropriate for the application, consequently accepting responsibility for its use.

It is the responsibility of the architectural designer and engineering parties to ensure that the details in this design guide are appropriate for the intended application.

The recommendations in this guide are formulated along the lines of good building practice, but are not intended to be an exhaustive statement of all relevant data.

Cemintel NZ is not responsible for the performance of constructed walls, including field performance, and does not interpret or make judgements about performance requirements in the NZBC.



SYSTEM ENGINEERING

Span Tables / Wind Loads

Timber Framing – RESIDENTIAL

TABLE 6.01 Fixing Requirements for Territory Vertical Panels – based on wind classification – studs at 455mm centres maximum centres

Wind Classification (NZS3604)	PANEL ZONE Minimum Fixing Requirements for areas greater than 1200mm from an external building corner	CORNER ZONE Minimum Fixing Requirements for areas less than 1200mm from an external building corner
Low	Clips @ 600 cts	Clips @ 600 cts
Medium	Clips @ 600 cts	Clips @ 600 cts
High	Clips @ 600 cts	Clips @ 450 cts
Very High	Clips @ 600 cts	Clips @ 450 cts
Extra High	Clips @ 600 cts	Clips @ 300 cts

Timber Framing – COMMERCIAL & OTHER

TABLE 6.02 Territory Fixing Requirements for timber framing – based on wind pressures.

Design Wind Pressure (Ultimate) (kPa)	Minimum Fixing Requirements
0 - 1	Clip @ 600mm cts
1 - 1.5	Clip @ 450mm cts
1.5 - 3.0	Clip @ 300mm cts

Note: Design wind pressures apply to both negative and positive pressures.

SYSTEM ENGINEERING

**Steel Framing – RESIDENTIAL****TABLE 6.03** Fixing Requirements for Territory Vertical Panels – Steel Framing – Studs at 455mm centres max.

Wind Classification (NZS3604)	PANEL ZONE – Minimum Fixing Requirements for areas greater than 1200mm from an External Building Corner		
	Steel Frame Metal Thickness		
	0.55mm	0.75mm	1.15mm
Low	Clips @ 600 cts	Clips @ 600 cts	Clips @ 600 cts
Medium	Clips @ 600 cts	Clips @ 600 cts	Clips @ 600 cts
High	Clips @ 600 cts	Clips @ 600 cts	Clips @ 600 cts
Very High	Clips @ 600 cts	Clips @ 600 cts	Clips @ 600 cts
Extra High	Clips @ 450 cts	Clips @ 600 cts	Clips @ 600 cts

Wind Classification (NZS3604)	CORNER ZONE – Minimum Fixing Requirements for areas greater than 1200mm from an External Building Corner		
	Steel Frame Metal Thickness		
	0.55mm	0.75mm	1.15mm
Low	Clips @ 600 cts	Clips @ 600 cts	Clips @ 600 cts
Medium	Clips @ 600 cts	Clips @ 600 cts	Clips @ 600 cts
High	Clips @ 450 cts	Clips @ 600 cts	Clips @ 600 cts
Very High		Clips @ 600 cts	Clips @ 600 cts
Extra High		Clips @ 450 cts	Clips @ 600 cts

Note: System performance relies on the use of Territory approved fasteners. Table based on external pressures only, with internal linings designed to resist internal pressures.

Steel Framing – COMMERCIAL & OTHER**TABLE 6.04** Territory Fixing Requirements for steel framing – based on wind pressures.

Design Wind Pressure (Ultimate) (kPa)	Minimum Fixing Requirements		
	Steel Frame Metal Thickness		
	0.55mm	0.75mm	1.15mm
1	Clips @ 600mm cts	Clips @ 600mm cts	Clips @ 600mm cts
1.5	Clips @ 450mm cts	Clips @ 600mm cts	Clips @ 600mm cts
2	Clips @ 300mm cts	Clips @ 600mm cts	Clips @ 600mm cts
2.5	NA	Clips @ 450mm cts	Clips @ 600mm cts
3	NA	Clips @ 300mm cts	Clips @ 450mm cts
3.3	NA	Clips @ 300mm cts	Clips @ 300mm cts



SYSTEM ENGINEERING

Masonry Substrates

Masonry wall must be structural and constructed from brick, concrete or concrete block in accordance with the relevant building codes. It is important the wall is plumb and true. Note the H515 Top Hat will not cater for much variation across the plane of the surface. Masonry fasteners must be designed by the project engineer.

Masonry – Residential

TABLE 6.05

Wind Classification (NZS3604)	PANEL ZONE Minimum Fixing Requirements for areas greater than 1200mm from an external building corner	CORNER ZONE Minimum Fixing Requirements for areas less than 1200mm from an external building corner
Low	Clips @ 600 cts	Clips @ 600 cts
Medium	Clips @ 600 cts	Clips @ 600 cts
High	Clips @ 600 cts	Clips @ 600 cts
Very High	Clips @ 600 cts	Clips @ 600 cts
Extra High	Clips @ 600 cts	Clips @ 450 cts

Maximum H515 Top Hat spacing as per clip fixing centres.

Masonry – COMMERCIAL

TABLE 6.06

Design Wind Pressure (Ultimate) (kPa)	Minimum Fixing Requirements (Top Hats & Clip)
1	Clips @ 600mm cts
1.5	Clips @ 600mm cts
2	Clips @ 600mm cts
2.5	Clips @ 600mm cts
3	Clips @ 450mm cts
3.3	Clips @ 300mm cts

Maximum H515 Top Hat spacing as per clip fixing centres.

07

INSTALLATION

07

INSTALLATION

CHECKLIST – Prior to Installation

The following pre-install checklist may assist to ensure you have the best possible outcome when using Cemintel Territory.

- Ensure substrate is straight and plumb. Pack studs to straighten if necessary (timber frames as per NZS3604, steel frames as per NZS3404 or AS/NZS4600) industry best practice for frame tolerance is 5mm misalignment over 3000mm.
- Ensure studs are correctly located and of the appropriate thickness.
- Confirm bracing is in place. Where sheet bracing is used behind panels, the entire wall area needs to be braced or bracing sheet packers fixed to the frame to ensure a uniform fixing plane.
- Remove any concrete that may foul the cladding line, particularly at steps in slabs and isolated columns.
- Ensure there is adequate ground clearance to the bottom edge of the Territory panels as per regulatory requirements.
- Confirm your panel layout to determine the location of joints and identify where additional studs are required.
 - If using pre-formed corners, studs need to be located to allow face fixing to support the corners.
 - Additional studs or blocking may be required for support and fixing of Territory joint backing strips at corners and junctions.
- Flashings, membranes and air barrier should be correctly installed, overlapped and taped at joints, prior to fixing panels. In the case of fixing to masonry, the top hats should be installed correctly. (Wall wrap is not required when installing over masonry.)
- Install windows so that the back of the front face of the window (or any other protrusions including doors or meter boxes) will be flush with the face of the panels.
- Where there is no space to use a mounting clip along the bottom and top edge of the window, tack a horizontal green spacer to provide a firm surface for the cladding panel to maintain its position.
- Fit Head flashings over windows, doors and other penetrations.
- Confirm the chosen eaves/soffit details and prepare accordingly.
- Consider the need for structural support for fixtures such as pergolas and decking. No loads may be carried by the cladding.
- Confirm membranes and flashings for deck areas have been installed in accordance with manufacturers' specifications.
- Arrange for a pre-cladding inspection by the appropriate local building authority if required.



Check quality and quantity of panels and components before installing. If there is any sign of damage or visible defects in panels, or the colour/finish is not in keeping with the owners aesthetic requirements **DO NOT INSTALL.** Contact Cemintel to address any issues.

Installation Set-Out

Timber Framing

Vertical panel installation requires a square vertical edge to the panel at junctions with a Territory pre-formed corner or metal corner trim, at internal corners and at junctions with masonry or other wall systems. This requires removal of the tongue or groove from one edge of the end panels. These panels can be trimmed to between 200mm and 430mm nominal cover. These panel widths should be considered when panel joint location is important for aesthetics. See Fig 7.01 and 7.02.

Panel Fixing

All face fixings must be backed and supported by the Territory 15mm spacer.

Panels must be fixed to the structural framing along trimmed panel edges with Territory 75mm nails at 20-35mm from the panel edge for timber framing or with Territory 55mm screws at 30-40mm from the panel edge for steel framing. Fasteners are to be placed at the same maximum spacings as specified for clips.

FIGURE 7.01 Non-Symmetrical Panel Set-out – Timber Framing

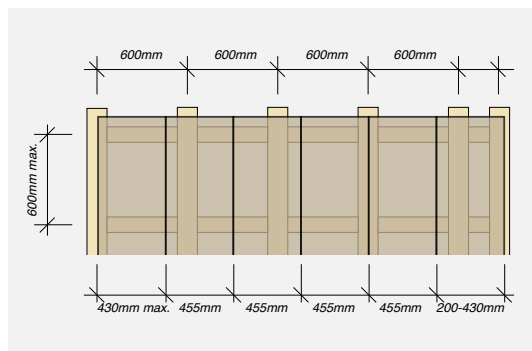

FIGURE 7.02 Symmetrical Panel Set-out – Timber Framing

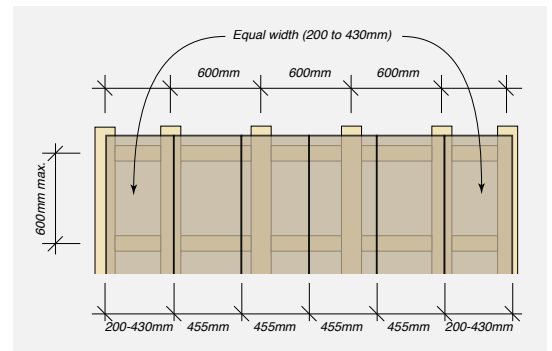
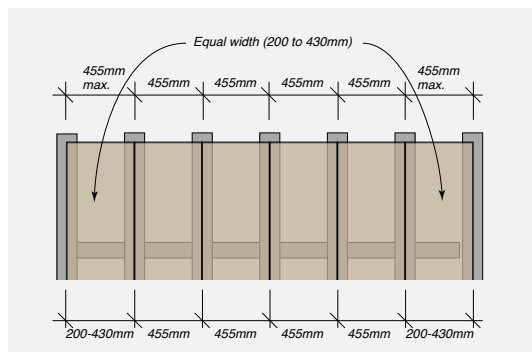

FIGURE 7.03 Symmetrical Panel Set-out – Steel Framing



Note: For framing other than 455mm centres, horizontal structure members can be used (eg. top hats and additional timber framing). Contact DesignLink for further information.

07

INSTALLATION

Timber Framing

All framing must be in accordance with the following NZS 3604.

Standard framing techniques are appropriate for the vertical panel system.

FIGURE 7.04 Typical Framing Set-Out with 90mm Timber Framing and Territory Pre-formed Corners – Plan View

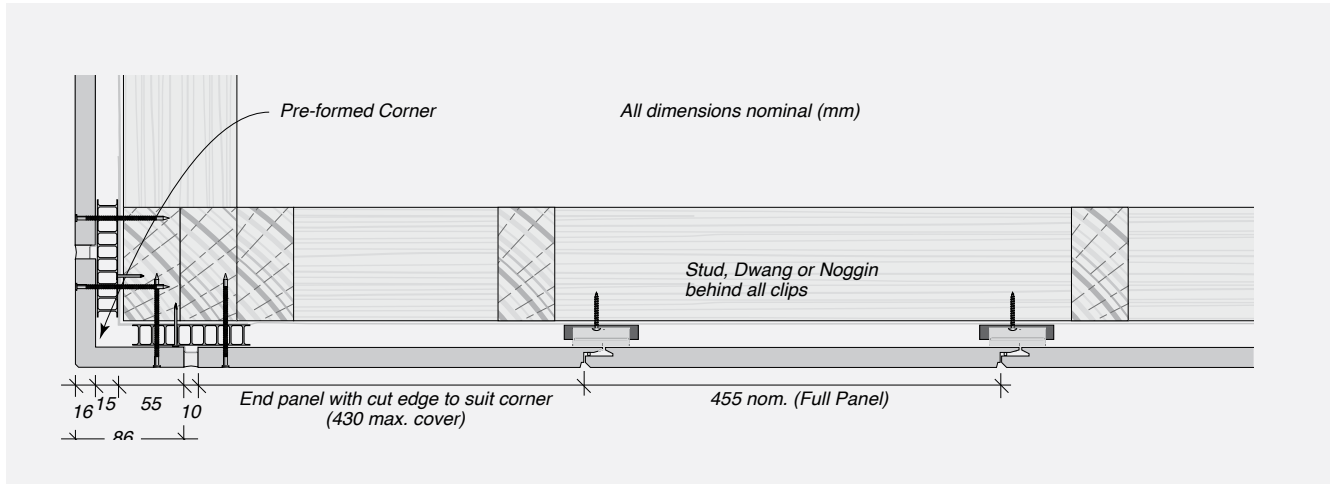
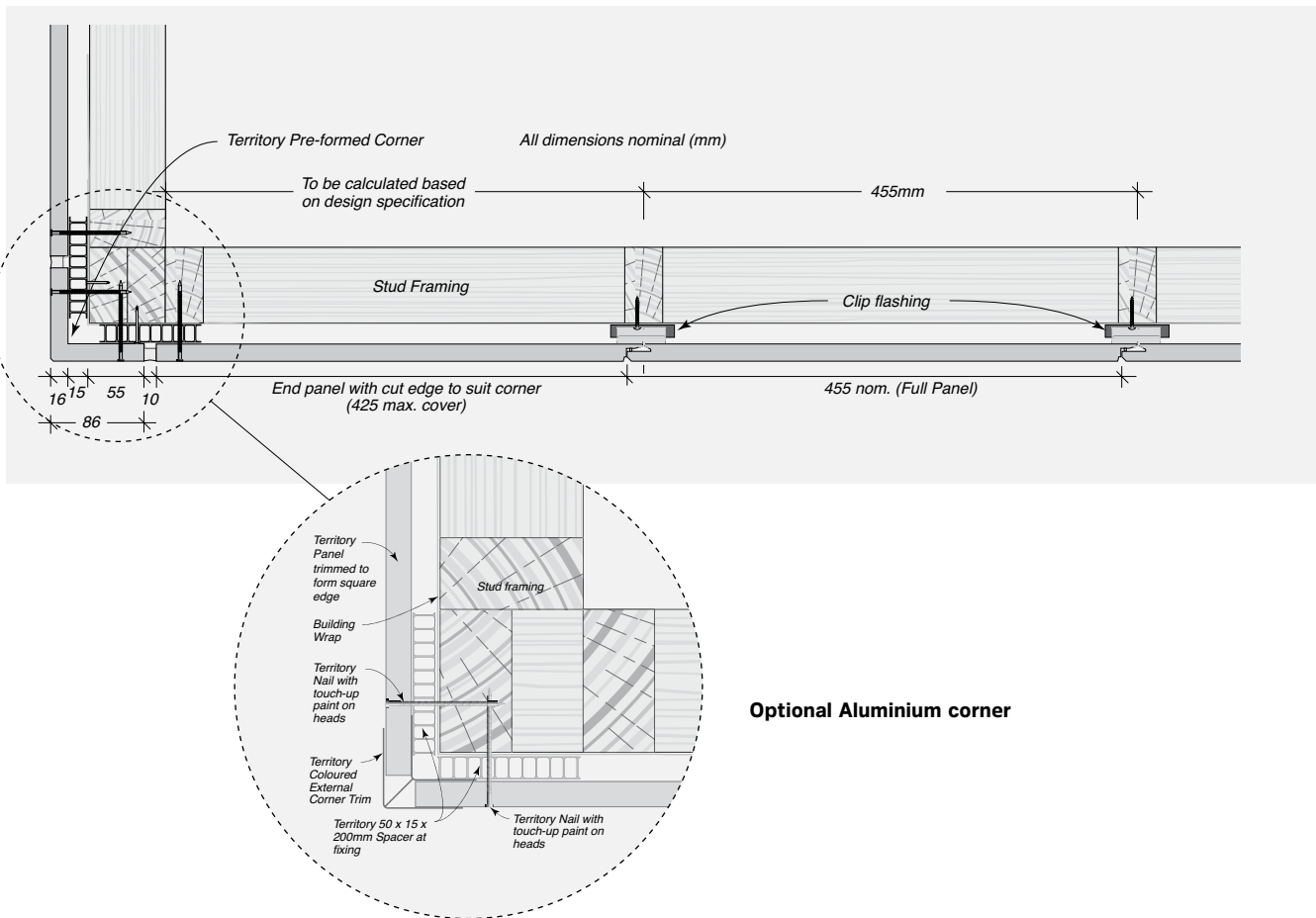

FIGURE 7.05 Typical Framing Set-Out with 70mm Timber Framing and Territory Pre-formed Corners – Plan View



INSTALLATION



FIGURE 7.06 Typical Territory System Cross Section - Elevation

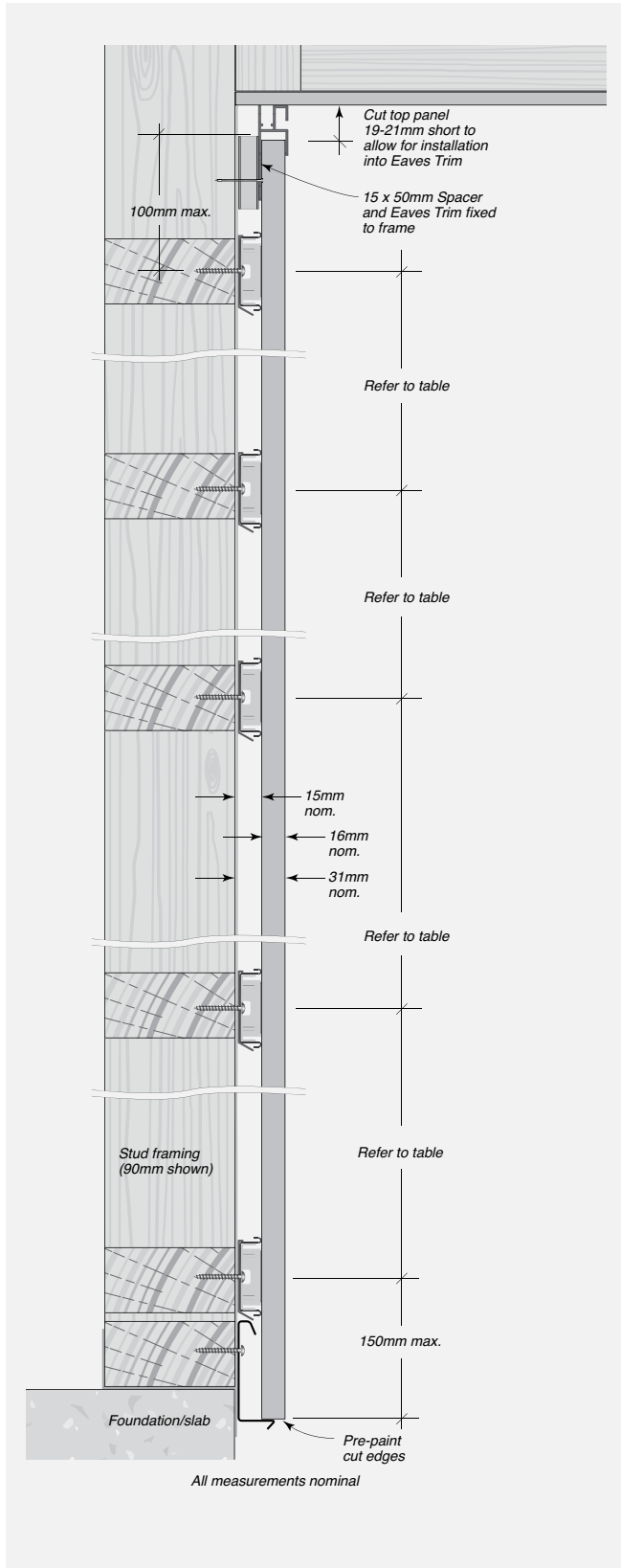
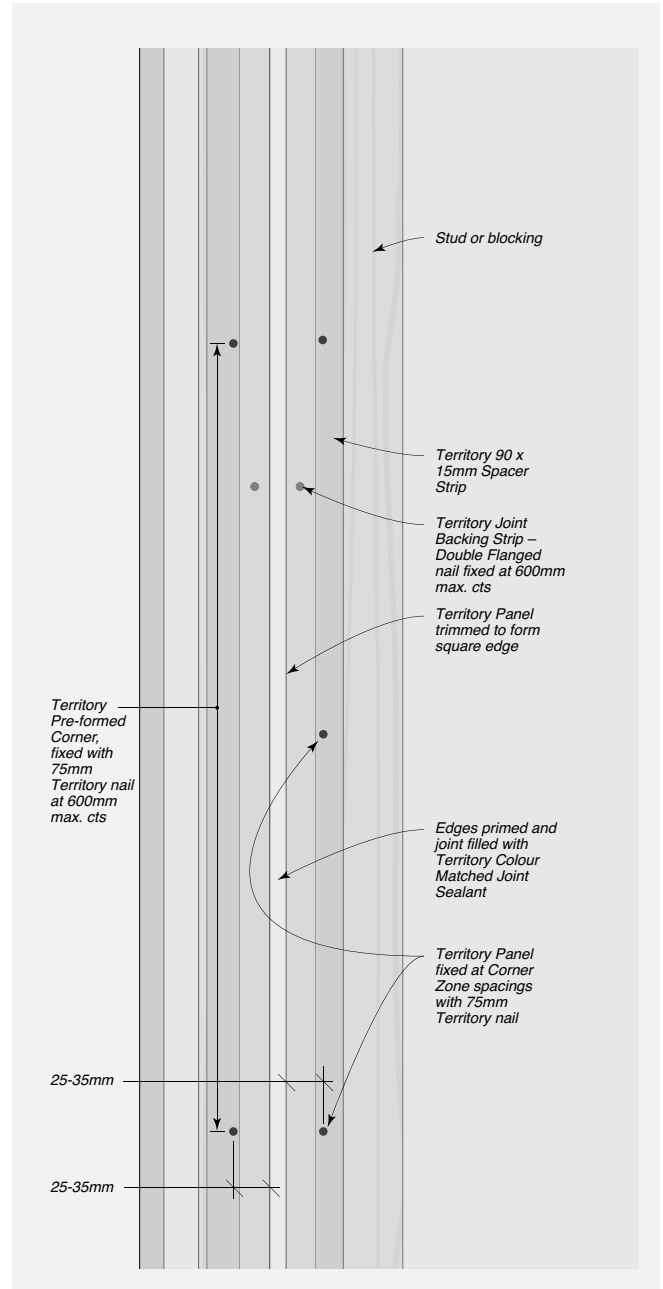

FIGURE 7.07 Typical Face Nailing at Square Edge Joint - Elevation



07

INSTALLATION

Steel Framing

Steel framing must be in accordance with AS/NZ4600 or NZS 3404.

FIGURE 7.08 Typical Framing Set-Out with 90mm Steel Framing and Territory Pre-formed Corners – Plan View

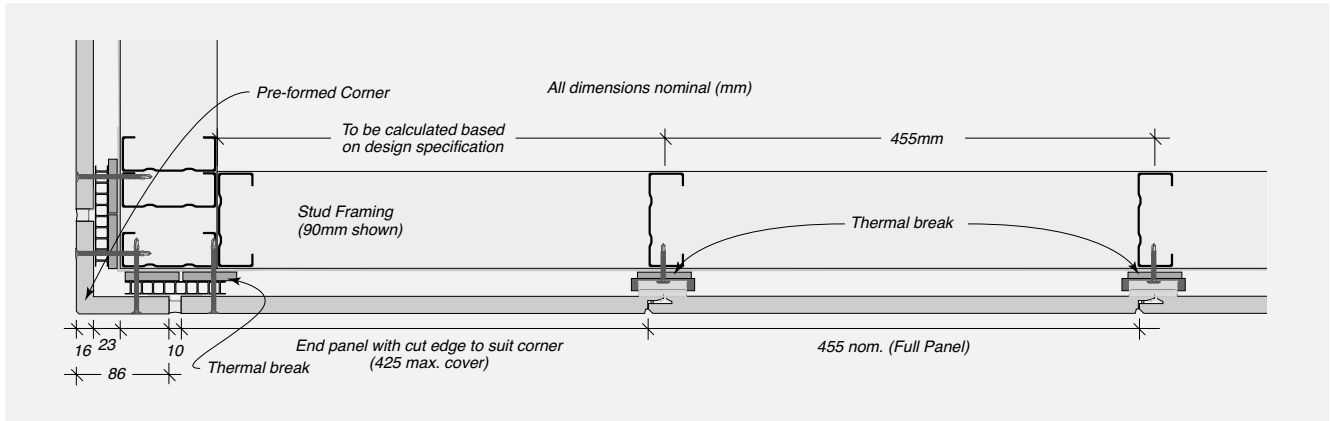
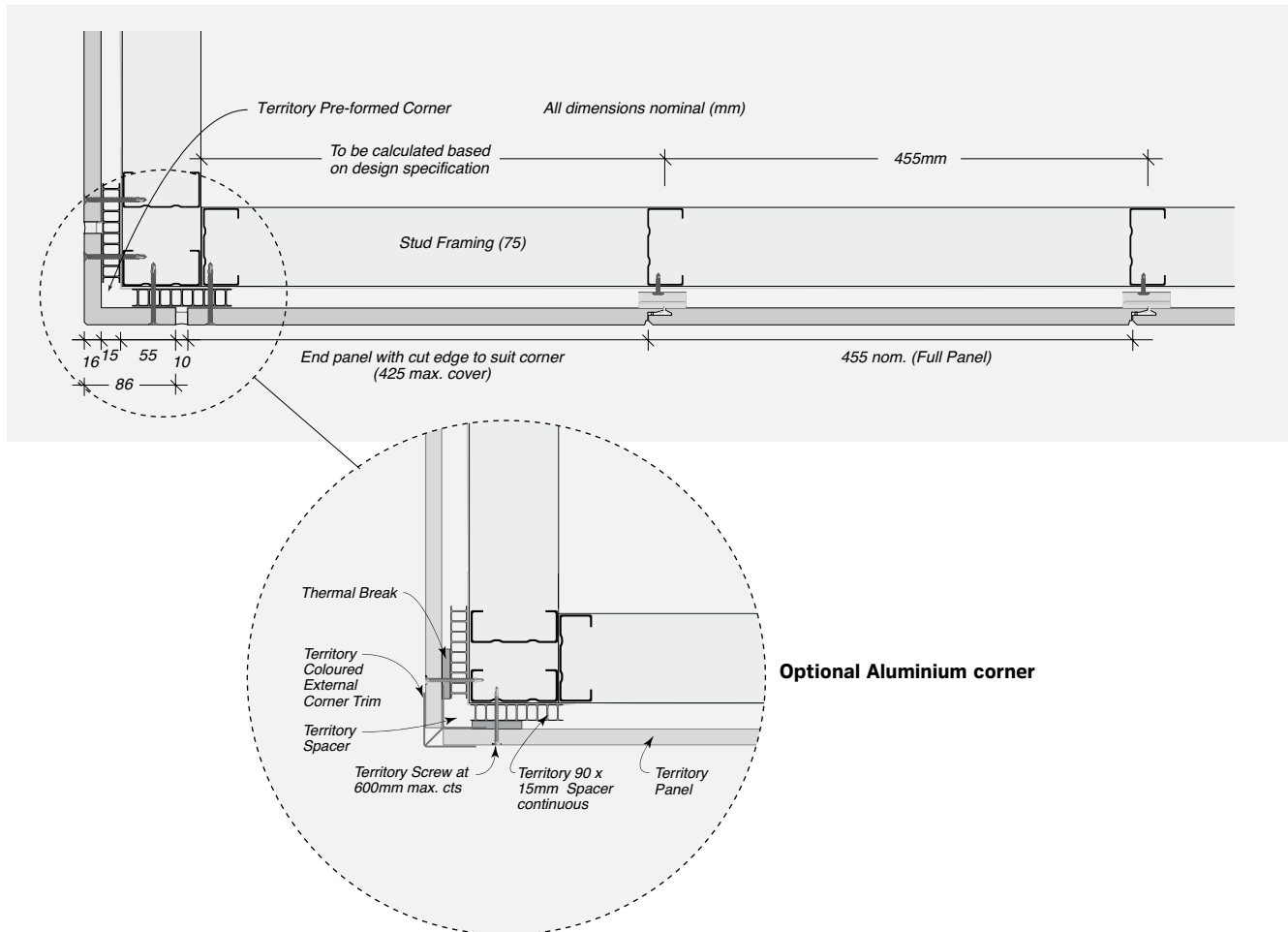

FIGURE 7.09 Typical Framing Set-Out with 75mm Steel Framing and Territory Pre-formed Corners – Plan View



INSTALLATION



FIGURE 7.10 Typical Territory System Cross Section for Steel Framing – Elevation

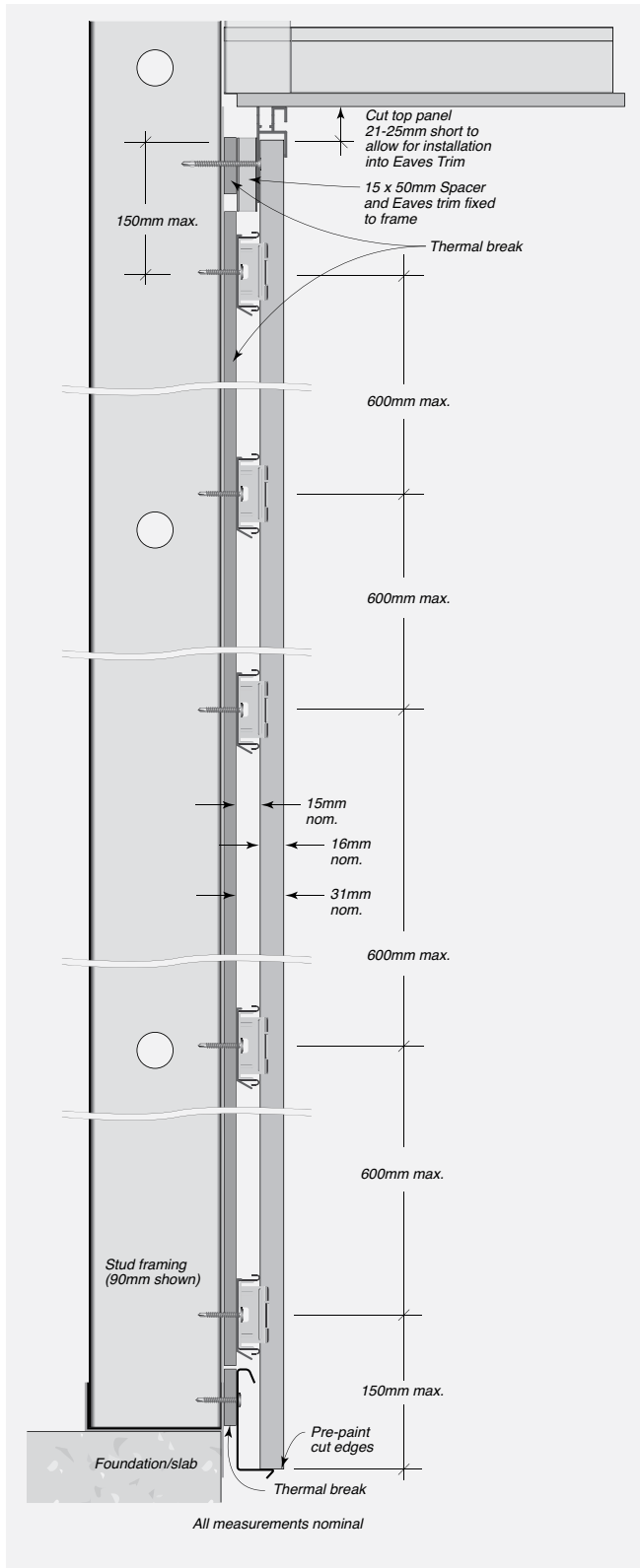
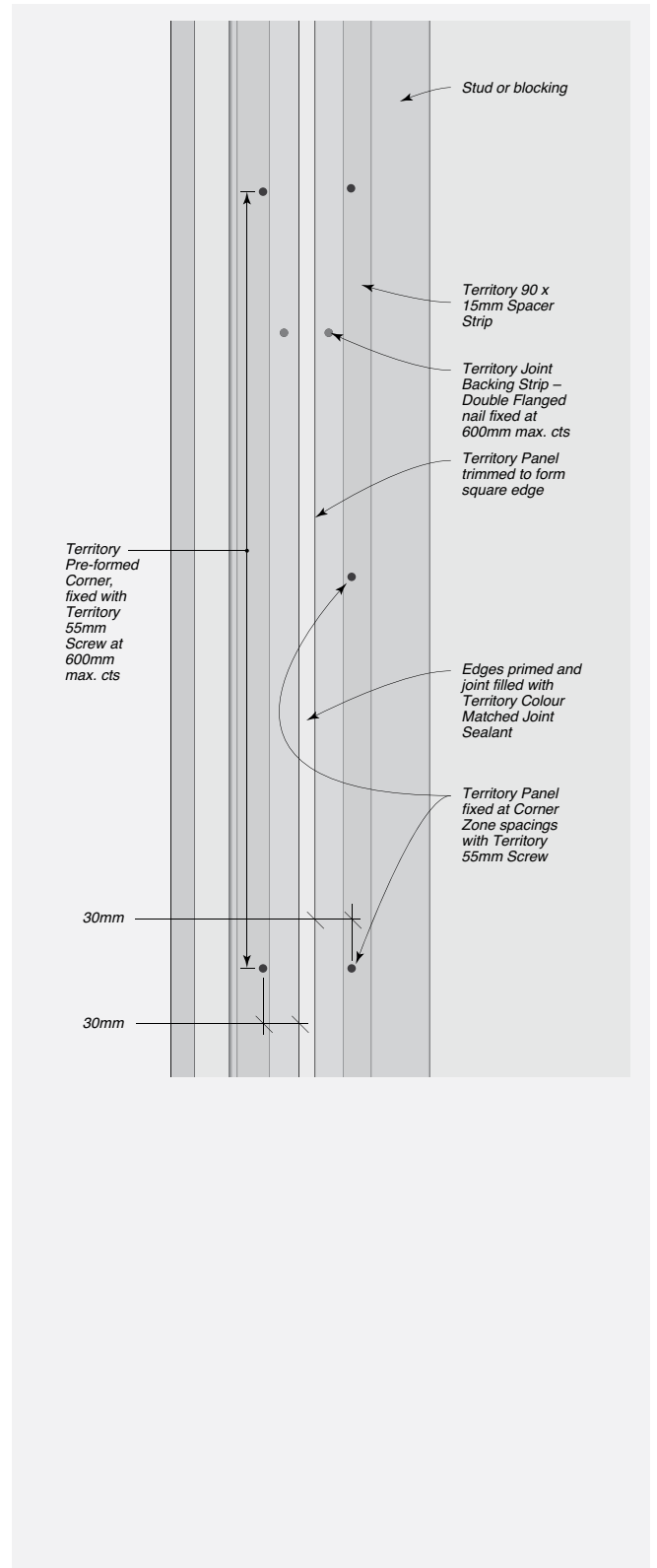

FIGURE 7.11 Typical Territory System Cross Sectional Detail for Steel Framing where Face Fixing is required – Elevation



07

INSTALLATION

Masonry Framing

FIGURE 7.12 Typical Set-Out with H515 Top Hat Framing and Territory Pre-Formed Corners - Plan View

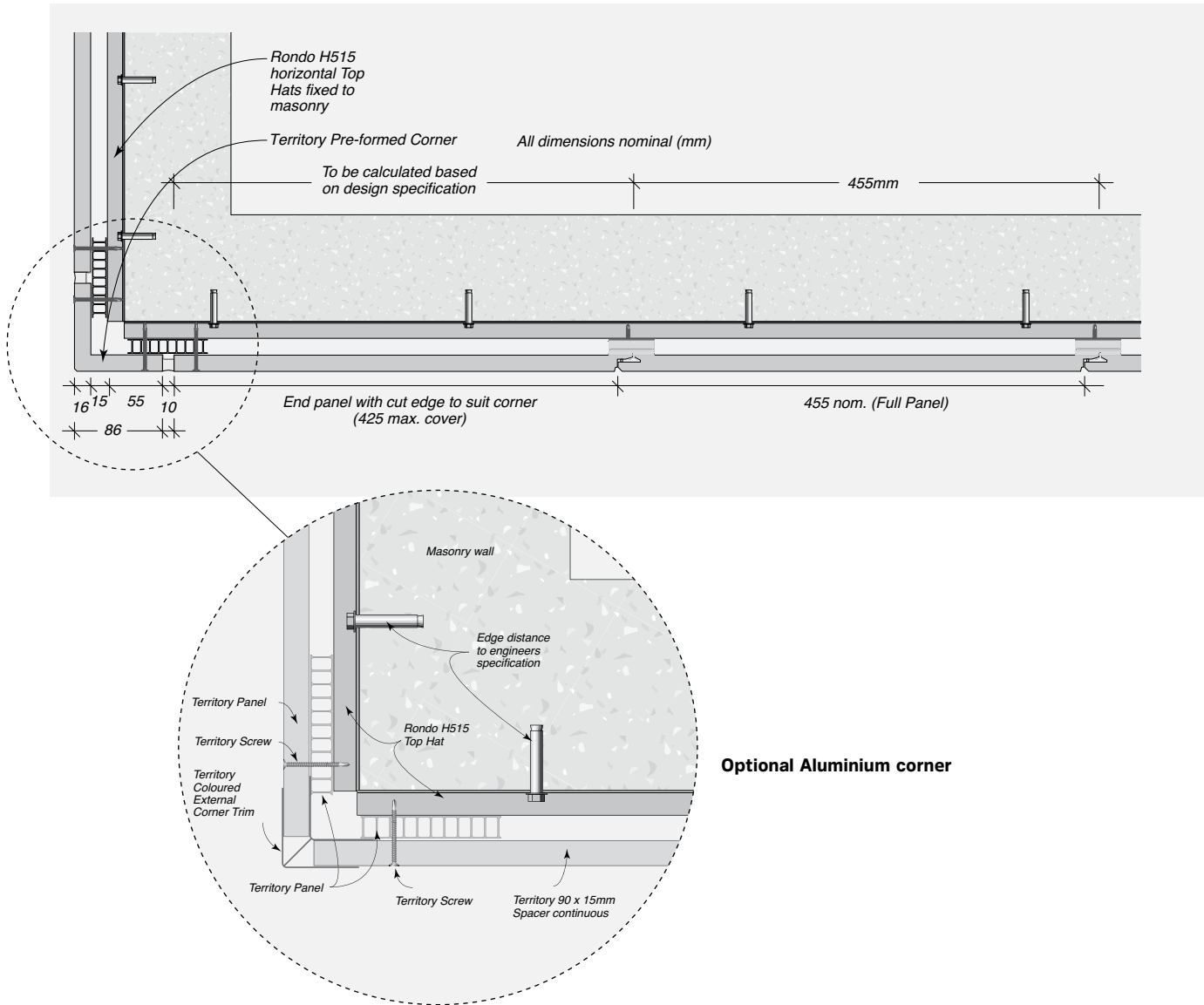

Masonry Framing

FIGURE 7.13 Typical Masonry Territory System Cross Section - Elevation

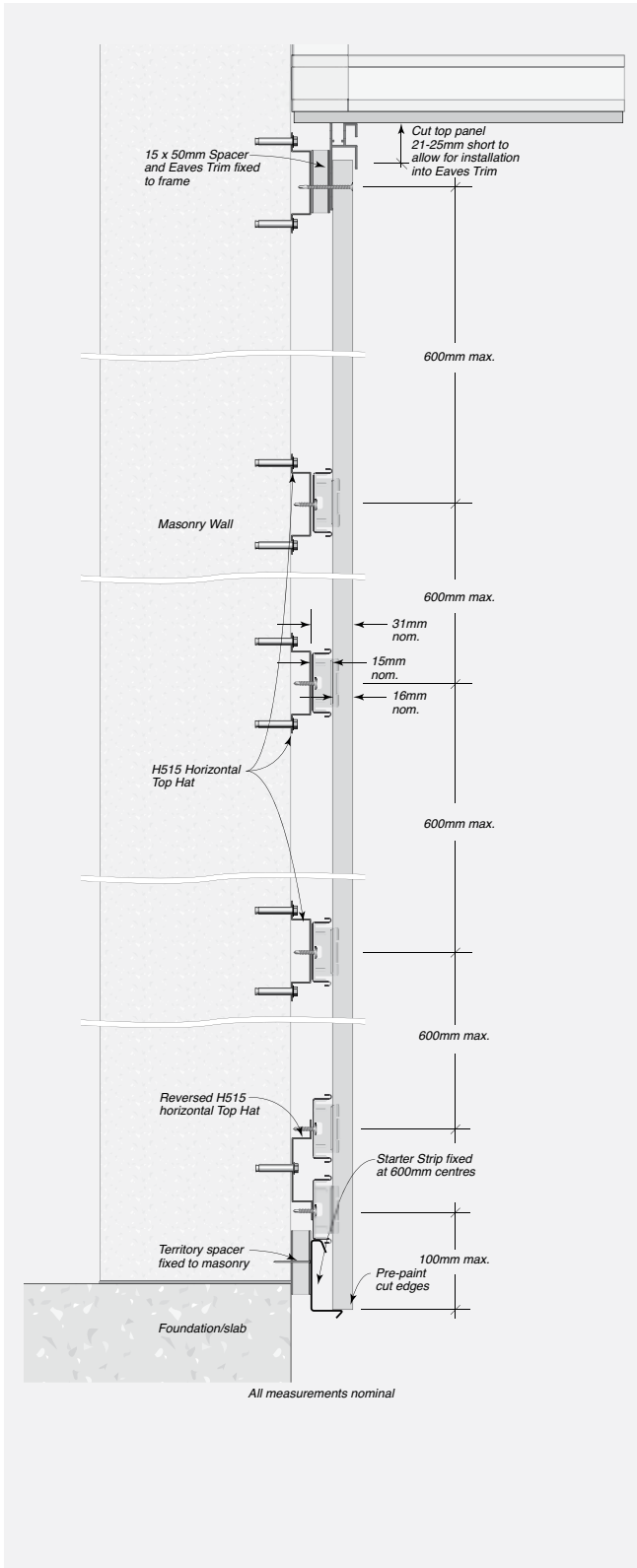
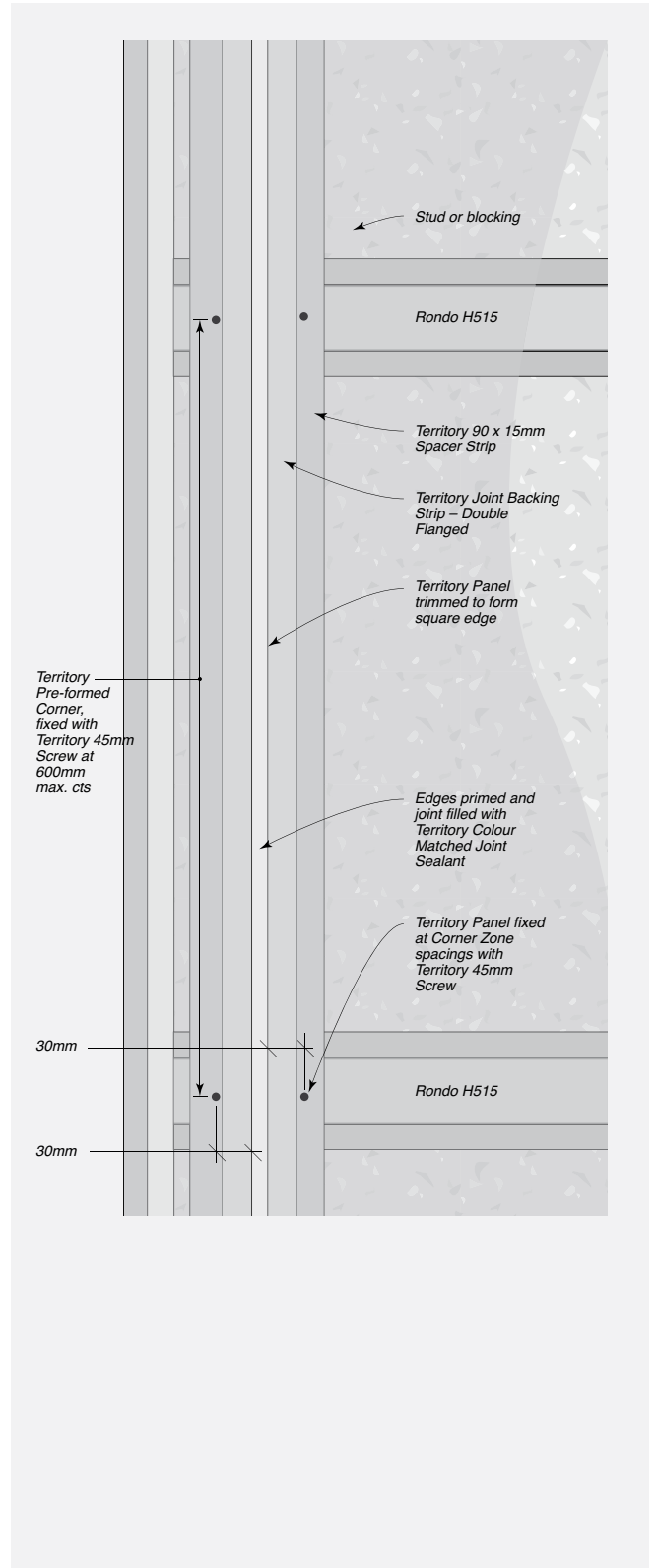

FIGURE 7.14 Typical Face Fastening at Square Edge Joint - Elevation



Installation for Timber and Steel Framing

Refer to 'System Engineering' and 'Construction Drawings and Details' sections for specific fixing information.

Step 1 – Install vertical starter strip to the base of the wall. The first row of panels needs to be positioned to end 50mm below the base of the bottom plate.

Fasten the starter strip level along the whole length of the strip to the base plate/studs. It is critical to ensure the starter strip is fitted level.

Step 2 – Install spacers and joint backing strips.

Install vertical spacers and joint backing strips at all vertical joint locations (this includes where panel meets pre-formed corners and at internal corners).

Step 3 – Prepare soffit. Fix a strip of horizontal spacer (or cut to a minimum length of 200mm at each stud) below the eaves to maintain the 15mm cavity. Allow a small amount of space at the top to allow for ventilation. Fix the eaves corner piece. Slide the eaves trim into the eaves corner piece. Install the eaves trim hard against the eaves or soffit and fix through the spacer onto each stud.

In the case of a backing strip being located on a stud, notch the back of the eaves trim so as to fit over the backing strip.

Step 4 – Install corners.

A. If installing prefinished corners, face fixing is required. The prefinished corner will need to be cut 5-10mm shorter than the height of the eaves trim to allow lifting and positioning onto starter strip. Predrill nail holes through the prefinished corner. Fasteners should be located 20-35mm from panel edges for timber frames or 30-40mm for steel frames. Slide the corner piece down the corner and over the starter strip and fix. It is important to ensure that corner piece is square on both sides. If the corner is not square, pack out.

B. If installing aluminium corners, cut to length remembering to deduct the height measurement of the eaves trim. Notch out to extend over the starter strip. Allow a small amount of space at the top to allow for ventilation. Fix the eaves corner piece. Then, ensuring the aluminium corner trim is level, nail or screw it through the spacer to the frame. The wall panel should fit into the corner trim channel and slide down onto starter strip.

Step 5 – Install wall panels. When cutting panels it is important that any cut edges are sealed with Cemintel NZ's recommended edge sealant to protect against moisture entering the panels. Panels will need to be cut 5-10mm shorter than the height of the eaves trim to allow lifting and positioning onto the starter strip. Place the first wall panel over the starter bar and slide into place. Face fixing is required at corners. Position vertical panel clip firmly over tongue and groove edge of panels at every stud, tap into place and screw to stud. Pack out the clips if necessary to ensure a uniform fixing plane. We recommend consulting a local building surveyor regarding appropriate materials for packing. Continue to install panels, positioning onto starter strip, sliding onto secured clip and repeat. Where face fixing may be required, a strip of Spacer (cut to a minimum length of 200mm) should be positioned between the panel and the frame, thus maintaining the 15mm cavity.

Step 6 - Seal all expansion joints. Apply masking tape to each side of the vertical joints and at the base. Paint the edges of the panels with the primer. This helps the sealant adhere to the panels. Wait at least 30 minutes but no more than 6 hours to apply the sealant. Smooth off the finish removing excess sealant. Carefully remove masking tape in accordance with manufacturer's instructions.

CARE NEEDS TO BE TAKEN NOT TO GET SEALANT ON PANELS as this can result in marks and stains.

Install sealant to gaps at penetrations.

Step 7 - Touch up any exposed fasteners. Wipe panels down with a damp cloth and touch up any exposed nail or screw heads with matching touch up paint.

Step-by-step Installation Procedure

(Refer to specification tables and detail illustrations for specific fixing information)

1 For timber framing, install stud framing with dwangs/noggings behind all clip fixing locations. Refer to Table V01. For steel framing, install stud framing at 455mm centres or at all clip fixing locations. Refer to Table V02. 2 Install building wrap to outside of framing. 3 Install Starter Strip and screw fix to bottom plate at 250mm max. centres with Screws. 4 Install continuous 15 x 90mm Spacer vertically behind expressed joints. 5 Install Joint Backing Strip accurately for the full height of expressed joints.

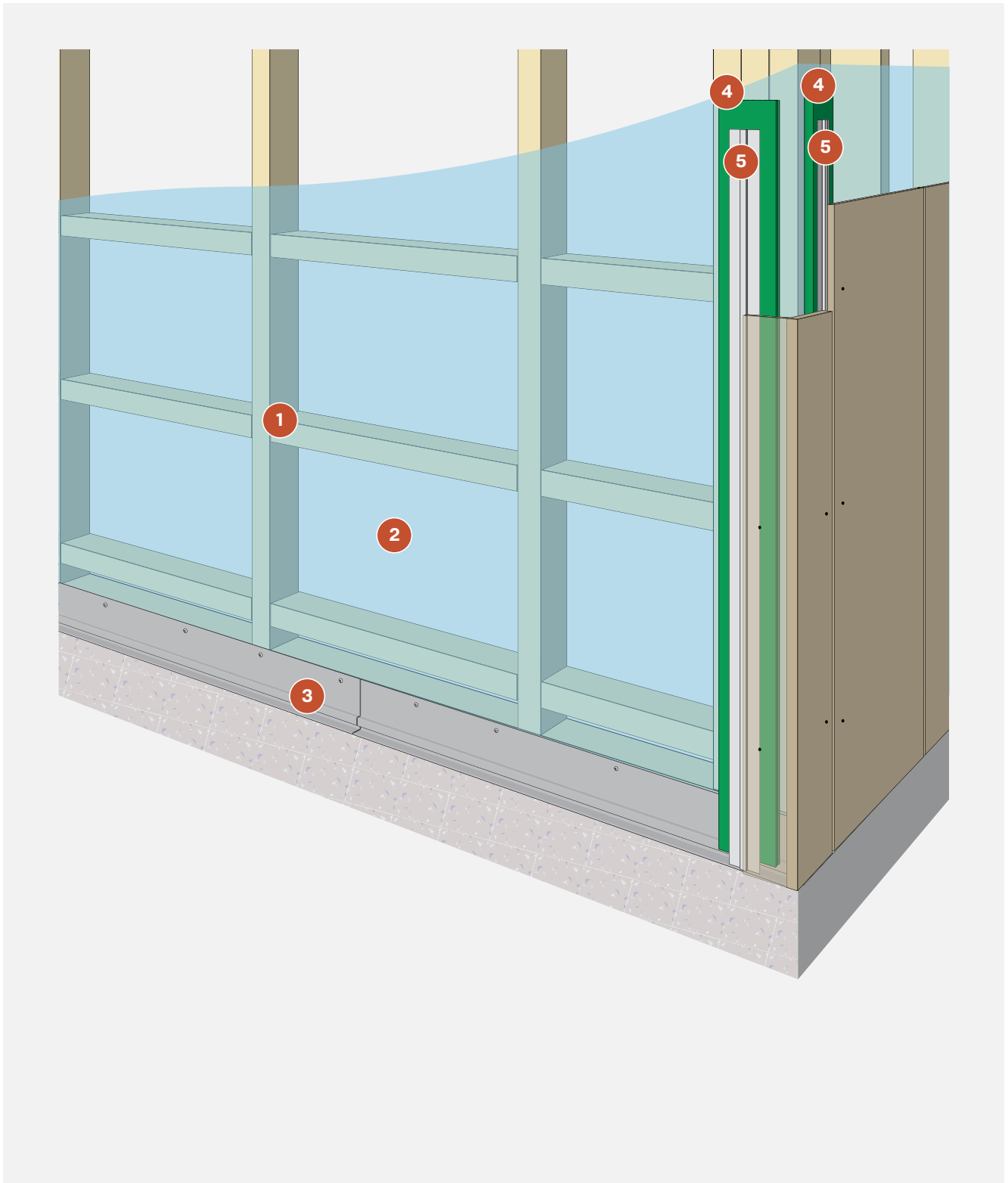

INSTALLATION

07

6 Install 15 x 50mm Horizontal Spacer at the head of the wall. (Refer to head and alternative soffit details.) 7 Install Eaves Trim hard against eaves sheet and fix through spacer with Nails. Trims may be joined where required with Eaves Trim Joiners. Notch the back of the eaves trim to allow for the Joint Backing Strip. (Note: Install Internal Corner Eaves Trims first, and work towards External Corner Trims. Eaves Trims may need to be in-place on both wall faces prior to fitting of pre-formed corner). 8 Install Preformed Corner and fix both faces to framing at vertical spacings specified for clips and at 20-30mm from edges with 75mm nails or 30-40mm from the edges with 55mm screws for steel frame. Pre-drill holes through panel for nails. 9 Trim panel width to project specification and form a square edge. Tilt Panel out at the bottom, insert top into Eaves Trim, lift panel up and locate bottom of panel onto Starter Strip. 10 Tap panel firmly into position against Joint Backing Strip. 11 Fix cut edge of panel at vertical spacings specified for clips and 20-30mm from square edge with 75mm nails for timber frame or 55mm screw for steel framing. Pre-drill holes through panel for nails. 12 Install panel clips and panel clip flashings to the tongue and groove edge on framing at spacings in accordance with Table V01 for timber framing or Table V02 for steel framing. Tap clip firmly into place and fix with one screw.

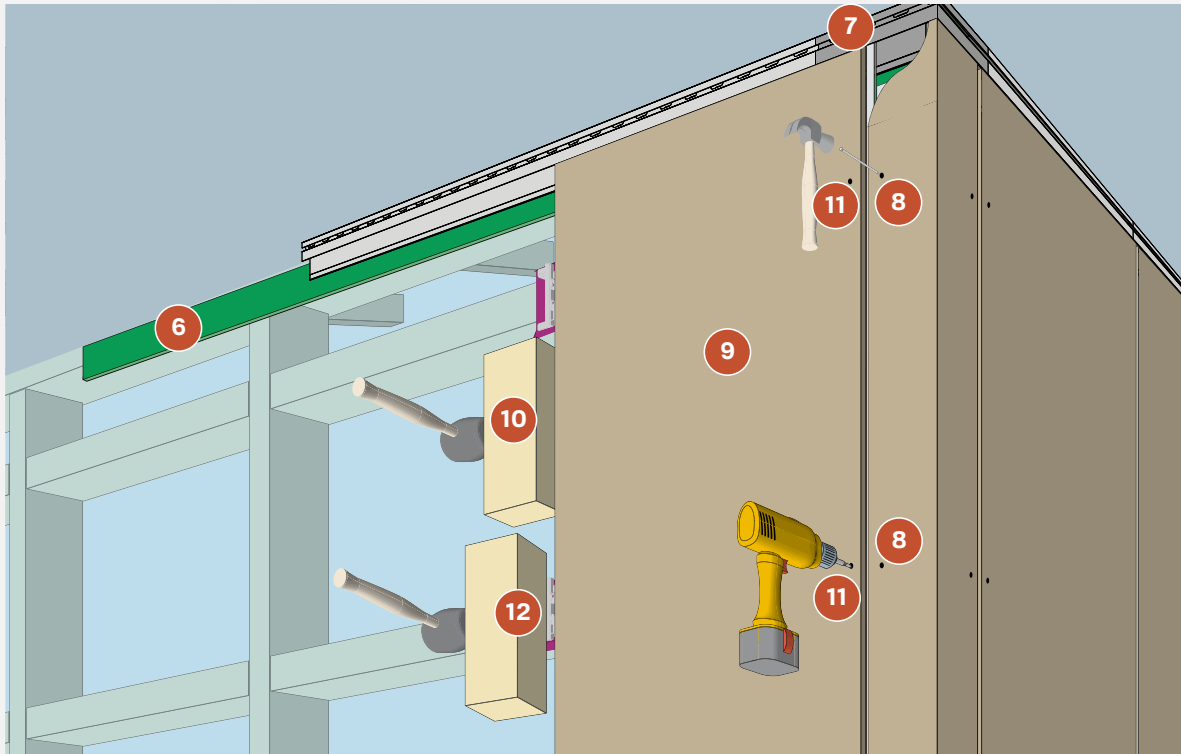

13 Lift the next panel into position, placing the head into the soffit trim and base onto the starter strip. 14 Slide the panel into the existing clips. Firmly tap panel into position. 15 Fit and fix panel clips and panel clip flashings to the framing as for the previous clips. Repeat steps 13, 14 and 15 for additional panels. 16 Mask and prime edges of expressed joint and fill joints with colour matched sealant. Prime and touch-up visible fixing heads.

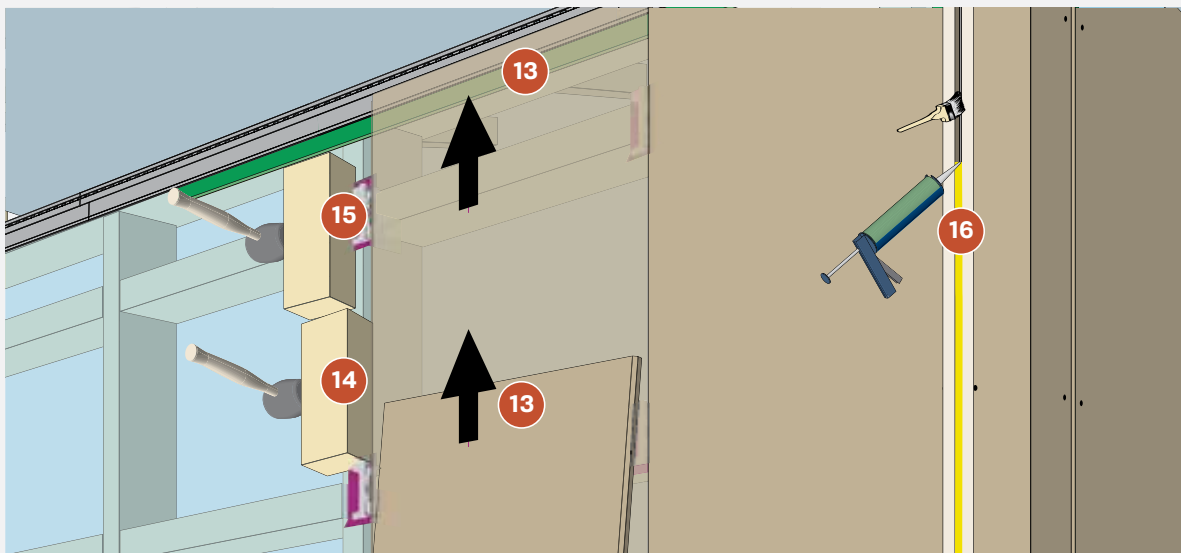

Installation for Masonry

Refer to 'System Engineering' and 'Construction Drawings and Details' sections for specific fixing information.

Note that Masonry structures are potentially more likely to be out of plumb. The Top Hat installation detailed in this Guide only allows for a small variation in the surface plane and industry best practice for frame tolerances of 5mm misalignment over 3000mm should be followed. Careful assessment should be undertaken to determine if this solution is appropriate for the specific situation.

Step 1 – Install H515 Top Hats horizontally at maximum 600mm centres. To account for minimum edge distance of masonry fixings, install Top Hats in reverse at base, head and openings.

Step 2 – Install extended starter strip. Install continuous horizontal spacer directly to the base of the masonry wall. Install the extended starter strip to the base of the wall by fastening into the bottom leg of the reversed H515 Top Hat. Screw x at 600mm centres. Ensure 10-15mm clearance between base flashing and bottom edge of panel. If the wall has external corners, starter strip needs to be extended 30mm beyond the end of the wall to accommodate the cavity (H515 and clips) of the adjacent wall. Note: all extended starter strips are required to be backed by continuous horizontal spacers. Other locations include window heads and horizontal control joints.

Step 3 – Install joint backing strips.

Install joint backing strips at all vertical joint locations.

Step 4 – Prepare soffit. Fix a continuous strip of horizontal spacer across the head of the wall on the H515 Top Hat below the eaves or soffit to maintain the 15mm cavity. Allow a small amount of space at the top to allow for ventilation. Fix the eaves corner piece. Slide the eaves trim into the eaves corner piece. Install the eaves trim hard against the eaves or soffit and fix through the spacer into Top Hat. In the case of a backing strip, notch the back of the eaves trim so as to fit over the backing strip.

Step 5 – Install corners.

A. If installing prefinished corners, face fixing is required. Corner will need to be cut 5-10mm shorter than the height of the eaves trim to allow lifting and positioning onto starter strip. Predrill nail holes through the prefinished corner. Fasteners should be located 30-40mm from edge of prefinished corners. Slide the corner piece down the corner and over the starter strip and fix. It is important to ensure that the corner piece is square on both sides. If the corner is not square, pack out.

B. If installing aluminium corners, cut to length remembering to deduct the height measurement of the eaves trim. Notch out to extend over the starter strip. Allow a small amount of space at the top to allow for ventilation. Fix the eaves corner piece. Then, ensuring the aluminium corner trim is level, screw it through the spacer to the frame.

The wall panel should fit into the corner trim channel and slide down onto starter strip.

Step 6 – Install wall panels. When cutting panels it is important that any cur edges are sealed with Cemintel's edge sealer to protect against moisture entering the panels. Panels will need to be cut 5-10mm shorter than the height of the eaves trim to allow lifting and positioning onto the starter strip. Place the first wall panel over the starter strip and slide into place. Face fixing is required at corners and at eaves. Position vertical panel clip firmly over tongue and groove of edge panel, tap into place and screw to H515 Top Hat with 12mm Territory screw. Pack out the clips if necessary to ensure a uniform fixing plane. We recommend consulting the local builder surveyor regarding the appropriate materials for packing.

Continue to install panels, positioning onto starter strip, sliding onto secured clip and repeat. Where face fixing maybe required, a strip of spacer (cut to a minimum length of 200mm) should be positioned between the panel and the frame, thus maintaining the 15mm cavity.

Step 7 – Seal all expansion joints. Apply masking tape to each side of the vertical joints and at the base. Paint the edges of the panels with the primer. This helps the sealant adhere to the panels. Wait at least 30 minutes but no more than 6 hours to apply the colour matched sealant. Smooth off the finish removing excess sealant. Carefully remove masking tape in accordance with manufacturer's instructions. CARE NEEDS TO BE TAKEN NOT TO GET SEALANT ON PANELS as this can result in marks and stains.

Install sealant to gaps at windows and other penetrations.

Step 8 – Touch up any exposed fasteners. Wipe panels down with a damp cloth and touch up any exposed nail or screw heads with matching touch up paint.



CONSTRUCTION
DRAWINGS + DETAILS



CONSTRUCTION DRAWINGS AND DETAILS

Note: Drawings are interchangeable for timber or steel substrates with the exception of the fasteners.

Drawings Index

SECTION	DESCRIPTION	FIGURE REFERENCE	PAGE NUMBER
Base Details	Base Detail – Concrete Slab Construction	8.01	41
	Second Storey Junction with Masonry, Brick Veneer or Hebel Panels – Cantilevered Framing	8.02	41
	Base Detail – Beam & Joist Construction	8.03	4
	Second Storey Junction with Masonry, Brick Veneer or Hebel Panels – In-line Framing	8.04	41
Soffit Details	Soffit Detail – With Coloured Eaves Trim – Elevation	8.05	42
	Soffit Detail – With Timber Trim – Elevation	8.06	42
	Soffit Detail	8.07	42
	Soffit Detail – With Soffit Trim – Elevation	8.08	42
Corner Details	External Corner Detail – With Preformed Corner – Plan View	8.09	43
	External Corner Detail – With Coloured External Corner Trim – Plan View	8.10	43
	Internal Corner Detail – With Backing Strip and Colour Matched Sealant – Plan View	8.11	43
	Obtuse Angle Corner Detail – With Metal Flashing and Colour Matched Sealant – Plan View	8.12	43
Window Details	Typical Window Head, Sill and Jamb Detail	8.13	44
	Typical Window Head/Jamb Detail – Front Elevation	8.14	44
Garage Door Details	Typical Garage Door Jamb Detail	8.15	45
	Typical Garage Door Head Detail	8.16	45
	Typical Penetration	8.17	45
	No Soffit wall detail	8.18	45
Meter Box Details	Typical Power/Meter Box – Recessed into Framing – Elevation	8.19	46

CONSTRUCTION DRAWINGS AND DETAILS



Note: Drawings are interchangeable for timber or steel substrates with the exception of the fasteners.

SECTION	DESCRIPTION	FIGURE REFERENCE	PAGE NUMBER	
Junction Details	Horizontal Control Joint – Second Storey Junction – Open Cavity	8.20	47	
	Horizontal Control Joint – Between Panels	8.21	47	
	Horizontal Control Joint – Second Storey Junction – Closed Cavity	8.22	47	
	Junction with External Pitched Soffit	8.23	47	
	Junction with External Roofing	8.24	48	
	Junction of with External Roofing	8.25	48	
	Two Sided Parapet Wall Junction – Plan View	8.26	48	
	Two Sided Parapet – Elevation A	8.27	48	
	Two Sided Parapet Wall Junction – Stage 1 Procedure	8.28	49	
	Two Sided Parapet Wall Junction – Stage 2 Procedure	8.29	49	
	Two Sided Parapet Wall Junction – Stage 3 Procedure	8.30	49	
	External Corner Junction – Panel to Brick Veneer – Plan View	8.31	50	
	Typical Abutment – Panel to Brick Veneer – Plan View	8.32	50	
	Internal Corner Junction – Panel to Brick Veneer – Plan View	8.33	50	
	Typical Internal Corner Junction Panel to Masonry Wall – Plan View	8.34	51	
	Typical Internal Corner Junction Panel to Weatherboard – Plan View	8.35	51	
	Typical Abutment – Panel to Weatherboard – Plan View	8.36	51	
	Typical External Corner Junction Panel to Weatherboard – Plan View	8.37	51	
	Typical Abutment with In-line or Out-set Masonry Wall – Plan View	8.38	52	
	Typical Abutment with In-set Masonry Wall – Plan View	8.39	52	
	Typical Abutment with Direct Fixed Cladding System – Plan View	8.40	52	
	Base Detail – Concrete Slab Construction – Plan View	8.41	53	
	Soffit Detail – With Coloured Eaves Trim – Elevation	8.42	53	
	Horizontal Control Joint – Second Storey Junction – Open Cavity	8.43	53	
	External Corner Detail – With Preformed Corner – Plan View	8.44	54	
	External Corner Detail – With Coloured External Corner Trim – Plan View	8.45	54	
	Internal Corner Detail – With Backing Strip and Colour Matched Sealant – Plan View	8.46	54	
	Parapet Detail – Elevation	8.47	54	
	Masonry Window Details	Typical Domestic Window Head, Sill and Jamb Detail	8.48	55
		Typical Commercial Window Head, Sill and Jamb Detail	8.49	56
		Typical Power/Meter Box – Recessed into Framing – Elevation	8.50	57



CONSTRUCTION DRAWINGS AND DETAILS

Note: Drawings are interchangeable for timber or steel substrates with the exception of the fasteners.

Base Details

FIGURE 8.01 Base Detail - Concrete Slab Construction

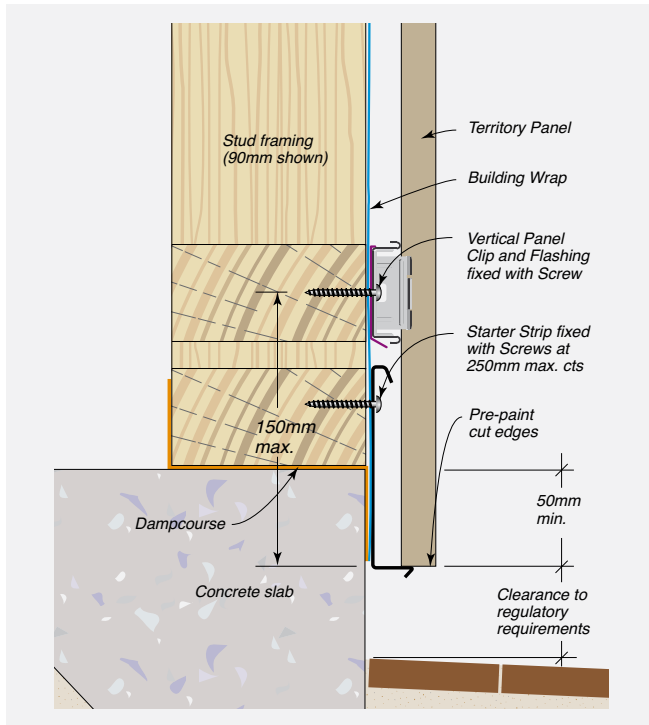

FIGURE 8.03 Base Detail - Beam & Joist Construction

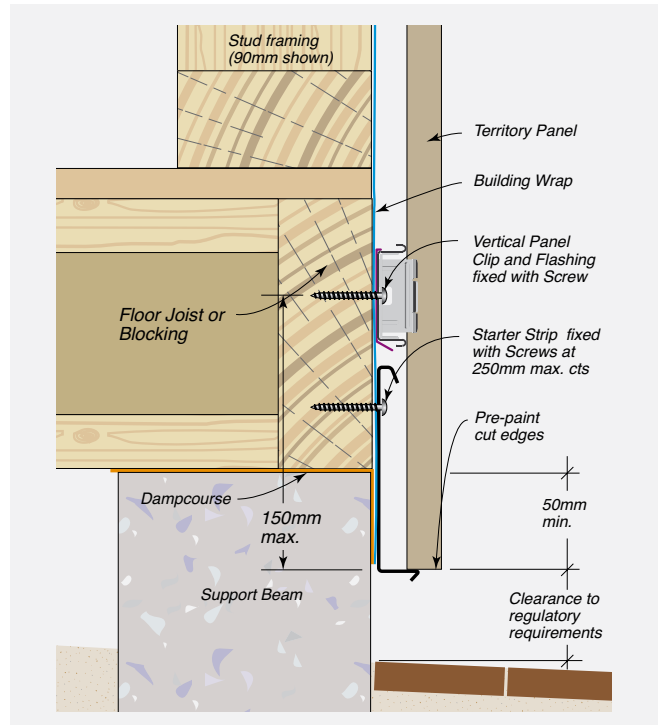

FIGURE 8.02 Second Storey Junction with Masonry, Brick Veneer or Hebel Panels - Cantilevered Framing

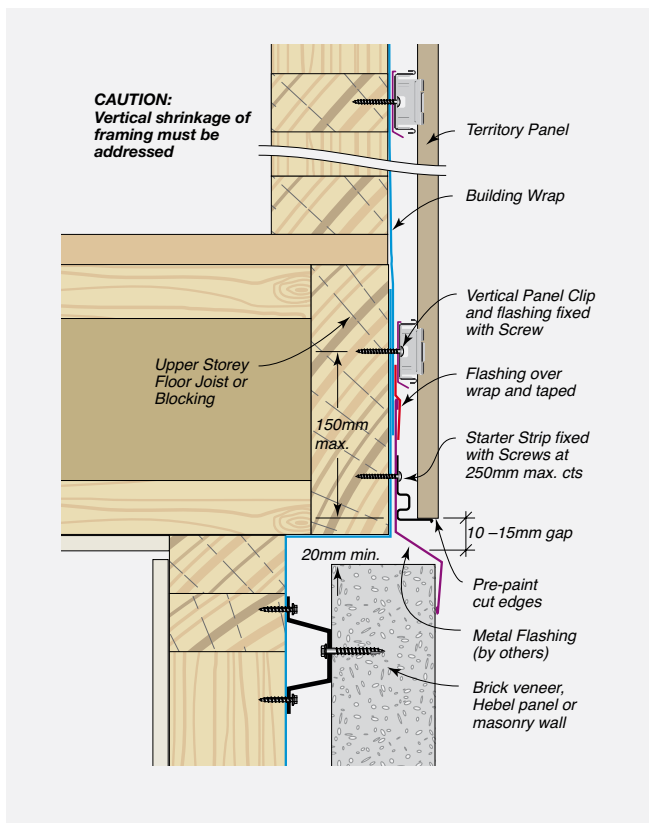
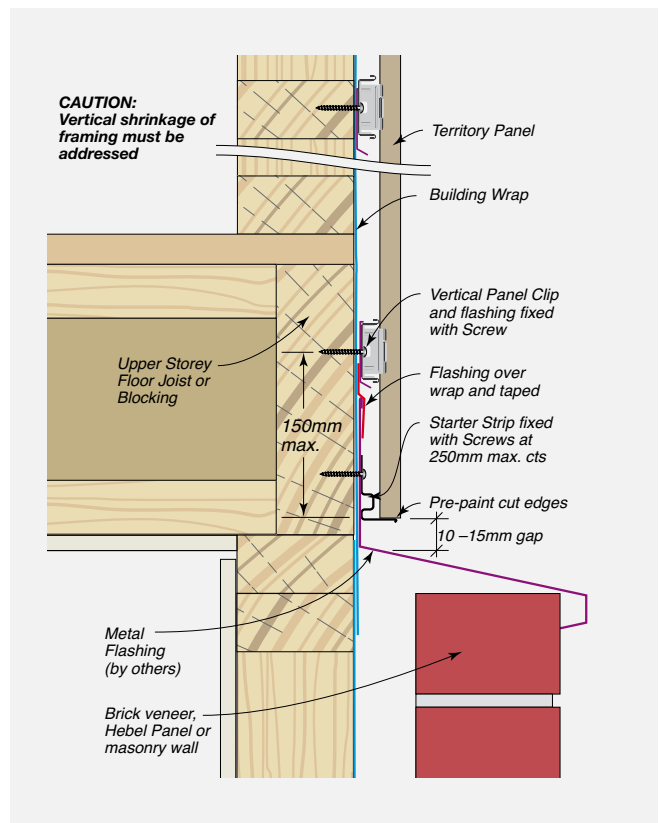

FIGURE 8.04 Second Storey Junction with Masonry, Brick Veneer or Hebel Panels - In-line Framing



CONSTRUCTION DRAWINGS AND DETAILS



Note: Drawings are interchangeable for timber or steel substrates with the exception of the fasteners.

Soffit Details

At eaves line the Territory Panel system must be provided with cavity ventilation. Refer to the following detail options.

FIGURE 8.05 Soffit Detail – With Coloured Eaves Trim – Elevation

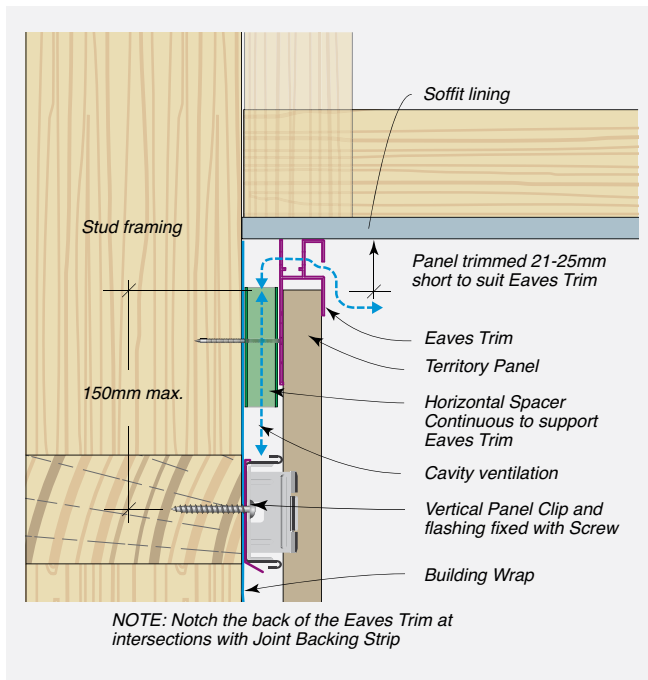

FIGURE 8.06 Soffit Detail – With Timber Trim – Elevation

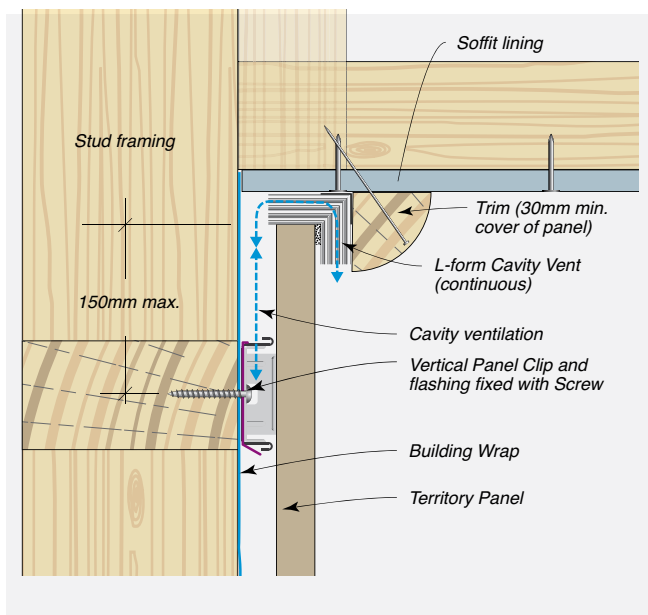

FIGURE 8.07 Soffit Detail

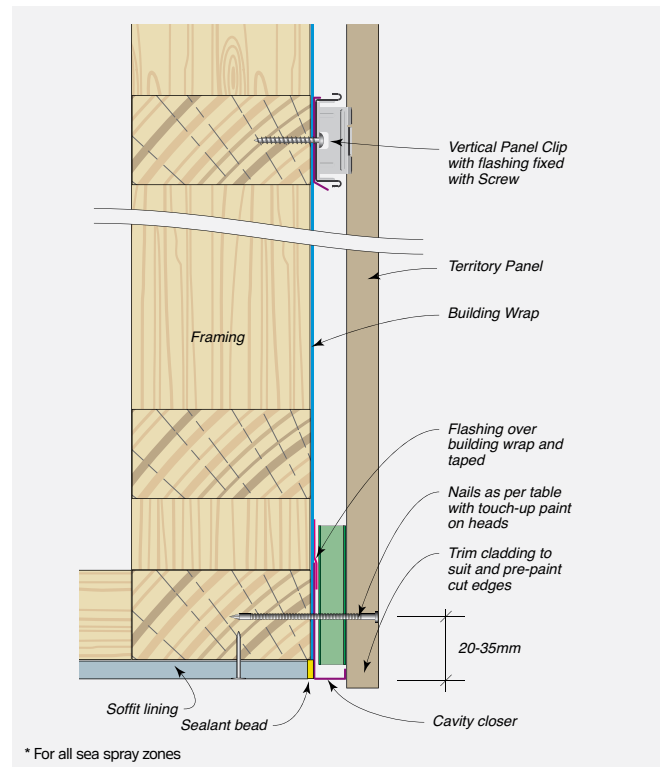
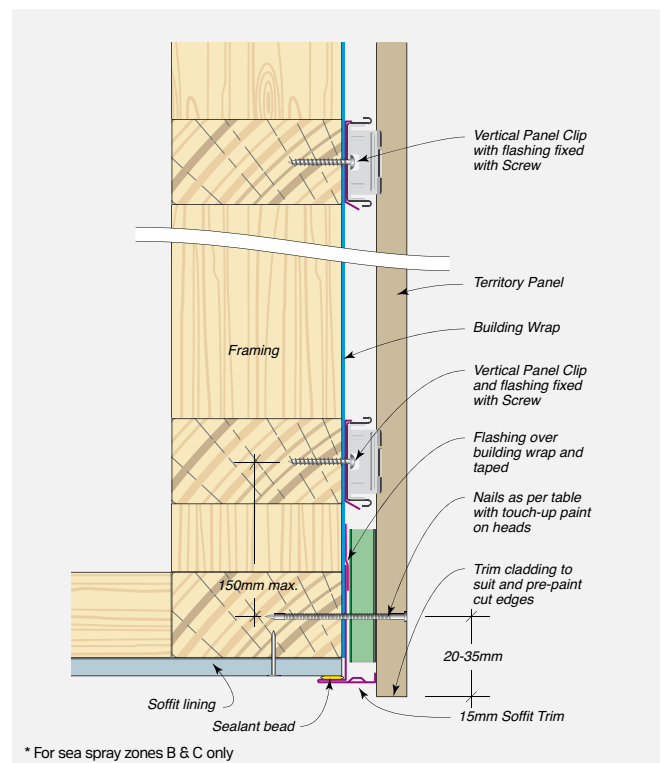

FIGURE 8.08 Soffit Detail – With Soffit Trim – Elevation





CONSTRUCTION DRAWINGS AND DETAILS

Note: Drawings are interchangeable for timber or steel substrates with the exception of the fasteners.

Corner Details

Additional studs/framing may be required at corners, abutments and junctions to allow for fixing of Panel Clips, Panels and other components.

FIGURE 8.09 External Corner Detail - With Preformed Corner - Plan View

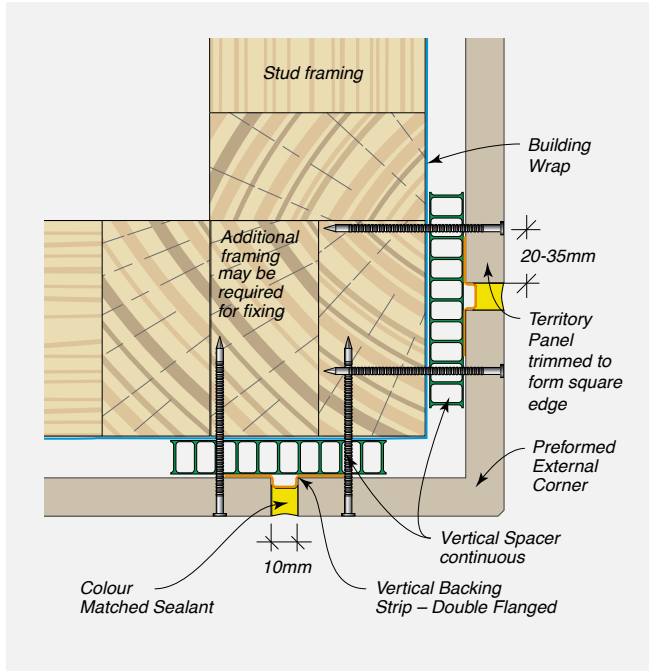

FIGURE 8.10 External Corner Detail - With Coloured External Corner Trim - Plan View

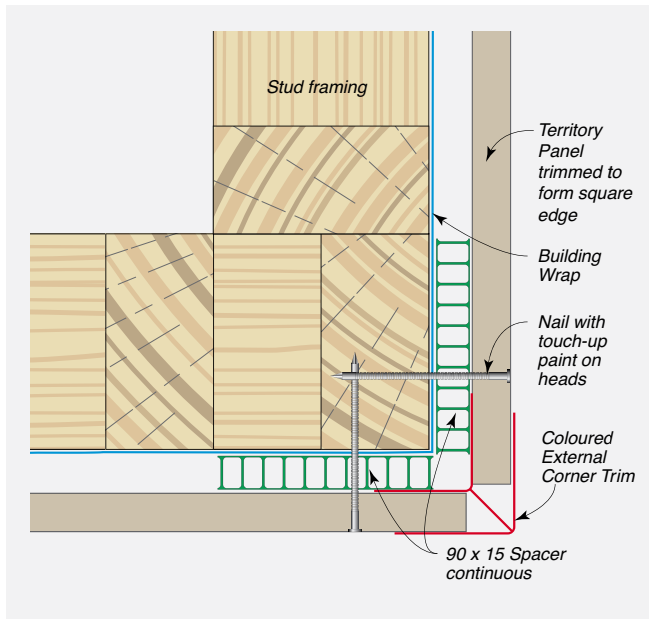

FIGURE 8.11 Internal Corner Detail - With Backing Strip and Colour Matched Sealant - Plan View

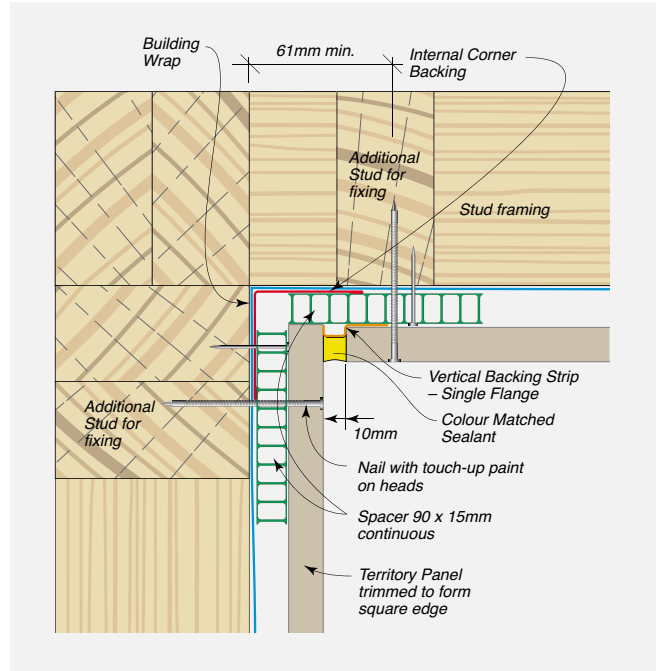
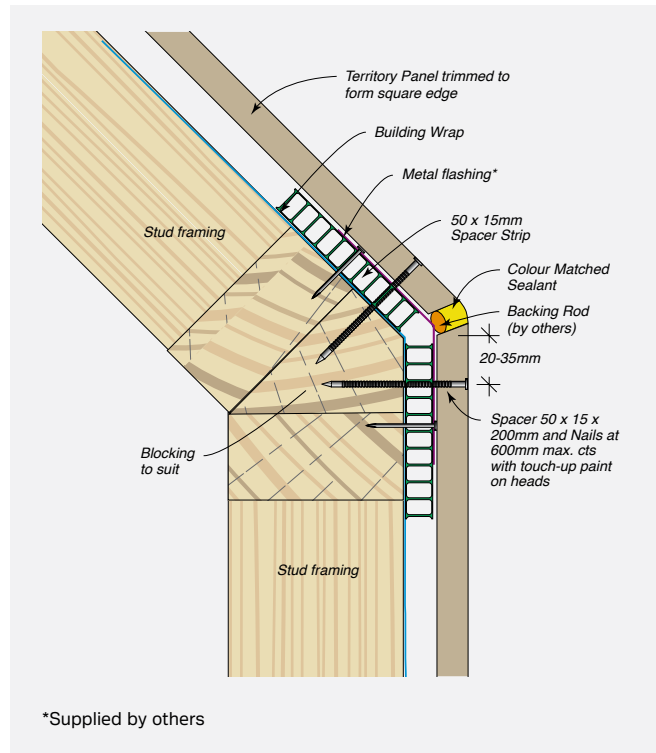

FIGURE 8.12 Obtuse Angle Corner Detail - With Metal Flashing and Colour Matched Sealant - Plan View



CONSTRUCTION DRAWINGS AND DETAILS



Note: Drawings are interchangeable for timber or steel substrates with the exception of the fasteners.

Window Details

FIGURE 8.13 Typical Window Head, Sill and Jamb Detail

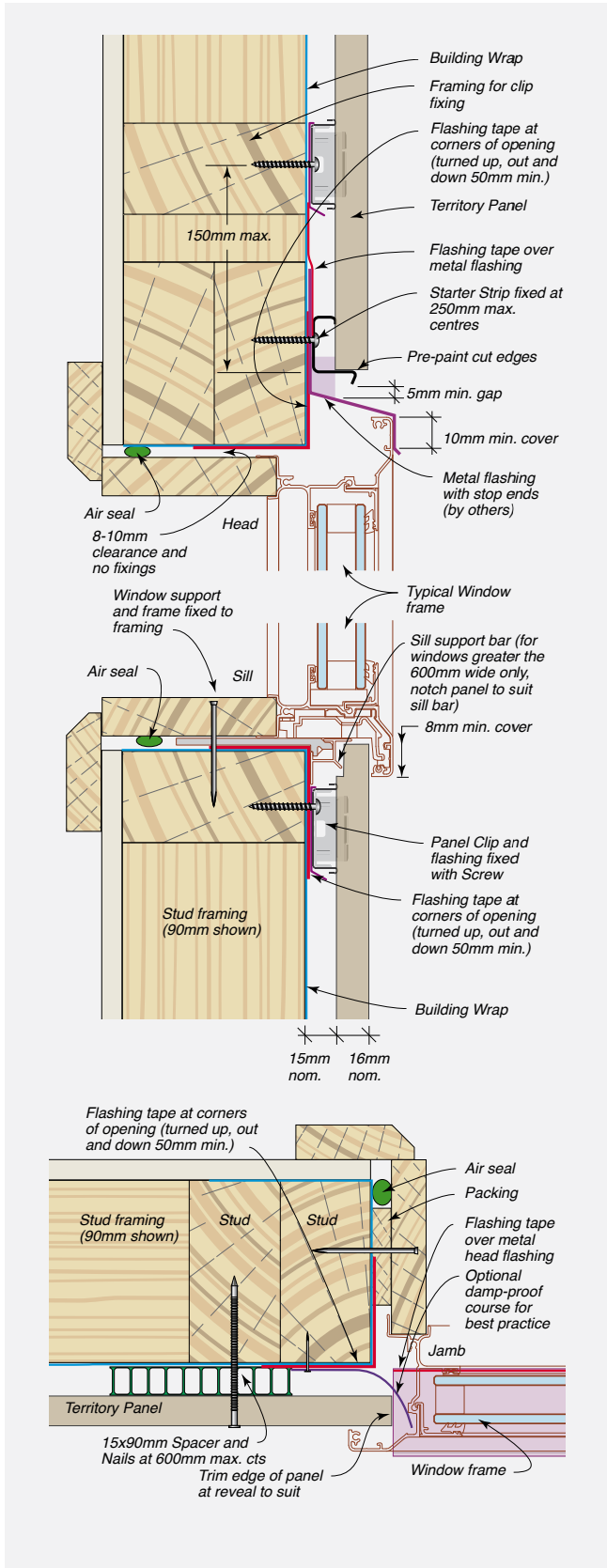
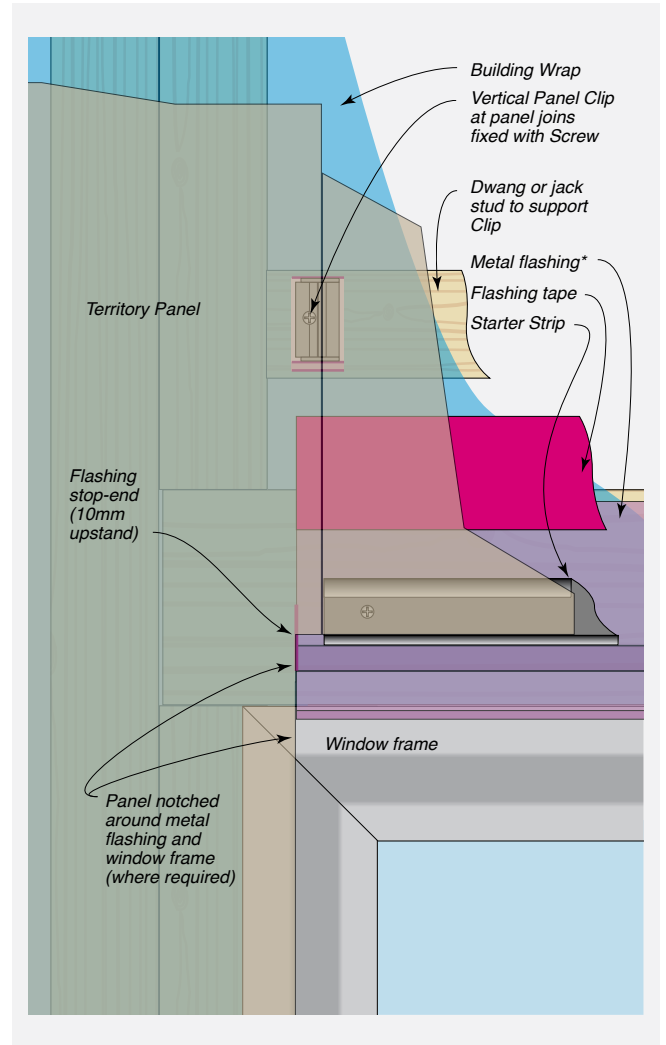

FIGURE 8.14 Typical Window Head/Jamb Detail –Front Elevation





CONSTRUCTION DRAWINGS AND DETAILS

Note: Drawings are interchangeable for timber or steel substrates with the exception of the fasteners.

Garage Door Details

FIGURE 8.15 Typical Garage Door Jamb Detail

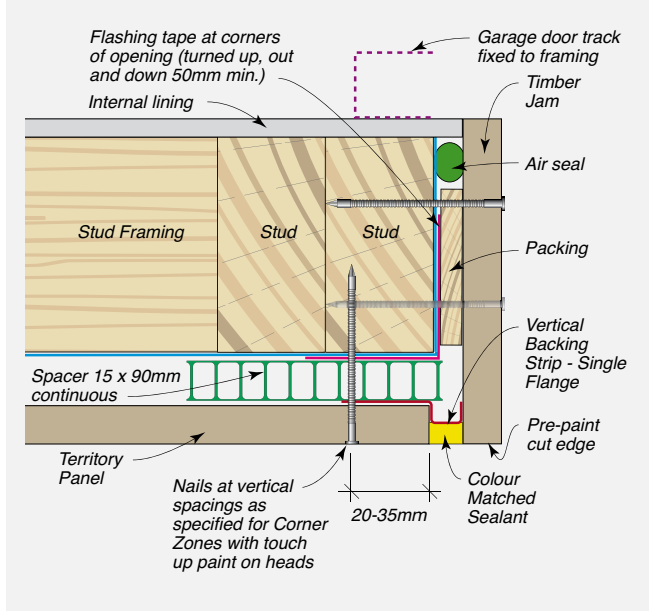

FIGURE 8.16 Typical Garage Door Head Detail

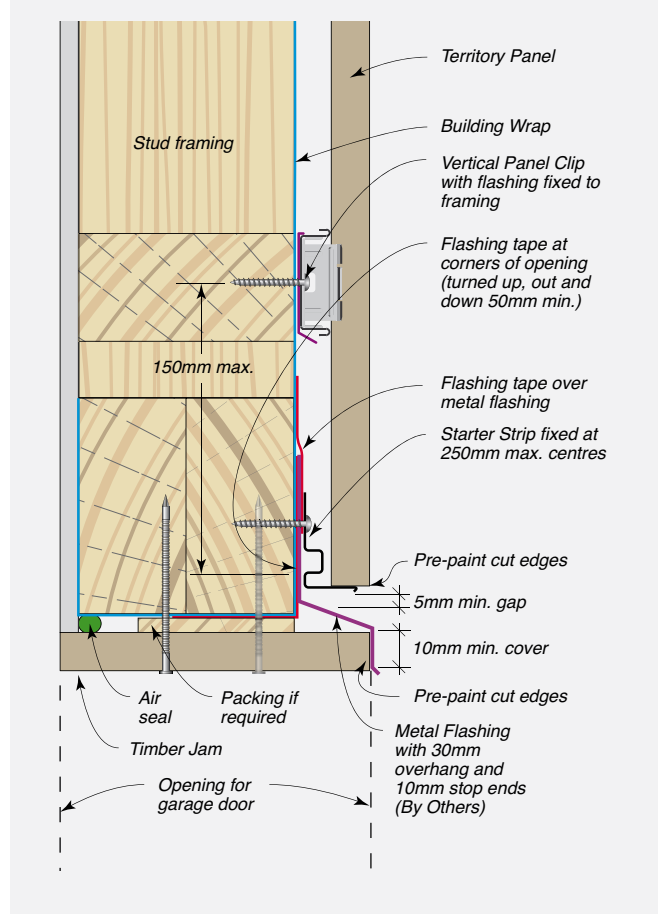

FIGURE 8.17 Typical Penetration

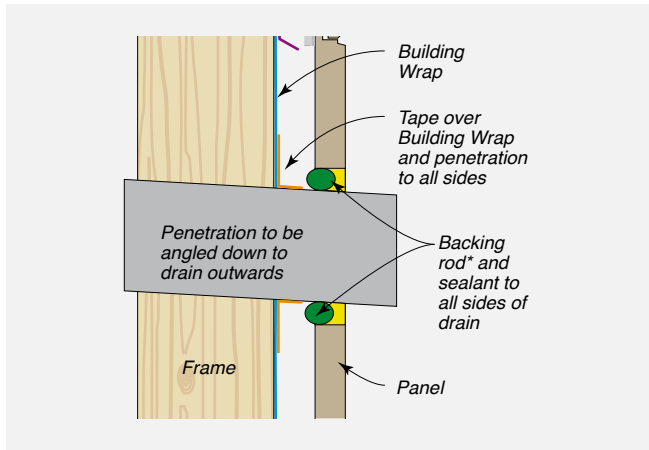
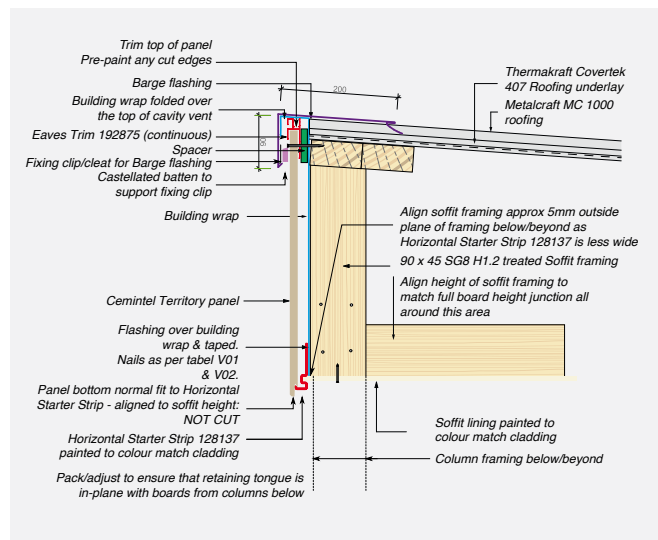

FIGURE 8.24 No Soffit wall detail



CONSTRUCTION DRAWINGS AND DETAILS



Note: Drawings are interchangeable for timber or steel substrates with the exception of the fasteners.

Meter Box Details

FIGURE 8.19 Typical Power/Meter Box – Recessed into Framing – Elevation

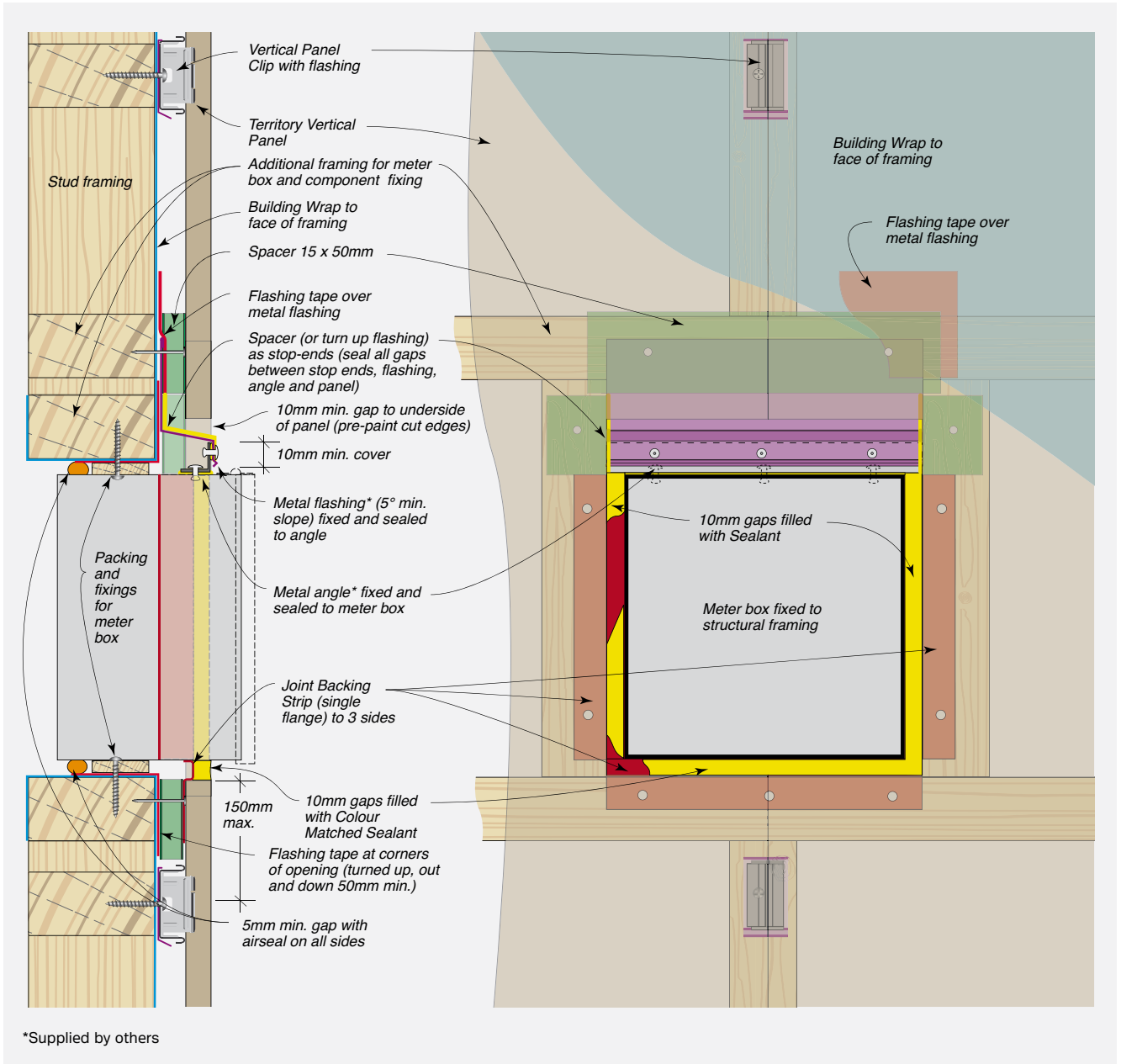



CONSTRUCTION DRAWINGS AND DETAILS

Note: Drawings are interchangeable for timber or steel substrates with the exception of the fasteners.

Junction Details

FIGURE 8.20 Horizontal Control Joint – Second Storey Junction – Open Cavity

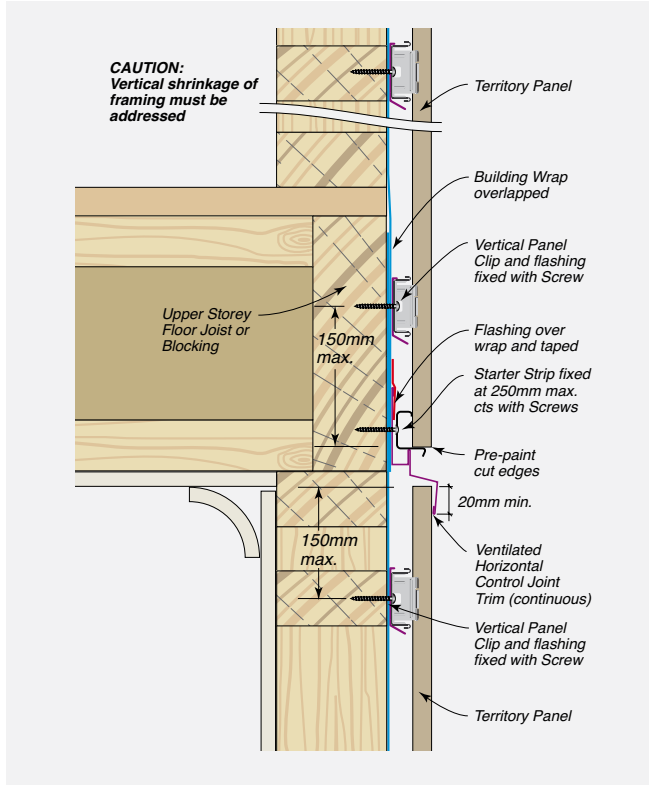

FIGURE 8.22 Horizontal Control Joint – Second Storey Junction – Closed Cavity

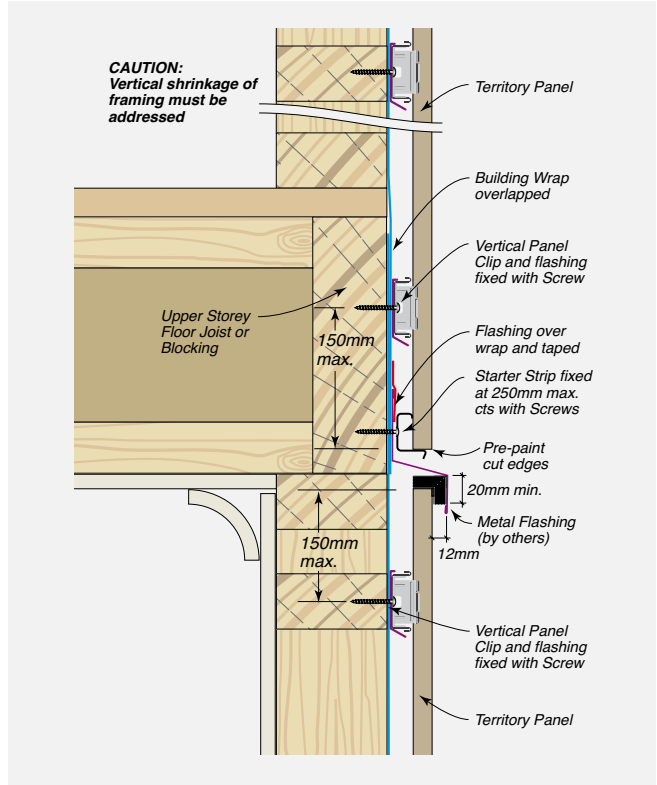

FIGURE 8.21 Horizontal Control Joint – Between Panels

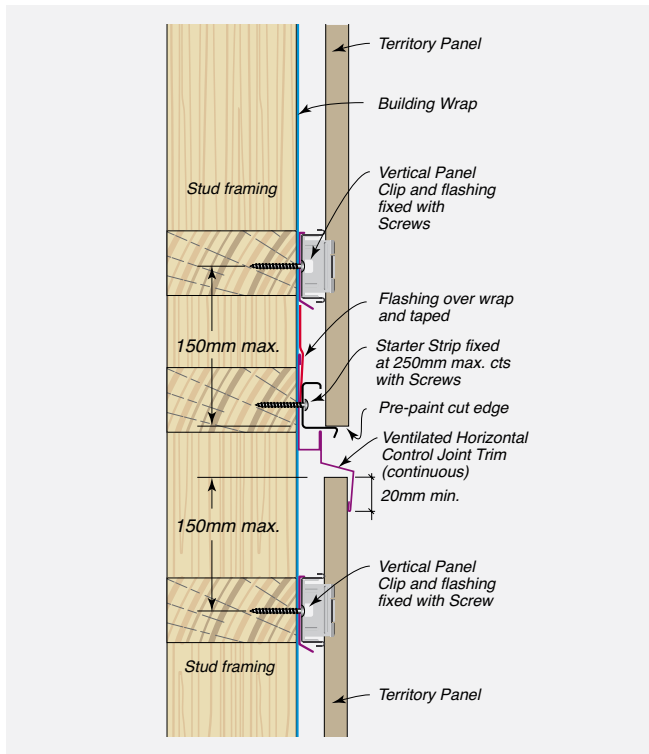
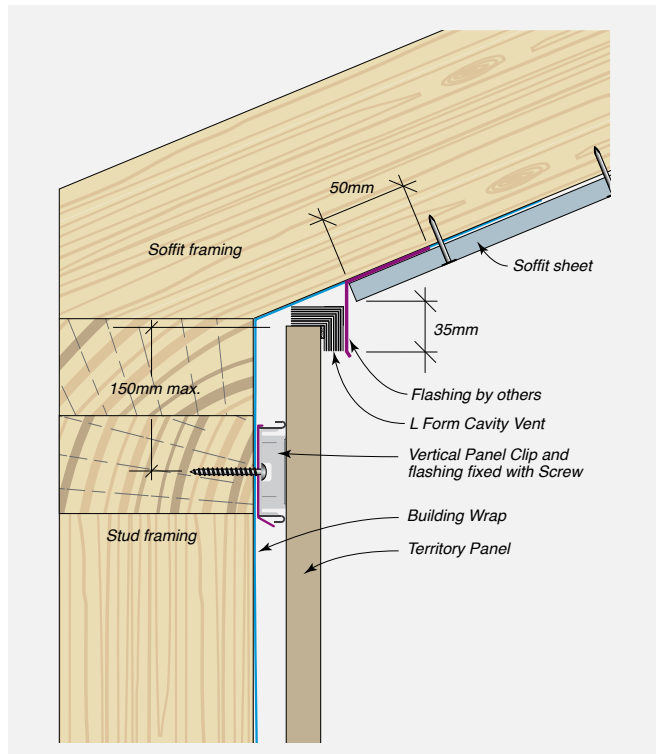

FIGURE 8.23 Junction with External Pitched Soffit



CONSTRUCTION DRAWINGS AND DETAILS



Note: Drawings are interchangeable for timber or steel substrates with the exception of the fasteners.

FIGURE 8.24 Junction with External Roofing

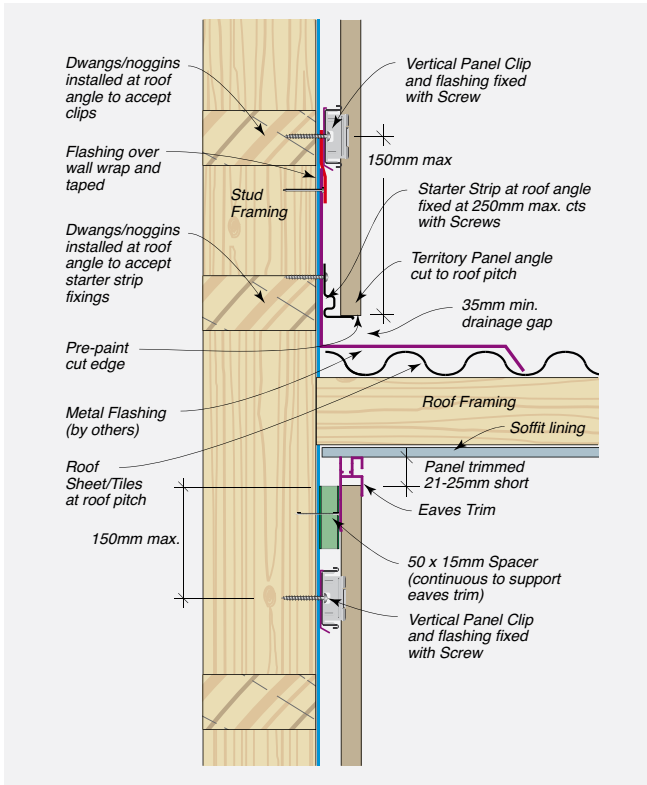

FIGURE 8.25 Junction of with External Roofing

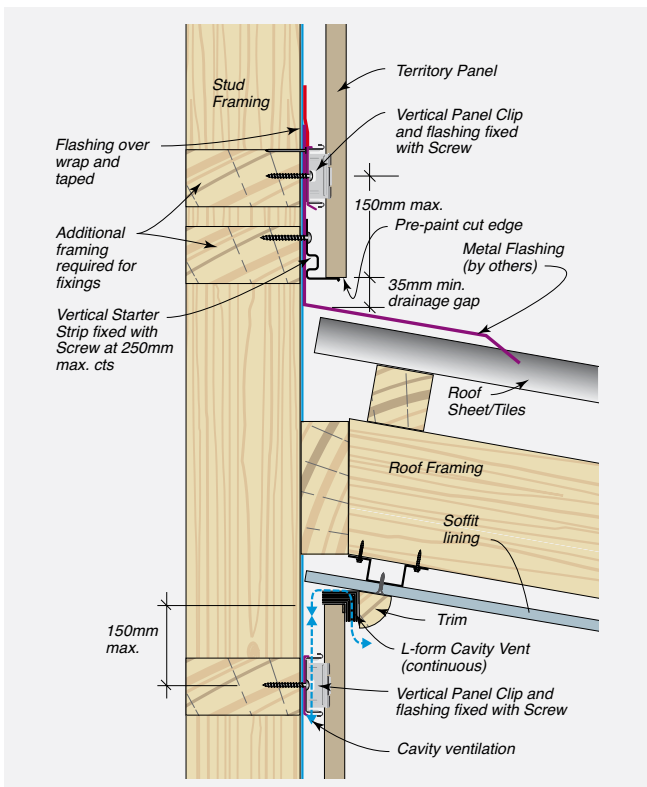

FIGURE 8.26 Two Sided Parapet Wall Junction – Plan View

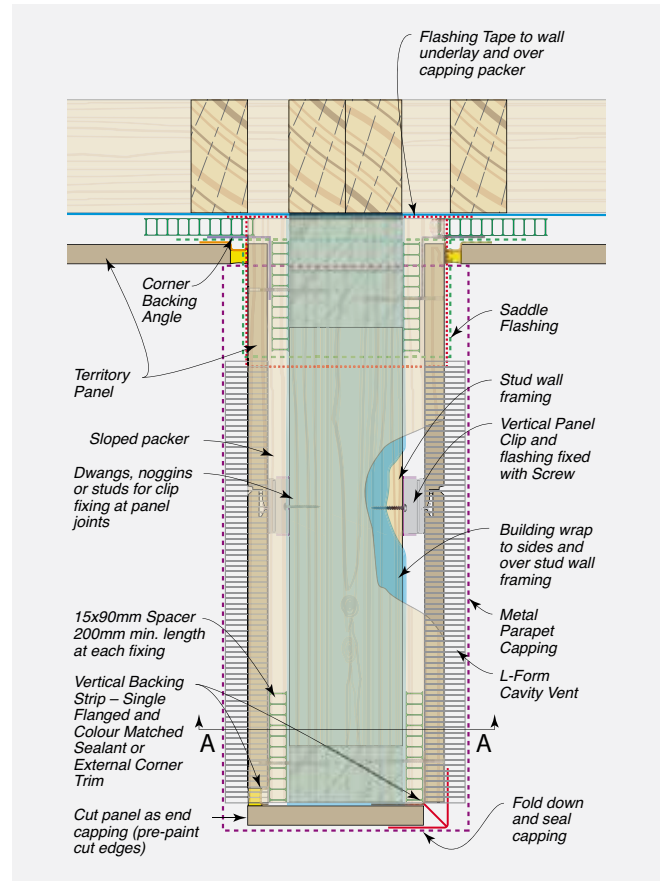
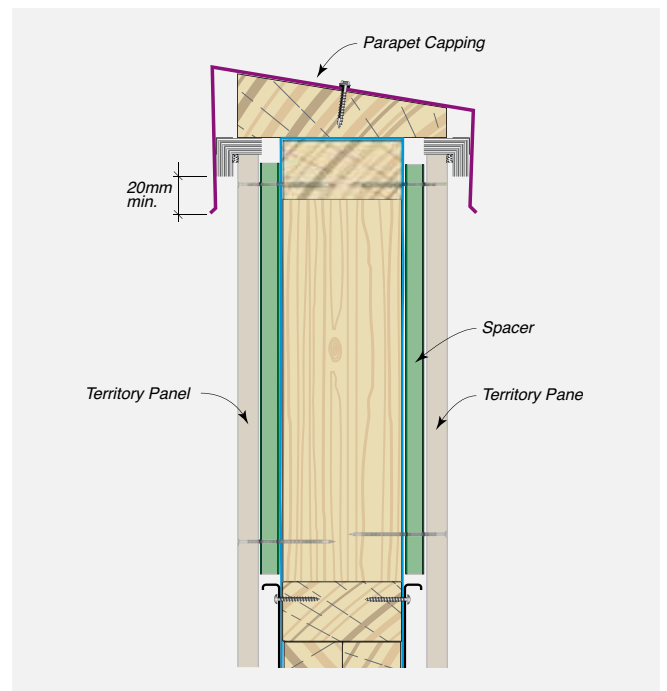

FIGURE 8.27 Two Sided Parapet – Elevation A





CONSTRUCTION DRAWINGS AND DETAILS

Note: Drawings are interchangeable for timber or steel substrates with the exception of the fasteners.

FIGURE 8.28 Two Sided Parapet Wall Junction – Stage 1 Procedure

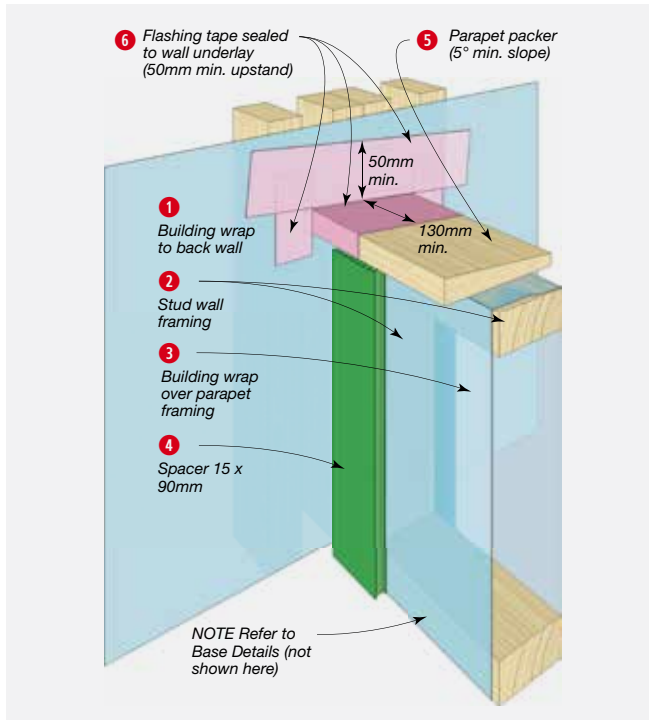

FIGURE 8.30 Two Sided Parapet Wall Junction – Stage 3 Procedure

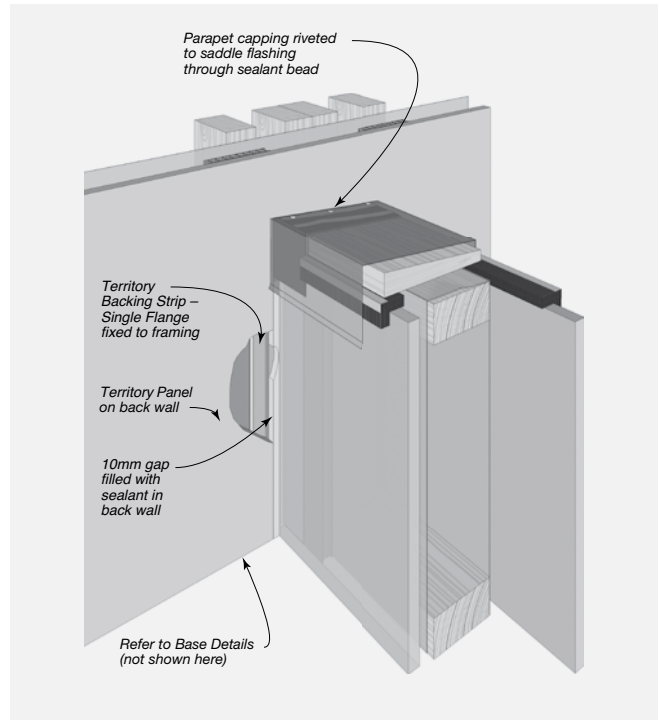
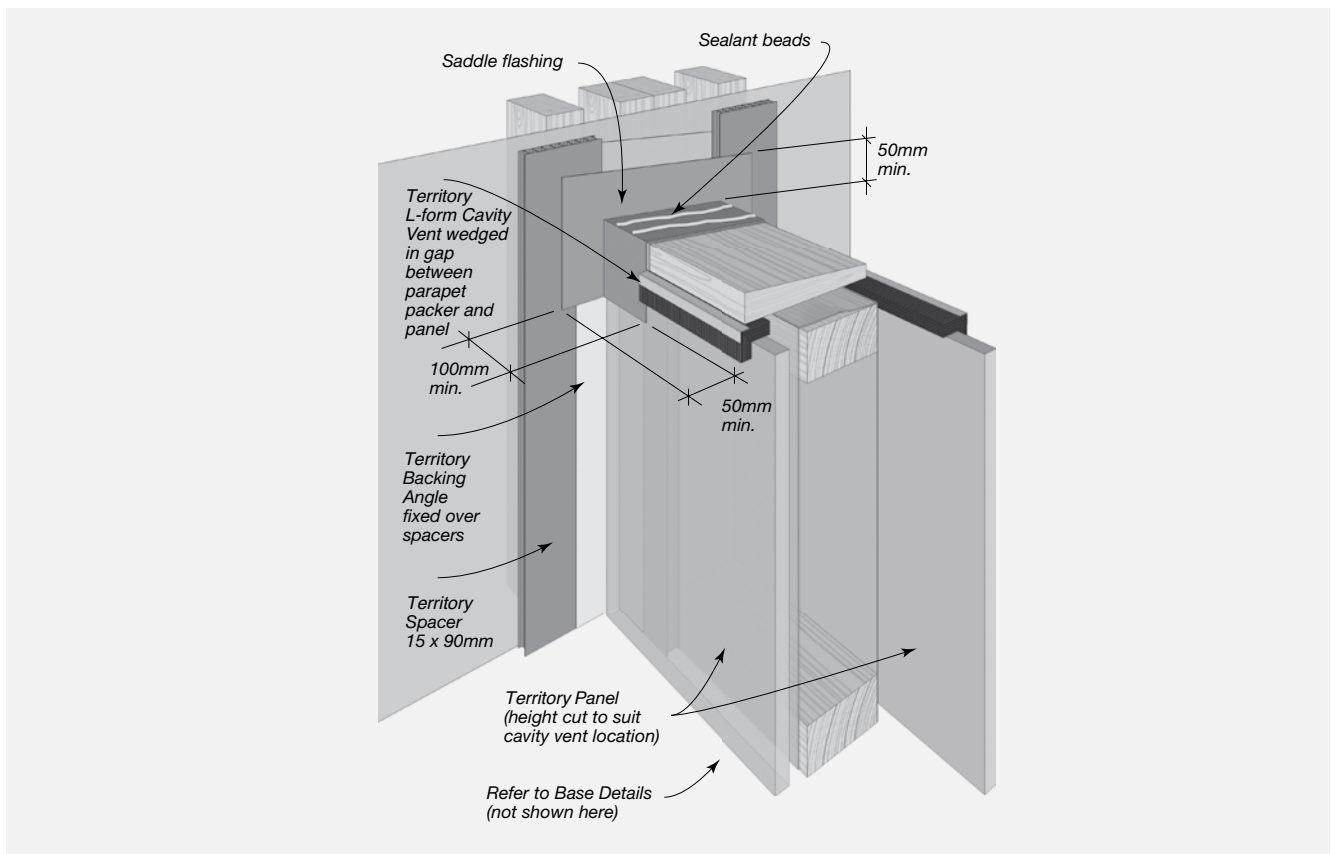

FIGURE 8.29 Two Sided Parapet Wall Junction – Stage 2 Procedure



CONSTRUCTION DRAWINGS AND DETAILS



Note: Drawings are interchangeable for timber or steel substrates with the exception of the fasteners.

FIGURE 8.31 External Corner Junction – Panel to Brick Veneer – Plan View

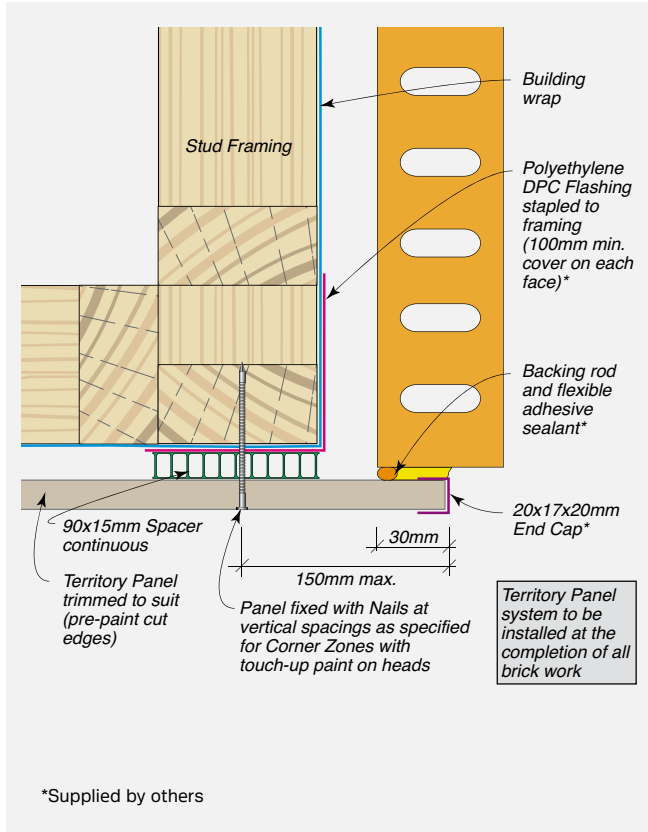

FIGURE 8.33 Internal Corner Junction – Panel to Brick Veneer – Plan View

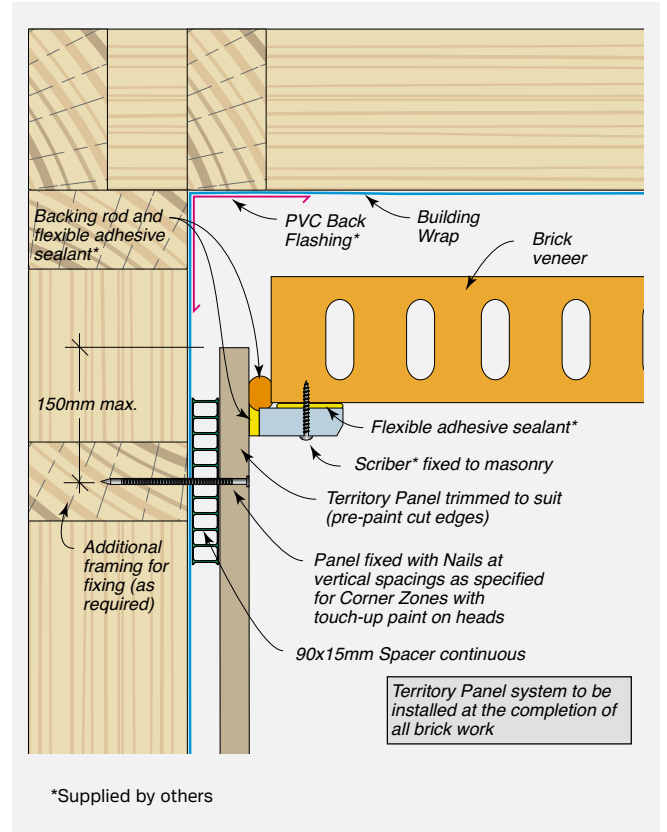
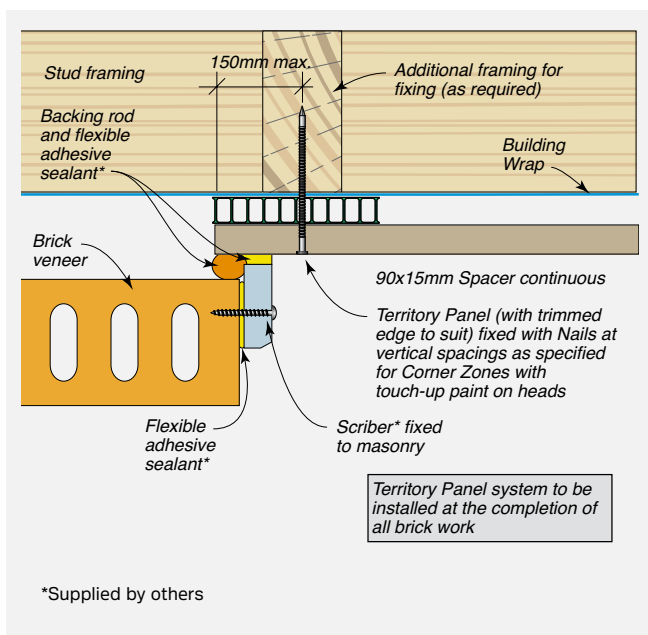

FIGURE 8.32 Typical Abutment – Panel to Brick Veneer – Plan View





CONSTRUCTION DRAWINGS AND DETAILS

Note: Drawings are interchangeable for timber or steel substrates with the exception of the fasteners.

FIGURE 8.34 Typical Internal Corner Junction Panel to Masonry Wall – Plan View

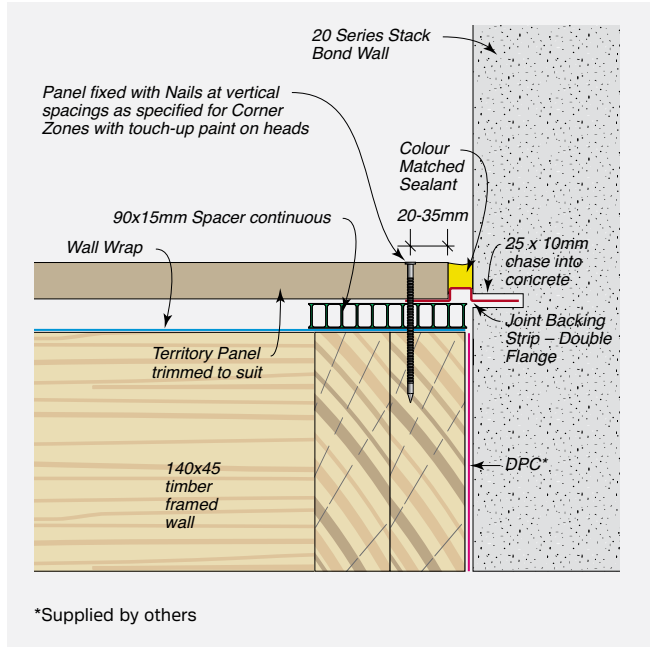

FIGURE 8.36 Typical Abutment – Panel to Weatherboard – Plan View

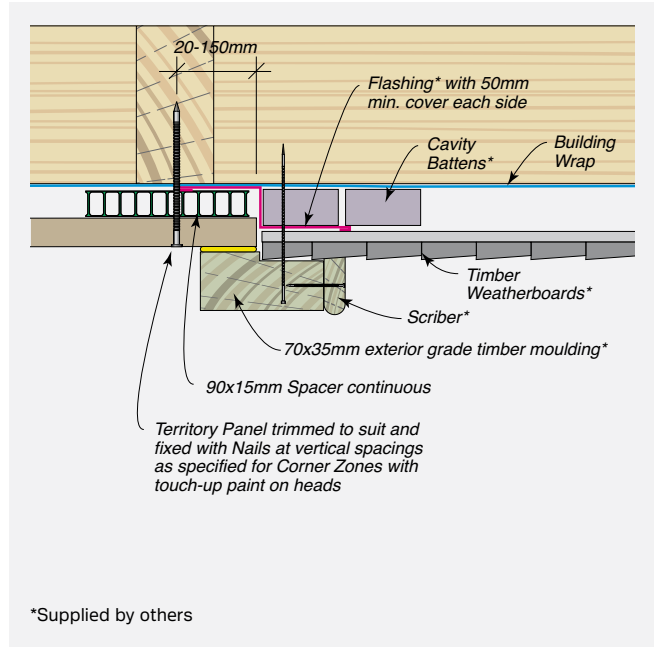

FIGURE 8.35 Typical Internal Corner Junction Panel to Weatherboard – Plan View

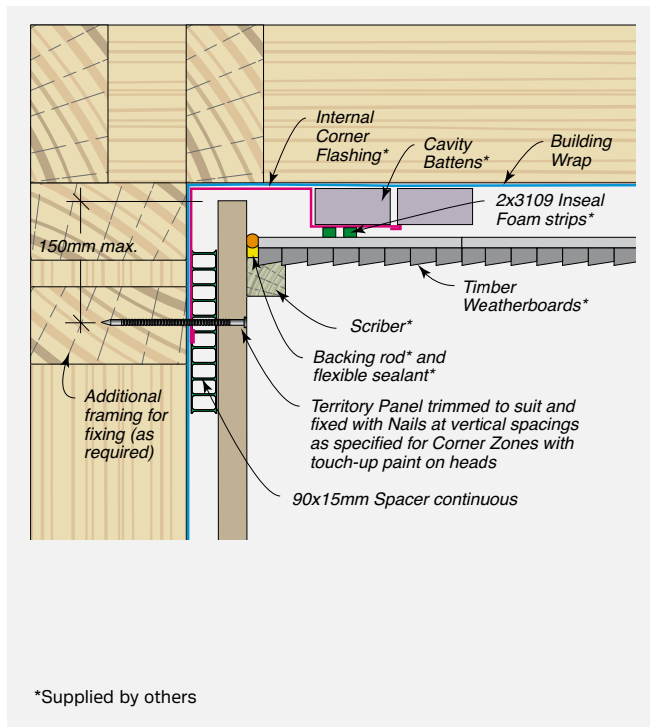
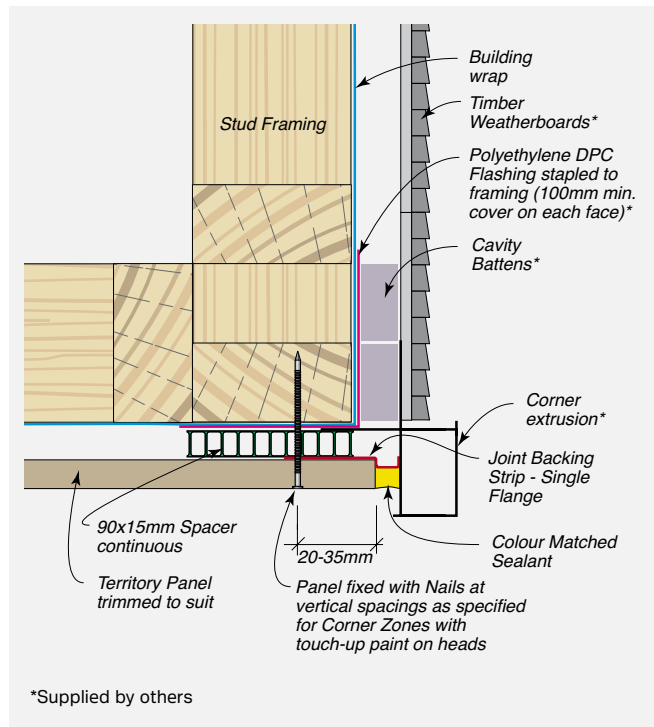

FIGURE 8.37 Typical External Corner Junction Panel to Weatherboard – Plan View



CONSTRUCTION DRAWINGS AND DETAILS



Note: Drawings are interchangeable for timber or steel substrates with the exception of the fasteners.

FIGURE 8.38 Typical Abutment with In-line or Out-set Masonry Wall – Plan View

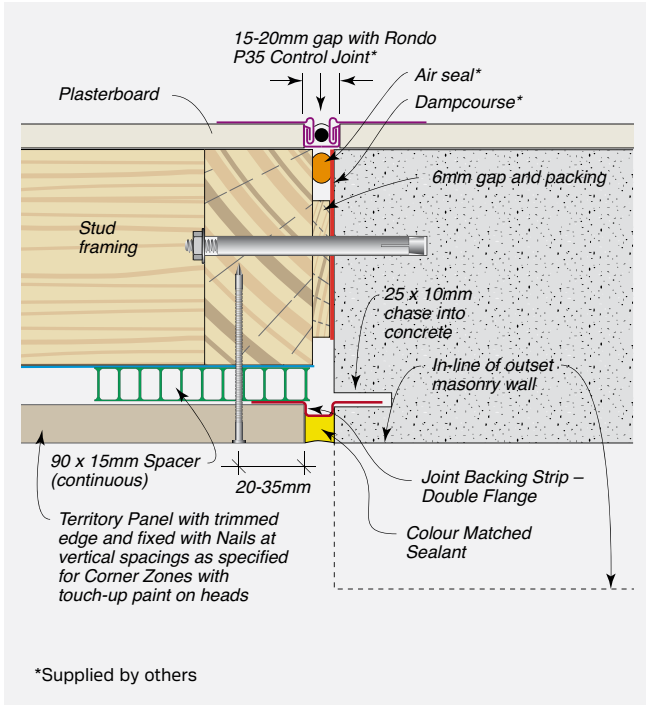

FIGURE 8.40 Typical Abutment with Direct Fixed Cladding System – Plan View

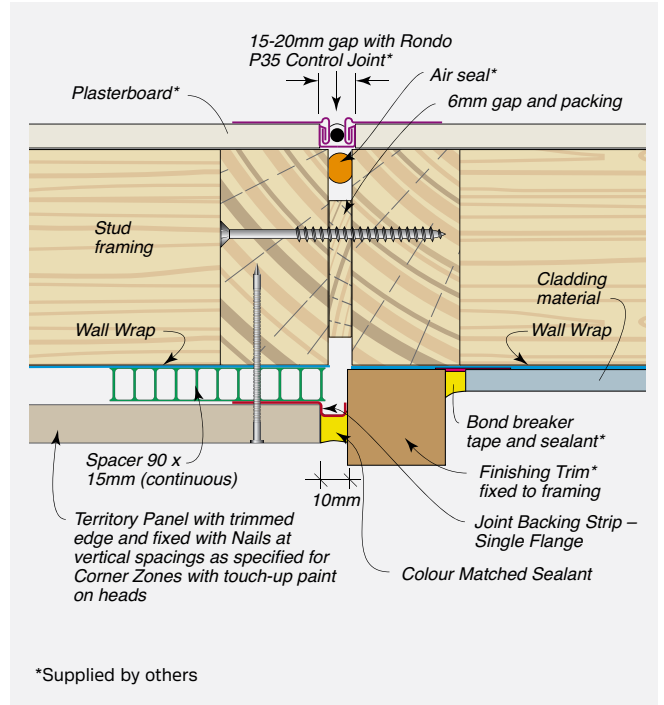
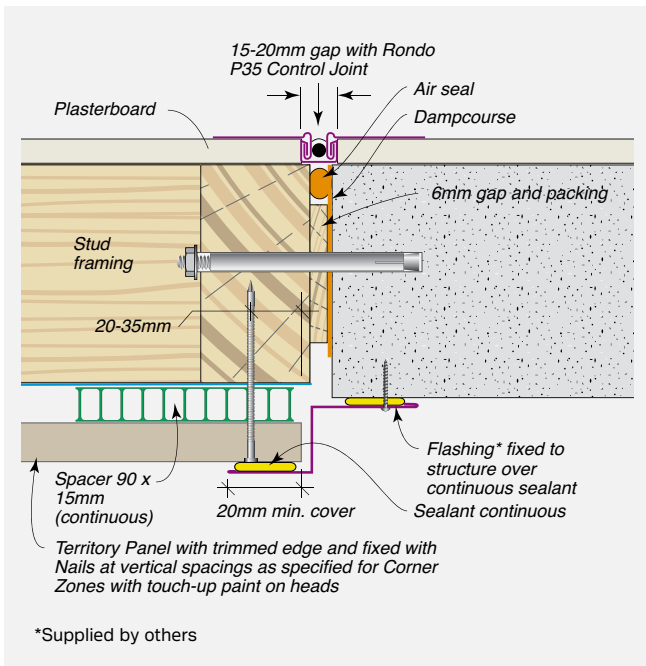

FIGURE 8.39 Typical Abutment with In-set Masonry Wall – Plan View





CONSTRUCTION DRAWINGS AND DETAILS

Note: Drawings are interchangeable for timber or steel substrates with the exception of the fasteners.

FIGURE 8.41 Base Detail - Concrete Slab Construction - Plan View

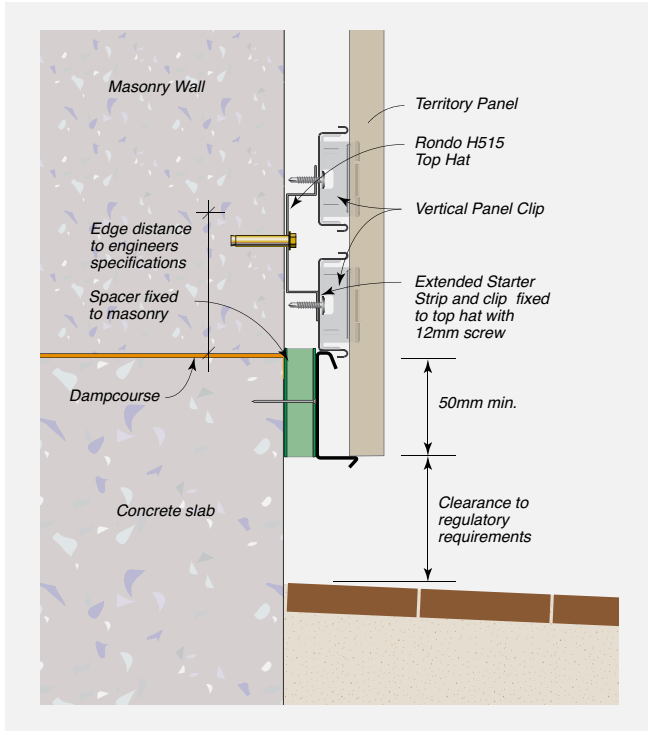

FIGURE 8.43 Horizontal Control Joint - Second Storey Junction - Open Cavity

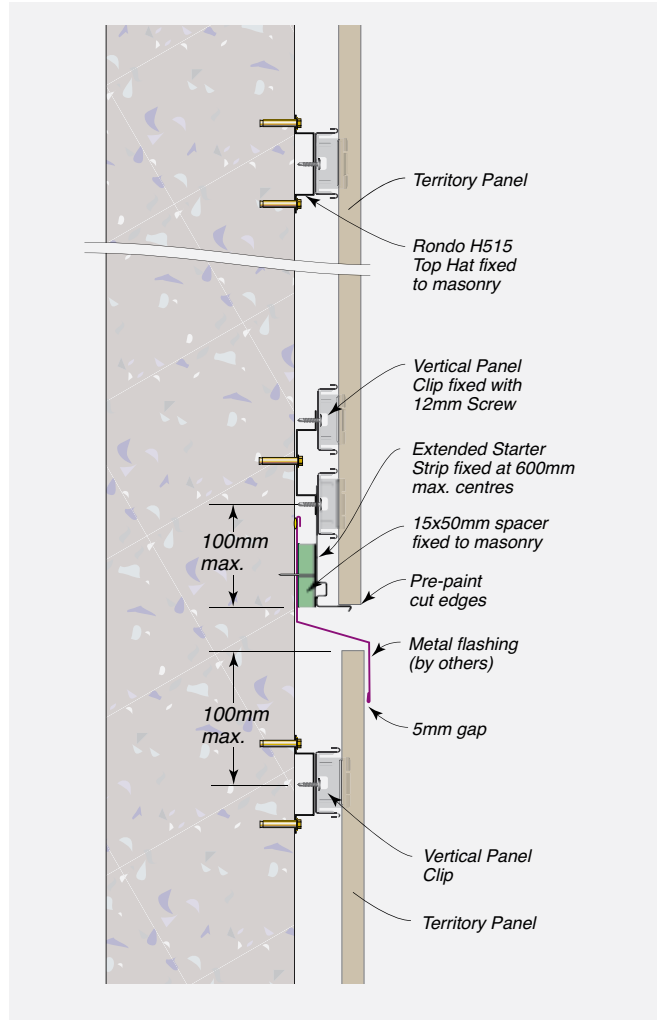
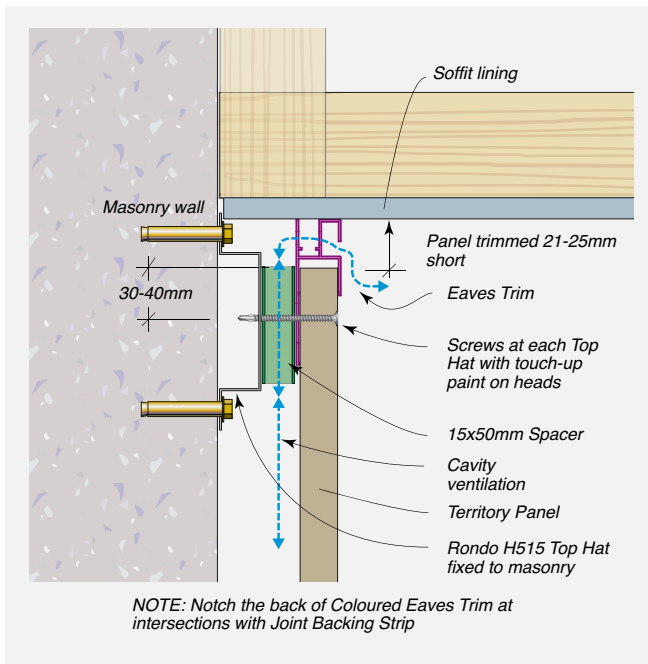

FIGURE 8.42 Soffit Detail - With Coloured Eaves Trim - Elevation



CONSTRUCTION DRAWINGS AND DETAILS



Note: Drawings are interchangeable for timber or steel substrates with the exception of the fasteners.

FIGURE 8.44 External Corner Detail – With Preformed Corner – Plan View

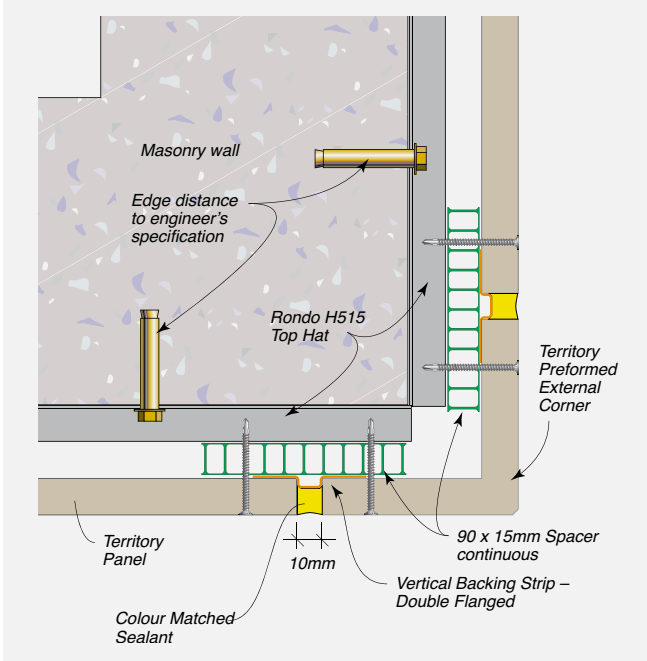

FIGURE 8.46 Internal Corner Detail – With Backing Strip and Colour Matched Sealant – Plan View

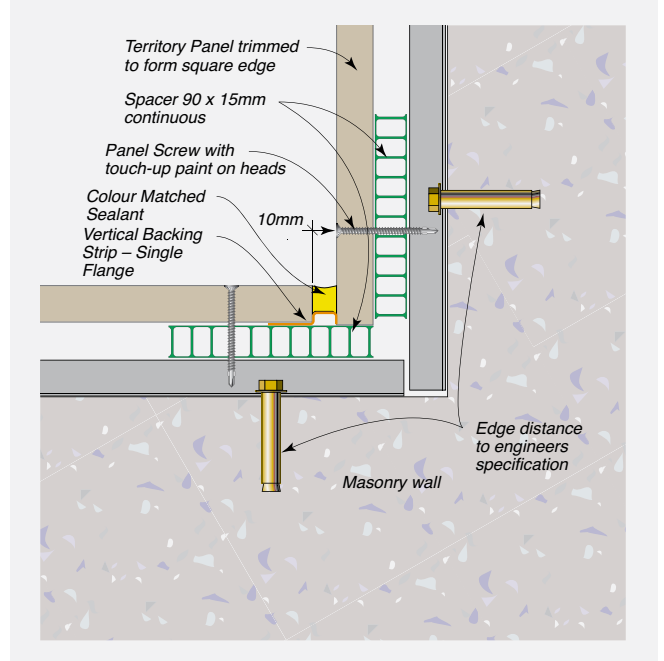

FIGURE 8.45 External Corner Detail – With Coloured External Corner Trim – Plan View

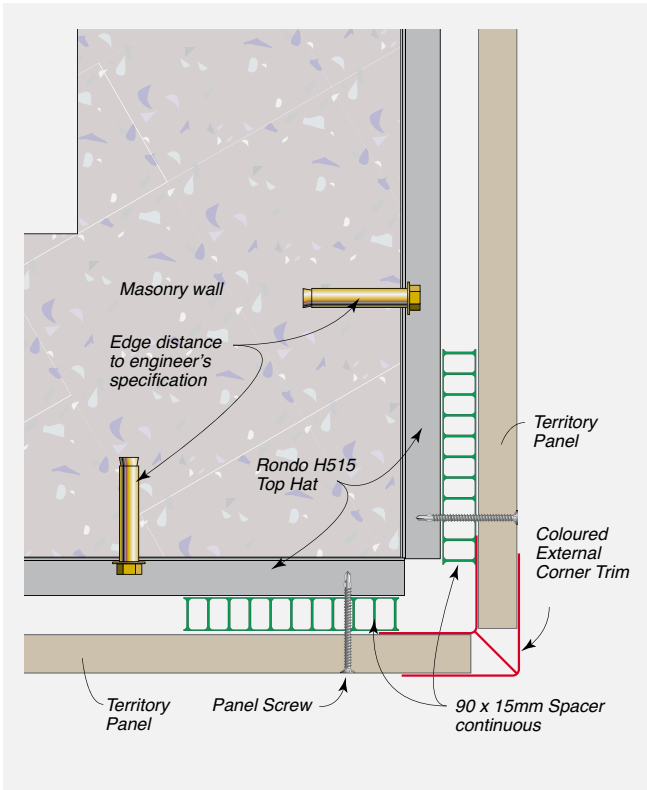
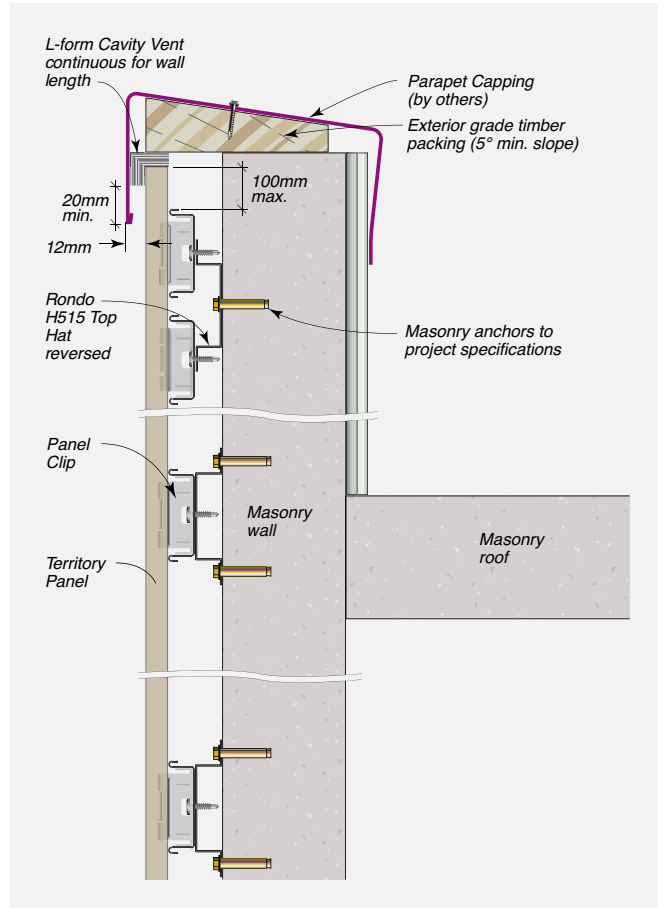

FIGURE 8.47 Parapet Detail – Elevation





CONSTRUCTION DRAWINGS AND DETAILS

Note: Drawings are interchangeable for timber or steel substrates with the exception of the fasteners.

Masonry Windows Details

FIGURE 8.48 Typical Domestic Window Head, Sill and Jamb Detail

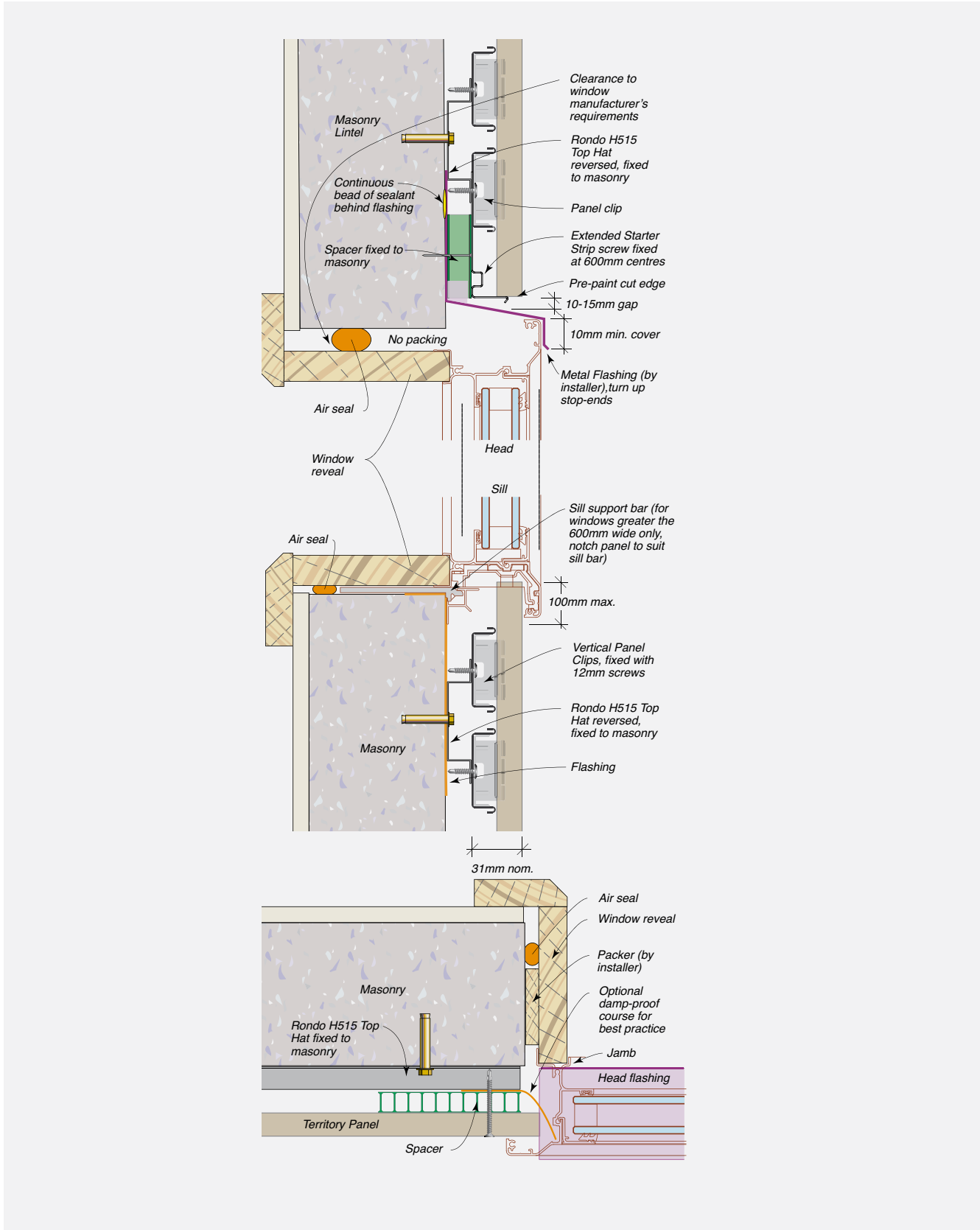

CONSTRUCTION DRAWINGS AND DETAILS



Note: Drawings are interchangeable for timber or steel substrates with the exception of the fasteners.

FIGURE 8.49 Typical Commercial Window Head, Sill and Jamb Detail

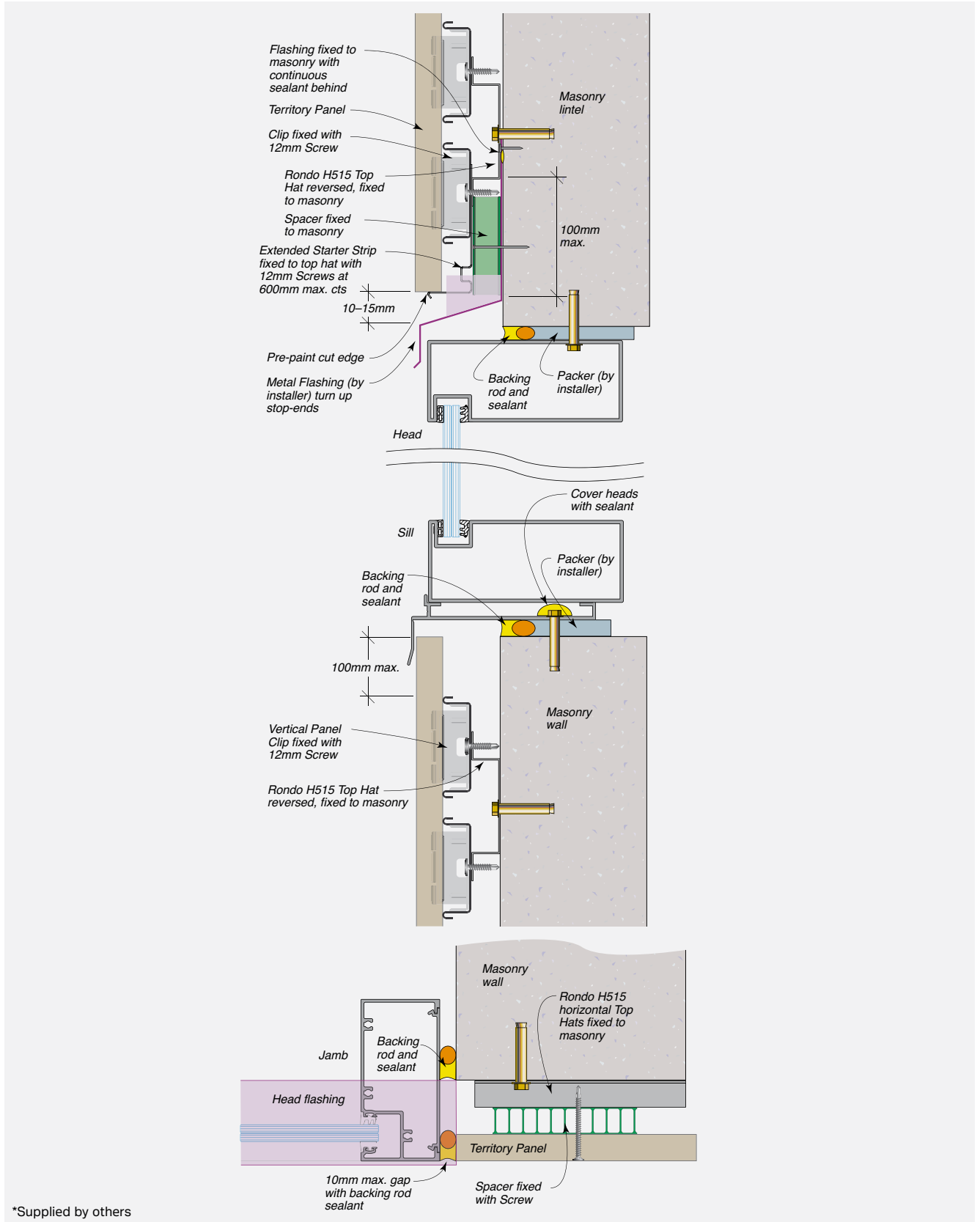

*Supplied by others



CONSTRUCTION DRAWINGS AND DETAILS

Note: Drawings are interchangeable for timber or steel substrates with the exception of the fasteners.

FIGURE 8.50 Typical Power/Meter Box - Recessed into Framing - Elevation

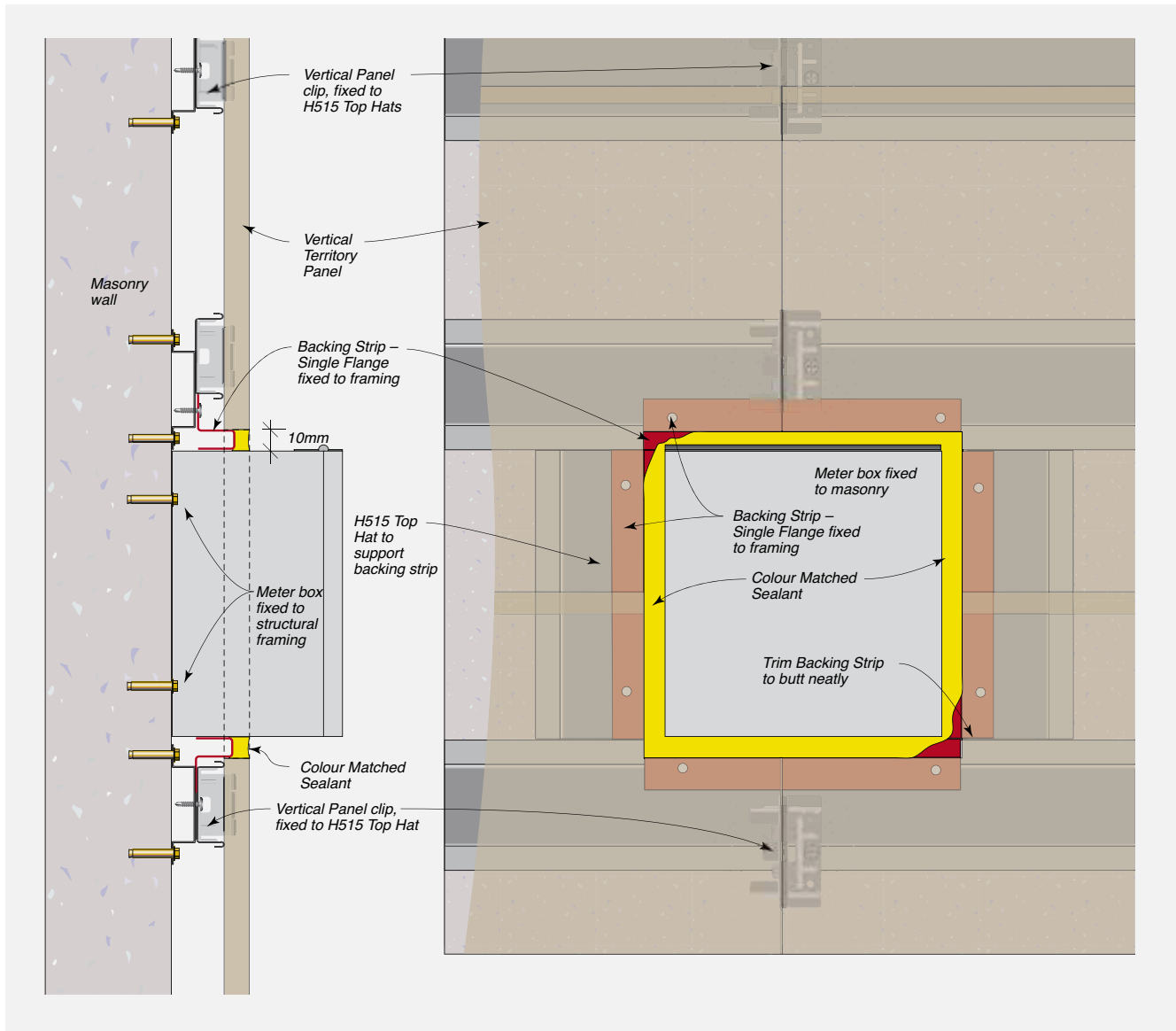



**SAFETY, HANDLING
+ GENERAL CARE**



SAFETY, HANDLING + GENERAL CARE

Health, Safety and Personal Protection Equipment (PPE)

Panels contain silicas that are harmful if inhaled. Protective clothing and breathing equipment should be worn when cutting products.

When cutting, drilling or grinding Territory panels using power tools, always ensure the work area is properly ventilated. An approved dust mask (AS/

NZS1715 and AS/NZS1716) and safety glass (AS/NZS1337) must be worn. Cemintel NZ recommends using a dust extraction system. Hearing protection should also be worn.

Safety Data Sheet information is available at cemintel.co.nz



Recommended Safe Working Practices

Cutting Outdoors	<ol style="list-style-type: none"> 1. Position cutting station so wind will blow dust away from the user or others in the working area. 2. Use a dust reducing plunge saw equipped with a dust extraction system.
Sanding/Drilling/Other Machining	When sanding, drilling or machining, you should always wear a P1 or P2 dust mask and warn others in the immediate area.
Important Reminders	<ol style="list-style-type: none"> 1. NEVER use a power saw indoors. 2. NEVER use a saw blade that is not purpose-made for cutting fibre cement products. 3. NEVER dry sweep. 4. ALWAYS follow tool manufacturers' safety recommendations. 5. ALWAYS maintain tools in a clean condition.

Handling & General Care

Storage

All Territory panels must be stacked flat, clear of the ground and supported at 300mm maximum centres on a level platform. Panels must be kept dry, preferably stored inside the building. Panels must be dry prior to fixing, hence if it is necessary to store outside, the product must be protected from the weather.

Handling

Territory panels and corners are pre-finished products and must be treated with care during handling so as to avoid damage to edges, ends and pre-finished surface. Panels should be carried horizontally on edge by two people.

As the Territory range is a pre-finished product, consideration should be given to the activity of other tradespeople. It is highly recommended that installation of Territory should always be held off until all other claddings have been completed so as to avoid damage.

Cutting

Panels should be cut from the back using a power saw. Cemintel NZ recommends using the Makita Plunge Saw or FESTO TS 55 EBQ Plunge Cut Saw with guide rail and appropriate blade. All exposed cut edges such as the window heads and roof junctions must be sealed with Cemintel edge sealer. Refer to 'Components' table for appropriate materials. **Do NOT cut with a wet saw.**

Mitreing of Panels

It is not recommended to mitre panels as this can cause delamination of the face.

Face Fixing of Panels

At face fixing points, all panels must be supported by a Spacer Strip of 200mm minimum length. Panels must be pre-drilled to accept nails. Use a 2.5mm drill bit and drill from the front. Nail/screw heads should finish flush with the panel surface. All visible nail/screw heads should be neatly covered with primer and colour-matched painted used sparingly. Do NOT use sealant on nail heads.

Penetrations

Penetrations in panels may be cut or drilled prior to installation. Cut from the back or drill from the front. Cut penetrations oversize by 8-10mm all around. Mask, prime and fill gaps with sealant in accordance with recommended methods and products.

Bevelled Edges

The top edge of panels at window sill level may require bevelling. Cemintel NZ recommends using the FESTO DSC-AGP 125 Diamond Blade Cutting & Grinding Tool.

WARRANTY, CLEANING + MAINTENANCE

10

Warranty

The Cemintel Territory panels have a product warranty of 15 years.

The full Cemintel Territory product warranty is available for download at cemintel.co.nz

Wash Down

When cleaning panels, use no more than 700psi (50kg/cm²) of water pressure at 3 to 3.5m distance from the face. Water pressure should be applied downward to avoid forcing water into tongue and groove joints.

Use neutral detergent with a soft brush when removing dirty spots from a panel. When diluting the neutral detergent, follow the manufacturer's instructions, and use the weakest solution possible.

Graffiti Protection

For walls requiring anti-graffiti protection, Cemintel NZ recommends the application of WattyI® Poly U-400 Anti-Graffiti Clear. Please refer to WattyI® for coating instructions and the warranty conditions of this product.

Recoating

If recoating in an alternative colour is desired, Cemintel NZ recommends the use of 1 coat of WattyI® Aquaprep Primer Sealer Undercoat and 2 coats of WattyI® Solagard®.

Prior to any recoating, panels should be washed down, as per the maintenance instructions, and

the coating should be applied as per WattyI® instructions.

Cemintel NZ recommends that only Territory Savanna is suitable for recoating with an alternative colour.

Inspection, Repair and Maintenance

The durability of the Cemintel Territory range can be enhanced by periodic inspection and maintenance. Inspections should include examination of the coatings, flashings and seals. Any cracked or damaged finish or seals which would allow water ingress must be repaired immediately by resealing the affected area, or by removing the panel and replacing sealant. Any damaged flashings, sheets or sealant must be replaced as for new work.

Regularly inspect panel surfaces and follow wash-down procedures when required. Small blemishes can be repaired using touch-up paint or other approved paint.

Ensure ventilation and drainage gaps between panels and flashings are clear of any debris.

It is recommended storing additional panels in case any panels are damaged in the future. Any small chips can be painted over with touch up paint which both hides the underlying panel colour and seals the panel to prevent moisture ingress.

If a whole panel needs to be replaced, the panels which sit above it will need to be removed one by one from the heading, and then reassembled with joints resealed.



Cemintel is a business division of CSR Building Products (NZ) LTD

Our Office

Auckland

14 The Furlong
Takanini
Auckland

0800 999 277

cemintel.co.nz

Disclaimer: Information presented in this document is supplied in good faith and to the best of our knowledge, was accurate at the time of preparation. Products are subject to natural variation as part of the manufacturing process. Product images may vary from actual product in regard to colour and surface finish. The provision of this information should not be construed as a recommendation to use any of our products in violation of any patent rights or in breach of any statute or regulation. Users are advised to make their own determination as to the suitability of this information in relation to their particular purpose or specific circumstances. Since the information contained in this document may be applied under conditions beyond our control, no responsibility can be accepted by Cemintel, or its staff for any loss or damage caused by any person acting or refraining from action as a result of misuse of this information.