

CLEARSPAN

CREATING SPACES
THAT INSPIRE



10
YEARS
GUARANTEE



NZ
MADE
STRUCTURES



UNIVERSAL
GLAZING SYSTEMS

CLEARSPAN

CREATING SPACES
THAT INSPIRE

The ClearSpan Structural Glazing System has been designed and manufactured in New Zealand, using quality materials.

RESIDENTIAL & COMMERCIAL



The ClearSpan Structural Glazing System is perfect for;

- Outdoor living areas
- Covered walkways
- Greenhouses
- Structural glazing including roofs & walls
- Canopies, awnings & pergolas
- Carports
- Pool covers
- Conservatories
- Gazebos
- Restaurant and Cafe Patios
- Hotel atriums
- Shopping centres
- Factories and Warehouses

OUR SYSTEMS

ClearSpan BOX

The ClearSpan Box glazing system incorporates a hollow RHS profile into its design, allowing longer runs with less structural support. The ClearSpan Box system has a range of brackets to enable this glazing system to be attached in a variety of ways.

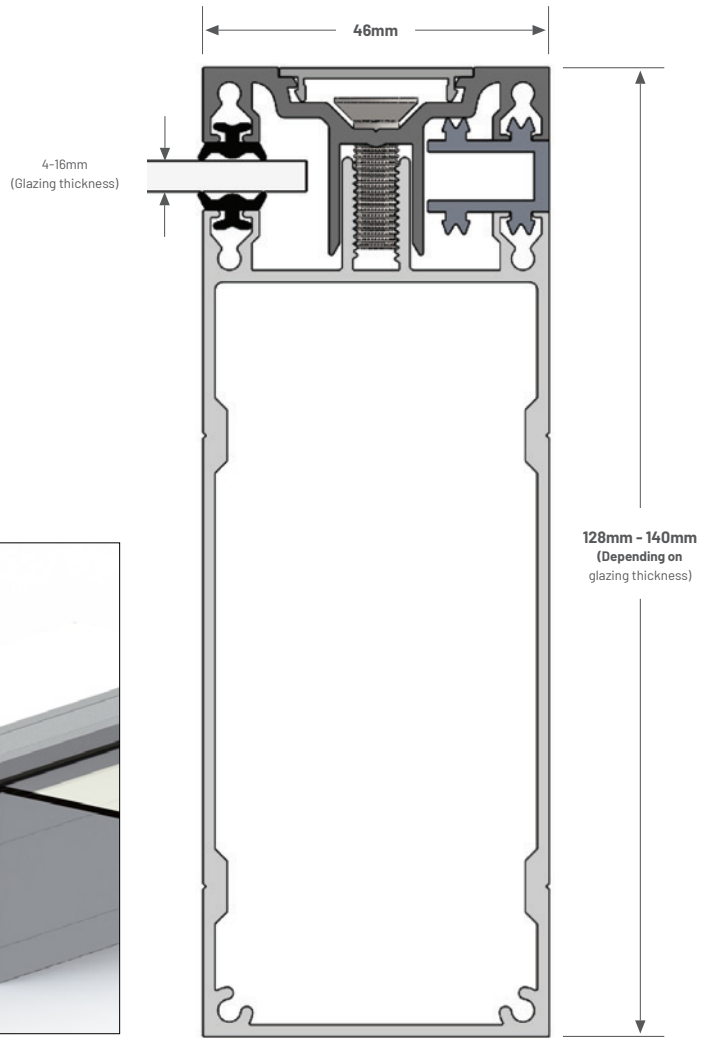
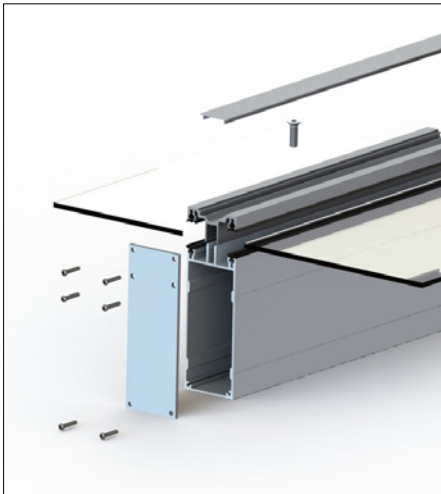

ClearSpan BAR

An effective and stylish aluminium glazing bar that provides strength and durability. The ClearSpan Bar is designed to be attached to and supported by purlins or rafters. This system is ideal as a retro-fit solution onto existing pergola and awning structures.

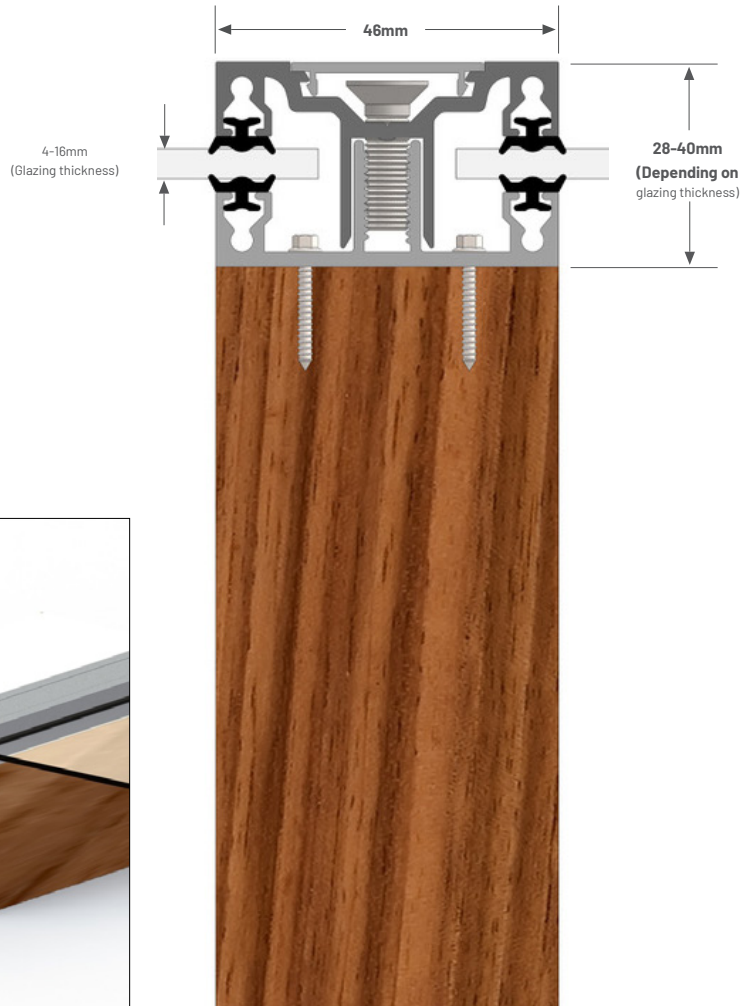

The main benefits of the ClearSpan Glazing System.

Smart system,
seamless finish and
easy to install
- perfect for the DIY

Able to supply plans,
materials, and project
management services
where required for large
scale projects

Superior
strength and
design means
you can span
further

Made from quality
materials - designed
and engineered
for New Zealand
conditions

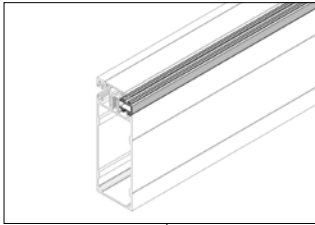

Edge Spacers

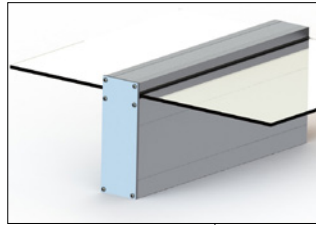

ClearSpan Box

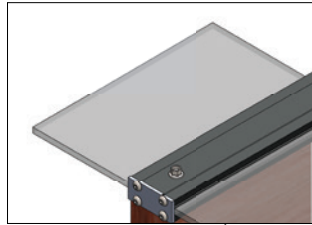

Glazing Sheet

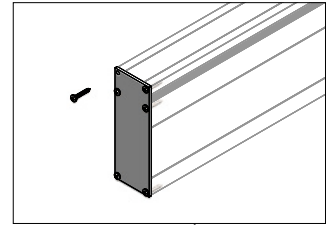

End Plates

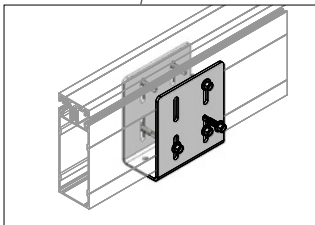

Saddle Brackets

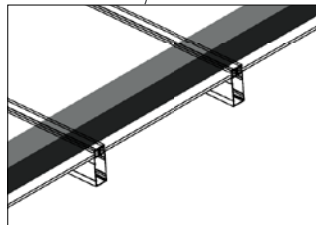

Bearer

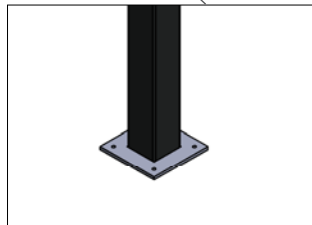

Post with Foot Plate

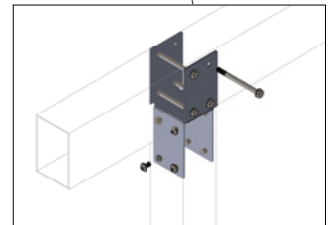

Post to Bearer Brackets

CLEARSPAN



CREATING SPACES
THAT INSPIRE

The ClearSpan Box and Bar systems are readily available in a natural aluminium finish (ready for powder coat application) in either 4050mm or 6050mm lengths.

Customised lengths and widths can be accommodated using either system.

The ClearSpan structural glazing systems are complimented by a complete range of brackets, fasteners and other ancillary extrusions designed to support the system and deliver a seamless finish.

COMPONENTS AND ACCESSORIES

Box & Bar System

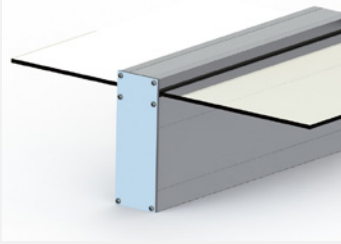

Our glazing systems include the base bar, top cap and top infill, rubber seals, compression screws and 2 end plates with screws per Box or Bar.

Glazing Sheets



We offer a wide range of glazing options including Polycarbonate, Acrylic, Toughened Safety Glass and Laminated Glass. These are available in a range of colours including Clear, Grey and Diffused Opal, depending on heat and light requirements.

Edge Spacers



Edge spacers are designed to fit in the glazing bar assembly to blank-off where no glazing will be fitted (at the edges of the roof structure).

These should be matched to the glazing thickness (ie 6mm glass would require a 6mm edge spacer). Available in lengths of 4050mm or 6050mm.

End Plates for Box & Bar

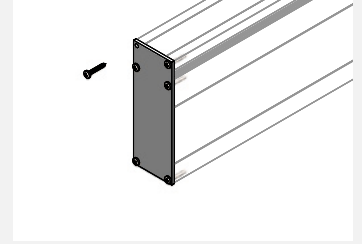

Aluminium bar end plates to suit both bar or box glazing systems. These end plates close off the end of the glazing bars and prevent the glazing sheets from creeping or moving over time. 2 End plates are included with each Box or Bar assembly.

Made from aluminium and powdercoated to match. Available to suit 4mm - 16mm glazing thickness. Supplied with ss fasteners.

Saddle Brackets

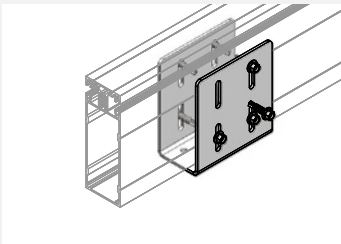

The 100mm saddle bracket is the most commonly used method for mounting the glazing box to a supporting member (bearer/beam) beneath. The bracket is supplied with 8x S/S tek-screws for bracket to glazing box attachment.

Hanger Brackets

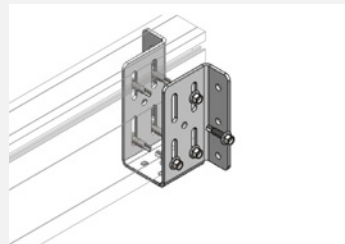

The 50mm hanger bracket attaches to the support structure or wall and supports the glazing box. Attachment between the bracket and the glazing box using the 8x S/S self drilling tek-screws (included).

Internal Brackets

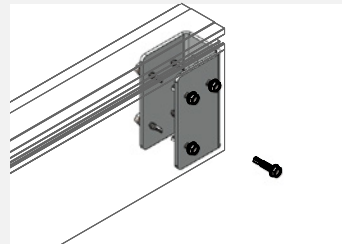

5-degree internal brackets are used with the glazing box. This aluminium bracket attaches to the support structure or wall and the glazing box sleeves over the bracket. The glazing box is fixed in position using the 4x S/S self drilling tek-screws (included). The standard bracket is set at 5-degrees but other angles are available. Because this bracket is concealed inside the glazing box, powdercoat finish is not required.

Post to Bearer Brackets

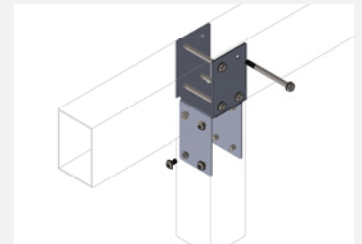

Bracket assembly for connecting 150x100 bearer/beam to 100x100 supporting post. Aluminium brackets supplied with 8x rivnuts (fitted), 8x S/S button socket screws, 16x S/S flat washers, 4x S/S hex bolts and 4x S/S nuts. Available in mill finish or powdercoated finish.

Post with Foot Plate

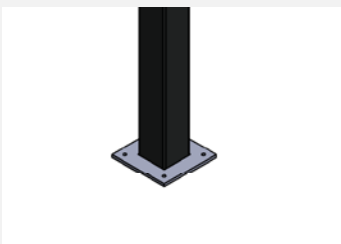

Aluminium foot plate 200x200x10mm welded onto 100x100x3mm SHS aluminium post. Has 4x bolt holes to suit M12 bolts/fasteners, and a single drain hole through the centre. Supplied in mill finish or powder coated.

Post

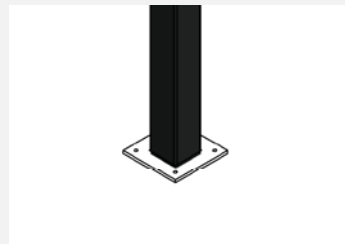

Aluminium RHS, suitable for light weight support. 100x100x3mm. 3020mm and 4050mm lengths. Square corners (no radius), supplied mill finish or powdercoated.

Bearers

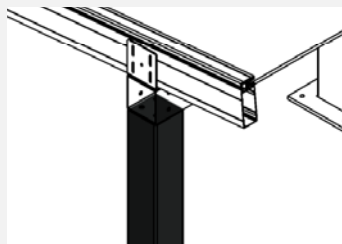

Aluminium RHS, suitable for beam/bearer support. 150x100x3mm. 4050mm and 6050mm lengths. Square corners (no radius), supplied mill finish or powdercoated.

Fasteners & Screws

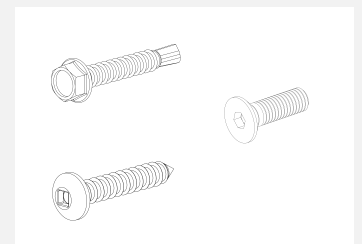

Used for attaching the glazing bar (base) to timber, steel or aluminium support structure ie purlins or rafters. Please note, these are not included in the glazing bar assemblies.

M6 stainless steel counter-sunk screws are used to compress the glazing bar and rubber seals against the glazing sheet. Please note these are included with glazing bar assemblies.

CLEARSPAN

CREATING SPACES
THAT INSPIRE



Universal Glazing Systems are at the cutting edge of the structural glazing market and the choice of many top architects.

We pride ourselves in offering a range of structural glazing solutions that create a contemporary living environment for both residential and commercial projects.

We offer a wide range of leading bespoke glazing products. Polycarbonate, Acrylic or Glass, we can cover any budget or design.

For further information including span charts, installation instructions, glazing sheet properties, retail pricing and much more, please visit our website at www.ugs.co.nz.

For any customised quotes or support contact mike@ugs.co.nz or 021 220 9517.

AVAILABLE FROM:



PHONE 0800 946 837
UGS.CO.NZ

UNIVERSAL
GLAZING SYSTEMS