

CTNCA 

NovaArquitectura & arquitectos



TÉCNICO · TECHNICAL

---

CTNCA 

TÉCNICO · TECHNICAL



TECHNIQUE · TECHNISCHE

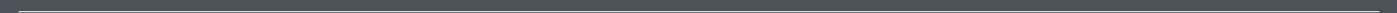

# ÍNDICE

CTINCA 

## NovaArquitectura

LADRILHOS VIDRADOS INGELIVOS ACETINADOS · SATIN FINISH FROST RESISTANT GLAZED STONEWARE TILES  
CARREAUX INGÉLIFS EN GRÈS FIN VITRIFIÉ, ÉMAILLÉ, SATINÉ · FROSTSICHERE, GLASIERTE STEINZEUGFLIESE IN SEIDENMATT



PRÉ-CORTADO · PRE-FORMED  
PRÉ-COUPÉ · RASTERFUGE



ANTIDERRAPANTE · ANTI-SLIP  
ANTIDÉRAPANT · TRITTSICHER



PEÇAS ESPECIAIS · TRIM PIECES  
PIÈCES SPÉCIALES · FORMSTÜCKE

20

## arquitectos

AZULEJOS DE PASTA BRANCA BICOZEDURA BRILHANTE/MATE · GLOSSY/MATT DOUBLE FIRED WHITE BODY WALL TILES  
FAÏENCES EN PÂTE BLANCHE BI-CUISSON BRILLANT/MAT · WEISS-SCHERBIGE ZWEIBRAND STEINGUTFLIESEN GLÄNZEND/MATT



PEÇAS ESPECIAIS · TRIM PIECES  
PIÈCES SPÉCIALES · FORMSTÜCKE

34

PIANO LISTÉIS · BORDERS  
LISTELS · BORDÜREN



# NovaArquitectura

LADRILHOS VIDRADOS INGELIVOS ACETINADOS · SATIN FINISH FROST RESISTANT GLAZED STONEWARE TILES  
 CARREAUX INGÉLIFS EN GRÈS FIN VITRIFIÉ, ÉMAILLÉ, SATINÉ · FROSTSICHERE, GLASIERTE STEINZEUGFLIESE IN SEIDENMATT

M 60×60 cm  
 24"×24"  
 W 597×597×10 mm



M 30×30 cm  
 12"×12"  
 W 297×297×7 mm



M 10×30 cm  
 4"×12"  
 W 97×297×7 mm



M 20×20 cm  
 8"×8"  
 W 197×197×6 mm



M 10×20 cm  
 4"×8"  
 W 97×197×6 mm



M 15×15 cm  
 6"×6"  
 W 147×147×6 mm



M 10×10 cm  
 4"×4"  
 W 97×97×6 mm



APLICAÇÃO · APPLICATION · APPLICATION · VERLEGUNG  
 ACABAMENTO · FINISH · FINITION · OBERFLÄCHE



LADRILHOS VIDRADOS INGELIVOS  
 FROST RESISTANT GLAZED STONEWARE TILES

EN 14411: 2012 ANNEX H GROUP BI<sub>b</sub> GL  
 ISO 13006: 2012 ANNEX H GROUP BI<sub>b</sub> GL  
 ANSI A137.1-2012 CLASS P2 (VITREOUS)

54 CORES  
 54 COLOURS

ACETINADO  
 SATIN FINISH

07 FORMATOS  
 07 FORMATS

MODULAR  
 MODULAR

CARREAUX INGÉLIFS EN GRÈS FIN VITRIFIÉ, ÉMAILLÉ  
 FROSTSICHERE, GLASIERTE STEINZEUGFLIESE

EN 14411: 2012 ANNEX H GROUP BI<sub>b</sub> GL  
 ISO 13006: 2012 ANNEX H GROUP BI<sub>b</sub> GL  
 ANSI A137.1-2012 CLASS P2 (VITREOUS)

54 COLORIS  
 54 FARBEN

SATINÉ  
 SEIDENMATT

07 FORMATS  
 07 FORMATE

MODULAIRE  
 MODUL



# NovaArquitectura

LADRILHOS VIDRADOS INGELIVOS ACETINADOS · SATIN FINISH FROST RESISTANT GLAZED STONEWARE TILES  
 CARREAUX INGÉLIFS EN GRÈS FIN VITRIFIÉ, ÉMAILLÉ, SATINÉ · FROSTSICHERE, GLASIERTE STEINZEUGFLIESE IN SEIDENMATT  
 EN 14411: 2012 ANNEX H GROUP B16 GL · ISO 13006:2012 ANNEX H GROUP B16 GL · ANSI A137.1-2012 CLASS P2 (VITREOUS)



Todos os artigos com a referência sublinhada estão disponíveis em revestimento coordenado (consultar pág. 26 a 33) e os artigos com \* existem apenas no formato M20x20 cm.

All items where the product code is underlined have a matching wall tile (see pages 26 to 33). Items marked with an \* are only available in size M20x20 cm.

Tous les articles soulignés sont disponibles en faïence coordonnée (consulter de la page 26 à 33), et les articles signalés \* n'existent qu'en format M20x20 cm.

Die unterstrichenen Artikelnummern sind auch als kombinierbare Wandfliesen erhältlich (siehe Seite 26 bis 33). Die Artikel mit \* gibt es nur im Format M20x20 cm.



Este produto também se encontra disponível em ladrilho de porcelanato vidrado ingelivo acetinado.

This product is also available in Glazed Porcelain.

Ce produit peut être fourni également en grès cérame fin vitrifié ingélif, émaillé, satiné.

Dieser Artikel ist auch als frostsicheres, glasiertes Feinsteinzeug in seidenmatt erhältlich.

EN 14411:2012 Annex G Group B1a GL  
 ISO 13006:2012 Annex G Group B1a GL  
 ANSI A137.1-2012 Class P1 (Impervious - Porcelain)

Formato · Format	Caixa · Box			Paleta · Pallet				
	Pcs. · Stk.	m²	kg	Caixa / Paleta Box / Pallet	m²	Net. kg	Brut. kg	cm
Pavimento · Floor Tiles Carreaux de Sol · Bodenfliese	M20x20x0,6 cm M10x20x0,6 cm	25 50	1,00 1,00	12,64 12,77	84 84	1.062 1.073	1.087 1.098	120x80x73 120x80x74

02 FORMATOS · 02 FORMATS  
 02 FORMATS · 02 FORMATE

M20x20 cm  
 8" x 8"  
 W 197 x 197 x 6 mm

M 10x20 cm  
 4" x 8"  
 W 97 x 197 x 6 mm



54 CORES · 54 COLOURS  
 54 COLORIS · 54 FARBEN

Cores disponíveis em stock · Colours available in stock  
 Coloris disponibles en stock · Farben sind Lagerware

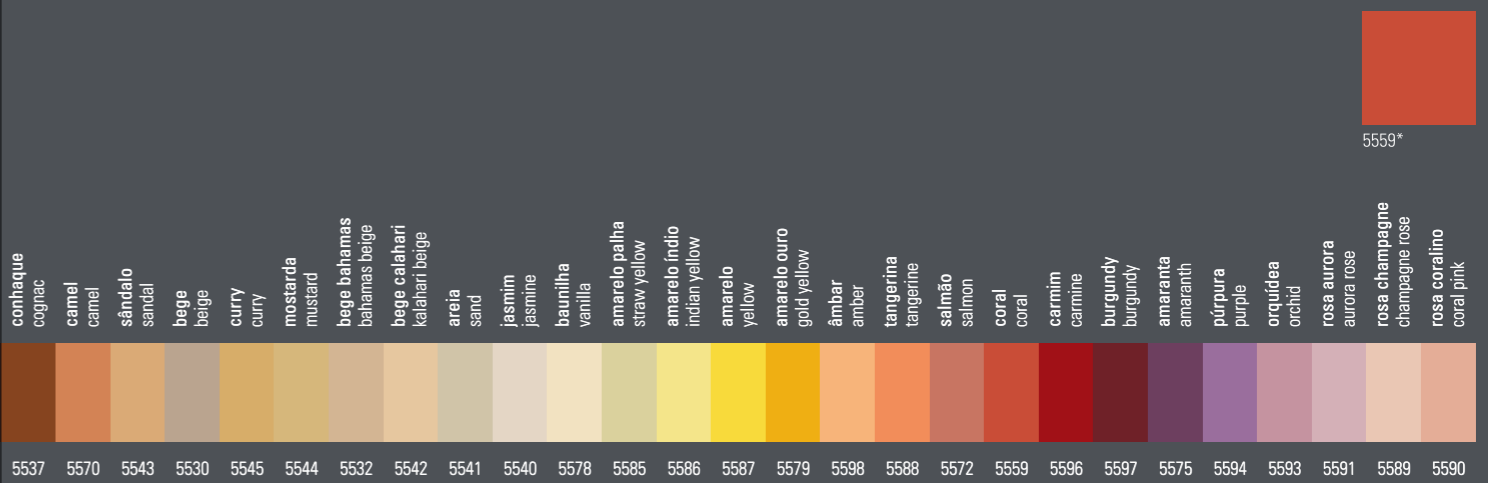
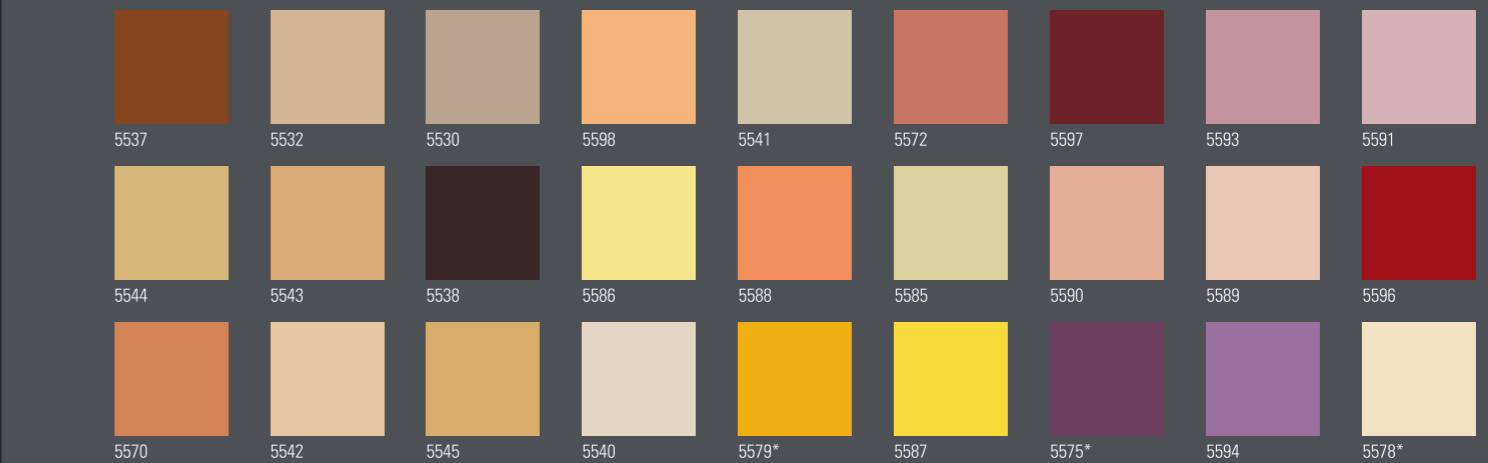
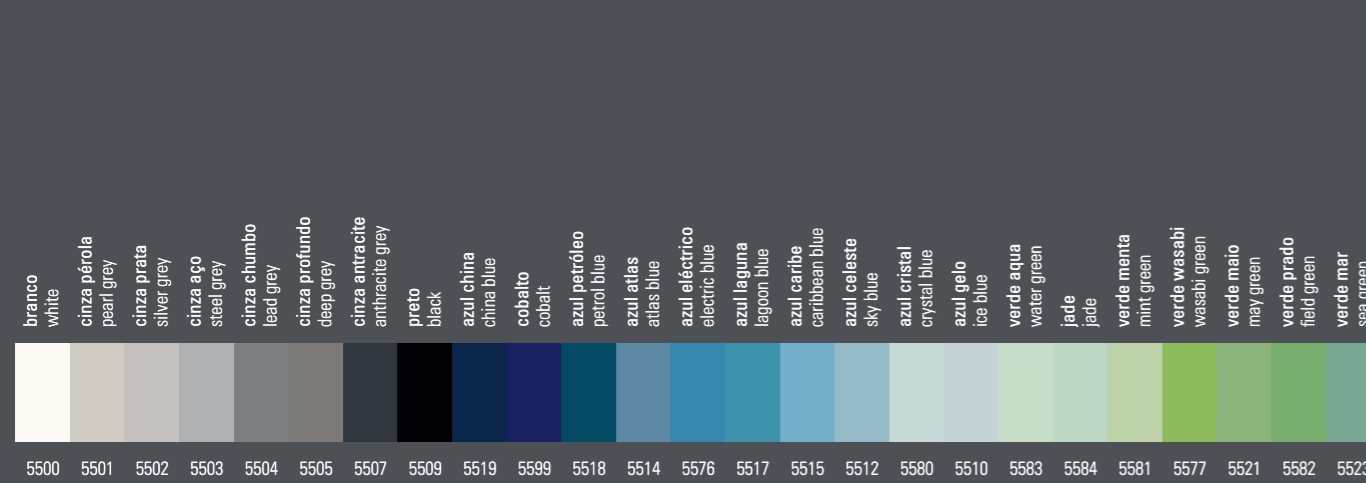
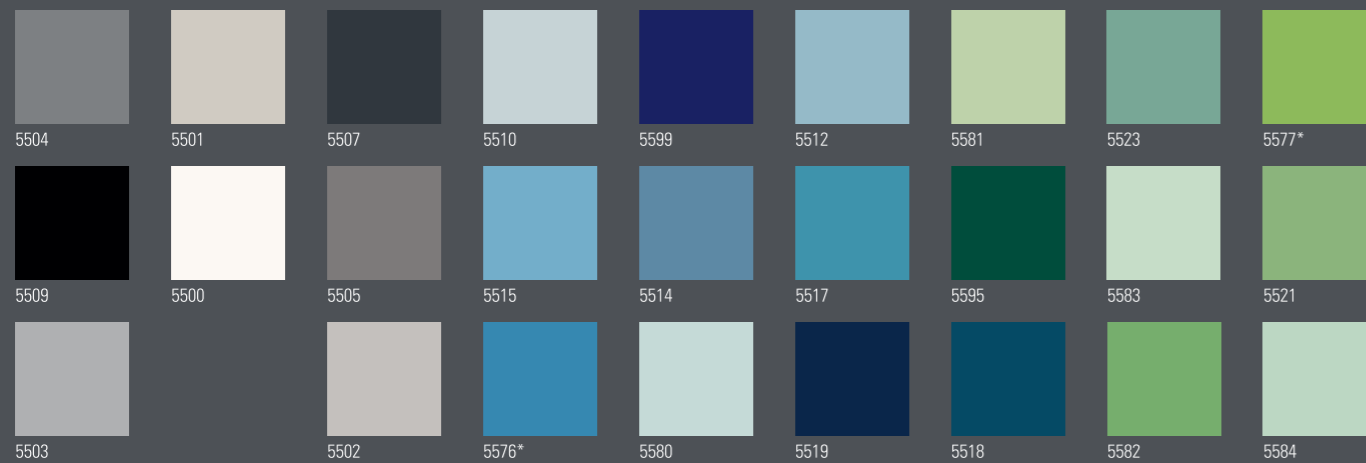

# NovaArquitectura

LADRILHOS VIDRADOS INGELIVOS ACETINADOS · SATIN FINISH FROST RESISTANT GLAZED STONEWARE TILES  
 CARREAUX INGÉLIFS EN GRÈS FIN VITRIFIÉ, ÉMAILLÉ, SATINÉ · FROSTSICHERE, GLASIERTE STEINZEUGFLIESE IN SEIDENMATT  
 EN 14411: 2012 ANNEX H GROUP B16 GL · ISO 13006:2012 ANNEX H GROUP B16 GL · ANSI A137.1-2012 CLASS P2 (VITREOUS)



Todos os artigos com a referência sublinhada estão disponíveis em revestimento coordenado (consultar pág. 26 a 33).

All items where the product code is underlined have a matching wall tile (see pages 26 to 33).

Tous les articles soulignés disposent d'un revêtement coordonné (consulter de la page 26 à 33).

Die unterstrichenen Artikelnummern sind auch als kombinierbare Wandfliesen erhältlich (siehe Seite 26 bis 33).



Este produto também se encontra disponível em ladrilho de porcelanato vidrado ingelivo acetinado.

This product is also available in Glazed Porcelain.

Ce produit peut être fourni également en grès cérame fin vitrifié ingélif, émaillé, satiné.

Dieser Artikel ist auch als frostsicheres, glasiertes Feinsteinzeug in seidenmatt erhältlich.

EN 14411:2012 Annex G Group B1a GL  
 ISO 13006:2012 Annex G Group B1a GL  
 ANSI A137.1-2012 Class P1 (Impervious - Porcelain)

Formato · Format	Caixa · Box			Paleta · Pallet					
	Pcs. · Stk.	m²	kg	Caixa / Paleta Box / Pallet	m²	Net. kg	Brut. kg	cm	
Pavimento · Floor Tiles Carreaux de Sol · Bodenfliese	M60×60×1 cm	3	1,08	24,30	36	38,88	875	900	120×80×74
	M30×30×0,7 cm	15	1,35	20,15	50	67,50	1.008	1.033	120×80×73
	M10×30×0,7 cm	50	1,50	21,80	48	72,00	1.046	1.071	120×80×73
	M15×15×0,6 cm	44	1,00	12,34	80	80,00	987	1.012	120×80×73

04 FORMATOS · 04 FORMATS  
 04 FORMATS · 04 FORMATE

M60×60 cm  
 24"×24"  
 W 597×597×10 mm

M30×30 cm  
 12"×12"  
 W 297×297×7 mm

M10×30 cm  
 4"×12"  
 W 97×297×7 mm

M15×15 cm  
 6"×6"  
 W 147×147×6 mm



27 CORES · 27 COLOURS  
 27 COLORIS · 27 FARBEN

Cores disponíveis em stock · Colours available in stock  
 Coloris disponibles en stock · Farben sind Lagerware

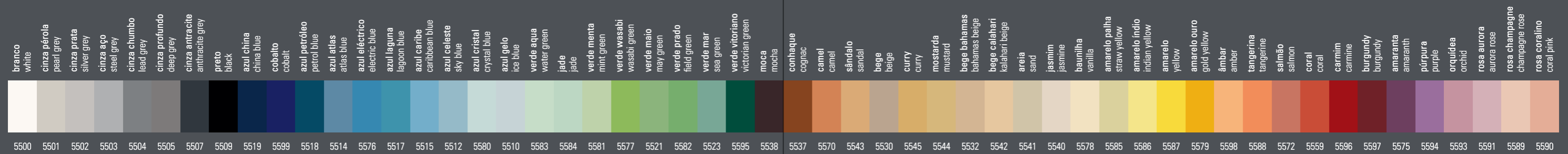
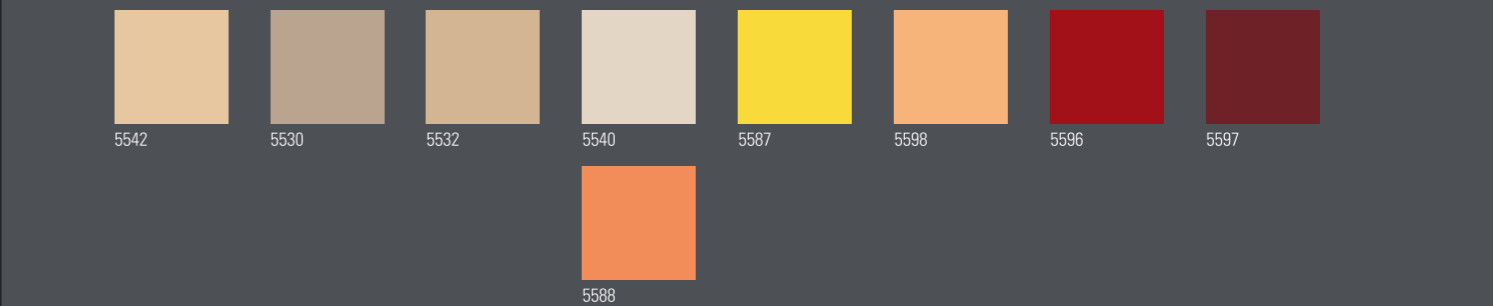
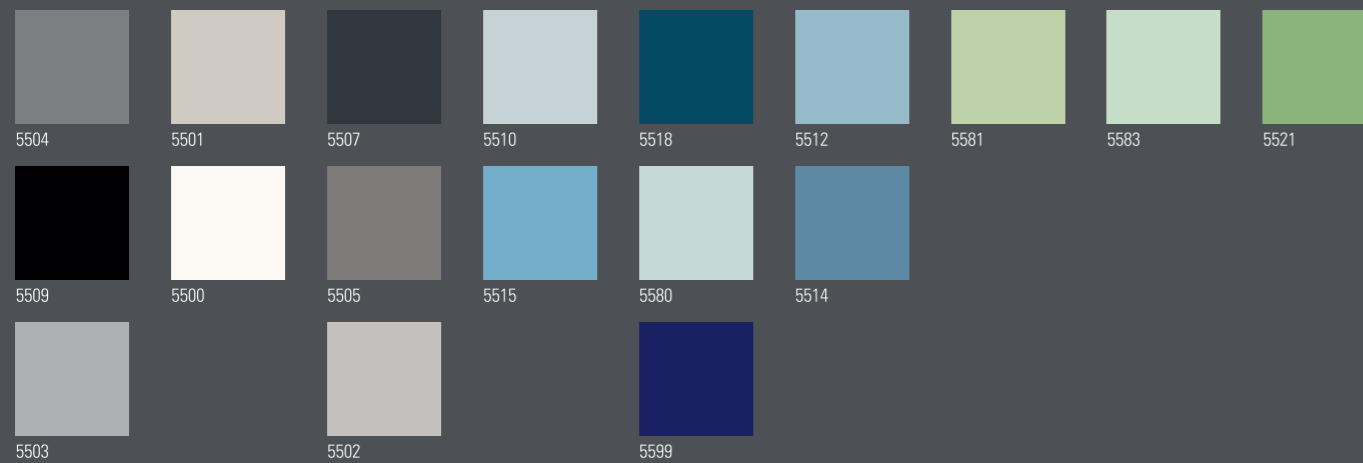

# NovaArquitectura

LADRILHOS VIDRADOS INGELIVOS ACETINADOS · SATIN FINISH FROST RESISTANT GLAZED STONEWARE TILES  
 CARREAUX INGÉLIFS EN GRÈS FIN VITRIFIÉ, ÉMAILLÉ, SATINÉ · FROSTSICHERE, GLASIERTE STEINZEUGFLIESE IN SEIDENMATT  
 EN 14411: 2012 ANNEX H GROUP B16 GL · ISO 13006:2012 ANNEX H GROUP B16 GL · ANSI A137.1-2012 CLASS P2 (VITREOUS)



Produto colado em papel perfurado. Placas de aproximadamente 30×30 cm, 3×3 peças. Todos os artigos com a referência sublinhada estão disponíveis em revestimento coordenado (consultar pág. 26 a 33).

Product glued on paper mesh. Sheets of approximately 30×30 cm, 3×3 pieces. All items where the product code is underlined have a matching wall tile (see pages 26 to 33).

Produit collé sur papier perforé. Plaques d'environ 30×30 cm, 3×3 pièces. Tous les articles soulignés disposent d'un revêtement coordonné (consulter de la page 26 à 33).

Artikel geklebt auf Netzpapier, Matten ca. 30×30 cm, 3×3 Stück. Die unterstrichenen Artikelnummern sind auch als kombinierbare Wandfliesen erhältlich (siehe Seite 26 bis 33).



Este produto também se encontra disponível em ladrilho de porcelanato vidrado ingelivo acetinado.

This product is also available in Glazed Porcelain.

Ce produit peut être fourni également en grès cérame fin vitrifié ingélif, émaillé, satiné.

Dieser Artikel ist auch als frostsicheres, glasiertes Feinsteinzeug in seidenmatt erhältlich.

EN 14411:2012 Annex G Group B1a GL  
 ISO 13006:2012 Annex G Group B1a GL  
 ANSI A137.1-2012 Class P1 (Impervious - Porcelain)

Formato · Format	Caixa · Box			Paleta · Pallet					
	Pcs. · Stk.	m <sup>2</sup>	kg	Caixa / Paleta Box / Pallet	m <sup>2</sup>	Net. kg	Brut. kg	cm	
Pavimento · Floor Tiles Carreaux de Sol · Bodenfliese	M 10×10×0,6 cm	99	1,00	12,50	78	78,00	975	1.000	120×80×82

01 FORMATO · 01 FORMAT  
 01 FORMAT · 01 FORMAT

M 10×10 cm  
 4"×4"  
 W 97×97×6 mm



11 CORES · 11 COLOURS  
 11 COLORIS · 11 FARBEN

Cores disponíveis em stock · Colours available in stock  
 Coloris disponibles en stock · Farben sind Lagerware

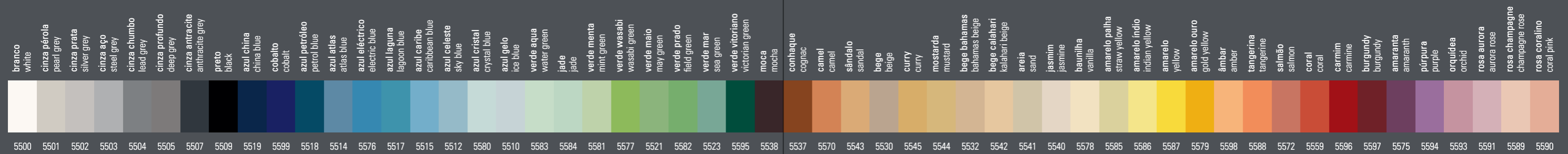
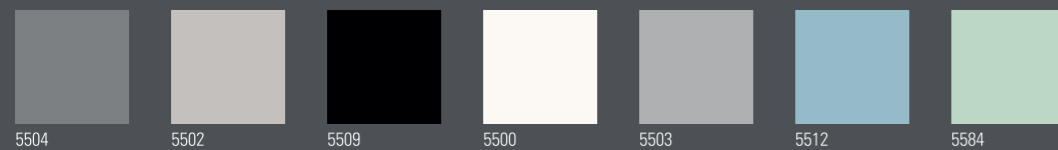

# NovaArquitectura

PRÉ-CORTADO · PRE-FORMED · PRÉ-COUPÉ · RASTERFUGE

LADRILHOS VIDRADOS INGELIVOS ACETINADOS · SATIN FINISH FROST RESISTANT GLAZED STONEWARE TILES

CARREAUX INGÉLIFS EN GRÈS FIN VITRIFIÉ, ÉMAILLÉ, SATINÉ · FROSTSICHERE, GLASIERTE STEINZEUGFLIESE IN SEIDENMATT

EN 14411:2012 ANNEX H GROUP B1b GL · ISO 13006:2012 ANNEX H GROUP B1b GL · ANSI A137.1-2012 CLASS P2 (VITREOUS)



Para uma boa aplicação, a largura da junta deve ser igual à largura da junta das ranhuras. Todos os artigos com a referência sublinhada estão disponíveis em revestimento coordenado (consultar pág. 26 a 33).

In order to achieve a good application result, the width of the grout joint should be equal to the joints in the pre-formed tile.

All items where the product code is underlined have a matching wall tile (see pages 26 to 33).

Pour une application correcte, la largeur du joint doit être égale à la largeur du joint des rainures. Tous les articles soulignés disposent d'un revêtement coordonné (consulter de la page 26 à 33).

Bei der Verlegung darauf achten, dass die Fuge die gleiche Größe hat wie die vorgefrägte Fuge. Die unterstrichenen Artikelnummern sind auch als kombinierbare Wandfliesen erhältlich (siehe Seite 26 bis 33).



Este produto também se encontra disponível em ladrilho de porcelanato vidrado ingelivo acetinado.

This product is also available in Glazed Porcelain.

Ce produit peut être fourni également en grès cérame fin vitrifié ingélif, émaillé, satiné.

Dieser Artikel ist auch als frostsicheres, glasiertes Feinsteinzeug in seidenmatt erhältlich.

EN 14411:2012 Annex G Group B1a GL  
ISO 13006:2012 Annex G Group B1a GL  
ANSI A137.1-2012 Class P1 (Impervious - Porcelain)

Formato · Format	Caixa · Box			Paleta · Pallet				
	Pcs. · Stk.	m <sup>2</sup>	kg	Caixa / Paleta Box / Pallet	m <sup>2</sup>	Net. kg	Brut. kg	cm
M20×20×0,6 cm	25	1,00	12,64	84	84,00	1.062	1.087	120×80×73

01 FORMATO · 06 SUB-FORMATOS · 01 SIZE · 06 SUB-SIZES

01 FORMAT · 06 SOUS-FORMATS · 01 FORMAT · 06 UNTERFORMATE

M20×20 cm  
8"×8"

W 197×197×6 mm

10 × 10 cm  
ref./10



5 × 20 cm  
ref./520



5 × 10 cm  
ref./510



5 × 5 cm  
ref./5



2,5 × 5 cm  
ref./255



2,5 × 2,5 cm  
ref./2,5

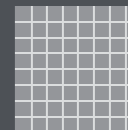

19 CORES · 19 COLOURS

19 COLORIS · 19 FARBEN

Cores disponíveis em stock · Colours available in stock

Coloris disponibles en stock · Farben sind Lagerware

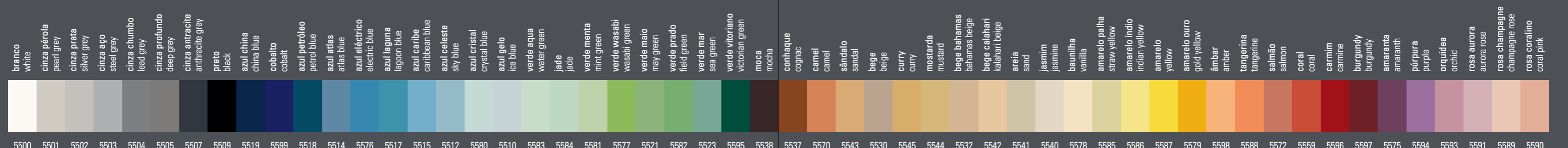
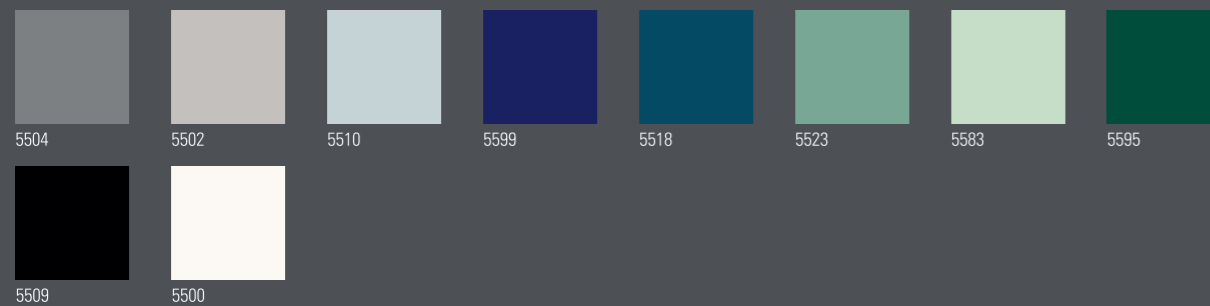





# NovaArquitectura

ANTIDERRAPANTE · ANTI-SLIP · ANTIDÉRAPANTE · TRITTSICHER

LADRILHOS VIDRADOS INGELIVOS · FROST RESISTANT GLAZED STONEWARE TILES

CARREAUX INGÉLIFS EN GRÈS FIN VITRIFIÉ, ÉMAILLÉ · FROSTSICHERE, GLASIERTE STEINZEUGFLIESE

EN 14411: 2012 ANNEX H GROUP BIb GL · ISO 13006:2012 ANNEX H GROUP BIb GL · ANSI A137.1-2012 CLASS P2 (VITREOUS)



Todos os artigos com a referência sublinhada estão disponíveis em revestimento coordenado (consultar pág. 26 a 33).  
\* cores existentes no formato M 10×10 cm. Produto colado em papel perfurado. Placas de aproximadamente 30×30 cm, 3×3 peças.

All items where the product code is underlined have a matching wall tile (see pages 26 to 33).  
\* existing colours in format M 10×10 cm. Product glued on paper mesh. Sheets of approximately 30×30 cm, 3×3 pieces.

Tous les articles soulignés disposent d'un revêtement coordonné (consulter de la page 26 à 33).  
\* coloris existantes dans le format M 10×10 cm. Produit collé sur papier perforé. Plaques d'environ 30×30 cm, 3×3 pièces.

Die unterstrichenen Artikelnummern sind auch als kombinierbare Wandfliesen erhältlich (siehe Seite 26 bis 33).  
\* Farben erhältlich in M 10×10 cm. Artikel geklebt auf Netzpapier, Matten ca. 30×30 cm, 3×3 Stück.

NovaArquitectura
REF AD
55XX AD = 56XX

Formato · Format	Caixa · Box			Paleta · Pallet					
	Pcs. · Stk.	m <sup>2</sup>	kg	Caixa / Paleta Box / Pallet	m <sup>2</sup>	Net. kg	Brut. kg	cm	
Pavimento · Floor Tiles	M20×20×0,6 cm	25	1,00	12,64	84	84,00	1.062	1.087	120×80×73
Carreaux de Sol · Bodenfliese	M10×20×0,6 cm	50	1,00	12,77	84	84,00	1.073	1.098	120×80×74
	M10×10×0,6 cm	99	1,00	12,50	78	78,00	975	1.000	120×80×82

03 FORMATOS · 03 FORMATS

03 FORMATS · 03 FORMATE

M 20×20 cm AD  
8"×8"  
W 197×197×6 mm

M 10×20 cm AD  
4"×8"  
W 97×197×6 mm

M 10×10 cm AD  
4"×4"  
W 97×97×6 mm



04 CORES · 04 COLOURS

04 COLORIS · 04 FARBEN

Cores disponíveis em stock · Colours available in stock

Coloris disponibles en stock · Farben sind Lagerware

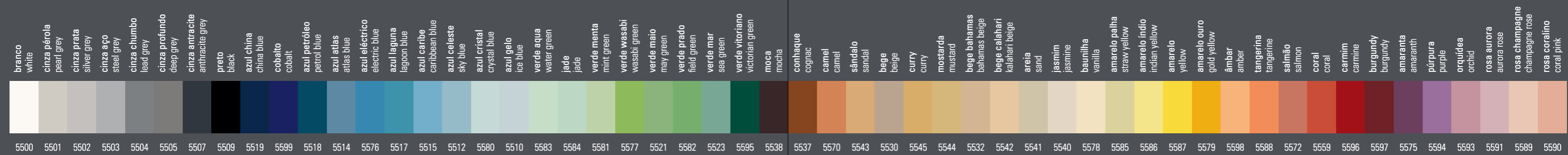

Este tipo de produto é requerido por razões de segurança e prevenção de acidente especialmente em áreas cuja função exija uma superfície resistente à derrapância. É indicado para condições húmidas e molhadas, em espaços públicos ou habitacionais. Recomendado para áreas de chuveiros e banheiros.

This product type is a requirement for areas where safety is of major importance. It provides an anti-slip surface which helps to prevent accidents. Recommended for humid or wet areas in public or residential areas: for example shower areas and dressing rooms.

Ce type de produit est requis pour des raisons de sécurité et prévention d'accidents, spécialement dans des endroits dont la fonction exige une surface résistante à l'antidérapance. Il est indiqué dans des conditions humides et mouillées, dans des espaces publics ou logements. Recommandé pour les douches et bains publics.

Dieser Produkttyp ist für Bereiche gedacht, in denen die Sicherheit von großer Bedeutung ist. Es bietet eine rutschfeste Oberfläche, die hilft, Unfälle zu vermeiden. Empfohlen für Feucht- und Nassbereiche in öffentlichen oder privaten Gebäuden, beispielsweise Duschbereiche und Umkleieräume.



Este produto também se encontra disponível em ladrilho de porcelanato vidrado ingelivo acetinado.

This product is also available in Glazed Porcelain.

Ce produit peut être fourni également en grès cérame fin vitrifié ingélif, émaillé, satiné.

Dieser Artikel ist auch als frostsichere, glasiertes Feinsteinzeug in seidenmatt erhältlich.

EN 14411:2012 Annex G Group BIa GL  
ISO 13006:2012 Annex G Group BIa GL  
ANSI A137.1-2012 Class P1 (Impervious - Porcelain)

# NovaArquitectura

ANTIDERRAPANTE · ANTI-SLIP · ANTIDÉRAPANTE · TRITTSICHER

LADRILHOS VIDRADOS INGELIVOS · FROST RESISTANT GLAZED STONEWARE TILES

CARREAUX INGÉLIFS EN GRÈS FIN VITRIFIÉ, ÉMAILLÉ · FROSTSICHERE, GLASIERTE STEINZEUGFLIESE

EN 14411: 2012 ANNEX H GROUP B1b GL · ISO 13006:2012 ANNEX H GROUP B1b GL · ANSI A137.1-2012 CLASS P2 (VITREOUS)



Todos os artigos com a referência sublinhada estão disponíveis em revestimento coordenado (consultar pág. 26 a 33).

All items where the product code is underlined have a matching wall tile (see pages 26 to 33).

Tous les articles soulignés disposent d'un revêtement coordonné (consulter de la page 26 à 33).

Die unterstrichenen Artikelnummern sind auch als kombinierbare Wandfliesen erhältlich (siehe Seite 26 bis 33).

<b>NovaArquitectura</b>
<b>REF AD</b>
55XX AD = 56XX

Formato · Format	Caixa · Box			Paleta · Pallet				
	Pcs. · Stk.	m²	kg	Caixa / Paleta Box / Pallet	m²	Net. kg	Brut. kg	cm
Pavimento · Floor Tiles Carreaux de Sol · Bodenfliese M 15×15×0,6 cm	44	1,00	12,34	80	80,00	987	1.012	120×80×73

01 FORMATO · 01 FORMAT

01 FORMAT · 01 FORMAT

M15×15cm AD

6"×6"

W 147×147×6mm



10 CORES · 10 COLOURS

10 COLORIS · 10 FARBEN

Cores disponíveis em stock · Colours available in stock

Coloris disponibles en stock · Farben sind Lagerware

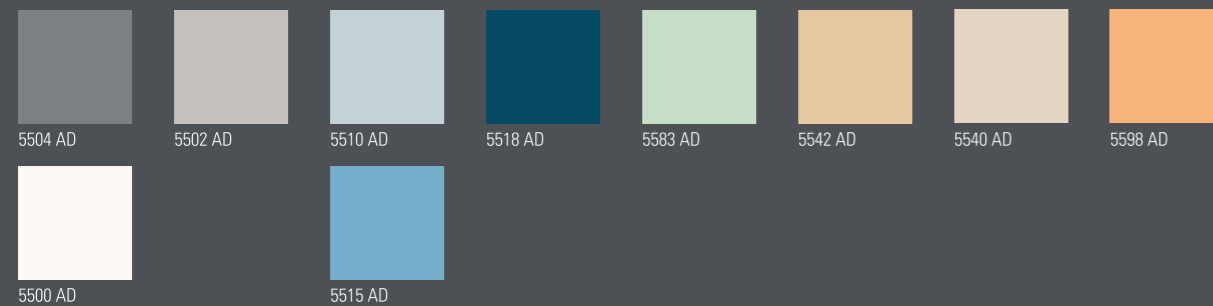

Este tipo de produto é requerido por razões de segurança e prevenção de acidente especialmente em áreas cuja função exija uma superfície resistente à derrapância. É indicado para condições húmidas e molhadas, em espaços públicos ou habitacionais. Recomendado para áreas de chuveiros e banheiros.

This product type is a requirement for areas where safety is of major importance. It provides an anti-slip surface which helps to prevent accidents. Recommended for humid or wet areas in public or residential areas: for example shower areas and dressing rooms.

Ce type de produit est requis pour des raisons de sécurité et prévention d'accidents, spécialement dans des endroits dont la fonction exige une surface résistante à l'antidérapance. Il est indiqué dans des conditions humides et mouillées, dans des espaces publics ou logements. Recommandé pour les douches et bains publics.

Dieser Produkttyp ist für Bereiche gedacht, in denen die Sicherheit von großer Bedeutung ist. Es bietet eine rutschfeste Oberfläche, die hilft, Unfälle zu vermeiden. Empfohlen für Feucht- und Nassbereiche in öffentlichen oder privaten Gebäuden, beispielsweise Duschbereiche und Umkleieräume.



Este produto também se encontra disponível em ladrilho de porcelanato vidrado ingelivo acetinado.

This product is also available in Glazed Porcelain.

Ce produit peut être fourni également en grès cérame fin vitrifié ingélif, émaillé, satiné.

Dieser Artikel ist auch als frostsichere, glasiertes Feinsteinzeug in seidenmatt erhältlich.

EN 14411:2012 Annex G Group B1a GL  
ISO 13006:2012 Annex G Group B1a GL  
ANSI A137.1-2012 Class P1 (Impervious - Porcelain)

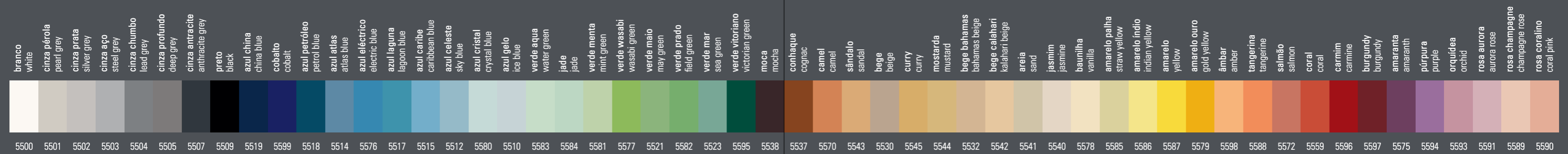

# NovaArquitectura

PEÇAS ESPECIAIS · TRIM PIECES · PIÈCES SPÉCIALES · FORMSTÜCKE

LADRILHOS VIDRADOS INGELIVOS ACETINADOS · SATIN FINISH FROST RESISTANT GLAZED STONEWARE TILES

CARREAUX INGÉLIFS EN GRÈS FIN VITRIFIÉ, ÉMAILLÉ, SATINÉ · FROSTSICHERE, GLASIERTE STEINZEUGFLIESE IN SEIDENMATT

EN 14411: 2012 ANNEX H GROUP BIb GL · ISO 13006:2012 ANNEX H GROUP BIb GL · ANSI A137.1-2012 CLASS P2 (VITREOUS)



Disponível em branco 5500. Para encomenda de outras cores por favor consultar o fabricante. Devido aos diferentes métodos de produção usados nas peças especiais existe a possibilidade de ocorrer ligeiras variações de cor.

Available in white 5500. For more information on other colours please contact manufacturer. Due to the methods used in production of tiles and mouldings, slight variations in colour may occur.

Disponible en blanc 5500. Veuillez consulter le fabricant pour d'autres coloris. De légères variations de couleur sont possibles dû aux différentes méthodes de production utilisées sur ces pièces spéciales.

Erhältlich in Farbe weiß 5500. Sollten Sie diese in einer anderen Farbe benötigen wenden Sie sich bitte an unser Verkaufsteam. Produktionsbedingt können leichte Farbunterschiede bzw. Farbabweichungen auftreten.

Formato · Format	Caixa · Box		
	Pcs. · Stk.	m <sup>2</sup> / ML	kg
3×3AECX	4	-	0,10
3×3AICX	4	-	0,10
3×3AICV	4	-	0,10
3×3AE	4	-	0,10
10×3AE	4	-	0,30
10×3AI	4	-	0,20
15×3AI	4	-	0,40
15×3AE	4	-	0,40
15×3CV	25	-	1,88
15×3CX	25	-	1,88
20×3CV	25	-	2,25
20×3CX	25	-	2,25
10×20RC	10	2,00 ML	3,30
10×20B1G	50	1,00 m <sup>2</sup>	13,50
10×20B1P	50	1,00 m <sup>2</sup>	13,50
10×20B2E	50	1,00 m <sup>2</sup>	13,50
10×20B2D	50	1,00 m <sup>2</sup>	13,50
15×15RC	10	1,50 m <sup>2</sup>	3,30
15×15B1L	44	1,00 m <sup>2</sup>	12,80
20×20B1L	25	1,00 m <sup>2</sup>	12,70
20×20B2L	25	1,00 m <sup>2</sup>	12,70
8×60ROD	20	12,00 ML	21,40

Peças Especiais  
Pièces Spéciales  
Trim Pieces  
Formstücke

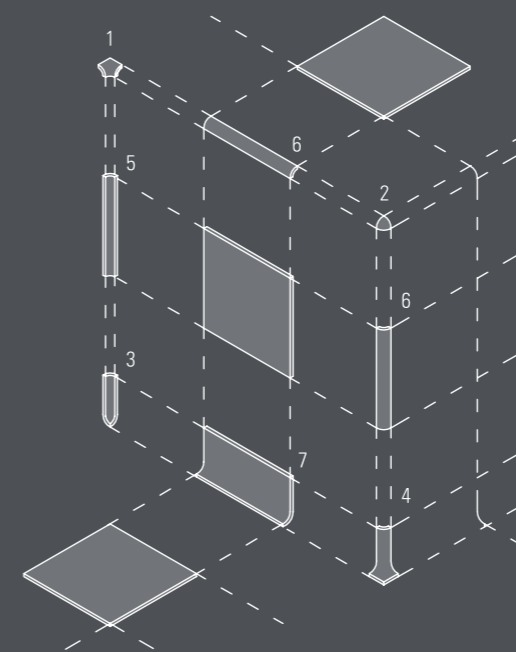
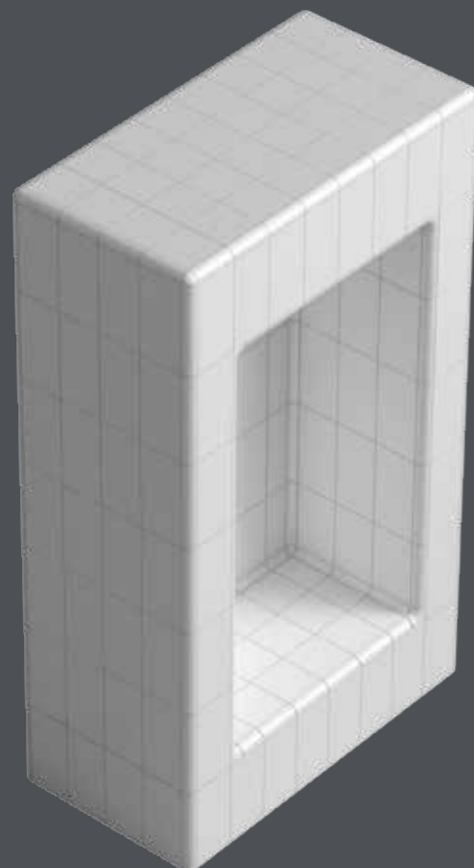
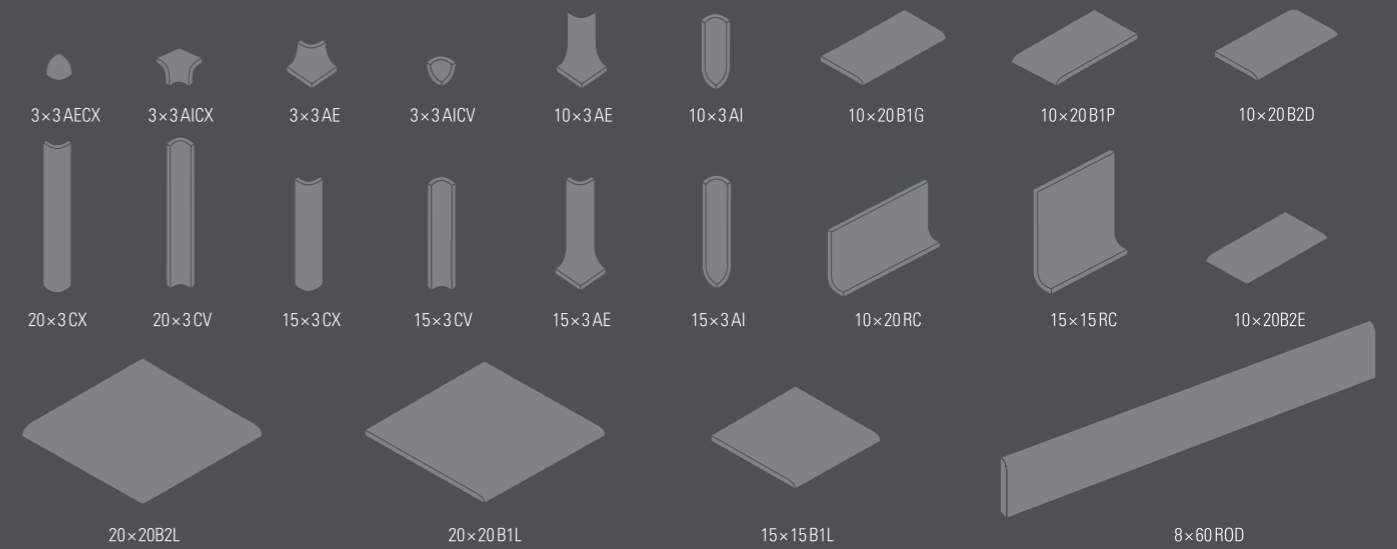

1 - 3×3 AICX · 2 - 3×3 AECX · 3 - 10×3 AI  
4 - 10×3 AE · 5 - 20×3 CV · 6 - 20×3 CX · 7 - 10×20 RC

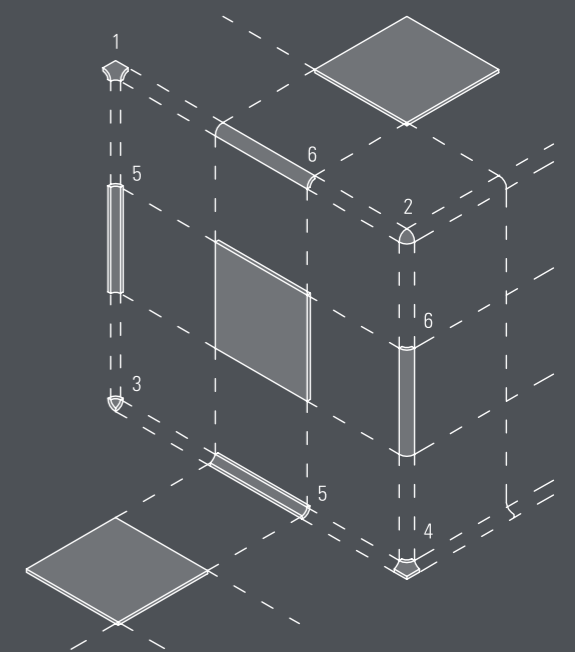

1 - 3×3 AICX · 2 - 3×3 AECX · 3 - 3×3 AICV  
4 - 3×3 AE · 5 - 15×3 CV · 6 - 15×3 CX

# NovaArquitectura

PEÇAS ESPECIAIS ANTIDERRAPANTES · TRIM PIECES WITH ANTI-SLIP FINISH

PIÈCES SPÉCIALES ANTIDÉRAPANTES · TRITTSICHERE FORMSTÜCKE

LADRILHOS VIDRADOS INGELIVOS ACETINADOS · SATIN FINISH FROST RESISTANT GLAZED STONEWARE TILES

CARREAUX INGÉLIFS EN GRÈS FIN VITRIFIÉ, ÉMAILLÉ, SATINÉ · FROSTSICHERE, GLASIERTE STEINZEUGFLIESE IN SEIDENMATT

EN 14411: 2012 ANNEX H GROUP B1b GL · ISO 13006:2012 ANNEX H GROUP B1b GL · ANSI A137.1-2012 CLASS P2 (VITREOUS)



Este tipo de produto é requerido por razões de segurança e prevenção de acidente especialmente em áreas cuja função exija uma superfície resistente à derrapância. É indicado para condições húmidas e molhadas, em espaços públicos ou habitacionais. Recomendado para áreas de chuveiros e balneários.

This product type is a requirement for areas where safety is of major importance. It provides an anti-slip surface which helps to prevent accidents. Recommended for humid or wet areas in public or residential areas: for example shower areas and dressing rooms.

Ce type de produit est requis pour des raisons de sécurité et prévention d'accidents, spécialement dans des endroits dont la fonction exige une surface résistante à l'antidérapance. Il est indiqué dans des conditions humides et mouillées, dans des espaces publiques ou logements. Recommandé pour les douches et bains publics.

Dieser Produkttyp ist für Bereiche gedacht, in denen die Sicherheit von großer Bedeutung ist. Es bietet eine rutschfeste Oberfläche, die hilft, Unfälle zu vermeiden. Empfohlen für Feucht- und Nassbereiche in öffentlichen oder privaten Gebäuden, beispielsweise Duschbereiche und Umkleieräume.



Disponível em branco 5500. Para encomenda de outras cores por favor consultar o fabricante. Devido aos diferentes métodos de produção usados nas peças especiais existe a possibilidade de ocorrer ligeiras variações de cor.

Available in white 5500. For more information on other colours please contact manufacturer. Due to the methods used in production of tiles and mouldings, slight variations in colour may occur.

Disponible en blanc 5500. Veuillez consulter le fabricant pour d'autres coloris. De légères variations de couleur sont possibles dû aux différentes méthodes de production utilisées sur ces pièces spéciales.

Erhältlich in Farbe weiß 5500. Sollten Sie diese in einer anderen Farbe benötigen wenden Sie sich bitte an unser Verkaufsteam. Produktionsbedingt können leichte Farbunterschiede bzw. Farbabweichungen auftreten.

Antiderrapante · Slip-resistant · Antidérapant · Trittsicher

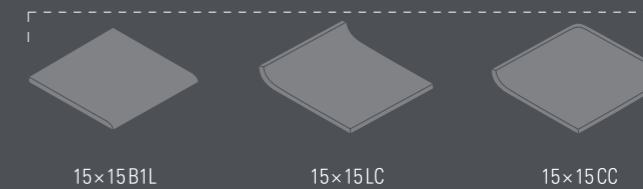

	Formato · Format	Caixa · Box		
		Pcs. · Stk.	m <sup>2</sup>	kg
Peças Especiais	15×15B1L	44	1,00	12,80
Pièces Spéciales	15×15LC	10	1,50	3,30
Trim Pieces	15×15CC	4	-	1,50

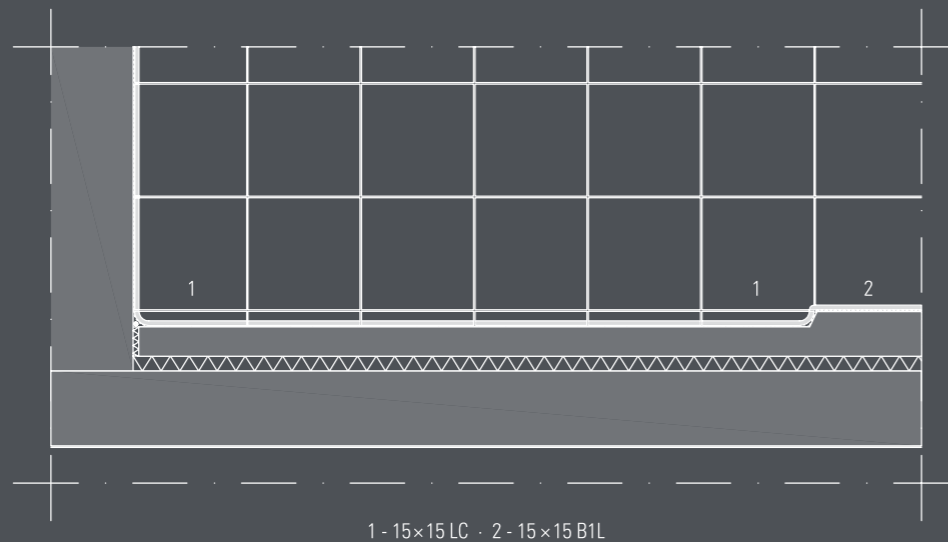

1 - 15×15 LC · 2 - 15×15 B1L

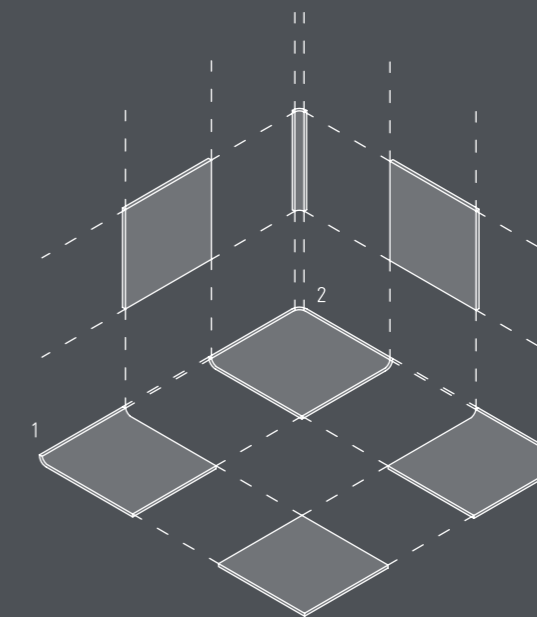

1 - 15×15 LC · 2 - 15×15 CC

# arquitectos

AZULEJOS DE PASTA BRANCA BICOZEDURA BRILHANTE/MATE · GLOSSY/MATT DOUBLE FIRED WHITE BODY WALL TILES  
FAÏENCES EN PÂTE BLANCHE BI-CUISSON BRILLANT/MAT · WEISS-SCHERBIGE ZWEIBRAND STEINGUTFLIESEN GLÄNZEND/MATT

M 20 × 40 cm  
8" × 16"  
W 197 × 397 × 7,5 mm

M 15 × 30 cm  
6" × 12"  
W 147 × 297 × 7,5 mm



APLICAÇÃO · APPLICATION · APPLICATION · VERLEGUNG  
ACABAMENTO · FINISH · FINITION · OBERFLÄCHE

AZULEJOS DE PASTA BRANCA BICOZEDURA  
DOUBLE FIRED WHITE BODY WALL TILES

EN 14411: 2012 ANNEX K GROUP BIII GL  
ISO 13006: 2012 ANNEX L GROUP BIII GL  
ANSI A134.1-2012 CLASS P4 (NON-VITREOUS)

57 CORES  
57 COLOURS

02 ACABAMENTOS  
02 FINISHES

04 FORMATOS  
04 FORMATS

MODULAR  
MODULAR

CTINCA 

M 20 × 20 cm  
8" × 8"  
W 197 × 197 × 7,5 mm

M 15 × 15 cm  
6" × 6"  
W 147 × 147 × 5,8 mm

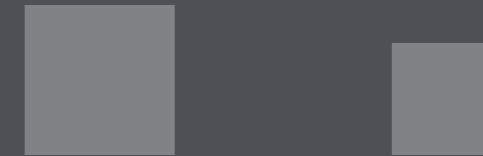

FAÏENCES EN PÂTE BLANCHE BI-CUISSON  
WEISS-SCHERBIGE ZWEIBRAND STEINGUTFLIESEN

EN 14411: 2012 ANNEX K GROUP BIII GL  
ISO 13006: 2012 ANNEX L GROUP BIII GL  
ANSI A134.1-2012 CLASS P4 (NON-VITREOUS)

57 COLORIS  
57 FARBEN

02 FINITIONS  
02 OBERFLÄCHEN

04 FORMATS  
04 FORMATE

MODULAIRE  
MODUL



# arquitectos

AZULEJOS DE PASTA BRANCA BICOZEDURA BRILHANTE · GLOSSY DOUBLE FIRED WHITE BODY WALL TILES  
 FAÏENCES EN PÂTE BLANCHE BI-CUISSON BRILLANT · WEISS-SCHERBIGE ZWEIBRAND STEINGUTFLIESEN GLÄNZEND  
 EN 14411: 2012 ANNEX K GROUP BIII GL · ISO 13006: 2012 ANNEX L GROUP BIII GL · ANSI A134.1-2012 CLASS P4 (NON-VITREOUS)



Todos os artigos com a referência sublinhada estão disponíveis em pavimento coordenado (consultar pág. 6 a 19).  
 All items where the product code is underlined have a matching floor tile (see pages 6 to 19).  
 Tous les articles soulignés disposent d'un sol coordonné (consulter de la page 6 à la 19).  
 Die unterstrichenen Artikelnummern sind auch als kombinierbare Bodenfliesen erhältlich (siehe Seite 6 bis 19).

arquitectos	
REF Brancos · Whites · Blancs · Weiss	
M 20×20 cm	2200 = 0350
M 15×15 cm	2200 = 0001/147

Formato · Format	Caixa · Box			Paleta · Pallet					
	Pcs. · Stk.	m <sup>2</sup>	kg	Caixa / Paleta Box / Pallet	m <sup>2</sup>	Net. kg	Brut. kg	cm	
Revestimento · Wall Tiles Faïences · Wandfliese	M 20×20×0,75 cm M 15×15×0,58 cm	25 66	1,00 1,50	12,00 13,97	96 70	96,00 105,00	1.152 978	1.177 1.003	120×80×95 120×80×90

02 FORMATOS · 02 FORMATS  
 02 FORMATS · 02 FORMATE

M 20×20 cm  
 8"×8"  
 W 197×197×7,5 mm

M 15×15 cm  
 6"×6"  
 W 147×147×5,8 mm

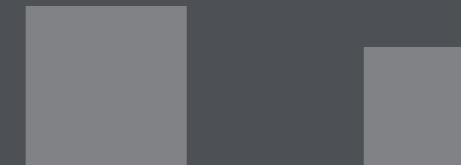

57 CORES · 57 COLOURS  
 57 COLORIS · 57 FARBEN

Cores disponíveis em stock · Colours available in stock  
 Coloris disponibles en stock · Farben sind Lagerware

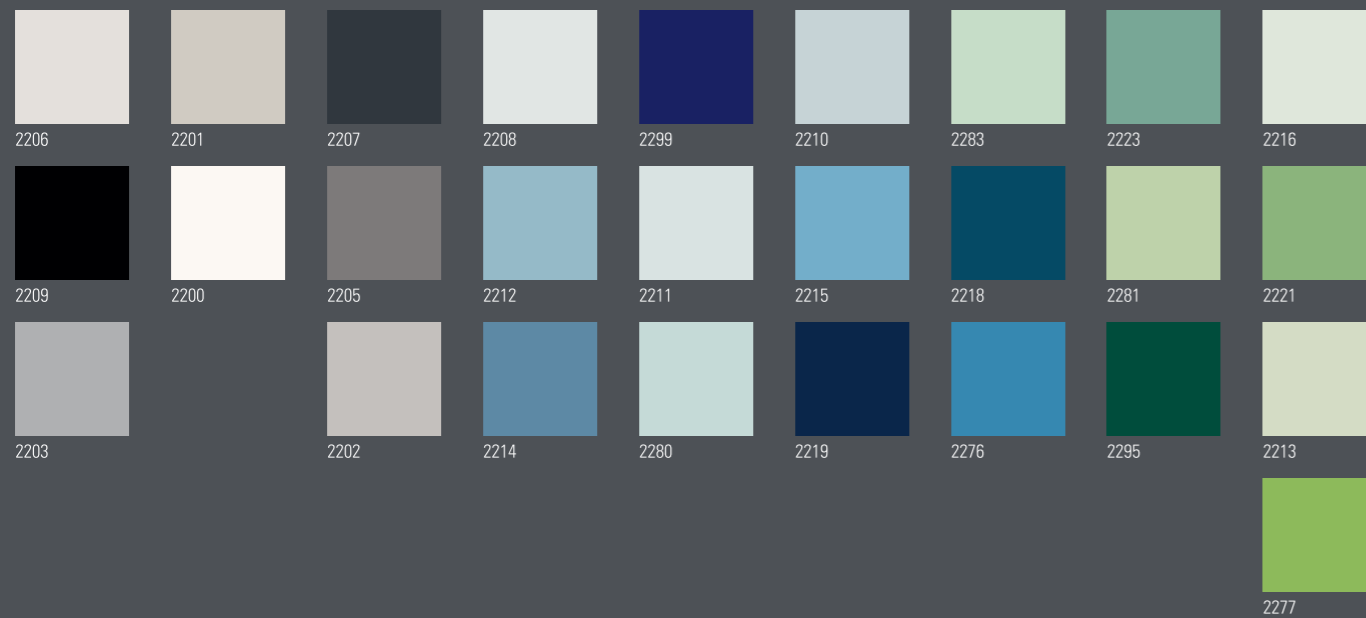

branco white  
 cinza nuvem cloud grey  
 cinza pérola pearl grey  
 cinza prata silver grey  
 cinza aço steel grey  
 cinza profundo deep grey  
 cinza antracite anthracite grey  
 preto black  
 azul china china blue  
 cobalto cobalt  
 azul petróleo petrol blue  
 azul atlas atlas blue  
 azul eléctrico electric blue  
 azul caribe caribbean blue  
 azul celeste sky blue  
 azul cristal crystal blue  
 azul gelo ice blue  
 azul horizonte horizon blue  
 azul azul  
 verde oceano ocean green  
 verde arcádia arcadia green  
 verde aqua water green  
 verde menta mint green  
 verde wasabi wasabi green  
 verde malo may green  
 verde mar sea green  
 verde victoriano victorian green  
 mocha mocha

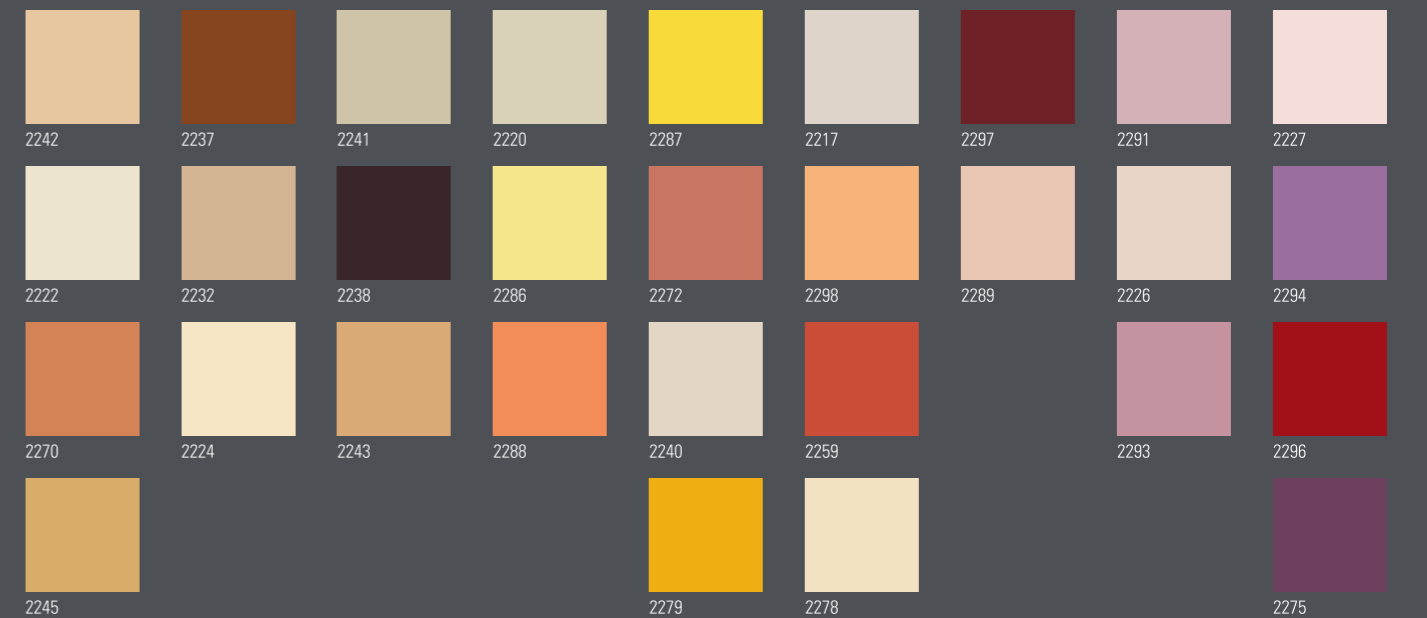

conhaque cognac  
 camel camel  
 sândalo sandal  
 curry curry  
 bege bahamas bahamas beige  
 bege calahari kalahari beige  
 areia sand  
 marfim ivory  
 pérola pearl  
 creme cream  
 jasmim jasmine  
 frésia freesia  
 baunilha vanilla  
 amarelo índio indian yellow  
 amarelo yellow  
 amarelo ouro gold yellow  
 âmbar amber  
 tangerina tangerine  
 salmão salmon  
 coral coral  
 carmim carmine  
 burgundy burgundy  
 amarantha amaranth  
 púrpura purple  
 orquídea orchid  
 rosa aurora aurora rose  
 rosa pétala petal rose  
 rosa baby baby pink  
 rosa champagne champagne rose

# arquitectos

AZULEJOS DE PASTA BRANCA BICOZEDURA MATE · MATT DOUBLE FIRED WHITE BODY WALL TILES  
 FAÏENCES EN PÂTE BLANCHE BI-CUISSON MAT · WEISS-SCHERBIGE ZWEIBRAND STEINGUTFLIESEN MATT  
 EN 14411: 2012 ANNEX K GROUP BIII GL · ISO 13006: 2012 ANNEX L GROUP BIII GL · ANSI A134.1-2012 CLASS P4 (NON-VITREOUS)



Todos os artigos com a referência sublinhada estão disponíveis em pavimento coordenado (consultar pág. 6 a 19).  
 All items where the product code is underlined have a matching floor tile (see pages 6 to 19).  
 Tous les articles soulignés disposent d'un sol coordonné (consulter de la page 6 à la 19).  
 Die unterstrichenen Artikelnummern sind auch als kombinierbare Bodenfliesen erhältlich (siehe Seite 6 bis 19).

arquitectos	
REF Brancos · Whites · Blancs · Weiss	
M 20×20 cm	2300 = 0351
M 15×15 cm	2300 = 0151/147

Formato · Format	Caixa · Box			Paleta · Pallet					
	Pcs. · Stk.	m <sup>2</sup>	kg	Caixa / Paleta Box / Pallet	m <sup>2</sup>	Net. kg	Brut. kg	cm	
Revestimento · Wall Tiles Faïences · Wandfliese	M 20×20×0,75 cm M 15×15×0,58 cm	25 66	1,00 1,50	12,00 13,97	96 70	96,00 105,00	1.152 978	1.177 1.003	120×80×95 120×80×90

02 FORMATOS · 02 FORMATS  
 02 FORMATS · 02 FORMATE

M 20×20 cm  
 8"×8"  
 W 197×197×7,5 mm

M 15×15 cm  
 6"×6"  
 W 147×147×5,8 mm



50 CORES · 50 COLOURS  
 50 COLORIS · 50 FARBEN

Cores disponíveis em stock · Colours available in stock  
 Coloris disponibles en stock · Farben sind Lagerware

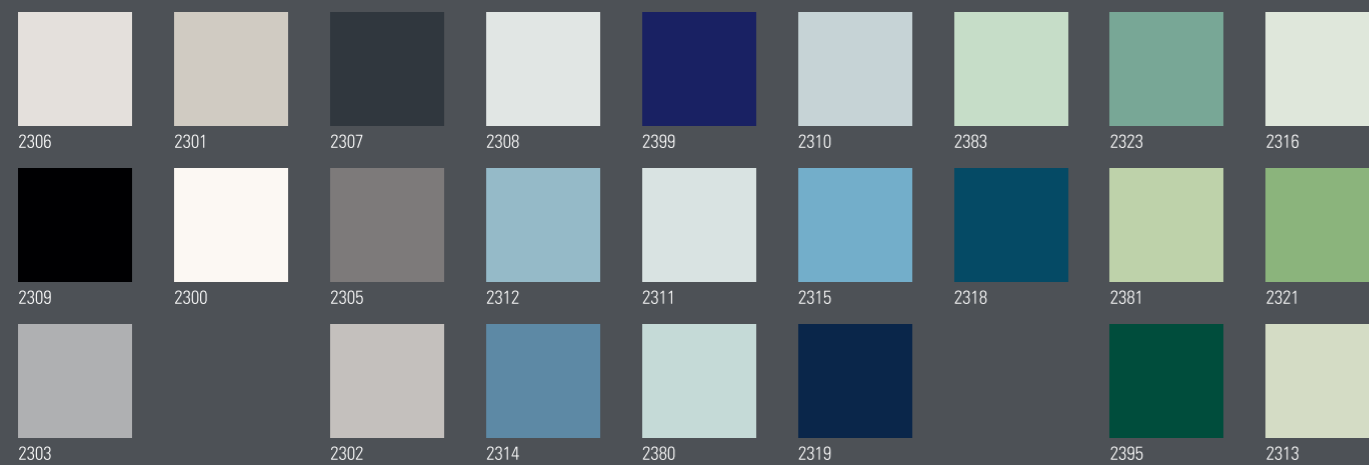

- branco white
- cinza nuvem cloud grey
- cinza pérola pearl grey
- cinza prata silver grey
- cinza aço steel grey
- cinza profundo deep grey
- cinza antracite anthracite grey
- preto black
- azul china china blue
- cobalto cobalt
- azul petróleo petrol blue
- azul atlas atlas blue
- azul eléctrico electric blue
- azul caribe caribbean blue
- azul celeste sky blue
- azul cristal crystal blue
- azul gelo ice blue
- azul horizonte horizon blue
- azul azul
- verde oceano ocean green
- verde arcádia arcadia green
- verde aqua water green
- verde menta mint green
- verde wasabi wasabi green
- verde malo may green
- verde mar sea green
- verde victoriano victorian green
- mocha

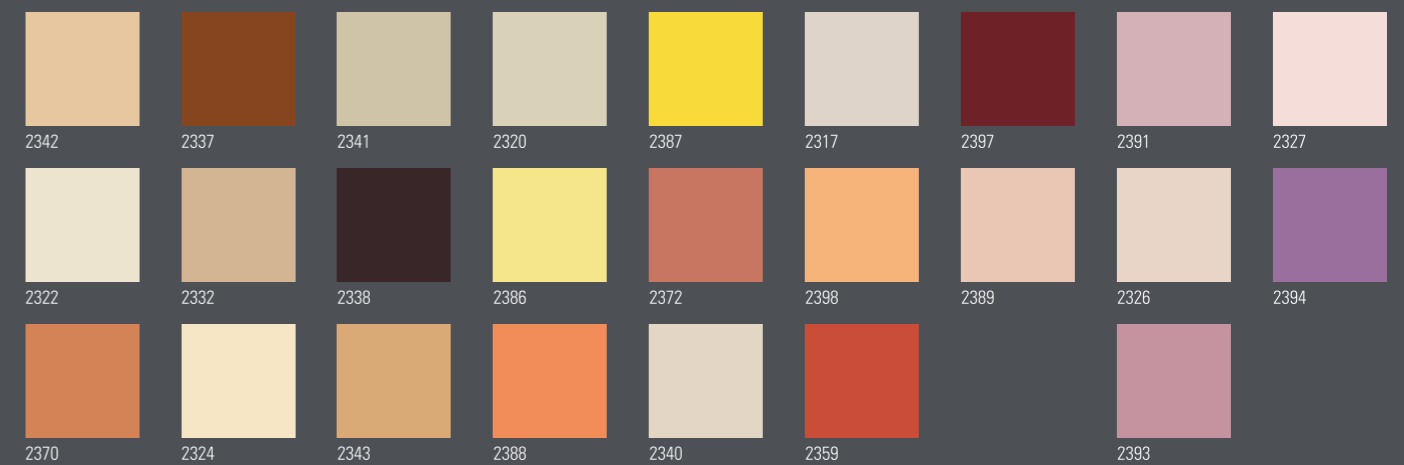

- conhaque cognac
- camel camel
- sândalo sandal
- curry curry
- bege bahamas bahamas beige
- bege calahari kalahari beige
- areia sand
- marfim ivory
- pérola pearl
- creme cream
- jasmin jasmine
- frésia freesia
- baunilha vanilla
- amarelo índio indian yellow
- amarelo yellow
- amarelo ouro gold yellow
- âmbar amber
- tangerina tangerine
- salimão salmon
- coral coral
- carmin carmine
- burgundy burgundy
- amaranta amarant
- púrpura purple
- orquídea orchid
- rosa aurora aurore rose
- rosa pétala petal rose
- rosa baby baby pink
- rosa champagne champagne rose



# arquitectos

AZULEJOS DE PASTA BRANCA BICOZEDURA BRILHANTE · GLOSSY DOUBLE FIRED WHITE BODY WALL TILES  
 FAÏENCES EN PÂTE BLANCHE BI-CUISSON BRILLANT · WEISS-SCHERBIGE ZWEIBRAND STEINGUTFLIESEN GLÄNZEND  
 EN 14411: 2012 ANNEX K GROUP BIII GL · ISO 13006: 2012 ANNEX L GROUP BIII GL · ANSI A134.1-2012 CLASS P4 (NON-VITREOUS)



Todos os artigos com a referência sublinhada estão disponíveis em pavimento coordenado (consultar pág. 6 a 19).

All items where the product code is underlined have a matching floor tile (see pages 6 to 19).

Tous les articles soulignés disposent d'un sol coordonné (consulter de la page 6 à la 19).

Die unterstrichenen Artikelnummern sind auch als kombinierbare Bodenfliesen erhältlich (siehe Seite 6 bis 19).

<b>arquitectos</b>	
REF. Brancos · Whites · Blancs · Weiss	
M 20×40 cm	2200 = 0350
M 15×30 cm	

Formato · Format	Caixa · Box			Paleta · Pallet					
	Pcs. · Stk.	m <sup>2</sup>	kg	Caixa / Paleta Box / Pallet	m <sup>2</sup>	Net. kg	Brut. kg	cm	
Revestimento · Wall Tiles Faïences · Wandfliese	M 20×40×0,75 cm M 15×30×0,75 cm	25 26	2,00 1,17	24,00 14,48	48 70	96,00 81,90	1.152 1.014	1.177 1.039	120×80×96 120×80×91

02 FORMATOS · 02 FORMATS  
02 FORMATS · 02 FORMATE

M 20×40 cm  
8"×16"  
W 197×397×7,5mm

M 15×30 cm  
6"×12"  
W 147×297×7,5mm

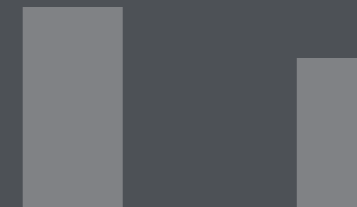

31 CORES · 31 COLOURS  
31 COLORIS · 31 FARBEN

Cores disponíveis em stock · Colours available in stock  
Coloris disponibles en stock · Farben sind Lagerware

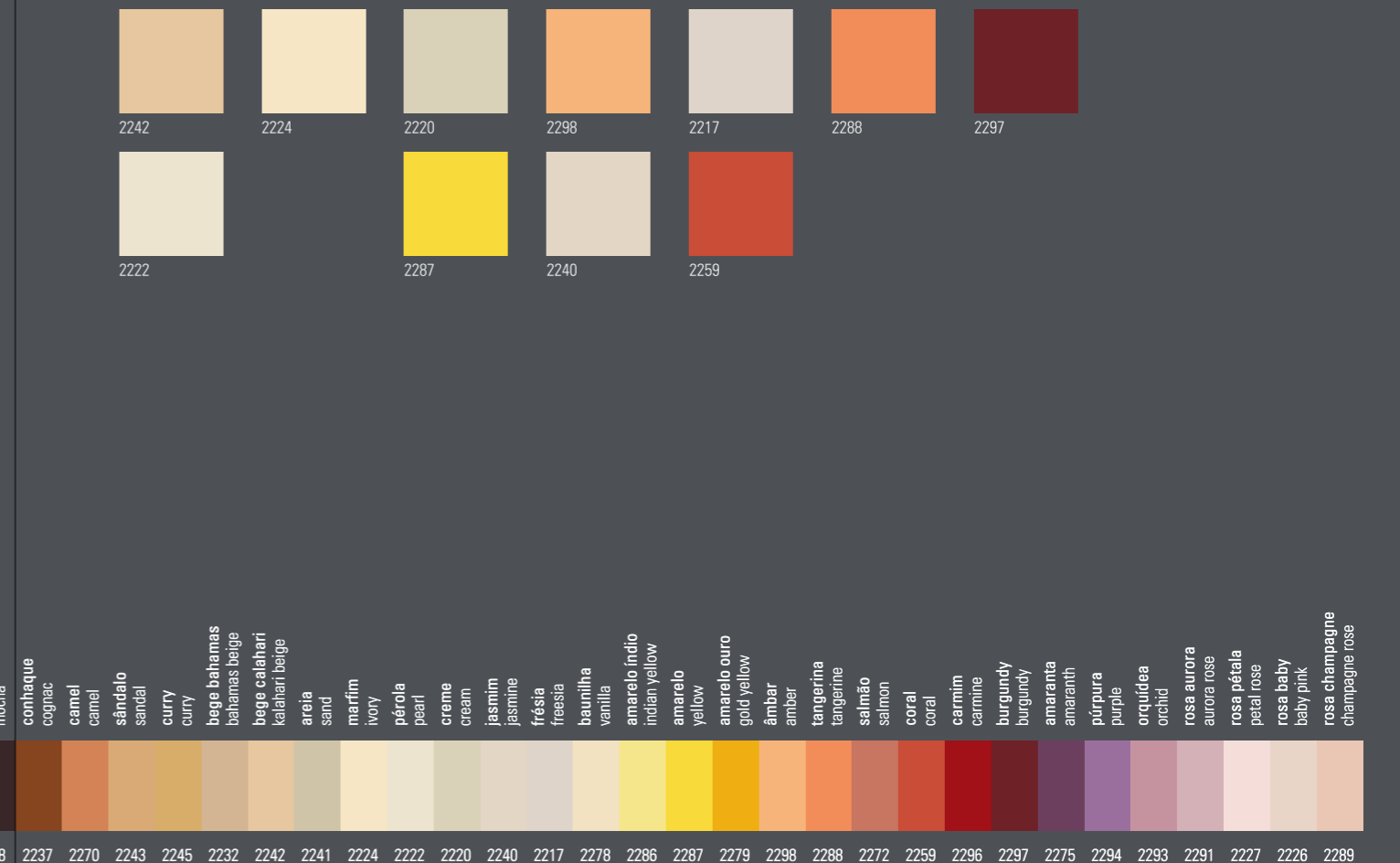
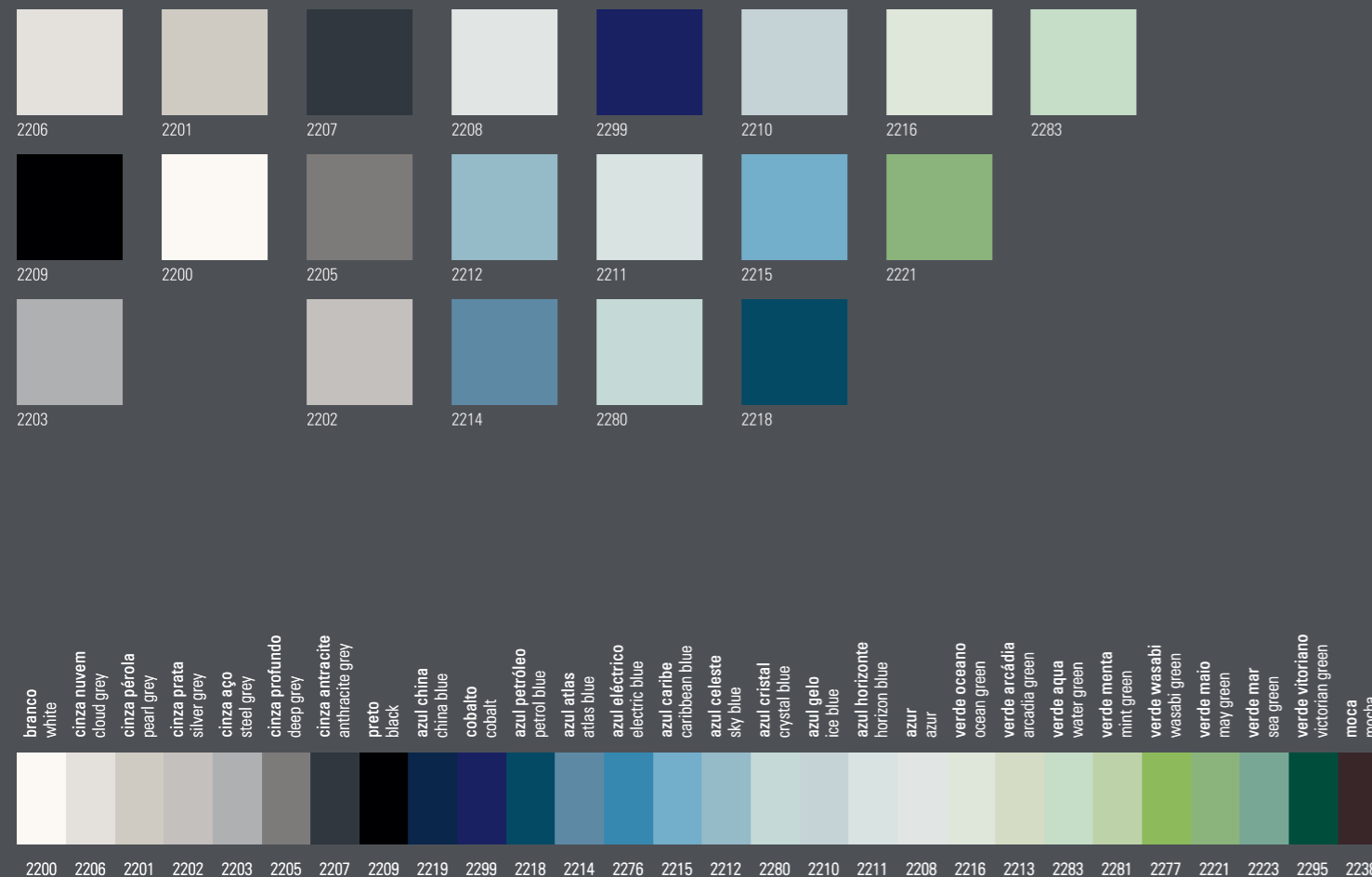

# arquitectos

AZULEJOS DE PASTA BRANCA BICOZEDURA MATE · MATT DOUBLE FIRED WHITE BODY WALL TILES  
 FAÏENCES EN PÂTE BLANCHE BI-CUISSON MAT · WEISS-SCHERBIGE ZWEIBRAND STEINGUTFLIESEN MATT  
 EN 14411: 2012 ANNEX K GROUP BIII GL · ISO 13006: 2012 ANNEX L GROUP BIII GL · ANSI A134.1-2012 CLASS P4 (NON-VITREOUS)



Todos os artigos com a referência sublinhada estão disponíveis em pavimento coordenado (consultar pág. 6 a 19).

All items where the product code is underlined have a matching floor tile (see pages 6 to 19).

Tous les articles soulignés disposent d'un sol coordonné (consulter de la page 6 à la 19).

Die unterstrichenen Artikelnummern sind auch als kombinierbare Bodenfliesen erhältlich (siehe Seite 6 bis 19).

<b>arquitectos</b>	
REF. Brancos · Whites · Blancs · Weiss	
M 20×40 cm	2300 = 0351
M 15×30 cm	

Formato · Format	Caixa · Box			Paleta · Pallet					
	Pcs. · Stk.	m <sup>2</sup>	kg	Caixa / Paleta Box / Pallet	m <sup>2</sup>	Net. kg	Brut. kg	cm	
Revestimento · Wall Tiles Faïences · Wandfliese	M 20×40×0,75 cm M 15×30×0,75 cm	25 26	2,00 1,17	24,00 14,48	48 70	96,00 81,90	1.152 1.014	1.177 1.039	120×80×96 120×80×91

02 FORMATOS · 02 FORMATS  
02 FORMATS · 02 FORMATE

M 20×40 cm  
8"×16"  
W 197×397×7,5 mm

M 15×30 cm  
6"×12"  
W 147×297×7,5 mm



31 CORES · 31 COLOURS  
31 COLORIS · 31 FARBEN

Cores disponíveis em stock · Colours available in stock  
Coloris disponibles en stock · Farben sind Lagerware

2306 2301 2307 2308 2399 2310 2316 2383

2309 2300 2305 2312 2311 2315 2321

2303 2302 2314 2380 2318

branco white  
cinza nuvem cloud grey  
cinza pérola pearl grey  
cinza prata silver grey  
cinza aço steel grey  
cinza profundo deep grey  
cinza antracite anthracite grey  
preto black  
azul china china blue  
cobalto cobalt  
azul petróleo petrol blue  
azul atlas atlas blue  
azul eléctrico electric blue  
azul caribe caribbean blue  
azul celeste sky blue  
azul cristal crystal blue  
azul gelo ice blue  
azul horizonte horizon blue  
azul azul  
verde oceano ocean green  
verde arcádia arcadia green  
verde aqua water green  
verde menta mint green  
verde wasabi wasabi green  
verde malva may green  
verde mar sea green  
verde victoriano victorian green  
moca mocha

2300 2306 2301 2302 2303 2305 2307 2309 2319 2399 2318 2314 ---- 2315 2312 2380 2310 2311 2308 2316 2313 2383 2381 ---- 2321 2323 2395 2338

2342 2324 2320 2398 2317 2388 2397

2322 2387 2340 2359

conhaque cognac  
camel camel  
sândalo sandal  
curry curry  
bege bahamas bahamas beige  
bege calahari kalahari beige  
areia sand  
marfim ivory  
pérola pearl  
creme cream  
jasmim jasmine  
frésia freesia  
baunilha vanilla  
amarelo índio indian yellow  
amarelo yellow  
amarelo ouro gold yellow  
âmbar amber  
tangerina tangerine  
salmão salmon  
coral coral  
carmim carmine  
burgundy burgundy  
amaranta amarant  
púrpura purple  
orquídea orchid  
rosa aurora  
rosa pétala petal rose  
rosa baby baby pink  
rosa champagne champagne rose

2337 2370 2343 ---- 2332 2342 2341 2324 2322 2320 2340 2317 ---- 2386 2387 ---- 2398 2388 2372 2359 ---- 2397 ---- 2394 2393 2391 2327 2326 2389

# arquitectos

PEÇAS ESPECIAIS · TRIM PIECES · PIÈCES SPÉCIALES · FORMSTÜCKE

AZULEJOS DE PASTA BRANCA BICOZEDURA BRILHANTE/MATE · GLOSSY/MATT DOUBLE FIRED WHITE BODY WALL TILES

FAÏENCE EN PÂTE BLANCHE BI-CUISSON BRILLANT/MAT · WEISS-SCHERBIGE ZWEIBRAND STEINGUTFLIESEN GLÄNZEND/MATT

EN 14411: 2012 ANNEX K GROUP BIII GL · ISO 13006: 2012 ANNEX L GROUP BIII GL · ANSI A134.1-2012 CLASS P4 (NON-VITREOUS)



Disponível em branco brilhante 2200 e mate 2300. Para encomenda de outras cores por favor consultar o fabricante. Devido aos diferentes métodos de produção usados nas peças especiais existe a possibilidade de ocorrer ligeiras variações de cor.

Available in glossy white 2200 and in matt white 2300. For more information on other colours please call us. Due to the methods used in production of tiles and mouldings, slight variations in colour may occur.

Disponible en blanc brillant 2200 et mat 2300. Veuillez consulter le fabricant pour d'autres coloris. De légères variations de couleur sont possibles dû aux différentes méthodes de production utilisées sur ces pièces spéciales.

Erhältlich in Farbe weiß glänzend 2200 und matt 2300. Sollten Sie diese in einer anderen Farbe benötigen wenden Sie sich bitte an unser Verkaufsteam. Produktionsbedingt können leichte Farbunterschiede bzw. Farbabweichungen auftreten.

	Formato · Format	Caixa · Box 	
		Pcs. · Stk.	kg
<b>Peças Especiais</b>	3,5×3,5AECX	4	0,07
	3,5×3,5AICV	4	0,07
Pièces Spéciales	15×3,5CV	22	1,89
Trim Pieces	15×3,5CX	22	1,89
Formstücke	20×3,5CV	12	1,41
	20×3,5CX	12	1,41

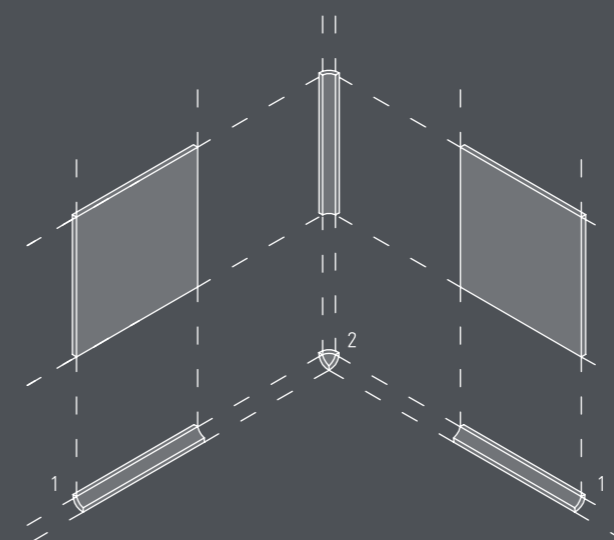
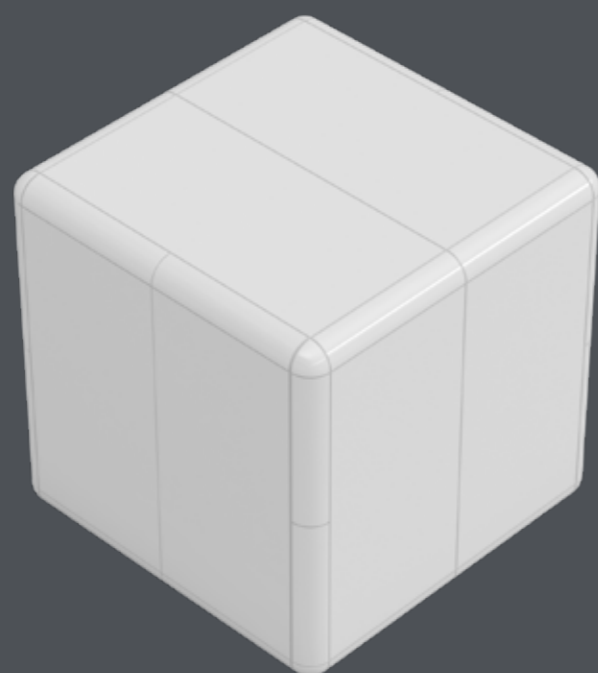

1 - 15×3,5 CV · 2 - 3,5×3,5 AICV

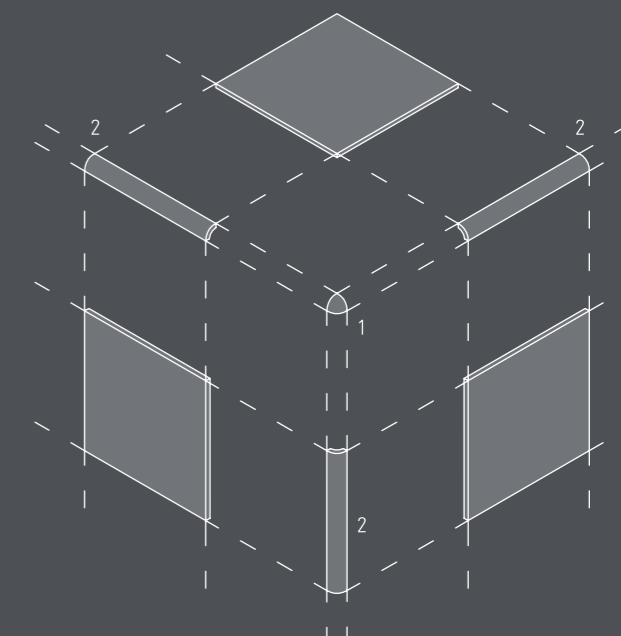

1 - 3,5×3,5 AECX · 2 - 15×3,5 CX



# NovaArquitectura & arquitectos

PIANO LISTÉIS · BORDERS · LISTELS · BORDÜREN

AZULEJOS DE PASTA BRANCA BICOZEDURA BRILHANTE · GLOSSY DOUBLE FIRED WHITE BODY WALL TILES  
 FAÏENCES EN PÂTE BLANCHE BI-CUISSON BRILLANT · WEISS-SCHERBIGE ZWEIBRAND STEINGUTFLIESEN GLÄNZEND

02 FORMATOS · 02 FORMATS

02 FORMATS · 02 FORMATE

M3×20 cm  
 1"×8"

W 27×197×7,5mm

M3×15 cm  
 1"×6"

W 27×147×5,8mm



APLICAÇÃO · APPLICATION · APPLICATION · VERLEGUNG  
 ACABAMENTO · FINISH · FINITION · OBERFLÄCHE



AZULEJOS DE PASTA BRANCA BICOZEDURA · DOUBLE FIRED WHITE BODY WALL TILES  
 FAÏENCES EN PÂTE BLANCHE BI-CUISSON · WEISS-SCHERBIGE ZWEIBRAND STEINGUT

EN 14411: 2012 ANNEX K GROUP BIII GL  
 ISO 13006: 2012 ANNEX L GROUP BIII GL  
 ANSI A134.1-2012 CLASS P4 (NON-VITREOUS)

21 CORES · 21 COLOURS  
 21 COLORIS · 21 FARBEN

BRILHANTE · GLOSSY  
 BRILLANT · GLÄNZEND

02 FORMATOS · 02 FORMATS  
 02 FORMATS · 02 FORMATE

MODULAR · MODULAR  
 MODULAIRE · MODUL

# NovaArquitectura & arquitectos

PIANO LISTÉIS · BORDERS · LISTELS · BORDÜREN

AZULEJOS DE PASTA BRANCA BICOZEDURA BRILHANTE · GLOSSY DOUBLE FIRED WHITE BODY WALL TILES

FAÏENCES EN PÂTE BLANCHE BI-CUISSON BRILLANT · WEISS-SCHERBIGE ZWEIBRAND STEINGUTFLIESEN GLÄNZEND

EN 14411: 2012 ANNEX K GROUP BIII GL · ISO 13006: 2012 ANNEX L GROUP BIII GL · ANSI A134.1-2012 CLASS P4 (NON-VITREOUS)



M3×20 cm = 0300/ref.

M3×15 cm = 0200/ref.

CINCA

02 FORMATOS · 02 FORMATS

02 FORMATS · 02 FORMATE

M3×20 cm  
1"×8"  
W 27×197×7,5 mm

M3×15 cm  
1"×6"  
W 27×147×5,8 mm

	Formato · Format	Caixa · Box		
		Pcs. · Stk.	ML	kg
Listéis · Listels	M3×20×0,75 cm	30	6,00	1,92
Borders · Bordüren	M3×15×0,58 cm	40	6,00	1,61



21 CORES · 21 COLOURS

21 COLORIS · 21 FARBEN

Cores disponíveis em stock · Colours available in stock

Coloris disponibles en stock · Farben sind Lagerware

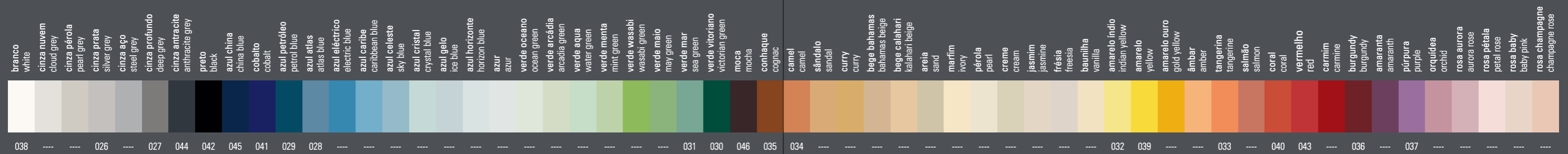
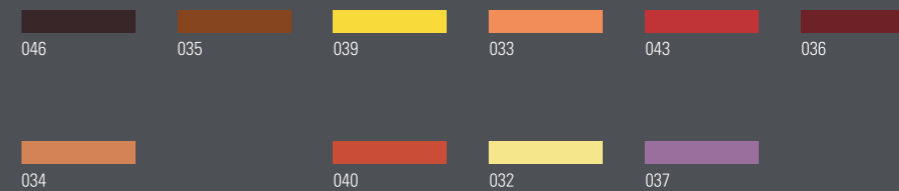
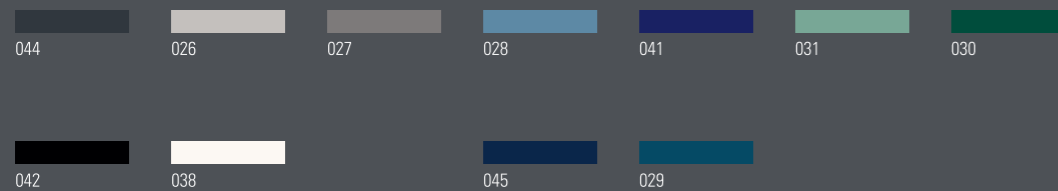



CARACTERÍSTICAS TÉCNICAS · TECHNICAL DATA  
CARACTERISTIQUES TECHNIQUES · TECHNISCHE DATEN

Table with 7 columns: Característica / Caractéristique, Norma, EN, CINCA, EN, CINCA. It lists various technical specifications for tiles, including water absorption, modulus of rupture, abrasion resistance, thermal shock, frost, impact, fire, and chemical resistance.

CARACTERÍSTICAS TÉCNICAS · TECHNICAL DATA  
CARACTERISTIQUES TECHNIQUES · TECHNISCHE DATEN

Table with 7 columns: Característica / Caractéristique, Norma, EN, CINCA, EN, CINCA. It includes detailed specifications for surface quality, deviation from dimensions, thickness, edge straightness, and planarity, along with icons representing each property.

Table with 4 columns: Característica / Caractéristique, DIN, EN, DIN. It details slip resistance (R10-R11) and provides specific data for different tile types like wall tiles and floor tiles.

(1) Consultar o fabricante / Consulter le fabricant / Please contact manufacturer / Hersteller kontaktieren. (2) Os ladrilhos cerâmicos não contribuem para o fogo e são considerados materiais da Classe A1 (CWT Decisão 96/603/CE) / Les carreaux en céramique ne brûlent pas et sont Classe A1 (CWT Decisión 96/603/CE) / Ceramic tiles does not contribute to fire and are considered a Class A1 material (CWT Decisión 96/603/CE) / Die Keramikfliesen sind nicht Brand fördernd und werden als Material der Klasse A1 eingestuft (CWT Entscheidung 96/603/CE). (3) Quando os produtos se destinem a ser usados em locais onde ocorre a preparação de alimentos e onde estejam em contacto directo com a superfície vitrificada, valores indicativos que podem ser alterados sem aviso prévio / Pour produits destinés à être utilisés dans des zones de préparation de produits alimentaires et où ceux-ci sont en contact direct avec la surface émaillée, valeurs indicatives qui peuvent être changées sans avis préalable / Only when intended to use in places where food preparation takes place and food may be in direct contact with the glazed surface of the tile, indicative figures subject to changes without further notice / Falls die Produkte dafür bestimmt sind, auf Arbeitstischen oder Wänden benutzt zu werden, in Räumen in denen Lebensmittel verarbeitet werden und diese in direktem Kontakt zur Glasierung kommen. Es handelt sich hierbei um Richtwerte, die ohne Vorankündigung geändert werden können. (4) Para outras substâncias perigosas, apenas serão realizados ensaios a pedido do cliente, quando relevante considerando regulamentos europeus ou leis, regulamentos ou províncias administrativas / Pour autres substances dangereuses, les tests seront seulement réalisés sur demande du client, s'ils s'avèrent pertinents face aux réglementations européennes ou face aux lois, règlements et dispositions administratives / For other dangerous substances, tests will only be conducted when relevant and requested from customers, considering european regulations or national laws, regulations or administrative provisions / Für andere gefährliche Substanzen werden die Prüfungen nur auf Kundenwunsch durchgeführt, falls relevant, und unter Beachtung der europäischen Vorschriften oder Gesetze, Verordnungen oder Verwaltungsvorschriften. Contatar a CINCA para mais informações / Contacter CINCA pour plus d'informations / Please contact CINCA for more informations / Für weitere Informationen bitte CINCA kontaktieren.

ANSO / ANS / DISCLAIMER / WAARNING: Especificações sujeitas a alterações sem aviso prévio. A presente informação é fornecida sem qualquer garantia adicional de adequação à qualquer uso específico. In nenhum caso a CINCA poderá ser responsabilizada por qualquer dano direto, indireto ou consequente decorrente de, ou de qualquer forma relacionado com, o uso dos seus produtos / Spécifications soumises à modifications sans avis préalable. La présente information est fournie sans aucune garantie supplémentaire d'adaptation à n'importe quelle utilisation spécifique. En aucun cas CINCA ne pourra être responsable pour n'importe quel dégat direct, indirect, résultant ou lié à l'utilisation de ses produits / Specifications subject to change without further notice. This information is issued as is and without any further warranty of fitness for a particular purpose, so in no event shall CINCA be liable for any direct, indirect, or consequential damage whatsoever arising out of or in any way related to the use of their product / Angaben können ohne Bekanntgabe geändert werden. Diese Informationen werden ohne jegliche Gewährleistung der Eignung für einen bestimmten Zweck zur Verfügung gestellt. In keinem Fall darf CINCA haftbar gemacht werden für direkte, indirekte oder in jeglicher Form stehenden Zusammenhang mit Schäden oder Folgeschäden durch die Verwendung seiner Produkte.

CARACTERÍSTICAS TÉCNICAS · TECHNICAL DATA  
CARACTERISTIQUES TECHNIQUES · TECHNISCHE DATEN

Table with 8 columns: Formato - Format, Caixa - Box, Paleta - Pallet. It lists dimensions, quantities, and weights for various tile formats such as M60x60, M30x30, M10x10, and M20x20, including special pieces and revestimento options.

Copyright Cinca (P) 02 / 2015 - Developed by the Cinca Marketing Department - Printed by Glacia AG



Certificação ISO 14001 do Sistema de Gestão do Ambiente implementado na Concepção, Desenvolvimento, Produção e Comercialização de Pavimentos e Revestimentos Cerâmicos Environment Management System ISO 14001 Certification Implemented in the Design, Development, Production and Trading of Ceramic Floor and Wall Tiles

Certificação ISO 9001 do Sistema de Gestão da Qualidade implementado na Concepção, Desenvolvimento, Produção e Comercialização de Pavimentos e Revestimentos Cerâmicos Quality Management System ISO 9001 Certification Implemented in the Design, Development, Production and Trading of Ceramic Floor and Wall Tiles

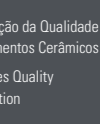
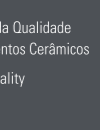

CERAMICS Portugal does it better

NCS - Natural Colour System® property of and used on licence from NCS Colour AB, Stockholm 2012. The colours might not exactly match original NCS colour samples.

**CINCA S.A.**

Rua Principal, 39 | Apartado 12  
P 4509-908 Fiães VFR Portugal  
Tel.: 227 476 400  
Fax: 227 476 488  
Email: [cinca@cinca.pt](mailto:cinca@cinca.pt)

**Export Department**

Rua Principal, 39 | Apartado 12  
P 4509-908 Fiães VFR Portugal  
Tel.: +351 227 476 462  
Fax: +351 227 476 494/5  
Email: [internacional@cinca.pt](mailto:internacional@cinca.pt)

**Serviços Comerciais Portugal**

Rua Principal, 39 | Apartado 12  
P 4509-908 Fiães VFR Portugal  
Tel.: 227 476 404  
Fax: 227 476 490  
Email: [portugal@cinca.pt](mailto:portugal@cinca.pt)

**Showroom Lisboa**

Rua Abranches Ferrão, 3B  
P 1600-296 Lisboa Portugal  
Tel.: 217 210 620  
Fax: 217 210 629

**Showroom Porto**

Edifício Mota Galiza  
Rua Calouste Gulbenkian, 161  
P 4050-145 Porto Portugal  
Tel.: 227 476 489  
Fax: 226 062 502

[www.cinca.pt](http://www.cinca.pt)

