



Engineering progress
Enhancing lives

REHAU PING™

Push In. Connect.

Technical Product Book.



Same Pipe Faster Installation



It's REHAU

PINC™ is push-fit technology for faster installation, while also having the high quality, safety and reliability of REHAU.

It has been designed and manufactured to the highest specifications, and is the result of decades of polymer product development.

We understand plumbing is also changing with customers wanting simpler installs, better productivity, more potential to grow profit and opportunities to save time.

The PINC™ product range satisfies these needs by bringing efficiency and ease to any plumbing project. The PINC™ fitting system also complements REHAU's trusted sliding sleeve system - same pipe, different connection technology.

PINC™ works by pushing REHAU standard PE-Xa 16 or 20 mm hot or cold water pipe into a PINC™ connector joint until it clicks – the joint is completely home when the 360° fluorescent UV pink inspection ring is fully visible - **simplicity and trust.**

PINC™ is also dark place friendly - simply shine a UV torch at the pink inspection ring to see a full circle view of the completed joint - **safety.**

It's also tool free, apart from a trusty pipe cutter - **efficiency.**



PINC™ Close Up

Strength

Grab ring

Stainless steel toothed ring capable of holding up to 2.5 tonnes pull-out force.





Visual

Guide ring

Dual functionality and the heart of the design – ensures smooth pipe insertion and provides visual confirmation of completed connection.

PINC™ Exploded

Tough

Fitting body

Made from temperature and chemical resistant engineered polymer.



Secure

Sealing rings

2x EPDM sealing rings for extra security and enhanced leak tightness.

Inside



End cap

Glass fibre reinforced black Grilamid. Securely holds all components in place.



Grab ring

Stainless Steel toothed ring capable of holding up to 2.5 tonnes pull-out force.



Guide ring

Dual functionality and the heart of the design – ensures smooth pipe insertion and provides visual confirmation of completed connection.



Inner collet

Tough thermo-plastic polymer that provides both stability and strength to the fitting.



Clear housing

Glass fibre reinforced transparent Grilamid. See what's going on inside from all directions.

REHAU PINC™

Product Range



PINC Straight Coupling

REHAU Article Code	Size
442922 - 001	PINC NO.1 COUPLING 16-16
442923 - 001	PINC NO.1 COUPLING 20-20
442924 - 001	PINC NO.1 COUPLING 20-16



PINC Elbow Male Thread

REHAU Article Code	Size
442934 - 001	PINC NO.13 ELBOW MI16 - R 1/2"
442935 - 001	PINC NO.13 ELBOW MI20 - R 1/2"
442936 - 001	PINC NO.13 ELBOW MI20 - R 3/4"



PINC Elbow 90

REHAU Article Code	Size
442925 - 001	PINC NO.12 ELBOW 90°16-16
442926 - 001	PINC NO.12 ELBOW 90°20-20



PINC Elbow Female Thread

REHAU Article Code	Size
442937 - 001	PINC NO.14 ELBOW FI16 - RP 1/2"
442938 - 001	PINC NO.14 ELBOW FI20 - RP 1/2"
442939 - 001	PINC NO.14 ELBOW FI20 - RP 3/4"



PINC Tee Piece

REHAU Article Code	Size
442917 - 001	PINC NO.24 T-PIECE 16-16-16
442918 - 001	PINC NO.24 T-PIECE 20-20-20
442919 - 001	PINC NO.25 T-PIECE 20-16-20
442920 - 001	PINC NO.26 T-PIECE 20-20-16
442921 - 001	PINC NO.27 T-PIECE 20-16-16



PINC Elbow Female Wingback

REHAU Article Code	Size
442945 - 001	PINC NO.15 BP ELB FI16-RP 1/2"
442946 - 001	PINC NO.15 BP ELB FI16-RP 3/4"
442947 - 001	PINC NO.15 BP ELB FI20-RP 1/2"
442948 - 001	PINC NO.15 BP ELB FI20-RP 3/4"



PINC Straight Connector Female

REHAU Article Code	Size
442932 - 001	PINC NO.2 STR CONN FI16-RP 1/2"
442933 - 001	PINC NO.2 STR CONN FI20-RP 3/4"



PINC Elbow Female Top Wingback

REHAU Article Code	Size
442949 - 001	PINC NO.15 BP EWB FI16-RP 1/2"
442950 - 001	PINC NO.15 BP EWB FI20-RP 1/2"
442951 - 001	PINC NO.15 BP EWB FI20-RP 3/4"



PINC Straight Connector Male

REHAU Article Code	Size
442928 - 001	PINC NO.3 STR CONN MI16-R 1/2"
442929 - 001	PINC NO.3 STR CONN MI16-R 3/4"
442930 - 001	PINC NO.3 STR CONN MI20-R 1/2"
442931 - 001	PINC NO.3 STR CONN MI20-R 3/4"



PINC Elbow Male Parallel Thread

REHAU Article Code	Size
442942 - 001	PINC NO.19 BP ELB MI16-G1/2" 65
442943 - 001	PINC NO.19 BP ELB MI16-G1/2" 90
442944 - 001	PINC NO.19 BP ELB MI20-G1/2" 95

Push Connectivity



PINC Hose Plate

REHAU Article Code	Size
442958 - 001	PINC HOSE PLATE 16 - Rp 1/2"



PINC Tee Piece Wingback

REHAU Article Code	Size
442927 - 001	PINC NO.30 T-PIECE 16-RP1/2"-16



PINC Stopper

REHAU Article Code	Size
442940 - 001	PINC NO.61 STOPPER 16
442941 - 001	PINC NO.61 STOPPER 20



PINC Transition Straight Coupling

REHAU Article Code	Size
431936 - 001	PINC NO.1 TRS COUPLING16-25RT
431937 - 001	PINC NO.1 TRS COUPLING 20-25RT

Transition to RAUTITAN compression sleeve system



PINC Straight Tap Connector With Gasket

REHAU Article Code	Size
442959 - 001	PINC NO.62 S TAP WGASK16-G1/2"
442960 - 001	PINC NO.62 S TAP WGASK20-G3/4"

Integrated gasket seal, flat



PINC Transition Tee Piece

REHAU Article Code	Size
431935 - 001	PINC TRAN T-PIECE 25RT-20-25RT

Transition to RAUTITAN compression sleeve system



PINC Straight Tap Connector

REHAU Article Code	Size
442954 - 001	PINC NO.62 S TAP CONN16-G 1/2"
442955 - 001	PINC NO.62 S TAP CONN20-G 3/4"

Integrated flexible seal, tapered



PINC Union Connector NZ

REHAU Article Code	Size
442956 - 001	PINC UNION CONN 16-DN15 NZ
442957 - 001	PINC UNION CONN 20-DN20 NZ

Transition to NZ Copper pipe - NZS 3501



PINC Bent Tap Connector

REHAU Article Code	Size
442952 - 001	PINC NO.63 B TAP CONN16-G 1/2"
442953 - 001	PINC NO.63 B TAP CONN20-G 3/4"

Integrated flexible seal, tapered

REHAU Engineered Polymers

Each perfectly selected
for purpose.



REHAU Brass

Highly dezincification
resistant brass.

Contents

1	Information and safety advice	10		
2	Pipes and fittings	12		
2.1	Technical data of pipes	12		
3	Pipe cutters	13		
3.1	Pipe cutters	13		
4	Transport and storage	13		
5	How to make a PINC™ connection	14		
6	Installation guidelines - hot and cold water	16		
6.1	General	16		
6.2	Protection against corrosion and damage	16		
6.3	Protection from contact with chemicals	16		
6.4	Installing threaded fittings	17		
6.5	Transition to other systems	17		
6.6	Pipe support and fixing	12		
6.6.1	Pipe brackets and clips	18		
6.6.2	Spacing of support brackets and pipe bending	18		
6.7	Provision for thermal expansion	19		
6.8	Installation within concrete/screed floors and walls	19		
6.9	Installation in areas exposed to UV radiation and light	19		
6.10	External installation above ground	20		
6.11	Installation below ground	20		
6.12	Installation beneath a concrete slab	21		
6.13	Exposure to excessive heat	21		
6.14	Aligning fittings	21		
6.15	Heat trace	21		
6.16	Potential equalisation	21		
6.17	Thermal insulation	22		
6.18	Noise reduction	22		
6.19	Water heater connection	23		
6.19.1	Storage water heaters	23		
6.19.2	Instantaneous water heater	23		
6.19.3	Water heaters with uncontrolled energy sources	23		
6.19.4	Solar water heaters	23		
6.20	Rainwater and recycled water application	23		
7	Operation guidelines - hot and cold water	24		
7.1	Standards and guidelines	24		
7.2	Operating parameters	24		
7.3	Hot water circulation	24		
7.4	Drinking water requirements	24		
7.5	Disinfection of water services	25		
7.5.1	Thermal disinfection and chemical disinfection in case of contamination	25		
8	Pressure testing and commissioning	26		
8.1	Water services flushing and pressure test	26		
8.1.1	Flushing and pressure test	26		
8.1.2	REHAU pressure test with water	26		
8.2	Purging and commissioning	27		



This Technical Information **REHAU PINC™ - Push In. Connect.** - is valid from **September 2021**. This publication means that the previous Technical Information is no longer valid.

The latest version of this Technical Information can be found at www.rehau.com.au/REHAUPINC or www.rehau.co.nz/REHAUPINC for download.

This documentation is copyright protected. The rights of translation, reproduction, drawing of illustrations, broadcasting, and rendering on photomechanical or by similar means as well as the storage in data processing systems, are reserved.

All measurements and weights are of approximate values.
Errors and changes are to be expected.

01. Information and safety advice

Notes on this Technical Information

This Technical Information is an addendum to REHAU's Technical Information "RAUTITAN - Water, Fire Sprinkler and Gas" and defines additional requirements when using PINC™ fittings. It shall be read in conjunction with the above mentioned TI in its latest edition.

Validity

This Technical Information is valid for Australia and New Zealand.

Definitions

- **PINC™ connection** means a REHAU push-fit connection to form a seal between a PINC™ fitting and RAUTITAN pipe.
- **PINC™ fitting** means fittings made of brass or engineered polymer with at least one PINC™ connection end (e.g. coupler, elbow, T-piece, adapter, union connector etc.)
- **PINC™ system components** means both PINC™ fittings and RAUTITAN PE-Xa pipes.
- **PINC™ system, supply line, piping or installation** consists of PINC™ fittings, RAUTITAN PE-Xa pipe, connections (push-fit, thread, or similar) and fixings.
- **RAUTITAN pipe or RAUTITAN PE-Xa pipe** means REHAU RAUTITAN pipe SDR 7.4 made of PE-Xa (platinum, red, green and lilac) as described in REHAU's Technical Information "RAUTITAN - Water, Fire Sprinkler and Gas".
- **RAUTITAN stabil or RAUTITAN gas stabil** means REHAU PE-X/AL/PE multilayer pipe with inner aluminium layer. The combination of these pipes with PINC™ fittings is not allowed.
- **RAUTITAN pink or RAUTHERM S** means REHAU's PE-Xa pipe with outer oxygen barrier for heating application. The combination of these pipes with PINC™ fittings is not allowed.
- **Pipe support channel** means REHAU's zinc plated clip-on channel to limit thermal length changes and pipe sagging in RAUTITAN PE-Xa pipes.



Updated Technical Information

For your own safety and the correct use of our products, check regularly whether there is a newer version of this Technical Information available. The date of issue of your Technical Information is always printed on the bottom left of the cover.

The latest Technical Information can be found at your REHAU sales office, specialist wholesaler or online for download at www.rehau.com, www.myREHAU.com.au, www.rehau.co.nz or www.myREHAU.co.nz.

Explanation of symbols



Safety information



Legal information



Important information, which needs to be taken into account



Information on the Internet



Your benefits/advantages

Safety advice and operating instructions

- Please read these safety instructions and technical information carefully and completely for your own safety and other's before beginning the installations.
- Please keep this copy for your future reference.
- If you have any questions or need further clarifications on the safety instructions and/or the individual installation instructions, please contact your nearest REHAU sales office.
- Failure to observe the safety information/instructions can result in damage to property and persons.

Intended use

The REHAU PINC™ system components is considered as propriety systems and should be designed, installed, and operated in accordance to REHAU's Technical Information. Any other use that does not fall within the intended use of the system is prohibited.

When installing this pipe system, please observe all applicable national and international regulations on installation, accident prevention and safety together with the information contained in this Manual.

Also observe the applicable laws, standards, guidelines and regulations (e.g. DIN, EN, ISO, NCC, BCA, PCS, NZBC, AS/NZS) as well as regulations on environmental protection, provisions of professional associations and regulations of the local public utility companies.

Any applications not described in this Manual - i.e. non-standard applications - must be discussed with our Technical Applications Department. For more detailed advice, please contact your REHAU Sales Office.

This design and installation information is related solely to the specific REHAU product. Occasionally, references are made to parts of applicable standards and directives. Always observe the current version of any guidelines, standards or directives.

Further, directives and guidelines related to the design, installation and operation of drinking water or building services systems should also be referred to, but these do not form part of this Technical Information.

General safety measures

- Keep your workplace tidy and free of obstructions.
- Ensure there is always sufficient light.
- Keep children, pets and unauthorised persons away from tools and installation areas. This is especially important when carrying out refurbishment/repair work in occupied areas.
- Only use the corresponding components in the piping system that have been generally approved by REHAU. Using components which are not part of the system or tools which do not originate from the respective REHAU installation system can lead to accidents or other hazards.

Fire protection

Pay particular attention to the applicable fire protection regulations and the corresponding building regulations / regional building regulations / building codes, especially when:

- Penetrating through ceilings and walls
- Working in areas with specific requirements of preventative fire protection measures (observe national regulations)

Trades qualifications

- Only authorised and fully licenced persons are allowed to install REHAU systems.

Work clothing

- Wear eye protection, adequate work clothing, protective shoes, safety helmets, and a hairnet if you have long hair.
- Do not wear loose clothing or jewelry as these can be caught by moving parts.
- A safety helmet must be worn especially when carrying out installation work at face level or overhead.

Follow the installation instructions

- The REHAU pipe cutters have a sharp blade. Store and handle them in such a way that they will not create any risk of injury.
- Incorrect handling of pipe cutters can cause cuts, or sever limbs.
- When cutting the pipe to the desired length, keep a safe distance between the holding hand and the tool (pipe cutter).
- When cutting, do not reach into the cutting zone of the tool or near its moving parts.

Operating parameters

- If the operating parameters are exceeded, the pipes and joints may become overstrained. Not adhering to the operating parameters is thus not allowable.
- Keeping within the operating parameters must be ensured by safety control equipment (e.g. pressure reducers, safety valves, etc.)

02. Pipes and fittings

2.1 Technical data

REHAU PINC™ fittings are specifically designed to suit REHAU RAUTITAN pipe SDR7.4 (PN20) made of PE-Xa.

REHAU PINC™ fittings are not approved for use with RAUTITAN stabil, RAUTITAN gas stabil, RAUTITAN pink or RAUTHERM S pipe for heating application or any other pipe system.

RAUTITAN pipes comply with AS/NZS 2492 and PINC™ fittings comply with AS/NZS 2537. RAUTITAN pipe is designed to operate with a working pressure of 2,000 kPa at 20°C, or continuous operation at 70°C with a maximum working pressure of 1,000 kPa.

RAUTITAN pipe and PINC™ fittings are tested and approved to AS/NZS 4020.

PINC™ fittings

Fitting

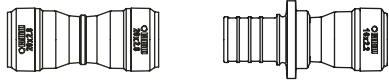

Material	Engineered polymer (lead content 0%)	DZR Brass
Application	Hot and cold water	Hot and cold water
Size	16 20	16 20
Colour	Dark grey / clear	Brass
Connection Type	Threadless	With threads

Tab. 2-3 REHAU PINC™ fittings

Dezincification resistance

- Under the effects of certain types of drinking water, a particular form of corrosion known as dezincification can occur in brass.
- REHAU PINC™ brass fittings used in water services installation are made of special dezincification-resistant brass and are tested for drinking water installation according to ISO 6509 and AS 2345.



Use REHAU PINC™ fittings only in combination with RAUTITAN PE-Xa pipes SDR 7.4 for hot and cold drinking water application. For other applications contact the REHAU Technical Department for approval.

Do not use REHAU PINC™ in combination with RAUTITAN stabil pipe, RAUTITAN gas stabil pipe, RAUTITAN pink pipe or RAUTHERM S pipe for heating application, or any other pipe system.

RAUTITAN pipe SDR 7.4

SIZE	16X2.2mm (OD 16)	20X2.8mm (OD 20)
Colour and Application	Platinum - Hot & Cold potable water Dark red - Hot potable water Green - Rainwater Lilac - Recycled water	
Material	PE-Xa	
Operating pressure (maximum)	10 bar	
Operating temperature (AS 2537.1 class 1 / 10 bar & 2 / 10 bar) - Continuous	70 °C	
Short-term maximum temperature (malfunction)	95 °C	
Maximum/minimum laying temperature	+50 °C / -5 °C	
Building material class acc. DIN 4102-1	B2	
Construction product class acc. EN 13501-1	E	
Thermal conductivity	0.35 W (m*K)	
Pipe roughness	0.007mm	
Pipe volume	0.106 l/m	0.163 l/m
Pipe weight, empty	0.097 kg/m	0.152 kg/m
RAUTITAN and PINC™ system appraisals and certificates	WaterMark (LN 1412, LN 1413) to AS 2492, AS/NZS 2537, AS/NZS 4020, AS 2345 (further compliance certificates available on request)	



Pipes can be subjected to maximum operating temperature or maximum operating pressure and not both.

03. Pipe cutters

3.1 Pipe cutters

When cutting RAUTITAN pipes, observe the following:

- Use the correct pipe cutters for the corresponding pipe type only.
- Cut the pipe square and without burrs.
- Pipe cutters must be in good working condition.
- Spare blades for pipe cutters can be re-ordered (except for pipe cutter 25).
- Do not use a saw, knife or other tool to cut the pipe.

Suitable pipe cutters for PINC™ system:

Pipe cutter 16/20 (stabil)



Pipe cutter 25



Pipe cutter 40



*Ensure that the pipe is cut square and not at an angle!

04. Transport and storage

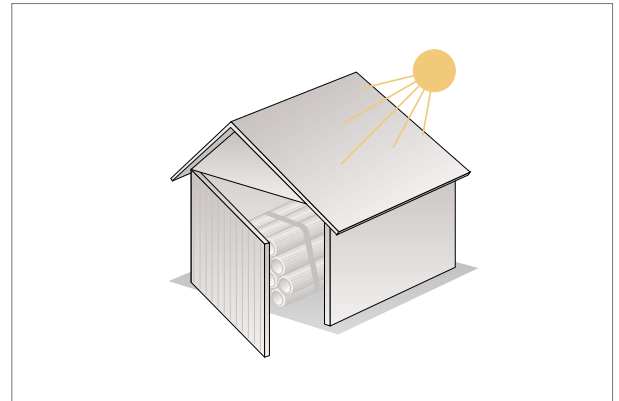

Fig. 4-1 Protect pipes against sunlight

Protect pipes and fittings against UV radiation during storage and transportation. When laying in areas where UV-radiation (e.g. sunlight, neon light) can occur, cover the piping fully with UV-proof material.

General safety measures

- Load and unload with due care.
- Only transport in a fashion suitable for the material.
- Do not drag over floors or concrete surfaces.
- Store on a flat surface with no sharp edges.
- Protect against mechanical damage.
- Protect against dirt, drilling dust, mortar, grease, oil, paint, solvents, chemicals, humidity, etc.
- Protect against sunlight, e.g. with an opaque film or similar material.
- Protect against long sunlight exposure during the construction phase.
- Only unpack fittings shortly before installing.
- For hygiene reasons, cap or seal open pipe ends and protect pipes and fittings from contact with harmful substances.

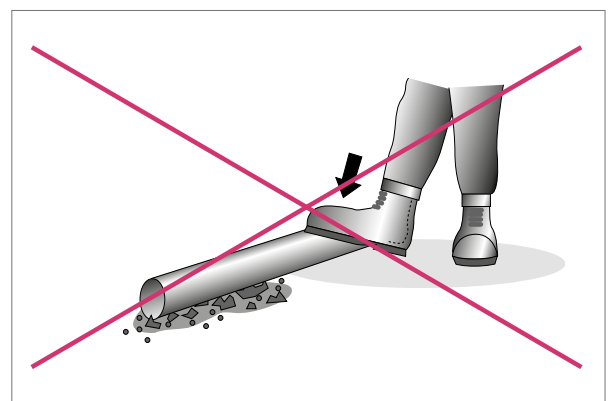

Fig. 4-2 Do not store pipes on sharp-edged surfaces

05. How to make a PINC™ connection

Installation temperature

- Minimum installation temperature is $-5\text{ }^{\circ}\text{C}$.
- Maximum installation temperature is $+50\text{ }^{\circ}\text{C}$.

Step 1

- Cut the pipe square using REHAU approved pipe cutters only.
- If the pipe was cut improperly, re-cut the pipe to ensure a square and burr-free cut.

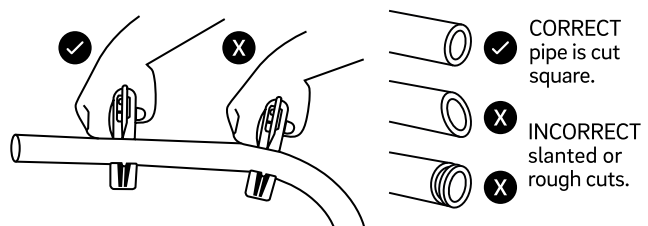

Step 2

Ensure the pipe end is straight and pipe end and fitting are free from any foreign material (e.g. lubricant, adhesive or tape).

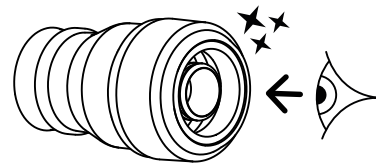

Step 3

Push the pipe into the PINC™ fitting until it stops, and at the same time, listen for the audible "CLICK".

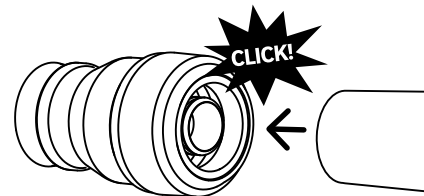

Step 4

- Verify that the pink guide ring is fully visible.
- In case the pink guide ring is not visible, complete pipe insertion. Note - avoid further pipe insertion when the system is already under water pressure. De-pressurise the system before completing pipe insertion.

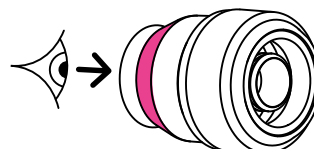

Handy tips

- Always pressure test system on completion and before covering the pipe or fittings as per AS/NZS 3500.
- Cover fitting ends from falling dust and debris, particularly when working (ie drilling timber) overhead.
- If the pipe is difficult to insert or does not engage, do not force the pipe. Remove and check for obstructions.
- Perform jointing only on a straight pipe section, not on a pipe bend or with pipe inserted at an angle.
- Avoid excessive bending stress on the connection.

Insertion depth

- When the pipe is fully inserted, the pipe end roughly aligns with the end of the black inner collet.
- The end of the black inner collet can therefore be used as a guidance for estimating the required cut length for the pipe.

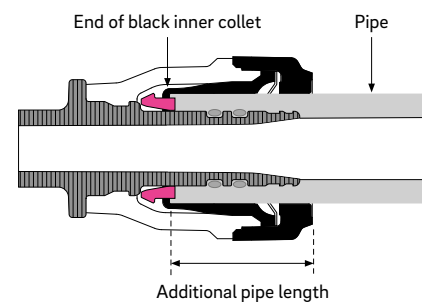

Reusing jointing components

REHAU PINC™ fittings shall not be reused or detached and must be disposed.

Safety information

- Only use RAUTITAN PE-Xa pipes SDR 7.4 (platinum, red, green, lilac) and no other pipe.
- Protect RAUTITAN pipes and PINC™ fittings from contact with alcohol (e.g. Isopropanol, Ethanol, Methylated Spirits), acetic acid, grease and oil, petrolatum, primers, solvents, glues/adhesives, paint and lacquer and other harmful substances. For details refer to chapter 6.

06. Installation guidelines - hot and cold water

6.1 General

- Do not use dirty or damaged system components, pipes, fittings, compression sleeves or seals.
- Make sure that the connection components are free of inadmissible stress during assembly and when in operation.
- Make sure that the piping has sufficient scope of movement (e.g. from deflection legs).
- Protect the system against damage (e.g. during the construction phase and when installed in areas with vehicles or machines).

Installation temperature

- Minimum installation temperature is -5°C
- Maximum installation temperature is +50°C

6.2 Protection against corrosion and damage

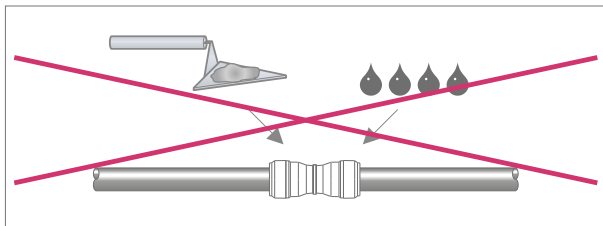

Fig. 6-1 Protect connection components from corrosion

- Screed, cement, mortar, plaster, bonding agents and other materials and substances may cause corrosion. Where contact with such substances is foreseeable, protect fittings and compression sleeves from contact, e.g. by wrapping with RAUTITAN protective tape, silicone tape or another suitable tape. Petrolatum tape, or tapes containing solvents are NOT suitable.
- Do not install pipes and fittings in wet areas, e.g. green houses, indoor pools, or conditions where water or condensation on the surfaces must be expected on a regular basis.

6.3 Protection from contact with chemicals

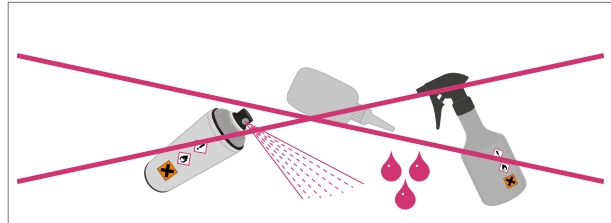

Fig. 6-2 Avoid contact with alcohols, acetic acid, solvents, primers and glues, paints, lacquer, liquid thread sealant and oil.

Protect RAUTITAN pipe and PINC™ fittings from contact with:

Substance*	Examples*
Alcohol	Isopropanol, Ethanol, Methylated Spirits
Acid (Acetic, Formic, Nitric)	Pesticides, industrial cleaners, some household cleaners
Glues/adhesives	Liquid thread sealant, PVC glue, insulation glue, gyprock glue, tape, other glues or tapes which are not specifically approved for polymer materials
Grease and Oil	Cutting oil and other oils, greases, Petrolatum
Paint and Lacquer	All paints and lacquers, including water based
Primers	PVC primer, paint primers, other primers
Solvents	Cleaning agents, acetone, ketone, ether, MEK, marker pens, PUR building foams, paint stripper, other substances containing aromatic or oxygenated solvents
Other	Avoid contact with any substance that cause stress cracking or corrosion, i.e. Plasticisers, ammonia, halogenated hydrocarbons, or chloride ions that can leach.

* The substances mentioned above reflect our current knowledge of substances that may be part of chemicals used on construction sites which can cause stress cracking or corrosion to fittings or pipes; any new substance that may be forthcoming in the future may not be compatible will be excluded from our warranty upon notification.

If incidental contact occurs, confirm compatibility with RAUTITAN pipes and PINC™ fittings.

When installing RAUTITAN and PINC™ in aggressive environments (e.g. exposed to cleaning agents, aggressive gases, chloride mediums), protect pipes and fittings against corrosion adequately and in such a way that they are sealed against vapours.

6.4 Installing threaded fittings

General installation requirements

- Avoid over-tightening threaded joints.
- Only use sealants approved for gas and water installation.
- Do not apply excessive hemp to threaded joints.
- The thread tips must be visible.
- Use open-end wrenches in the right size. Do not clamp fittings too tightly into the vice.
- Do not extend the leverage of installation tools, e.g by extending the handle length.

Compatibility of different thread types

- Only the following thread types may be used with PINC™ system: sealing threads in accordance with ISO 7-1 (AS 1722.1) and EN 10226-1:
 - Rp = cylindrical female thread
 - R = tapered male thread fastening pipe threads in accordance with ISO 228 (AS 1722.2):
 - G = cylindrical thread, non-sealing in thread
- Check compatibility of different thread types before screwing them together, e.g. tolerances, free movement.
- Only use an appropriate G male connector with flat sealing thread fittings with G female thread.
- If using long threads, ensure the maximum possible screwing depth and sufficient thread depth in opposing parts with inside threads.

Threaded connections with integrated seals or gaskets

- Confirm compatibility of the seal with the sealing surface of the counterpart.
- When joints with integrated seals or flat-sealed joints (or similar) are opened, check that the sealing surface is undamaged before reconnecting and insert a new seal if necessary.

6.5 Transition to other systems

PINC™ fittings can only be directly connected to RAUTITAN PE-Xa pipe OD16 respectively OD20.

Connection to other pipe materials can be made as follows:

RAUTITAN and other plastic pipes

To adapt to RAUTITAN pipe OD 25 or larger, use suitable PINC™ fitting adapters.

Transition fittings from PINC™ system to a range of other systems available, refer to the current product book for PINC™ system.

Copper

- Refer to the current product book for options to adapt to copper pipe systems.

Brazing connections

- PINC™ fittings are not suitable for brazing and must be kept away from flames and excessive heat.
- Brazing joints on copper pipes shall be made before connecting to PINC™ system.
- After brazing the pipe must completely cool down before adapting to PINC™ system.

Stainless steel

- A direct transition to stainless steel installation systems is not permitted. Use a non-stainless steel interim piece for the connection of both systems, e.g. a combination of: PINC™ brass threaded adapter with male thread - threaded socket - threaded adapter with male thread made of stainless steel. A transition piece made of gunmetal between both fittings is recommended.
- Only use mating threads according to AS 1722.1, ISO 7-1 and EN 10226-1 (Rp/R).

06. Installation guidelines - hot and cold water

6.6 Pipe support, bending and fixing

6.6.1 Pipe brackets and clips

Use only pipe brackets and clips with the following properties:

- Suitable for plastic pipes.
- Improved acoustic properties through rubber lining.
- Correct size (to allow easy gliding of pipe without pulling the rubber lining out).
- Free of burrs.

6.6.2 Spacing of support brackets and pipe bending

Pipe installation	RAUTITAN pipe SDR 7.4	
Size	16x2.2mm (OD 16)	20X2.8mm (OD 20)
Pipe volume	0.106 l/m	0.163 l/m
Pipe weight, empty	0.097 kg/m	0.152 kg/m
Recommended bracket spacing		
Horizontal installation	0.60m (concealed) 0.30m (exposed*)	0.70m (concealed) 0.40m (exposed*)
Vertical installation	1.20m	1.40m
With REHAU pipe support channel (horizontal or vertical)	2.00m	2.00m
Bending radius		
Using bend brackets for plumbing (3xD)	R=50mm	R=60mm
Using bend brackets for heating (5xD)	R=80mm	R=100mm
Bending by hand (8xD)	R=130mm	R=160mm

*For installation of pipes without support channel, pipe sagging is to be anticipated. To improve appearance, reduce bracket spacing or install pipe support channel.

i For installation of RAUTITAN PE-Xa pipes without pipe support channel, pipe sagging is to be anticipated.

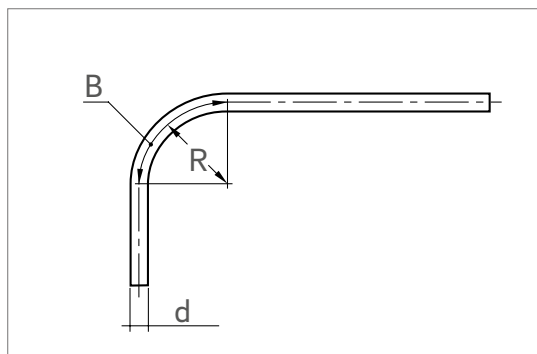

Fig. 6-3 Pipe bend
 R Bending radius
 B Arc
 d Pipe diameter

6.7 Provision for thermal expansion

Due to the changing operational temperatures, especially in hot water pipes, any pipe material will undergo thermal expansion. This thermal expansion needs to be managed in a safe way to avoid tension in unwanted locations along the pipe length.

Any fixed points that restrict the free expansion and contraction of the pipe must be avoided. Such fixed points may inadvertently be created when fittings are installed close to penetrations in walls, floors, joists or other fixed building elements.

Make sure that the piping has sufficient scope for movement (e.g. from deflection legs).

The thermal change in pipe length is calculated with the following equation:

$$\Delta L = \alpha \cdot L \cdot \Delta T$$

ΔL	=	Length change in mm
α	=	Coefficient of linear thermal expansion 0.15 in $\frac{mm}{m \cdot ^\circ C}$
L	=	Length of piping in m
ΔT	=	Temperature difference in $^\circ C$

For further information on RAUTITAN thermal length changes and calculation of deflection legs refer to the latest edition of REHAU's Technical Information "RAUTITAN - Water, Fire Sprinkler and Gas".

6.8 Installation within concrete/screed floors and walls

Installation of PINC™ systems within concrete/screed floors and walls are allowed, provided specific requirements from local installation standards are fulfilled and adequate protection from mechanical damage and chemical damage are provided. Fittings shall be wrapped with suitable tape to avoid direct contact with concrete. Pipe must be laid in conduit.

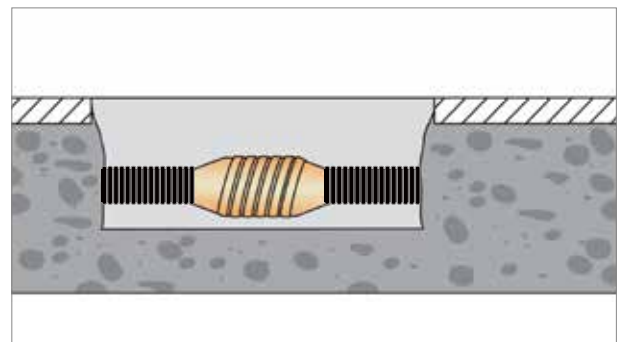

Fig. 6-7 Installation of PINC™ system within concrete/screed floor with corrosion protection system

6.9 Installation in areas exposed to UV radiation and light

- Pipes and fittings must be protected against UV radiation during storage and transportation.
- Protect piping from UV rays in areas where UV radiation can occur (e.g. sunlight, neon light), ie: by installing in black conduit.
- RAUTITAN PE-Xa pipes shall be installed in dark areas or protected in conduit to prevent biofilm growth.

06. Installation guidelines - hot and cold water

6.10 External installation above ground

RAUTITAN and PINC™ system components shall in general not be installed above ground, except for the following:

- Short pipe length after connection to water meter before going in ground.
- Connection to an externally located water heater.

For the above exceptions, the following must be ensured:

- The length of pipe installed above ground shall be kept to an absolute minimum not exceeding 2 metres. Below ground installation should always be preferred.
- All pipe and connections must be adequately protected from corrosion, frost and excessive temperature.
- The system components must be protected from any mechanical and physical damages. Consideration shall be given to the type and level of damage which is likely to occur during the long term operation of the system, e.g. UV-radiation, lawn mower, etc.

6.11 Installation below ground



All below ground installations shall follow the applicable water installation standards.

General

RAUTITAN and PINC™ system components can be installed in the ground if they are adequately protected against mechanical and chemical damage and contamination. Laying of RAUTITAN pipes or PINC™ fittings in contaminated soil (ie. petrol, benzene, paint, solvent etc.) is not permitted.



If chemical damage is likely to occur, e.g. from termite treatments, RAUTITAN pipes and PINC™ fittings shall be adequately protected using a suitable conduit, e.g. PVC pipes or equivalent.

Bedding and backfill

The quality of bedding and backfill material must be in accordance with valid national water installation standards.

Corrosion protection

All joints in ground, must be protected against corrosion using a recognised corrosion protection system, such as the Denso DEKOTEC N15/PE5 system or equivalent. Do not use protective tapes containing Petrolatum, solvents or other harmful substances.

The corrosion protection system shall cover a minimum of 150 mm of the pipe on each side of the joint. Ensure mechanical protection is provided to avoid any damage to the corrosion protection tape e.g. by backfill material.

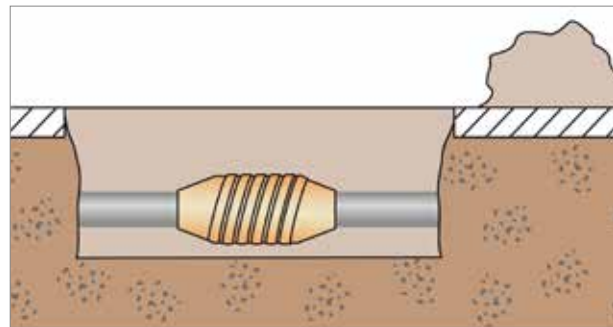

Fig. 6-8 Installation of RAUTITAN system below ground with PINC™ fittings wrapped with corrosion protection system

6.12 Installation beneath a concrete slab

AS 2870-2011 "Residential slabs and footings" requires cold water pipes and heated or hot water pipes installed under a slab to be installed within a conduit so that if the pipe leaks water it will be noticed above the slab or outside the slab and will not leak unnoticed under the slab.

6.13 Exposure to excessive heat

During construction, maintenance or repair work in close proximity to heat, care must be taken not to expose the piping systems to a naked flame (soldering), flood lights or other localised heat sources. This can result in permanent damage or a significant reduction in performance life.

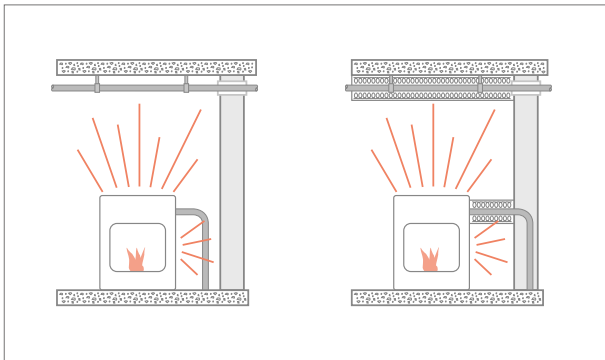

Fig. 6-9 Protection against temperature-induced stress

6.14 Aligning fittings

Only align fitting with suitable tools, e.g. pipe nipples or open-end wrenches. Do not use a hammer or similar to align fittings.

6.15 Heat trace

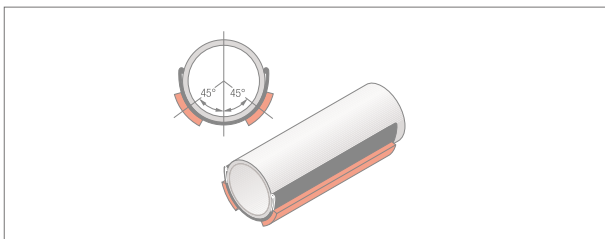

Fig. 6-10 Example of trace heating fitted to RAUTITAN pipe with support channel

The use of heat trace on RAUTITAN pipes and PINC™ fittings is permissible provided the heat trace temperature is limited to 70°C at any point.

In pipes installed with pipe support channel the heat trace must be attached to the outside of the pipe support channel.

Observe the installation manual of the auxiliary heating manufacturer and ensure that any tape used to fix the heat trace to the pipe is suitable for contact with polymers (plastics).

6.16 Potential equalisation

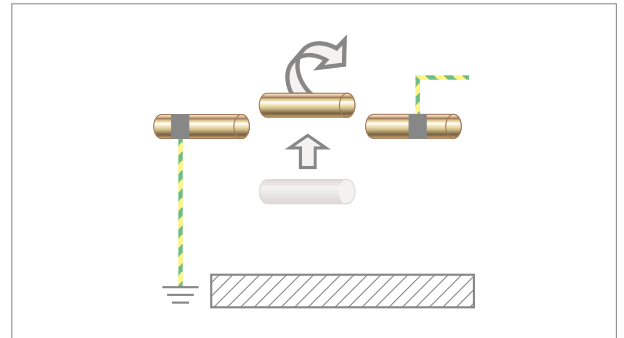

Fig. 6-11 Potential equalisation while replacing pipes



PINC™ system and RAUTITAN piping shall not be used as an earthing conductor.

After replacement of existing metal pipe installations with PINC™ system, the function of potential equalisation and the effectiveness of the electrical safety devices must be verified by an electrician.

06. Installation guidelines - hot and cold water

6.17 Thermal insulation

Thermal insulation requirements for hot and cold water services are specified in the National Construction Code NCC and in AS/NZS 3500.

In cold water applications, the likelihood of pipe damage due to freezing can be reduced. It is, however, not possible to prevent static water from freezing completely. For longer periods during which freezing is likely to occur, pump warm water periodically through the pipe system. Alternatively, the complete system should be drained.

REHAU offers pre-insulated pipes with 13 mm concentric insulation to minimise heat loss in hot water applications.



Fig. 7-1 Pre-insulated pipe

Material:	Co-extruded PE-foam with moisture barrier PE layer, CFC free.
Thermal conductivity:	0.04 W/mK
R-value:	0.3
Spread of Flame Index:	5
Smoke Developed Index:	5
Suitable use:	installation in concealed areas in all types of building specified by BCA



Pre-insulated pipes are not suitable for exposed installation in fire-isolated areas.

6.18 Noise reduction

Acoustic properties of PE-Xa pipes:

Fraunhofer Institute for Structural Physics in Stuttgart conducted a study of the sound level differences of PE-Xa, copper and galvanised steel pipes. Three common pipe diameters were compared under identical conditions such as dynamic pressure and flow rate.

The report shows that PE-Xa pipes generated up to four times less noise (sound level difference LA = 12.7 dBA) than the metal pipes. A complete copy of the report is available on request.

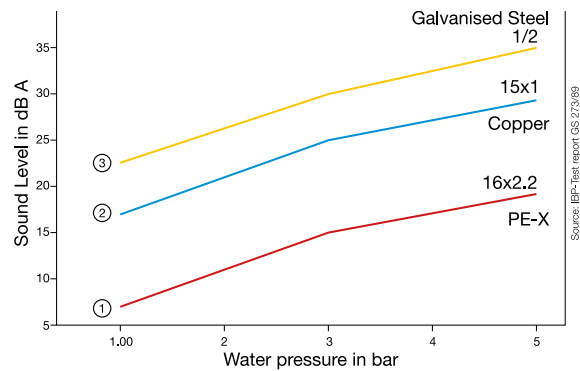

Fig. 7-2 Result of acoustics report from Acoustics Division of the Fraunhofer Institute of Structural Physics

Effects of water hammer:

The low elastic modulus of PE-Xa pipes and their ability to expand quickly and contract slowly enables the pipes to absorb water hammer effectively.

In cold water service installations, the water hammer effect can be reduced by up to 75% compared to metal pipe installations.

6.19 Water heater connection

REHAU recommends the installation of both isolation valve and non-return valve connected directly to the inlet of every water heater or with metallic piping between the valves and the water heater. REHAU recommends that the non-return valve be connected closest to the water heater and with the isolation valve at the up-stream of the non-return valve.

6.19.1 Storage water heaters

All storage water heaters should be fitted with operational temperature and pressure relief valves for safety in the event of malfunction of the heater's operation. The rating of the temperature and pressure relief valve must be determined by the storage water heater manufacturer in terms of maximum temperature and pressure as required for the design and operational requirements of the water heater.

If the storage water heater does not have provision on the heater for fitting such a valve, REHAU recommends the installation of a temperature and pressure relief valve on the tee-connection of the heater's hot water outlet and its outlet piped to a drain location. This will allow the release of hot water during the heater's normal operation and in the event of safety operation of the valve. REHAU also recommends that the valve be operated manually every six months.



REHAU recommends that the outlet of storage water heaters be fitted with a minimum of 1 meter of metallic piping prior to the installation of PINC™ system.

6.19.2 Instantaneous water heater

Before connecting RAUTITAN pipe to either electric or gas fuelled instantaneous water heaters, the installer must check the appliance manufacturer's instructions regarding the connection of polymer pipes. The appliance operational temperature and pressure may exceed the capabilities of PINC™ system and might cause failure of the piping. Some manufacturers of instantaneous water heaters state that connection of their appliances to polymer pipe systems is not suitable or subject to restrictions.

The installer must confirm with the appliance manufacturer that the maximum operational limits of the appliance will not exceed those of the system. REHAU recommends that only appliances with temperature control devices which can, at all times, restrict the outlet water temperature to within the system's capabilities, be installed in conjunction with the PINC™ system.

6.19.3 Water heaters with uncontrolled energy sources

PINC™ system components should not be used with uncontrolled energy sources and installation of a tempering valve is required.

6.19.4 Solar water heaters

As per AS/NZS 3500 requirement, polymer pipe systems must never be used on the flow and return piping to any solar panel.

Solar collectors and other uncontrolled heat sources generally have operating conditions which exceed those of PINC™ system.



- Never use the PINC™ system components in the flow and return piping to any solar collectors/panels.
- Do not install PINC™ system components in the flow and return of any uncontrolled heat source (e.g. wood fire heaters, etc.).
- If a heat storage tank is used, PINC™ system components can be used after the tempering valve. Potential back siphoning of super heated water through the cold port of the tempering valve from cold feed to the uncontrolled heat source (including solar panels) must be prevented through adequate measures, e.g. fitting a suitable high temperature rated non-return valve between the cold feed to the solar panels and the tempering valve.

6.20 Rainwater and recycled water application

For guidelines on correct installation and operation of rainwater applications or recycled water applications refer to REHAU's Technical Information for RAUTITAN system in its latest revision.

07. Operating Guidelines - hot and cold water

7.1 Standards and guidelines

RAUTITAN pipe and PINC™ fittings for water services must be planned, calculated, installed and operated according to AS/NZS 3500 and other relevant standards.

7.2 Operating parameters

For continuous operation, the following parameters must not be exceeded.

Application:

Hot water supply at 70°C / 1 MPa (10 bar)
(Application class 1-2 acc. ISO 10508)

The above continuous operating parameters are based on a life span of 50 years and allow for short periods of higher temperatures as listed in the following table:

Design temperature T_D / Time T_D	70°C / 49 years
Short-term maximal temperature T_{max} / Time T_{max}	+ 80°C / 1 year
Short-term malfunction temperature T_{mal} / Time T_{mal}	+ 95°C / 100 h
Total = 50 years	

Tab. 7-1 Operating parameters according to AS/NZS 2537.1 and ISO 10508 (Application classes 1 and 2)

7.3 Hot water circulation

RAUTITAN pipe and PINC™ fittings are suitable for installation in hot water circulation (ring main) applications, with or without copper pipes installed in the same line, provided the temperature does not exceed 70°C and the operating pressure is limited to 10 bar (1,000 kPa). The maximum permissible water velocity under those conditions is 3.0 m/s.

Note - AS/NZS 3500.4 limits the maximum permissible velocity to 2.0 m/s.

In buildings with in-house water treatment (ie. water softening, disinfection) and hospitals we recommend confirming the water chemistry parameters with REHAU prior to installing PINC™ system in hot water circulation (ring main) applications.

7.4 Drinking water requirements

The drinking water must comply with the currently valid limits of the following standards:

- Australian Drinking Water Guideline
- Drinking-water standards for New Zealand

PINC™ brass fittings are made of dezincification- resistant (DZR) brass and comply to AS 2345. Nonetheless, no material exists that can be used for every application.

In some specific cases, even drinking water qualities within the permitted range of the drinking water guideline and standards have properties that may negatively affect DZR brass fittings and lead to corrosion.

The maximum disinfection agent concentration mentioned in above guidelines shall only be applied during temporary disinfection and not continuously. Refer to chapter 7.5.

In locations with highly corrosive water composition, e.g. in volcanic areas, installations using bore/well water etc., the suitability of RAUTITAN pipe and PINC™ fittings must be checked with REHAU. In some cases, the available water quality may void the REHAU warranty unless appropriate water treatment is provided.

Water chemistry limitations

High levels of chloride contents combined with low levels of hydrogen carbonate contents may negatively influence the corrosiveness of the drinking water and lead to dezincification of DZR brass materials.

To avoid corrosion of REHAU PINC™ brass fittings in drinking water application, the following limits shall not be exceeded:

Chloride contents (Cl-)	≤ 200 mg/l
Sulphate content (SO42-)	≤ 240 mg/l
Calculated calcite solubility capacity (achieved as soon as pH value ≥ 7.7)	≤ 5 mg/l

Treated drinking water (e.g. softened water) may be corrosive to RAUTITAN components.

- Verify supplied water from the treatment plant suits all materials used in the water installation system.
- REHAU explicitly recommends to consult an expert or the system manufacturer for an assessment of the individual situation and to ensure correct design, installation and

operation of water treatment plants. It is the responsibility of the system designer to ensure that the above-mentioned factors and parameters are taken into account to prevent corrosion and scaling. If the drinking water quality is outside the limits of the drinking water guidelines or above limits or if previous experience indicates corrosive tendencies of the supplied water, consult REHAU before using RAUTITAN pipe or PINC™ system.

7.5 Disinfection of water services

Ensure the maximum concentration and application duration of chemical disinfection consisting of either free Chlorine or Chlorine Dioxide, as shown in Fig. 7-2 are not exceeded at any time. The maximum application duration refers to the maximum accumulated duration during the entire lifespan of the system.

Decription ¹⁾	Application temperature in the piping	Max. application concentration ²⁾	Max application duration in the piping ³⁾
Chlorine Cl ₂	Max. 50°C	Max. 5 mg/l	continuously
	> 50°C	Consult REHAU	
Chlorine di-oxide ClO ₂	Max. 60°C	Max. 0.2 mg/l ClO ₂	4 months

Tab. 7-2 Chemical disinfection with finite period

1) The corresponding notes in the safety data sheets of the manufacturer must be adhered to.

2) REHAU approval: this value may not be exceeded at any stage of the entire application duration of the installation.

3) Maximum application duration is an accumulation of the entire system lifespan.

Operating pressure 600 kPa assumed for all conditions.

In hot water application above 50°C, the maximum permissible concentration of free Chlorine depends on the operating conditions (temperature, usage pattern) and water quality (pH value, ORP). Consult REHAU for advice.

Contact your local REHAU office for advice on operating conditions other than outlined above.

We generally exclude other non-listed disinfectant from being used, especially strong oxidants (e.g. ozone), Chloramine etc.

7.5.1 Thermal disinfection and chemical disinfection in case of contamination

For information on thermal disinfection requirements for RAUTITAN pipe as well as chemical disinfection in case of contamination, refer to the latest edition of REHAU's Technical Information "RAUTITAN - Water, Fire Sprinkler and Gas".



Chemical and thermal disinfection procedures when carried out incorrectly can lead to permanent damage to drinking water installation components.

Prior to commencing such procedures, it needs to be ensured that all parts of the installation system are thermally and chemically suitable for the corresponding measure. If necessary, please have this approved by the disinfectant's manufacturer.

With thermal disinfection, it is important that the appropriate measures be taken to ensure that people are not scalded.

When carrying out discontinuous chemical disinfection it must be guaranteed that water is not used for human consumption (e.g. as drinking water) at any time during the disinfection phase, including the subsequent flushing/rinsing phase.

The safety advice from the disinfectant manufacturers must be observed.

08. Pressure testing and commissioning

8.1 Water services flushing and pressure test

8.1.1 Flushing and pressure test

A visual check shall be carried out prior to pressure testing to ensure all connections are completed and the pipe is fully inserted (pink indicator ring must be visible).

Flushing of the system shall occur prior to and after pressure testing.

Flushing and pressure testing may be conducted in accordance with AS/NZS 3500, or by following the REHAU recommendations below.



The successful execution and documentation of a pressure test is a prerequisite for any warranty claims from REHAU.

Notes

The temperature difference between the pipe and test medium may influence the pressure test and may give false readings. A temperature change of 10°C corresponds approximately to a pressure change of 0.5 to 1 bar (50 to 100 kPa). For this reason, every effort should be made to ensure that the temperature of the test medium remains constant during the pressure test.

In this context, it is important to carry out a visual inspection of all joints while the pressure test is in progress, since experience has shown that minor leakages cannot always be detected simply by monitoring the pressure gauge.

8.1.2 REHAU Pressure test with water

The REHAU recommended pressure test procedure is an alternative solution to the requirements as described in AS/NZS 3500.

General requirements and notes:

- Conduct the pressure test on the completed but not yet concealed piping before commissioning.
- During pressure test, conduct a visual check of all unconcealed pipe work as the system's leak-tightness can't be derived from the pressure fluctuation (constant, decreasing, increasing) alone.
- Subdividing the piping system into smaller test sections may increase the test accuracy.

Preparation

1. Piping shall be accessible and not be concealed.
2. Dismount safety devices and meters as necessary and replace with pipes or pipe stoppers.
3. Fill the piping system from the lowest point with filtered drinking water and purge all air. Ensure all outlets are closed.
4. Connect the pressure testing equipment at the lowest point on the drinking water installation. The measurement precision shall be 100 hPa (0.1 bar) or better.
5. During pressure test, ensure temperature fluctuations are kept to a minimum.

Pressure test with water

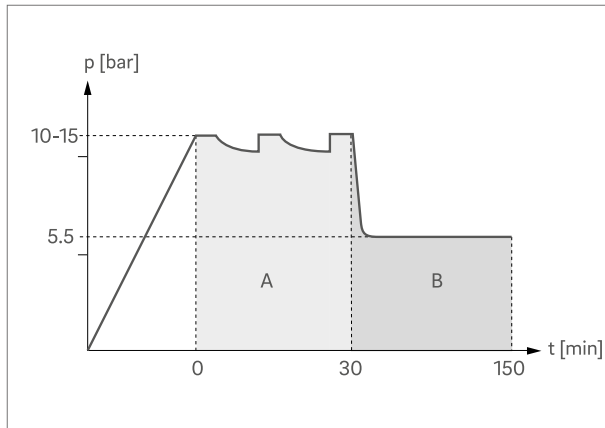

Fig. 7-3 Pressure test diagram

A Adaptation time (if necessary restore the pressure) **B** Pressure test for installations with RAUTITAN PE-Xa and installations with RAUTITAN PE-Xa pipes mixed with metal pipes

1. Determine an initial test pressure "X" between 10 and 15 bar (1,000 - 1,500 kPa).
2. Slowly build up test pressure to "X" bar.
3. Maintain initial test pressure "X" during the 30 minute adjustment period.
4. Perform a initial visual inspection on all joints and pipe work for leaks.
5. Slowly decrease the test pressure from the initial test pressure "X" bar to 5.5 bar (550 kPa).
6. Perform a second visual check.
7. Record pressure in the piping system after a test period of 2 hours.
If test pressure has fallen:
 - Repeat visual inspection of the installation, outlets and joints.
 - After resolving the cause of the drop in pressure, repeat steps 1 - 6.
8. Pressure test ends once no leaks are detected during visual inspection.

Completion of REHAU pressure test with water

1. Fill and sign pressure test protocol.
2. Detach the pressure test equipment.
3. Thoroughly flush and empty the drinking water pipes for hygiene purposes.
4. Reinstall all removed safety devices and meters.

In sub-zero conditions or if the drinking water installation is commissioned at a later stage, thoroughly drain all pipe work for hygienic reasons. Repeat flushing the pipe system before commissioning, or periodically if water stays in the pipe system for longer periods.

8.2 Purging and commissioning

Before commissioning the drinking water system, dirt from the construction phase has to be flushed out:

1. Open all outlets in sequential order and for several minutes.
2. If purging with drinking water alone is not efficient or if coarse dirt is visible in the piping system, it is recommended to purge the system alternating with water and pressurised air for several minutes or until all dirt has been flushed out.
3. If the drinking water system won't be operated immediately after commissioning, it is recommended to completely drain the drinking water lines for hygiene purpose. Purge the drained system thoroughly before recommissioning.
4. If water has to stay in the piping a long time before the system is put into operation, purging of the installation has to be periodically repeated for hygiene reasons.
5. In sub-zero conditions it is recommended to completely drain the drinking water lines to avoid freezing. Purge the drained system thoroughly before commissioning.



REHAU PINC™
Do what really matters

REHAU Pty Ltd – Melbourne Office

REHAU DesignHaus, 154 Moray St,
South Melbourne, Vic 3205
AUSTRALIA
Tel: 1300 844 595
Fax: 1300 760 665

REHAU Pty Ltd – National Customer Service Centre

Suite 1.02, Level 1, Quad 1, 8 Parkview Drive,
Sydney Olympic Park, NSW 2127
AUSTRALIA
Tel: 1300 768 033
Fax: 1300 760 665
Email: sales.au@rehau.com
www.rehau.com.au

REHAU Ltd – New Zealand

12 Allens Road, East Tamaki, Auckland 2013
NEW ZEALAND
Tel: +64 9 272 2264
Fax: +64 9 272 2265
Email: sales.nz@rehau.com
www.rehau.co.nz

