

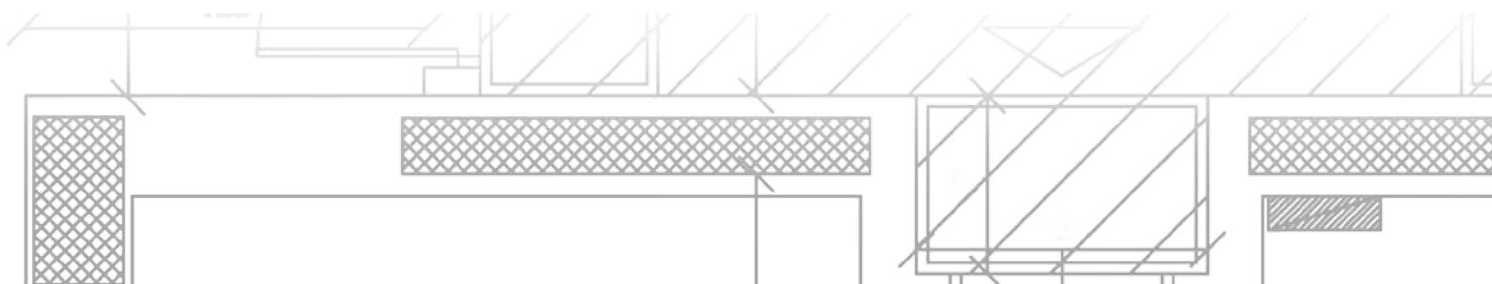

Technical Notebook

WATERPROOFING BATHS AND SWIMMING POOLS



Technical Notebook

**WATERPROOFING BATHS
AND SWIMMING POOLS**

page 02	1.	INTRODUCTION
page 02	2.	THE HISTORY OF SPA BATHS AND SWIMMING POOLS
page 03	3.	DESIGNING AND WATERPROOFING NEW HYDRAULIC STRUCTURES
page 04	3.1	REINFORCED CONCRETE BATHS AND POOLS: SPECIFICATIONS FOR CONCRETE
page 07	3.2	PROTECTING AND WATERPROOFING STRUCTURES
page 10	3.3	SEALING SECOND POURS, STRUCTURAL JOINTS, COMPONENTS FOR WATER CIRCULATION AND FILTRATION UNITS AND LIGHT FITTINGS
page 13	3.4	SUBSTRATE PREPARATION
page 14	3.5	WATERPROOFING THE INSIDE OF BATHS AND SWIMMING POOLS
page 16	4.	WATERPROOFING EXISTING STRUCTURES
page 16	4.1	PRELIMINARY ASSESSMENT
page 17	4.2	SUBSTRATE PREPARATION
page 18	4.3	SEALING LIGHT FITTINGS AND COMPONENTS FOR WATER CIRCULATION AND FILTRATION UNITS
page 20	4.4	LEVELLING AND WATERPROOFING SURFACES IN BATHS AND SWIMMING POOLS
page 21	5.	INSTALLING CERAMIC, STONE AND MOSAIC
page 21	5.1	INTERACTION BETWEEN LININGS AND REINFORCED CONCRETE
page 21	5.2	ADHESIVES FOR INSTALLING LININGS
page 21	5.2.1	RAPID REPAIR SYSTEM FOR SWIMMING POOLS
page 21	5.3	GROUTING JOINTS
page 21	5.3.1	HOW TO CHOOSE THE CORRECT GROUTING PRODUCT
page 21	5.3.2	CEMENTITIOUS GROUTS
page 21	5.3.2	EPOXY GROUTS
page 21	5.4	SEALING JOINTS
page 29	6.	FINISHING THE INSIDE OF BATHS AND SWIMMING POOLS WITH ACRYLIC PAINT

WATERPROOFING BATHS AND SWIMMING POOLS



1. INTRODUCTION

Reinforced concrete structures are often used in the construction of baths and swimming pools. Since they are often in permanent contact with the water contained in the bath or pool, as well as with water in the ground, they must be waterproofed and protected from aggressive agents that could potentially compromise their durability over the years.

The guidelines proposed in this manual present measures to be taken during the design phase of hydraulic structures and methods to be adopted to waterproof both new baths and swimming pools and existing structures in need of repair.

The aim of this document is to reduce problems caused by incorrect technical specifications during the design phase or due to errors or a lack of attention to detail during installation work.



2. THE HISTORY OF SPA BATHS AND SWIMMING POOLS

Since ancient times baths and swimming pools, that is, closed areas of water in general, have been used for various purposes (swimming pools, tanks for keeping or breeding fish, storage tanks for water, pools for medical purposes, etc.). We just have to remember that, as far back as prehistoric times, people were already immersing themselves in baths of hot water to reap the benefits of their curative and healing properties.

The practice of bathing in hot water and the construction of special bathing centres first became common in Ancient Greece thanks to the followers of Asclepius, the God of medicine and healing, who theorised the health benefits of water. The first known bath, however, the remains of which may still be visited today, is the Great Bath built around the III Millennium BC in Mohenjo-daro in what is today known as Pakistan.

The remains of the Siloam and Bethesda Baths discovered near Jerusalem, on the other hand, which were mentioned in the Gospel of St.

John, date back to the VII Century and III Century BC respectively. These baths were located near the Temple and historians believe they were used by worshippers to cleanse themselves before entering the Temple, as required by religious law at the time.

It was the Romans; however, who came up with the idea of “Thermal” baths (from the Greek word θερμὸς, which means hot, boiling) as places with bathing areas where people could enjoy the therapeutic and hygienic benefits of the water.

These thermal baths or spas, were places where people would meet and socialise. In fact, apart from having baths, changing rooms and gymnasiums, the most beautiful spas often had their own theatres and libraries. Small spas were also part of the more elegant homes.

Amongst the most well known spa structures still visible today are those in Caracalla (212-217 AD) and Diocletian (298-306 AD).

The fall of the Roman Empire, and the spread of Christianity, led to a decline in the use of spas, and it wasn't until Medieval times that spa baths became fashionable again, although only for therapeutic and hygienic purposes.

Since the 1800's until today, pools for swimming have also been constructed next to spa centres. These structures may now be found within sports complexes or even as a feature in private homes.



3. DESIGNING AND WATERPROOFING NEW HYDRAULIC STRUCTURES

As far as the construction of swimming pools is concerned, the most important aspect is normally the aesthetics of the pool such as its shape, size, the material used to line it, etc. When deciding to build a hydraulic structure, however, the most important and delicate aspect to take into consideration is the design of the structure itself. Unfortunately, errors and omissions during the design phase often lead to unpleasant

WATERPROOFING BATHS AND SWIMMING POOLS

consequences in terms of watertightness and durability of the structure over the years. If we were to summarise the most important points to take into consideration when designing a hydraulic structure they would be as follows:

- correct mix design;
- protection and waterproofing of the external parts of the structure;
- sealing second pours and components for water circulation and filtration units and light fittings;
- preparation and waterproofing of the internal surfaces of the pool;
- choosing the right materials to finish off the surfaces.

3.1 REINFORCED CONCRETE BATHS AND POOLS: SPECIFICATIONS FOR CONCRETE

As mentioned previously, one of the aspects to take into consideration when designing structures for swimming pools is the definition of the correct mix design of the poured concrete. In fact, as far as durability is concerned, concrete must be designed in accordance with EN 206-1:2006 standards, which takes into consideration the exposure class of the surroundings where the structure is located (Table 1). Then, depending

Exposure classes		
CLASS DENOMINATION	TYPE OF CONDITIONS AND SURROUNDINGS	EXAMPLES OF CONDITIONS AND SURROUNDINGS TO WHICH THE EXPOSURE CLASSES MAY BE APPLIED
1 No risk of corrosion or attack		
X0	Concrete with no metallic reinforcement or inserts: exposure to all types of conditions except freeze/thaw cycles, abrasion or chemical attack. Concrete with metallic reinforcement or inserts: very dry.	Concrete in buildings with very low humidity in the surrounding air
2 Corrosion induced by carbonation		
For concrete containing metallic reinforcement or inserts exposed to the air and humidity, exposure is classified as follows: <i>Note: the levels of humidity refer to those present in the concrete or material used to cover the steel reinforcement or metal inserts, although in most cases such conditions may be considered as the same as the surrounding environment. In such cases, the classification of the surroundings may be considered sufficient. This may not necessarily apply if there is a barrier between the concrete and its surroundings.</i>		
XC1	Dry or permanently wet	Concrete in buildings with low relative humidity Concrete permanently immersed in water
XC2	Wet, rarely dry	Concrete surfaces in contact with water for long periods of time Most foundations
XC3	Moderately damp	Concrete in buildings with a moderate or high level of relative humidity in the surrounding air Exposed concrete outdoors protected from rain
XC4	Cyclically wet and dry	Concrete surfaces subjected to contact with water not in exposure class XC2

3 Corrosion induced by chlorides except chlorides from seawater		
If concrete with metallic reinforcement or inserts is in contact with water containing chlorides not from seawater, including anti-freeze agents, exposure is classified as follows: <i>Note: refer to section 2 of this table for humidity conditions.</i>		
XD1	Moderately damp	Concrete surfaces exposed to saline mist
XD2	Wet, rarely dry	Swimming pools Concrete exposed to industrial water containing chlorides
XD3	Cyclically wet and dry	Parts of bridges exposed to spray containing chlorides Flooring Road surfaces in car parks
4 Corrosion induced by chlorides present in seawater		
If concrete containing metallic reinforcement or inserts is in contact with chlorides present in seawater, or with air carrying salts from seawater, exposure is classified as follows:		
XS1	Exposed to saline mist but not in direct contact with sea water	Structures on or close to the coast
XS2	Permanently submerged	Parts of marine structures
XS3	Zones exposed to waves or high tides	Parts of marine structures
5 Attack from freeze/thaw cycles with or without de-icing salts		
If wet concrete is exposed to significant attack due to freeze/thaw cycles, exposure is classified as follows:		
XF1	Modest saturation of water without anti-freeze agents	Vertical concrete surfaces exposed to rain and frost
XF2	Modest saturation of water with anti-freeze agents	Vertical concrete surfaces of road structures exposed to frost and mist with anti-freeze agents
XF3	High saturation of water without anti-freeze agents	Horizontal concrete surfaces exposed to rain and frost
XF4	High saturation of water with anti-freeze agents or with seawater	Bridge joists and road surfaces exposed to anti-freeze agents Concrete surfaces directly exposed to mist containing anti-freeze agents and frost
6 Chemical attack		
If concrete is exposed to attack from chemicals contained naturally in the ground or in the water in the ground with the characteristics defined in table 2, exposure is classified as follows. The classification of seawater depends on its geographical location. Apply the classification valid for the area where the concrete is used. <i>Note: a special study of the area may be required in the following cases to establish the exposure conditions to be applied:</i> <ul style="list-style-type: none"> - if the limits are not within those defined in table 2; - if there are other aggressive chemicals present; - if the ground or water are polluted by chemicals; - if there is a combination of fast flowing water and chemical substances contained in table 2. 		
XA1	Chemically weak aggressive surroundings according to table 2	
XA2	Chemically weak aggressive surroundings according to table 2	
XA3	Chemically weak aggressive surroundings according to table 2	

Table 1 - Taken from EN 206-1:2006 with indication of environmental exposure classes

WATERPROOFING BATHS AND SWIMMING POOLS

Recommended limit values for the composition and properties of concrete

	EXPOSURE CLASSES																		
	No risk of corrosion and/or attack	Corrosion due to carbonation					Corrosion due to chlorides						Attack by freeze/thaw cycles				Aggressive chemical environments		
							Sea water			Other chlorides (not from sea water)									
		X0	XC1	XC2	XC3	XC4	XS1	XS2	XS3	XD1	XD2	XD3	XF1	XF2	XF3	XF4	XA1	XA2	XA3
MAXIMUM WATER/CEMENT RATIO	-	0.65	0.60	0.55	0.50	0.50	0.45	0.45	0.55	0.55	0.45	0.55	0.55	0.50	0.45	0.55	0.50	0.45	
MINIMUM STRENGTH CLASS	C12/15	C20/25	C25/30	C30/37	C30/37	C30/37	C35/45	C35/45	C30/37	C30/37	C35/45	C30/37	C25/30	C30/37	C30/37	C30/37	C30/37	C35/45	
MINIMUM CEMENT CONTENT (KG/M ³)	-	260	280	280	300	300	320	340	300	300	320	300	300	320	340	300	320	360	
MINIMUM AIR CONTENT (%)	-	-	-	-	-	-	-	-	-	-	-	-	4.0 ^{a)}	4.0 ^{a)}	4.0 ^{a)}	-	-	-	
OTHER REQUIREMENTS												Aggregates in compliance with EN 12620 with sufficient resistance to freeze/thaw cycles				Cement resistant to sulphates ^{b)}			
<p>a) When the concrete does not contain added air, its performance must be verified by means of a standard test method compared with a type of concrete with proven resistance to freeze/thaw cycles for the relative exposure class.</p> <p>b) If the presence of SO₂ puts it in exposure classes XA2 and XA3, it is essential to use a type of cement resistant to sulphates. If the cement is classified as having moderate or high resistance to sulphates, it must be used in exposure class XA2 (and in exposure class XA1 if applicable) and cement with high resistance to sulphates must be used in exposure class XA3.</p>																			

Table 2 - From EN 206-1: 2006 with indications of limit values for the composition and properties of concrete

on the exposure class, the limit values for the composition and properties of the concrete are specified (maximum water/cement ratio, minimum strength class and minimum cement content) (Table 2).

Also, a good concrete mix with a coefficient of permeability (k) lower or equal to 1x10⁻¹¹ m/s, and resistance to the penetration of water of up to 50 mm and an average of up to 20 mm (in compliance with EN 12390-8 standards), may be considered theoretically impermeable. However, under real conditions, it is very difficult to mix concrete with a perfect structure throughout its entire mass, in that shrinkage during the curing phase, settling of the foundations and small irregularities generate cracks that form a preferential passage for water.

To overcome this problem, MAPEI recommends using a super-plasticising

admixture from the DYNAMON range. The DYNAMON system is based on DPP (Designed Performance Polymer) technology, a new chemical process which, through total monomer design (know-how exclusive to MAPEI), allows the characteristics of the admixture to be modulated according to the specific performance requirements of the concrete employed. Concrete made with products from the DYNAMON range is easy to apply while fresh and offers very high mechanical performance when hardened.



3.2 PROTECTING AND WATERPROOFING STRUCTURES

Even if concrete is well made it will still need to be protected from “aggressive agents” that would otherwise accelerate deterioration of the element or structure and so reduce its durability over the years. Water from the ground, as with the water in a bath or pool, is naturally aggressive and, if it penetrates into the concrete, will weaken the structure. During the design phase, therefore, another very important aspect to be taken into consideration is the height of the water table (constant or temporary) in the area in which the structure is built. Once this evaluation has been carried out, it will be possible to define both the most suitable type of foundation and the most appropriate waterproofing system.

MAPEI has a wide range of waterproofing products available to guarantee protection of the structure, as well as being waterproof.

When building hydraulic structures below ground level, where there is ground water, we recommend waterproofing the structure using MAPEPROOF or MAPEPROOF LW bentonite sheets. These sheets are composed of two layers of polypropylene geo-textile fabric needle-punched together with a uniform layer of natural sodium bentonite sandwiched between the two layers. One of the properties of bentonite is that it expands upon contact with damp and moisture to form a seamless, impermeable, protective layer that completely adheres to the structure. MAPEPROOF bentonite sheets may be used to waterproof horizontal surfaces before pouring concrete and vertical walls after pouring.

Below is a brief description of how to apply these products.

WATERPROOFING BATHS AND SWIMMING POOLS

- Waterproofing below foundation slabs prior to pouring

After fastening the formwork around the perimeter, roll out sheets of MAPEPROOF with the lower geo-textile fabric (dark side) against the inner edges and the regulating layer of concrete used to level off the surface of the ground underneath. When rolling out the sheets, overlap the edges of each sheet by 10 cm and fasten them in place with MAPEPROOF CD nails and polyethylene washers approximately every 30 cm (Fig. 3.1).

Position the reinforcement for the concrete and cast the foundation slab. Once the foundation slab is fully cured, pour the concrete for the side walls making sure that second pours are sealed with beads of hydro-expansive material, as described in the next section.

- Waterproofing side walls after pouring

Once the concrete for the side walls has been poured and has fully cured, level off any uneven or irregular areas in the substrate with products from the MAPEGROUT or PLANITOP range by MAPEI.

The top of the walls must be treated with a 50 cm wide band of MAPELASTIC FOUNDATION.

Then roll out the MAPEPROOF sheets with the upper side of the geo-textile fabric (white non-woven fabric) against the reinforced concrete wall and fasten the sheets in place with MAPEPROOF CD every 50 cm (Fig. 3.2).

In order to ensure a continuous, perfect waterproofing layer, the sheets must be overlapped at the foot of the structure with the waterproofing layer underneath the foundation slab (Fig. 3.3).

Once the vertical walls have been waterproofed, apply a layer of 250 g/m² non-woven fabric to protect the waterproofing system when back filling.



Fig. 3.1 - Waterproofing system under a foundation slab before pouring the concrete



Fig. 3.3 - Waterproofing treatment along the base of the structure

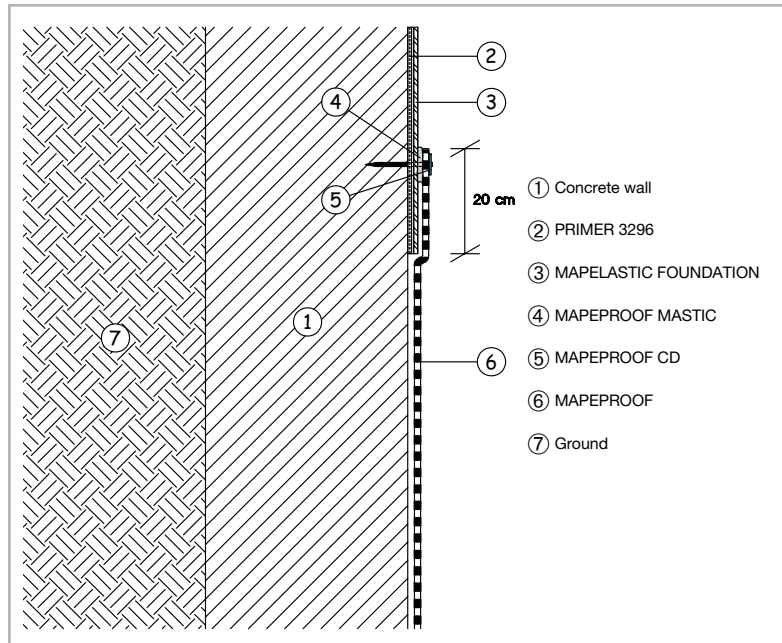



Fig. 3.2 - MAPELASTIC FOUNDATION and MAPEPROOF overlapped and hemmed to waterproof a vertical wall after pouring concrete

The walls may also be waterproofed after pouring with MAPELASTIC FOUNDATION, two-component, elastic cementitious mortar specific for waterproofing concrete subjected to negative and positive hydraulic lift (up to 1.5 atm. or a 15 metre head of water). Before applying MAPELASTIC FOUNDATION we recommend cleaning the surfaces thoroughly, taking particular care to remove all traces of form-release oils, dirt and any material or substance that could affect adhesion of the waterproofing product. The ribs from the formwork must be broken off and grouted with ADESILEX PG4 two-component, thixotropic epoxy adhesive. While the adhesive is still wet, dust the surface with quartz sand to create a surface that is rough enough to guarantee a good grip for the next waterproofing system. Also, any peaks must be removed and then smoothed over by applying a product from the MAPEGROUT or PLANITOP range. Once this layer is fully cured, and before applying MAPELASTIC FOUNDATION, prime the surface with PRIMER 3296 acrylic, dust-repellent consolidating primer in water dispersion to

WATERPROOFING BATHS AND SWIMMING POOLS

improve its adhesion to the substrate. Dilute the primer 1:1 with water and apply with a brush or roller.

After preparing the substrates as specified, apply a layer of MAPELASTIC FOUNDATION minimum 2 mm thick with a brush, roller or by spray.



3.3 SEALING SECOND POURS, STRUCTURAL JOINTS, COMPONENTS FOR WATER CIRCULATION AND FILTRATION UNITS AND LIGHT FITTINGS

Another important aspect to take into consideration during the design phase of a swimming pool is how to seal any breaks in the surfaces that could potentially provide a preferential passage for water, such as:

- second pours;
- structural joints;
- pipe work;
- components for water recirculation units;
- light fittings.

MAPEI has a series of products available that have been specifically developed to overcome this type of problem, such as IDROSTOP, IDROSTOP B25 and IDROSTOP SOFT, pre-formed hydro-expansive tape, which is used to seal second pours and the interface between through elements and concrete.

IDROSTOP is an acrylic polymer-based hydro-expanding jointing product, used preferably in the presence of salt water. For fresh water, on the other hand, it is better to use IDROSTOP B25 and IDROSTOP SOFT. These are also hydro-expansive products, the first made from a mixture of natural sodium bentonite and polymers and the latter from a mixture of natural sodium bentonite and butyl rubber.

When these jointing materials come into contact with water they expand and, thanks to this special characteristic, are able to form a seal in second pours, small localised gravel clusters and gaps that form between a through penetration element and the poured concrete. Below are typical application examples for IDROSTOP SOFT and IDROSTOP B25.

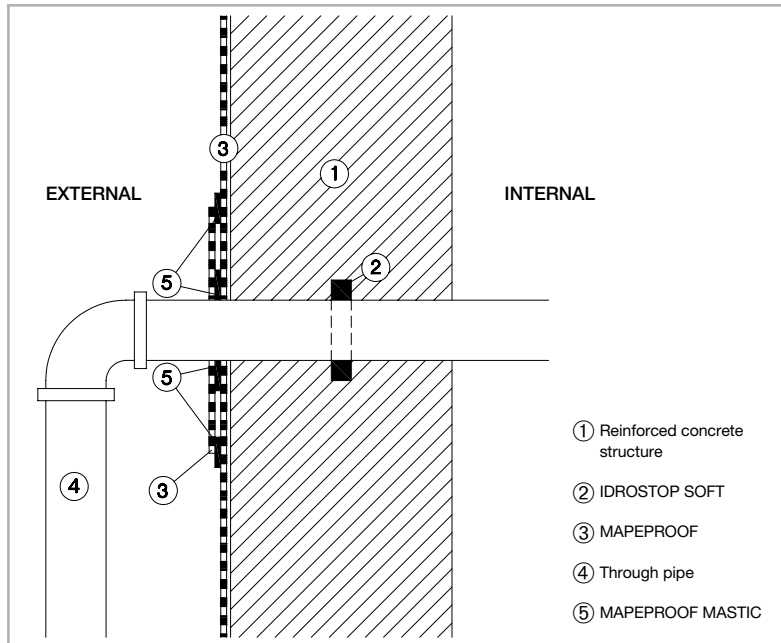

Fig. 3.4 - An example of how to seal a through pipe with a ring of IDROSTOP SOFT bonded with ULTRABOND MS RAPID and MAPEPROOF bentonite sheet trimmed to the shape of the pipe

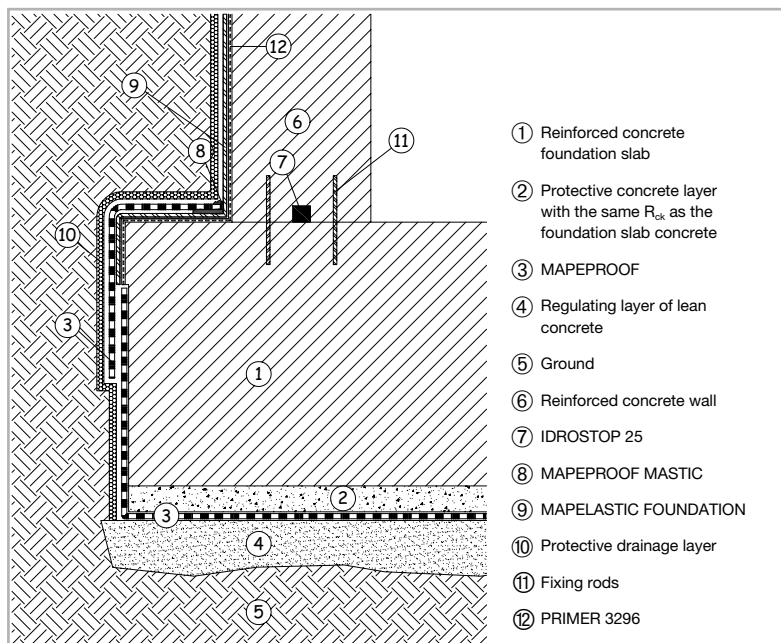

Fig. 3.5 - An example of how to seal a second pour by fastening a bead of IDROSTOP B25 with nails at the mid-point of the poured concrete

WATERPROOFING BATHS AND SWIMMING POOLS

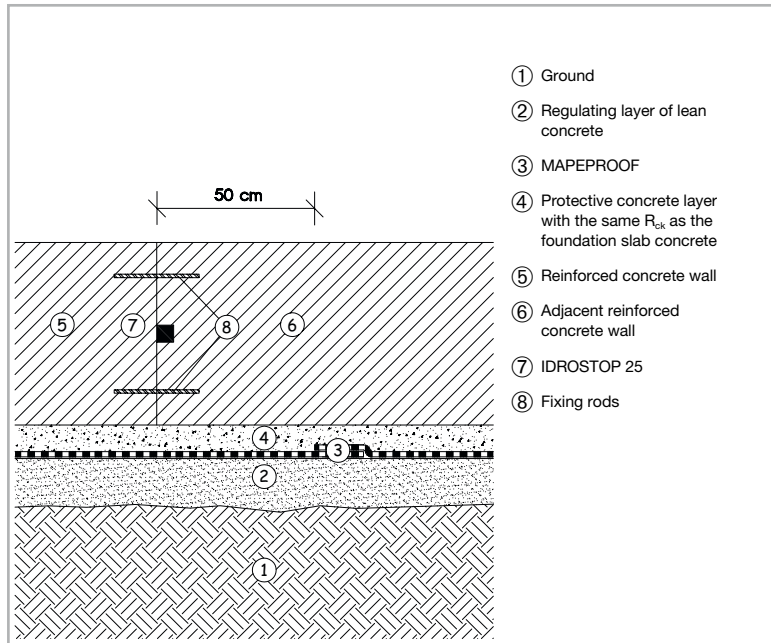

Fig. 3.6 - An example of how to seal a second pour by fastening a bead of IDROSTOP B25 in place with nails at the mid-point of the poured concrete

If structural joints need to be included during the design phase, they may be waterproofed by following the procedure in the box below.

STRUCTURAL JOINTS:

Waterproof the joints by placing **MAPEBAND TPE** tape (an acronym for Thermo-Plastic Elastomer) along the joints. The tape is 1 mm thick with edges reinforced with polyester fabric and must be bonded in place as follows:

- apply an even layer of **ADESILEX PG4**;
- apply **MAPEBAND TPE** by pressing it lightly along the edges;
- apply a second layer of **ADESILEX PG4** wet on wet to completely cover the strip of fabric and dust the surface of the product while still wet with 0.5 mm spheroid quartz sand;
- once **ADESILEX PG4** has fully hardened, remove any loose quartz and apply **MAPELASTIC FOUNDATION** or **MAPELASTIC SMART**.



Fig. 3.7 - Applying a coat of Eporip on components for a water recirculation unit



Particular attention must also be paid during the design phase to light fittings and components used for water circulation units, such as skimmers.

These components must be placed in position before pouring the concrete.

To make sure the interface between the components and the poured concrete is completely sealed, MAPEI recommends applying EPORIP two-component, solvent-free epoxy adhesive on the components and then dusting them with quartz sand to make sure there is a good grip between the component and the next pour of concrete (Fig 3.7).

3.4 SUBSTRATE PREPARATION

Once the structure of the swimming pool has been completed and the external surfaces have been waterproofed, the next phase is to prepare and even out the internal horizontal and vertical substrates.

Before carrying out any further operation, the first thing to do is clean all the surfaces by high pressure hydro-blasting to remove surface bleeding and traces of form-release compounds. It is important that the substrates are clean and have no loose parts, traces of dust, residues from previous operations or any other product or substance that could impede good adhesion of the next products to be applied. Once the substrates have been prepared, level off the bottom of the pool by installing a compact, bonded screed sufficiently strong for the waterproofing system and lining material for the pool.

Apply a layer of bonding slurry on the bottom of the pool made from PLANICRETE mixed with water and the same binder used to make the screed in the following proportions: PLANICRETE 250 g, water 250 g and TOPCEM 3 kg. Using the wet on wet technique, apply the screed made from TOPCEM, cementitious binder for normal-setting, quick-drying, controlled-shrinkage screeds or TOPCEM PRONTO, ready-mixed mortar for normal-setting, quick-drying (4 hours), controlled-shrinkage screeds, class CT-C30-F6-A1fl according to EN 13813.

WATERPROOFING BATHS AND SWIMMING POOLS

To even out the vertical surfaces, on the other hand, use a levelling mortar such as NIVOPLAN admixed with synthetic latex rubber, such as PLANICRETE, or, as an alternative, PLANITOP FAST 330, fibre-reinforced, rapid-setting, cementitious levelling mortar applied in layers from 3 to 30 mm thick for levelling off uneven or irregular substrates.

3.5 WATERPROOFING THE INSIDE OF BATHS AND SWIMMING POOLS

Once the screed and levelling layers on the vertical surfaces are fully cured, and after making sure all the substrates are clean and dry, the next step is to waterproof slopes, fillets and breaks in the surfaces according to the procedure in the box below.

SLOPES, FILLETS AND BREAKS IN THE SURFACE:

During the construction phase of the structure, the critical points to seal and waterproof are breaks in the surfaces made by slopes, access ladders and fillets between adjacent surfaces (horizontal and vertical surfaces and between adjacent walls).

MAPEI recommends **MAPEBAND**, alkali-resistant, felt-backed rubber tape for these operations, which is applied using **MAPELASTIC** or **MAPELASTIC SMART** (depending on which product is chosen to waterproof the pool).

- apply an even layer of **MAPELASTIC** or **MAPELASTIC SMART**;
- apply **MAPEBAND TPE** by pressing it lightly along the edges;
- apply a second layer of the waterproofing product wet on wet to completely cover the sides of the tape (Fig. 3.8).

We recommend using special shaped pieces of MAPEBAND for corners, edges and cross points: ANGLE 90° and ANGLE 270°, CROSS and “T”.

Use **ADESILEX LP** for the joints between adjacent strips and between strips and shaped pieces of **MAPEBAND**.

If mosaic is to be used to line the pool once work has been completed, we recommend forming 10 cm shells around the fillets as follows to make installation of the mosaic easier:

- apply **EPORIP** along the edges and corners;
- form shells applied wet on wet made from **MAPEGROUT 430** or a similar product from the **MAPEGROUT** range.



Fig 3.8 - Sealing and waterproofing fillets between a horizontal and vertical surface with MAPEBAND



Fig. 3.9 - Waterproofing treatment with MAPELASTIC SMART and MAPETEX SEL



Fig. 3.10 - Waterproofing treatment with MAPELASTIC SMART and MAPETEX SEL

The waterproofing product must only be applied once all the breaks in the surface have been waterproofed.

MAPEI recommends two-component, elastic cementitious mortar for waterproofing hydraulic structures, such as: MAPELASTIC or MAPELASTIC SMART.

The main characteristics of these two products are:

- excellent adhesion;
- high elasticity which is maintained over the years;
- excellent crack-bridging capacity;
- good workability;
- easy to apply.

The choice of whether to use MAPELASTIC rather than MAPELASTIC SMART depends on where the bath or pool is constructed. We recommend using MAPELASTIC for waterproofing pools with the structure below ground level. If the structure is built above ground, on the other hand (such as covered or indoor pools), in order to withstand any movements in the whole structure, we recommend using MAPELASTIC SMART.

Substrates must be clean and dry before applying MAPELASTIC. Spread two layers of the product with a smooth or notched trowel to form a layer with a total thickness of at least 2 mm, with MAPENET 150 alkali-resistant glass fibre mesh embedded between the layers to increase its flexibility and guarantee its crack-bridging capacity for cracks up to 1.5 mm wide.

If a more fluid product that is easier to apply with a roller or brush is preferred, we recommend using MAPELASTIC SMART. This must also be applied to form a layer at least 2 mm thick, but in this case place MAPETEX SEL perforated non-woven polypropylene fabric in the product and press it down with a flat trowel to make sure it is completely embedded. When MAPELASTIC SMART is used in combination with MAPETEX SEL, it follows the movements of structures and has a crack-bridging capacity of more than 3 mm.

Apply the second coat of MAPELASTIC or MAPELASTIC SMART around

WATERPROOFING BATHS AND SWIMMING POOLS

6 hours after the first one, and in all cases only when the first coat has completely dried.

Once the waterproofing layer is completely dry (4-5 days), the tiling material may be installed.

Depending on which type of material is used to tile the bath or pool (ceramic, stone or mosaic), MAPEI has a suitable product available for bonding and grouting the material.

To choose the most suitable product, refer to sections 5 and 6 of this technical notebook.



4. WATERPROOFING EXISTING STRUCTURES

Up to this point of the manual we have only taken into consideration how to protect and waterproof new structures. Very often, however, problems are encountered with the impermeability of existing structures for which, during the design phase, a waterproofing system had not been included. In other cases, on the other hand, repair work must be carried out on a waterproofing system that has already been applied but is no longer watertight.

For repair work, as with new builds, there are certain fundamental points to be taken into consideration, such as:

- a preliminary assessment of the substrates;
- preparation of the surfaces;
- sealing light fittings and components for water circulation and filtration units;
- levelling and waterproofing baths and pools;
- choosing the right materials to finish off the surfaces.



4.1 PRELIMINARY ASSESSMENT

Before installing onto existing structures a thorough, preliminary assessment must be carried out to identify the condition and strength of the structure and the flatness of the substrates on which work is to



Fig. 4.1 - Applying a coat of MAPEFER 1K on reinforcing bars

be executed. This operation is extremely important in that it enables the surveyor to define the most suitable method to restore the soundness of the substrates and to identify the most suitable operations and products to waterproof the structure.

4.2 SUBSTRATE PREPARATION

As with new builds, the first operation is to prepare the substrates correctly. Before carrying out this operation the existing lining material, whether it is ceramic, PVC or another type of material, must be completely removed. Once the lining has been completely removed it will then be possible to check the condition of the substrates and, as a result, restore them to a monolithic state. If there are cracks in the screed, for example, they must be sealed. Open the cracks (with a hand-grinder for example) and, after removing all traces of dust, seal them by filling them with EPORIP dusted with quartz sand while still wet to create a surface with a good grip. If reinforcing bars are exposed on the vertical surfaces, we recommend following the procedure in the box below.

EXPOSED REINFORCING BARS:

After removing the existing lining material from inside the pool and hydro-blasting the substrates, it will probably be necessary to coat exposed reinforcing bars.

- demolish the layer of deteriorated concrete to fully expose the reinforcing bars;
- clean the rust from the reinforcing bars;
- apply a coat of **MAPEFER 1K**, one-component, anti-corrosion cementitious mortar;
- reinstate the areas where the concrete has been removed with **MAPEGROUT 430**, medium-strength, fibre-reinforced, compensated-shrinkage, fine-grained cementitious mortar mixed with 0.25% of **MAPECURE SRA** curing agent with the capacity to reduce hydraulic shrinkage and the formation of hair-line cracks.

WATERPROOFING BATHS AND SWIMMING POOLS

Another operation that needs to be carried out before applying the waterproofing system is to seal the second pours and fillet joints between horizontal and vertical surfaces and between adjacent walls. To carry out this operation follow the procedure in section 4.3 for sealing through pipes.

All the surfaces must then be thoroughly cleaned as described in section 3.4, which discusses the preparation of substrates in new builds.

4.3 SEALING LIGHT FITTINGS AND COMPONENTS FOR WATER CIRCULATION AND FILTRATION UNITS

The risk of an element or component passing through the structure of a swimming pool forming a preferential passage for water is just as high in new builds as in pools under repair. That is why it is very important that any breaks between these elements or components and the reinforced concrete are sealed.

The following drawings illustrate how to seal components for water circulation and filtration units and light fittings correctly.

- make a groove around the through element (6 cm deep);
- remove all traces of dust from the groove;
- extrude a bead of MAPEPROOF SWELL, one-component hydro-expanding paste for waterproof seals in the bottom of the groove (Fig. 4.2);
- apply a coat of EPORIP, two-component, solvent-free epoxy adhesive on the surface of the groove;
- reinstate the substrate with MAPEGROUT 430, fine-grained, fibre-reinforced, compensated-shrinkage thixotropic mortar (Fig. 4.3).



Fig. 4.2 - Forming a seal with MAPEPROOF SWELL



Fig. 4.3 - Reintegrating a substrate with MAPEGROUT 430

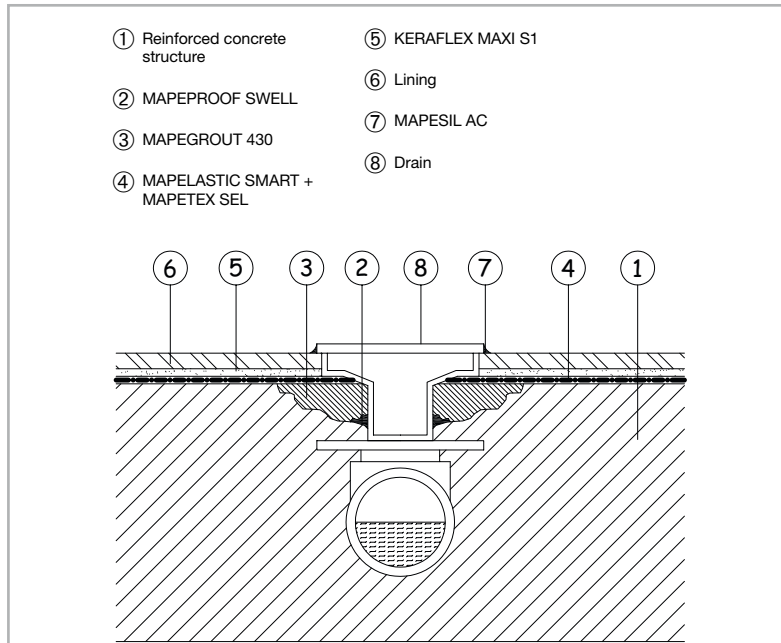

Fig 4.4 - An example of how to seal a water recirculation outlet on the bottom of a swimming pool

Another critical point to take into consideration before applying the waterproofing product is the anchor points for ladders and handrails.

To ensure a continuous waterproofing layer, we recommend drilling the holes and inserting the clamps for the ladders and handrails and then using MAPEFIX VE SF styrene-free, polyester resin-based chemical anchor for heavy loads.

Once all the anchor points are in place, sand all the metallic fittings to remove traces of loose material or material which is not well bonded and apply a coat of EPORIP, two-component, solvent-free epoxy adhesive.

While the resin is still wet, dust the surface with quartz sand to create a surface that is rough enough to help adhesion of the elastic, cementitious waterproofing mortar to be applied later.

WATERPROOFING BATHS AND SWIMMING POOLS

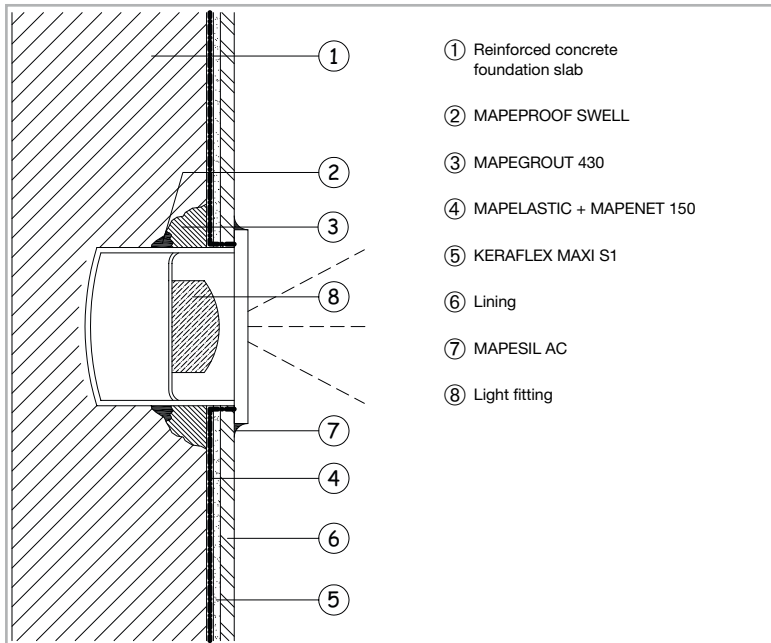

Fig. 4.6 - An example of how to seal a light fitting on the side of a swimming pool

4.4 LEVELLING AND WATERPROOFING SURFACES IN BATHS AND SWIMMING POOLS

Once all the critical points have been sealed, level off all the horizontal and vertical surfaces so they are flat and ready for the waterproofing product.

The operations to carry out are as follows:

1. level off the bottom of the bath or pool and install a screed bonded to the structure;
2. level off the vertical walls;
3. seal and waterproof the fillet joints between breaks in the surface and slopes;
4. waterproof all the surfaces.

To carry out all these operations correctly follow the procedure described in sections 3.4 and 3.5.



Fig. 4.5 - Styrene-free, vinyl ester resin-based chemical anchor for heavy loads



5. INSTALLING CERAMIC, STONE AND MOSAIC

To ensure the durability over the years of structures permanently in contact with water, such as baths and swimming pools, or structures that are exposed to moist or damp surroundings such as in spa centres, we recommend tiling them with ceramic, stone or mosaic once they have been waterproofed with MAPELASTIC or MAPELASTIC SMART.

When choosing which type of material to use, it is very important to take into consideration that it must be able to resist the chemical and mechanical stresses to which structures permanently immersed in water are exposed. MAPEI has a wide range of adhesives available to bond tiles in place. These products, together with their application techniques, are described below.



5.1 INTERACTION BETWEEN LININGS AND REINFORCED CONCRETE

The load-bearing structure of a swimming pool and the material used to line the pool form an integrated system that is subjected to various types of stress, such as hydrostatic pressure (which is amplified when the pool is emptied), temperature variations, shrinkage of the reinforced concrete structure, settling of the ground, etc.

Variations in the interaction between the lining and the structure of the bath or pool are the main cause of their deterioration (Fig. 5.1).

The installation system, therefore, plays a fundamental role in absorbing the differential strains and stresses that are generated between the various layers.

It is important, therefore, that the right material is chosen to ensure the lining to guarantee its durability and reduce the frequency of maintenance or repairs.



Fig. 5.1 - Tiles detached from a substrate due to compressive stresses

WATERPROOFING BATHS AND SWIMMING POOLS

We recommend using a deformable or highly deformable adhesive over the waterproofing layer, depending on the format of tile used (see section 5.2). A certain amount of deformability is required because the adhesive must be able to absorb the deformations that the lining material has to withstand.

5.2 ADHESIVES FOR INSTALLING LININGS

Before installing the lining, we suggest checking that the waterproofed bath or pool is watertight. Once MAPELASTIC or MAPELASTIC SMART is fully cured, fill the bath or pool with water.

Once the watertightness and, therefore, the correct application of the waterproofing material have been checked, drain off all the water and install the lining material.

MAPEI has a wide range of products available to install lining material in baths and pools, and the choice of which product to use depends on various factors, such as:

- the format and type of material to be installed;
- the weather conditions when the material is installed;
- the schedule before the bath or pool is put into service.
- the chemical and mechanical stresses when the bath or pool are in service.

Adhesives used to install linings in baths and pools must meet the following requirements (in compliance with EN 12004) (Figs. 5.2 - 5.3 - 5.4):

- class C2 to guarantee high adhesion strength to non-absorbent substrates, including when immersed permanently in water;
- class S1 or S2, which means deformable or highly deformable respectively, so that it matches the deformability characteristics of the waterproofed substrate and withstands the mechanical or thermal stresses to which the bath or pool is subjected.



Fig. 5.2 - Bonding tiles to a wall with KERABOND mixed with ISOLASTIC



Fig. 5.3 - Installing the lining on the bottom of a swimming pool



Fig. 5.4 - Installing a mosaic lining

UNI 11493 (Ceramic floor and wall tiles: design, installation and maintenance instructions) gives detailed indications on lining materials and installation techniques.

As far as swimming pools are concerned, section §7.13.3 of the standard states that, in order to improve durability, it is necessary to ensure that the layer of adhesive is compact by installing the material correctly, that is, by using the double-buttering technique. This technique consists in applying the adhesive on both the substrate and the back of the tile to prevent the formation of gaps in the layer of adhesive.

As far as the lining material is concerned, it is important to check that it is suitable for permanent immersion (section §7.4.2) and that it is compatible with the adhesive used.

Based on these indications, the following table summarises the adhesives to use according to the type of tile and the installation conditions:

NORMAL-SETTING ADHESIVES: baths and pools may be filled after 21 days		
Adhesive	Classification according to EN 12004	Characteristics
KERAFLEX MAXI S1	C2 TE S1	High-performance deformable cementitious adhesive with no vertical slip, extended open time and Low Dust technology
ULTRALITE S1	C2 TE S1	One-component high-performance deformable cementitious adhesive with no vertical slip, extended open time, Low Dust technology, very high yield and good trowellability
ADESILEX P10 mixed with ISOLASTIC diluted 1:1 with water	C2 E S1	Deformable cementitious adhesive system characterised by its bright white colour, specifically developed for installing mosaics
KERACRETE + KERACRETE POWDER	C2 T	Synthetic latex rubber mixed with KERACRETE POWDER (white or grey)
KERABOND mixed with ISOLASTIC	C2 E S2	Two-component highly deformable cementitious adhesive system with extended open time
KERABOND mixed with ISOLASTIC diluted 1:1 with water	C2 E S1	Two-component deformable cementitious adhesive system with extended open time

WATERPROOFING BATHS AND SWIMMING POOLS

5.2.1 RAPID REPAIR SYSTEM FOR SWIMMING POOLS

Thanks to MAPEI's long experience in building swimming pools, a complete installation system has been developed so that swimming pools can be put into service quickly.

The system includes a complete line of products to level, even out and create substrates, waterproofing mortars to guarantee the watertightness of structures, adhesives to install ceramic and glass mosaic tiling, special mortars to grout linings and sealants to seal expansion joints.

The following products in particular are worth a mention:

- PLANITOP FAST 330 rapid-setting, fibre-reinforced cementitious mortar for levelling off surfaces in layers from 3 to 30 mm thick. MAPELASTIC or MAPELASTIC SMART can then be applied over PLANITOP FAST 330 after just 24 hours;
- TOPCEM PRONTO and MAPECEM PRONTO, normal-setting and rapid-setting cementitious mortars respectively, used to make screeds for the bottom of swimming pools;
- MAPELASTIC and MAPELASTIC SMART, flexible cementitious waterproofing systems for perfect waterproofing work;
- GRANIRAPID and ELASTORAPID for rapid installation of ceramic tiles and glass mosaics;
- ULTRACOLOR PLUS rapid grouting mortar (available in 30 different colours);
- MAPESIL AC acetic silicone sealant for sealing expansion joints available in the same range of colours as ULTRACOLOR PLUS.

Linings for swimming pools installed using the products above may be filled with water, and so be ready for use, within as little as 48 hours of applying ULTRACOLOR PLUS and within just 3 days of installing the tiling.

RAPID-SETTING ADHESIVES:

baths and pools may be filled after 3 days

Adhesive	Classification according to EN 12004	Characteristics
GRANIRAPID	C2 F S1	Two-component high-performance deformable rapid-setting and hydrating cementitious adhesive
ELASTORAPID	C2 FTE S2	Two-component high-performance highly-deformable rapid-setting and hydrating cementitious adhesive with extended open time and no vertical slip
ULTRALITE S1 QUICK	C2 FT S1	One-component high-performance deformable rapid-setting and hydrating deformable lightweight cementitious adhesive with no vertical slip, high wetting capacity, very high yield and good trowellability

To install and grout linings in environments subjected to aggressive chemical agents and to protect the waterproofing system and, as a result, the concrete itself, we recommend using reactive epoxy adhesives classified R2 according to EN 12004, such as KERAPOXY or KERAPOXY DESIGN. These products may also be used where the lining is fibreglass.

5.3 GROUTING JOINTS

When installing the tiling the joint between each tile must be the right size, as indicated in UNI 11493 (butted tiles are not permitted). Joints are not just for decorative purposes; they are required to reduce the rigidity of the lining and make it more resistant to deformations.

It is important to state that, no matter what material a grouting product is made from, it cannot be considered a substitute for a complete, continuous substrate waterproofing system made from MAPELASTIC or MAPELASTIC SMART.

In fact, in a swimming pool, since cementitious grout is porous, a certain amount of water will always tend to penetrate through it, and even epoxy grout, albeit completely non-absorbent and impermeable, cannot guarantee that a lining is completely leak-proof when it is subjected to the stresses it has to withstand under normal conditions.

WATERPROOFING BATHS AND SWIMMING POOLS

5.3.1 HOW TO CHOOSE THE CORRECT GROUTING PRODUCT

Grouting materials are divided into two main categories according to EN 13888, depending on their chemical nature; CG stands for cementitious grouts while RG stands for reactive grouts.

The most suitable product must be chosen on the basis of the following:

- the type of water in the bath or pool;
- the schedule before the bath or pool is put into service;
- the type and frequency of sanitation treatments; certain treatments may have an influence on the durability of the grout.



Fig. 5.5 - Grouting the lining with ULTRACOLOR PLUS

5.3.2 CEMENTITIOUS GROUTS

Cementitious products are the type most commonly used to grout joints.

In compliance with the classification of grouts defined in EN 13888, we recommend using products from class CG2 (improved cementitious grouts) and class WA, that is, reduced water absorption and high resistance to abrasion (Fig. 5.5).

MAPEI products in these categories are shown in the following table:



Fig. 5.6 - Grouting the lining with KERAPOXY CQ

CEMENTITIOUS GROUTS:			
Product		Classification according to EN 13888	Characteristics
ULTRACOLOR PLUS		CG2 WA	<p>High-performance polymer-modified mortar for grouting joints from 2 to 20 mm wide</p> <p>With BioBlock® technology (resistant to the formation of mould) to impede the formation and proliferation of various types of mould on the surface of grout in damp conditions to safeguard the hygiene of the environment and, obviously, its final appearance and finish</p> <p>Anti-efflorescence</p> <p>With DropEffect® technology (high water repellence capacity) to guarantee high colour stability and excellent cleanability</p> <p>Rapid-setting; baths and pools may be filled 48 hours after grouting</p> <p>Available in 30 colours</p>
KERACOLOR GG	FUGOLASTIC	CG2 WA	<p>Cementitious mortar mixed with FUGOLASTIC to increase strength and resistance to abrasion and reduce porosity and water absorption</p> <p>With DropEffect® technology (high water repellence capacity) to guarantee high colour stability and excellent cleanability</p> <p>Available in 17 colours</p>
KERACOLOR FF			



Fig. 5.7 - Cleaning the surface of the lining with a Scotch-Brite® pad



Fig. 5.8 - Final cleaning operation with a clean sponge

5.3.3 EPOXY GROUTS

Thanks to their high strength and high resistance to chemicals, epoxy grouts, classified RG according to EN 13888, are generally more durable compared with traditional cementitious grouts.

That is why they are to be preferred in the following cases:

- swimming pools where sanitation treatments are carried out frequently with chlorinated water, pH regulators, anti-mildew treatments, etc.;
- thermal spa baths and baths or pools with salt water;
- applications that require high resistance to chemical products that could be potentially aggressive to cementitious products;
- total impermeability of joints to help protect substrates;
- high strength or high adhesion.

Thanks to these characteristics, epoxy products reduce the frequency of regular and unplanned maintenance operations compared with cementitious products (Figs. 5.6 - 5.7 - 5.8).

The epoxy grouting products proposed by MAPEI are summarised in the following table:

EPOXY GROUTS:		
Product	Classification according to EN 12004	Characteristics
KERAPOXY CQ	RG R2	Two-component anti-acid adhesive and filler Excellent workability Easy to clean Available in 21 colours
KERAPOXY DESIGN	R2 RG	Two-component anti-acid adhesive and filler Highly attractive finish, ideal for glass mosaics with a translucent effect Available in 24 colours and translucent effect Excellent workability and easy to clean
KERAPOXY	R2T RG	Two-component anti-acid adhesive and filler Available in 23 colours

WATERPROOFING BATHS AND SWIMMING POOLS



5.4 SEALING JOINTS

To complete a correct installation system, it is important to include elastic seals in conjunction with expansion joints, edges, corners, slopes and fillet joints between walls and floors using MAPESIL AC, a solvent-free, acetic-hardening silicone sealant with low modulus of elasticity and mould-resistant BioBlock® technology, available in 30 different colours.

This sealant also offers excellent resistance when permanently immersed in water and to the action of sanitation products normally used in public and private swimming pools.

To guarantee the adhesion of the sealant around tiles, PRIMER FD one-component primer for silicone and hybrid sealants must be applied beforehand.

As a rule, sealing must be carried out according to the indications in the table below:

How to regulate the depth of an elastic joint

a - width of joint

b - depth of joint

from 0 to 4 [mm]

increase the width of the joint

from 5 to 9 [mm]

$b = a$

from 10 to 20 [mm]

$b = 10$ [mm]

from 21 to 40 [mm]

$b = a/2$ [mm]

more than 40 [mm]

reduce the width of the joint

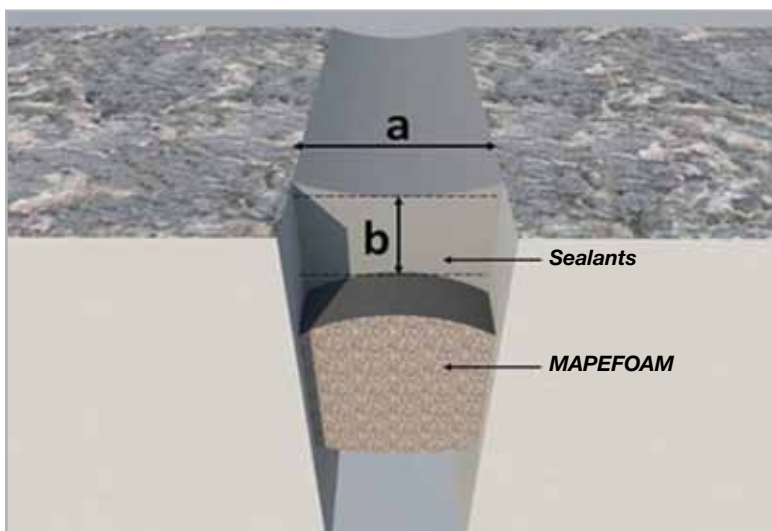

The width of an elastic joint must be defined according to the compressive and tensile stresses acting on the lining material.

To regulate the depth of the sealant (according to the indications in the table above) and avoid it sticking to the bottom of the joint, insert MAPEFOAM closed-cell polyethylene cord in the joint by pressing it lightly in place with the tip of a trowel or a wooden slat.

If there are expansion joints, to prevent the sealant adhering to the substrate, insert a non-adherent material between the waterproofed substrate and the sealant.

GENERAL GUIDELINES FOR SWIMMING POOL MAINTENANCE

If a swimming pool is closed, the water should not be completely drained off, otherwise the structure could be directly exposed to frost (the water acts as a temperature regulator). If there is no hydrostatic pressure from the water, the lift from the ground pushes against the structure of the pool and the lining. Since the lining is the most rigid part of the structure, it could crack, be damaged, lift or even detach. When a pool is closed, we recommend emptying the pipework, lowering the level of the water by 10/15 cm and protecting the pool with sheets of plastic on the surface of the water. Ice-breakers (polystyrene blocks, inner tubes, etc) may also be placed in the pool to offer further protection.



6. FINISHING THE INSIDE OF BATHS AND POOLS WITH ACRYLIC PAINT

MAPEI proposes a specific treatment cycle for those who prefer a coloured finish in a pool or bath containing water.

This cycle includes a layer on the bottom and side walls to even out the substrate, as described in section 4.2, and the creation of coving in the corners and around sharp edges.

Once the structure has been prepared as specified and the materials and products are fully cured, the bath or pool must be tested to make sure it is

WATERPROOFING BATHS AND SWIMMING POOLS

watertight. Once the bath or pool has been successfully tested, apply the finish as follows:

- Apply a coat of MAPECOAT I 600 W, two-component transparent primer in water dispersion diluted 1:1 with water;
- After 4-6 hours apply a waterproofing skim coat of TRIBLOCK FINISH, three-component thixotropic epoxy mortar for skimming damp substrates;
- Apply a second coat of MAPECOAT I 600 W diluted 1:1 with water 24 hours after applying TRIBLOCK FINISH;
- After 4-6 hours apply a first coat of ELASTOCOLOR WATERPROOF acrylic paint for permanent contact with water. This product is easy to clean and is resistant to all weather conditions, smog and direct sunlight;
- Apply a second coat of ELASTOCOLOR WATERPROOF the following day. A third coat will only be required (after a further 24 hours) if the colour chosen does not have good covering properties or if a thicker coat of finish is specified.

This system for coating internal surfaces, comprising the application of ELASTOCOLOR WATERPROOF paint after waterproofing the substrates with TRIBLOCK FINISH and MAPECOAT I 600 W, forms a compatible, elastic finish resistant to permanent contact with water.

ELASTOCOLOR WATERPROOF provides good resistance to the most commonly used chemical products for disinfecting water in swimming pools (chlorine and quaternary ammonium compounds). In certain cases, however, permanent contact with water may bleach the film of ELASTOCOLOR WATERPROOF. Therefore, if a medium or dark colour is used, annual maintenance must be scheduled to bring the finish back to its original colour. If special disinfectants are used in the water, preliminary tests must be carried out to verify the compatibility of ELASTOCOLOR WATERPROOF.

Since ELASTOCOLOR WATERPROOF is applied in thin coats (200-300 μm) and is not particularly resistant to high mechanical abrasion, if it is used in baths or swimming pools it could be rubbed off by equipment normally used to clean the surface (robots, brushing systems, etc.).



Fig. 6.1 - A swimming pool painted with ELASTOCOLOR WATERPROOF



Fig. 6.2 - Applying ELASTOCOLOR WATERPROOF with a roller

After completing the application cycle, wait at least 20 days before filling the bath or pool in normal weather conditions.

ELASTOCOLOR WATERPROOF is available in 6 standard colours, although other colours may be created according to individual samples using the ColorMap® automatic colouring system.

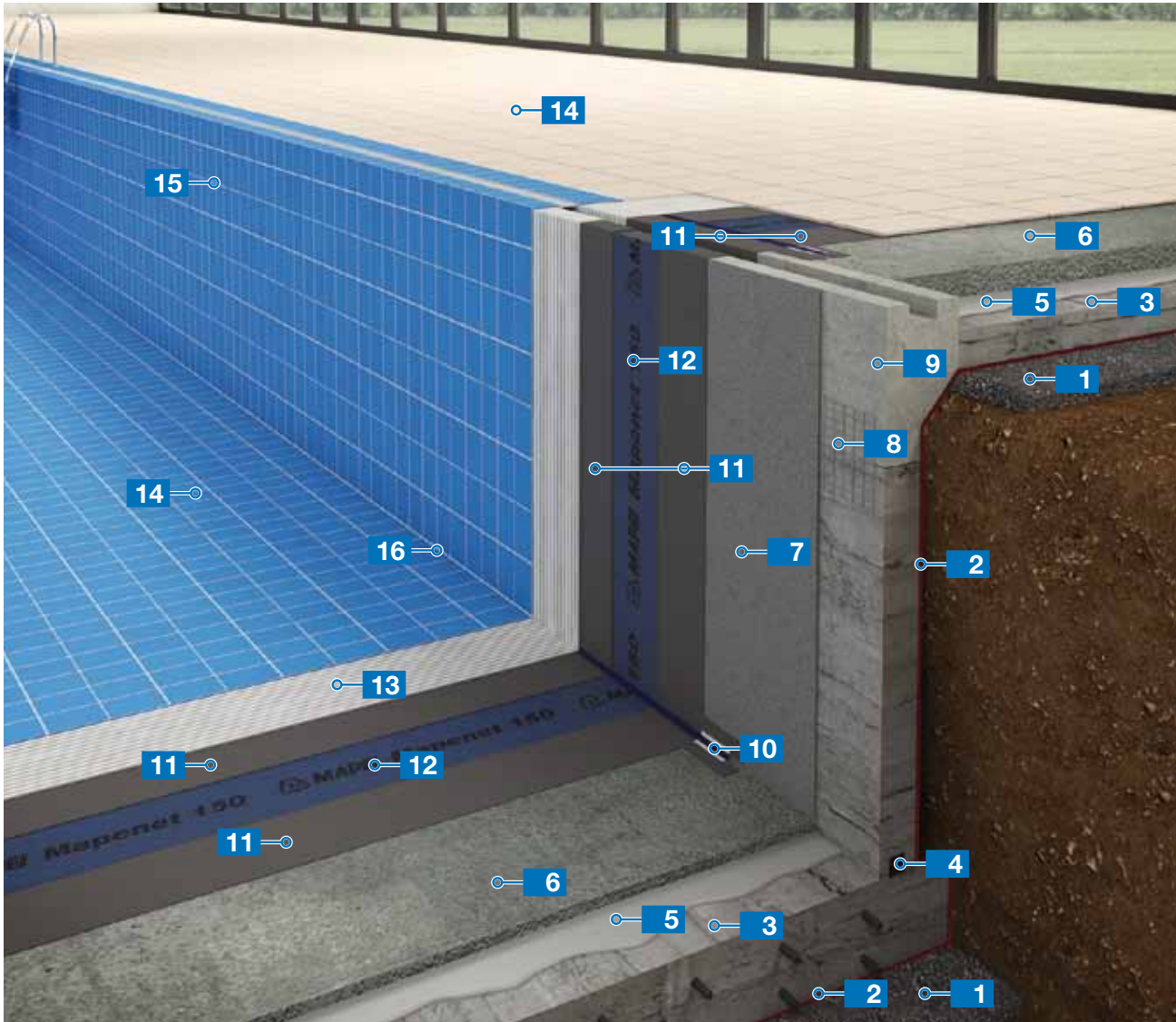

System for waterproofing and installing ceramic in new swimming pools

- | | | |
|--|--|---|
| <p>1 Regulating layer of concrete</p> <p>2 Waterproofing for the external part of the structure with Mapeproof sheets under the foundation bed and Mapelastic Foundation two-component elastic cementitious mortar on the walls after applying a coat of Primer 3296</p> <p>3 Reinforced concrete structure</p> <p>4 Idrostop B25 hydro-expanding bentonite joint</p> <p>5 Planicrete-based bonding slurry</p> <p>6 Screed Topcem Pronto</p> | <p>7 Cementitious render Nivoplan + Planicrete</p> <p>8 Metallic mesh to hold the render</p> <p>9 Precast overflow channel</p> <p>10 Rubber-backed tape Mapeband</p> <p>11 Waterproofing product (2 coats) Mapelastic</p> <p>12 Glass fibre mesh Mapenet 150</p> <p>13 Adhesive Keraflex Maxi S1</p> | <p>14 Ceramic tiles</p> <p>15 Grout Ultracolor Plus</p> <p>16 Sealant Mapesil AC</p> |
|--|--|---|

WATERPROOFING BATHS AND SWIMMING POOLS



**SA AQUATIC & LEISURE &
GP PLUS HEALTH CENTRE -
ADELAIDE**

Waterproofed with MAPELASTIC
SMART, MAPETEX SEL and
MAPEBAND



**TOCCACIELO HOTEL
AND TOURISM CENTRE -
NOVA SIRI MARINA**

Waterproofed with MAPELASTIC,
MAPENET 150 and MAPEBAND



**VILLA EOLO - FORTE
DEI MARMÌ**

Waterproofed with MAPELASTIC,
MAPENET 150 and MAPEBAND



**PUBLIC SPORTS COMPLEX
AND SWIMMING POOL -
MASSA**

Waterproofed with MAPELASTIC
FOUNDATION and MAPEBAND

WATERPROOFING BATHS AND SWIMMING POOLS



AQUAPARK - HRADEC

Waterproofed with MAPELASTIC,
MAPENET 150 and MAPEBAND



LA NOSTRA FAMIGLIA SWIMMING POOL - SAN VITO AL TAGLIAMENTO

Waterproofed with MAPELASTIC,
MAPENET 150 and MAPEBAND

Technical Manual

WATERPROOFING BATHS AND SWIMMING POOLS

C.P. MK 837830 - (GB) 5/14

HEADQUARTERS

MAPEI Spa

Via Cafiero, 22 - 20158 Milan (Italy)

Tel. +39-02-37673.1

Fax +39-02-37673.214

Internet: www.mapei.com

E-mail: mapei@mapei.it