

zoneTM 
architectural products

tepromark[®] 

architectural wall protection

corner guards | crash & handrails | wall sheet



We've got you covered

From concept to closeout, Tepromark focuses on the needs of healthcare, hospitality and educational interior wall surfaces. Our experienced team is ready with the information, tools and products necessary to find the best solution for your facility.

The Tepromark brand has global recognition in the manufacture and supply of commercial wall protection and associated products.

Tepromark more than meets the industry-specific needs of today. From updated profiles and a fresh colour palette, to simplifying specification and installation, Tepromark offers the product and experienced service that inherently has you covered.

ZONE supply and distribute the Tepromark brand of wall protection in New Zealand and have over 10 years experience of successful supply and installation project history. Zone stock a range of bumper profiles, and flat wall protection sheet in a range of popular colours, which is distributed from our Auckland warehouse.

Our team offer a specification service and can arrange installation across the country. If we don't have the colour you want in stock, we can source that for you. Zone can assist with custom colour matching.

Call us to discuss your requirements.

tepromark[®] 
architectural wall protection

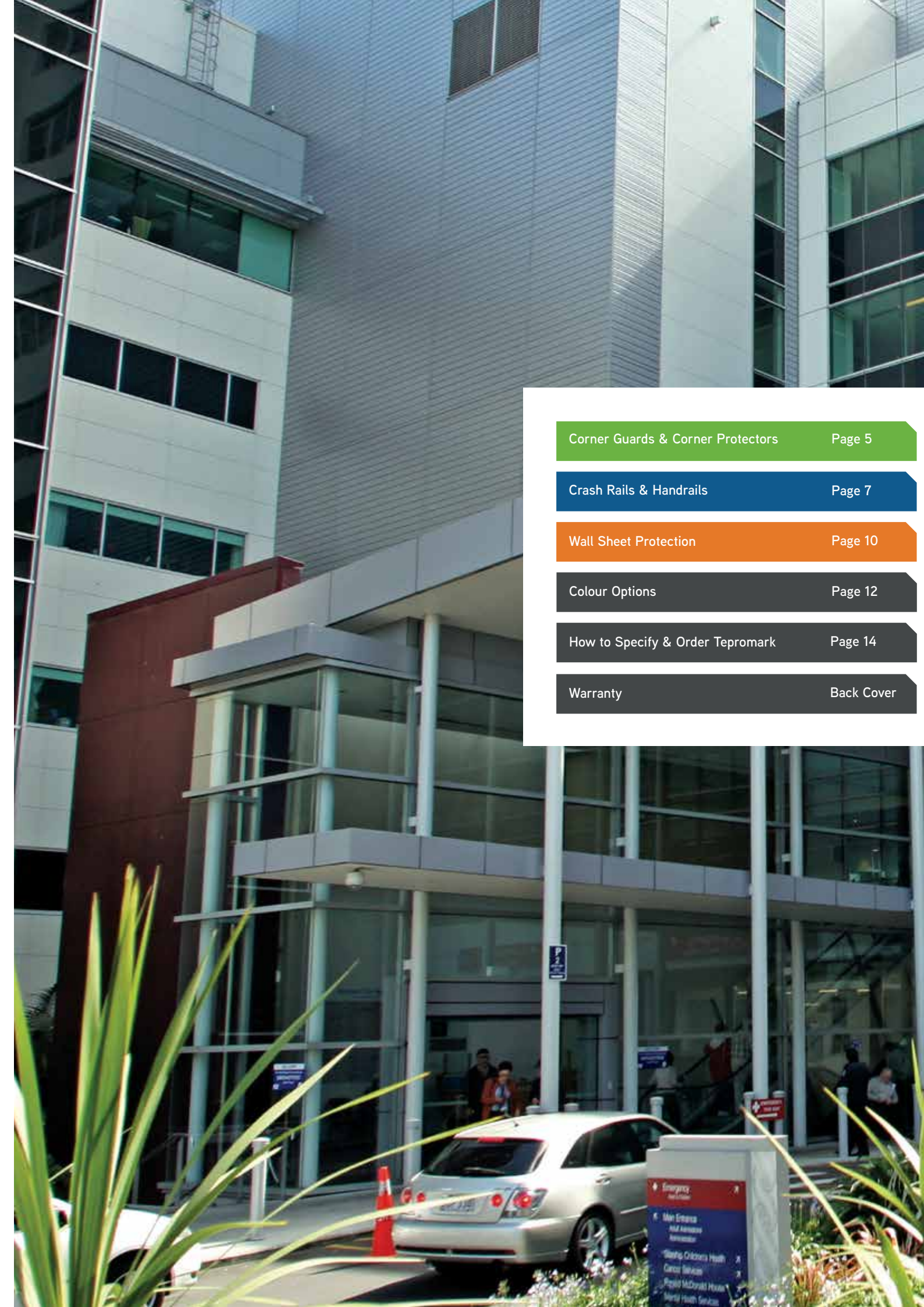

Corner Guards & Corner Protectors

Page 5

Crash Rails & Handrails

Page 7

Wall Sheet Protection

Page 10

Colour Options

Page 12

How to Specify & Order Tepromark

Page 14

Warranty

Back Cover

Emergency
A&E
Main Entrance
Stanley Children's Health
Cancer Services
Royal McDonald House
Nurse Health Services

Corner Guards & Corner Protectors

Premium high impact protection for exposed, vulnerable corners.
Available in stainless steel and rigid high impact plastic.

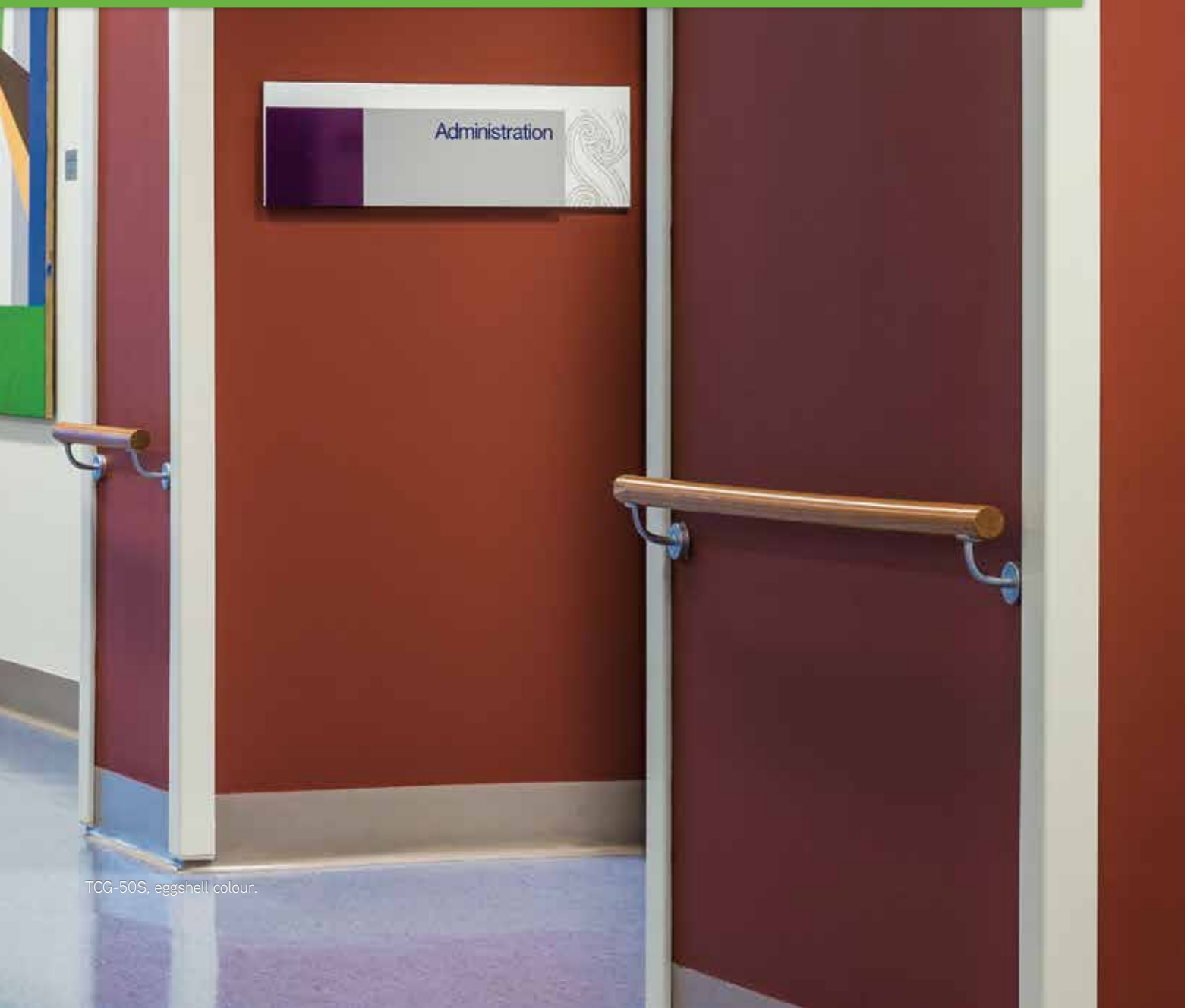

TCG-50S, eggshell colour.

High Impact Surface Mounted Corner Guards

Full length Aluminium retainer, snap on high impact plastic cover, and matching caps

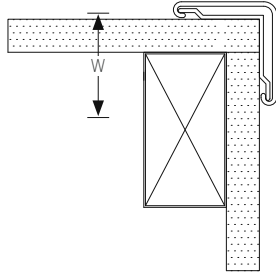

TCG-50 / TCG-75

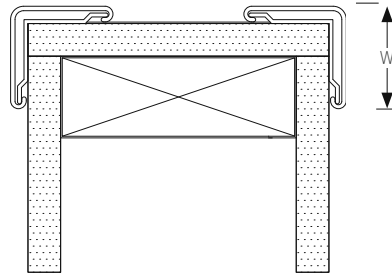

TCG-50EW

Standard Kits

Standard 2400mm kits have 2 end caps. Custom kit lengths are available, subject to a cut fee.

Code	(W) Wings	Corners	Description	Stock NZ	Colour	Length
TCG-50	50 mm	90°			020, 033	2400 mm
TCG-75	75 mm	90°	-		020, 033	2400 mm
TCG-75135	75 mm	135°	-	MTO	020, 033	2400 mm

Parts List

Code	(W) Wings	Corners	Description	Stock NZ	Colour	Length
TCG-50-2400	50 mm	90°	aluminium retainer	✓	NA	2400 mm
TCG-50-XXX-2400	50 mm	90°	vinyl snap on cover	✓	020, 033	2400 mm
TCG-50-XXX-EC	50 mm	90°	end cap	✓	020, 033	NA
TCG-75-2400	75 mm	90°	aluminium retainer	✓	NA	2400 mm
TCG-75-XXX-2400	75 mm	90°	vinyl snap on cover	✓	020, 033	2400 mm
TCG-75-XXX-EC	75 mm	90°	end cap	✓	020, 033	NA
TCG-75135-2400	75 mm	135°	aluminium retainer	✓	020, 033	2400 mm
TCG-75-XXX-2400	75 mm	135°	vinyl snap on cover	✓	020, 033	2400 mm
TCG-75-XXX-EC	75 mm	135°	end cap	✓	020, 033	NA

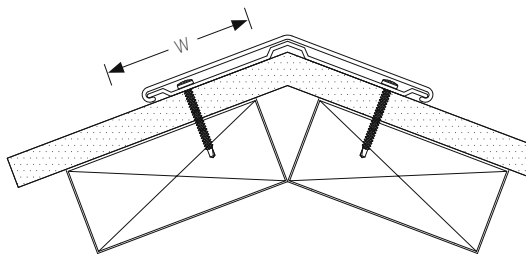

TCG-75135

S See page 12 for colour options

Stainless Steel Corner Protectors (Custom Length)

Stainless steel corner guards provide optimal strength corner protection and give a room a highly professional appearance. Well-suited to modern décor and industrial design, metal corner guard is the finest choice for high-impact environments.

Code	(W) Wings	Corners	Material	Stock NZ*	Length
TCP-38SS304	38 mm	90°	Type 304 Stainless Steel	MTO	1200mm
TCP-50SS304	50 mm	90°	Type 304 Stainless Steel	MTO	1200mm
TCP-64SS304	64 mm	90°	Type 304 Stainless Steel	MTO	1200mm
TCP-75SS304	75 mm	90°	Type 304 Stainless Steel	MTO	1200mm

*MTO 1-2 week delivery times

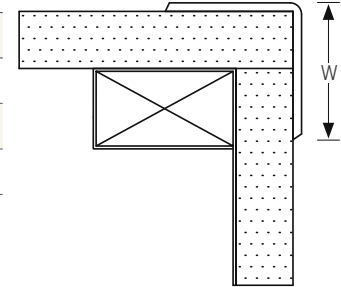

High Impact Corner Protectors

Self adhesive rigid plastic, double sided

Code	(W) Wings	Corners	Stock NZ	Colour*	Length
TCP-19V	19 mm	90°		033	2400 mm
TCP-29V	29 mm	90°		033	2400 mm
TCP-38V	38 mm	90°		020, 033	2400 mm
TCP-50V	50 mm	90°		033	2400 mm
TCP-64V	64 mm	90°		033	2400 mm
TCP-75V	75 mm	90°		033	2400 mm
TCP-64V135	64 mm	135°		033	2400 mm

* All corner protectors are available in clear polycarbonate by indent for use over painted surfaces.

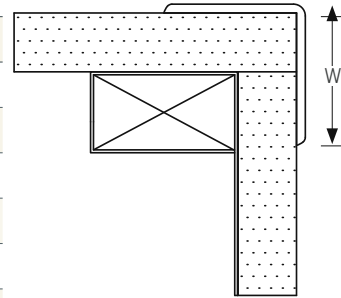

Paintable High Impact Corner Protectors

Paintable Corner Protectors offer the perfect customisation solution to match painted interiors and create a cohesive look. The paintable corner protector has an orange peel texture designed specifically for the optimal paint adhesion, while also providing first-rate protection for wall corners.

Code	(W) Wings	Corners	Stock NZ*	Colour	Length
TCP-19P	19 mm	90°	indent	white	2400 mm
TCP-29P	29 mm	90°	indent	white	2400 mm

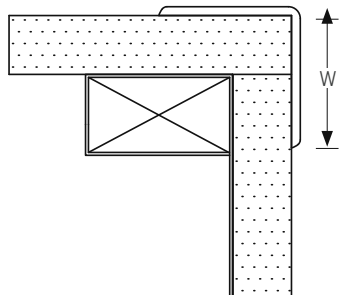

S See page 12 for colour options

Ordering & support: 0800 508 800 / info@zone.net.nz / www.zone.net.nz

Crash Rails, Handrails, Bed Bumpers

Our high impact crash rails provide superior protection from damage and wear caused by moving objects such as wheeling beds and trolleys. The textured cover snaps on an aluminium retainer which absorbs the impact through its excellent tensile strength and yield. The covers are hard-wearing, scratch resistant and can be cut to length as required.

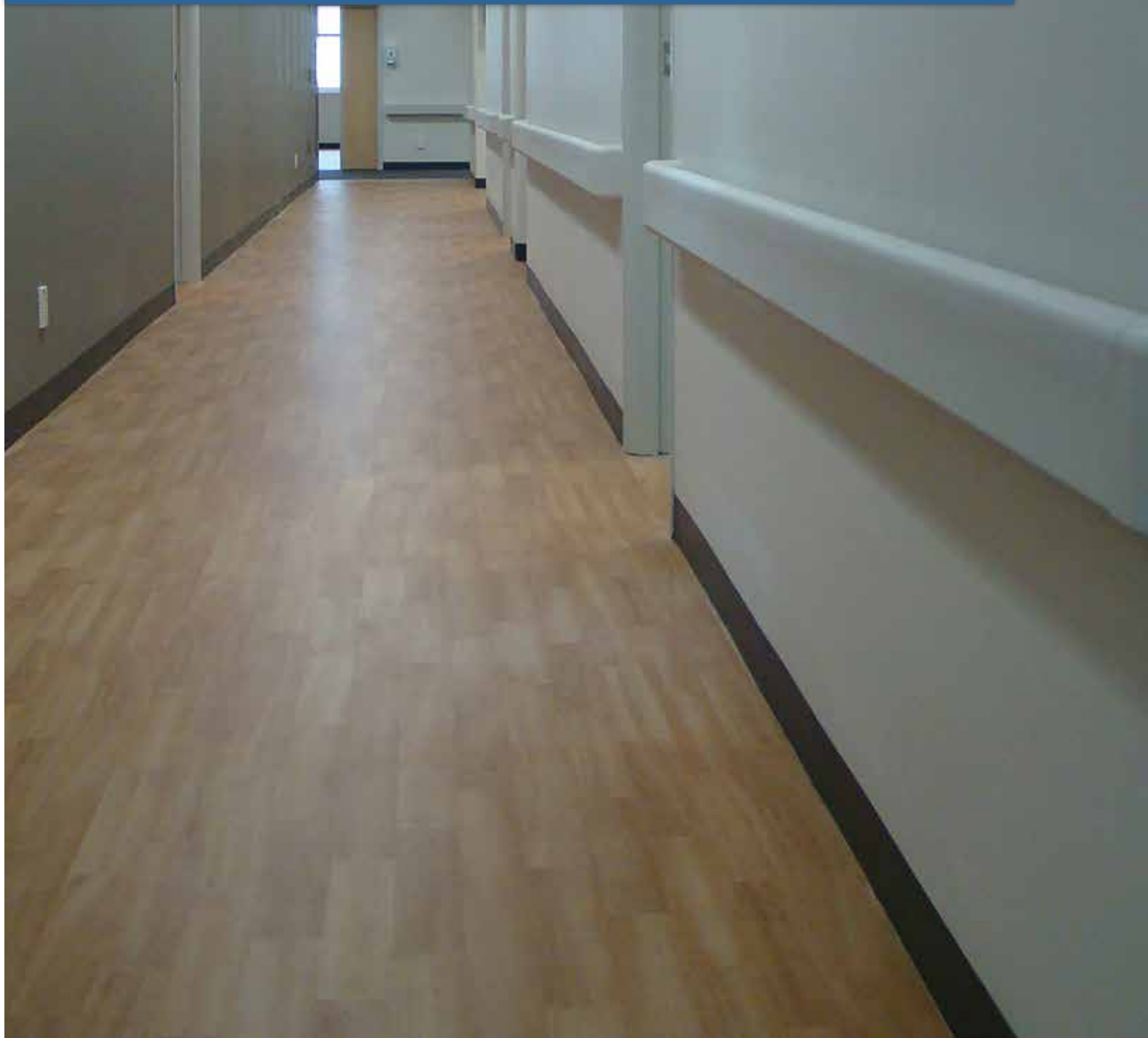

Crash Rails / Bed Bumpers

Kit includes; continuous aluminium retainer, high impact corners, impact absorbers

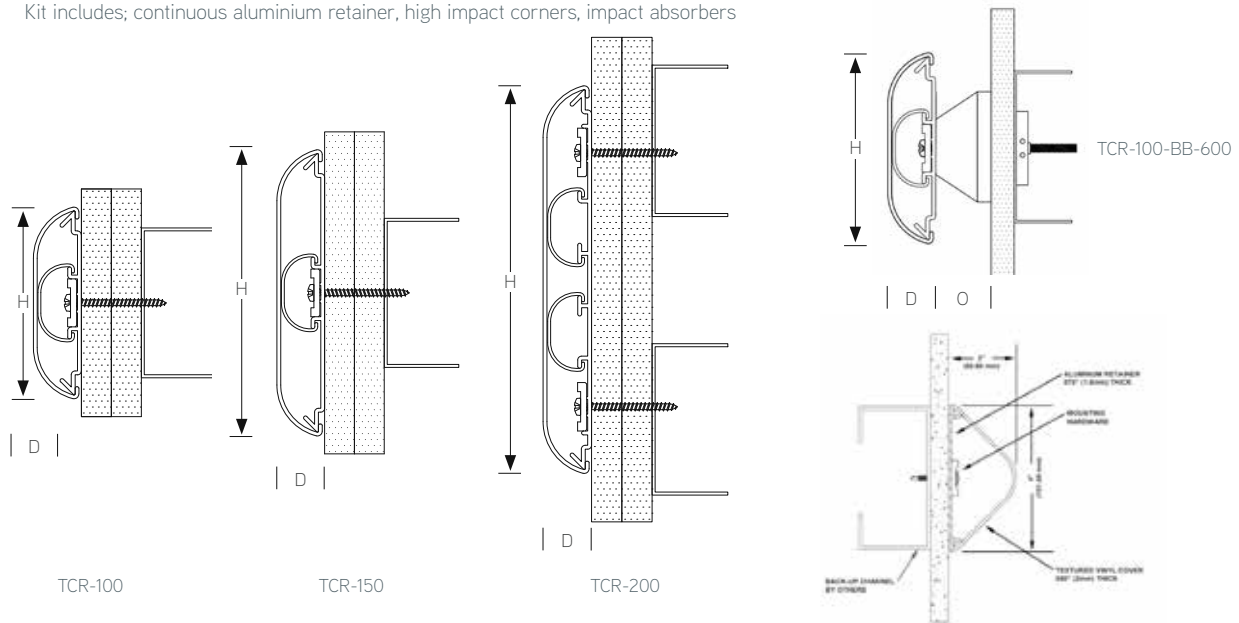

Code	(H) Height	D (Depth)	Description	Length	Stock NZ	Colour	O (Offset)
TCR-100	100 mm	25 mm	High Impact Crash Rail, Continuous Aluminium Retainer	3600 mm	✓	033	-
TCR-150	150 mm	25 mm	High Impact Crash Rail, Continuous Aluminium Retainer	3600 mm	✓	020, 033	-
TCR-200	200 mm	25 mm	High Impact Crash Rail, Continuous Aluminium Retainer	3600 mm		020, 033	-
TCR-100-BB-600	102 mm	25 mm	High Impact Bed Bumper with one space	544, 3600 mm	✓	020, 033	38 mm
TCR-100-BB2-600	102 mm	25 mm	High Impact Bed Bumper with two spacers	600 mm	✓	033	76 mm

Parts List

Code	Inc in Kit	Description	Length	Stock NZ	Colour
TCR-XXX-XXX-3600		snap on vinyl cover	3600 mm		020, 033
TCR-XXX-3600		aluminium retainer	3600 mm		NA
TCR-AB-3600		impact absorber	3600 mm		NA
TCR-XXX-XXX-EC		end cap	NA		020, 033
TCR-XXX-XXX-CA		corner adapter	NA		020, 033
THRL-140-XXX-CS		conical spacer (for bed bumper)	NA		020, 033

TCR-XXX-XXX-EC

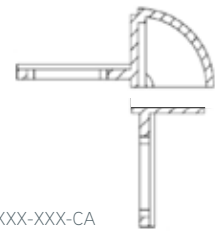

TCR-XXX-XXX-CA

Triangular Bumper Guards

The Triangular Wall Guard has a gently triangular profile to protect walls in high traffic areas with protruding objects like gurneys and wheelchairs. Cut fee will apply for specific lengths.

Code	(H) Height	D (Depth)	Description	Length	Stock NZ	Colour*
TBG-100	100 mm	25 mm	High Impact Crash Rail, Continuous Aluminium Retainer	3600 mm	indent	All

* Custom colours available with a min order quantity applicable.

Continuous aluminium retainer, high impact corners, impact absorbers

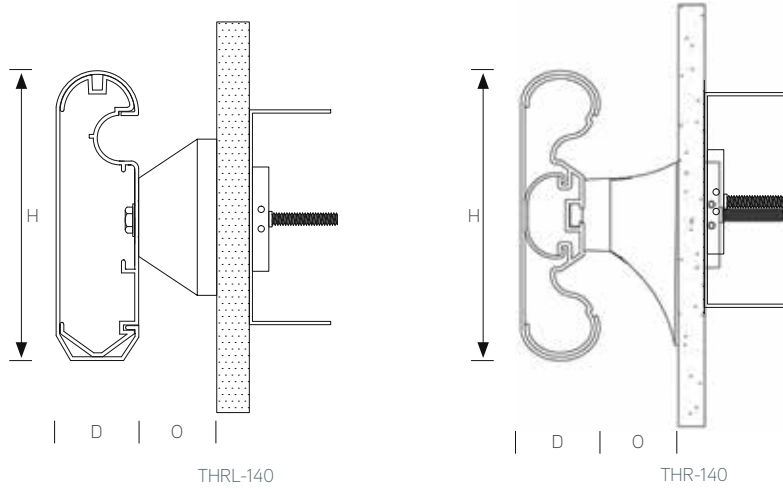

Code	(H) Height	D (Depth)	Description	Length	Stock NZ	Colour	O (Offset)
THRL-140-BB-600MM			THRL-140 bed bumper kit	600 mm	033		38mm
THR-140	140 mm	38 mm	Snap Lock Handrail / Crashrail, Extended mount	3600 mm	020, 033		40 mm
THR-140-BB-XXX			THR-140 bed bumper kit	600 mm	020, 033		40 mm

Parts List

Code	Description	Length	Stock NZ	Colour
THR-140-XXX-3600	snap on vinyl cover	3600 mm		020, 033
THR-140-3600	aluminium retainer	3600 mm		NA
TCR-AB-3600	impact absorber	3600 mm		NA
THR-140-XXX-ENDRETURN	end return kit (contains corner housing & 1no corner adapter)	NA		020, 033
THR-140-XXX-CA	corner adapter	NA		020, 033
THR-140-XXX-STANDOFF	mounting bracket / stand-off kit (contains see below)	NA		020, 033
	THR-140-XXX-SO stand-off			
	THR-140-LT INSERT lock tight insert			
	THR-140-XXX-LT PIN lock tight pin			
THR-140-XXX-CH	corner housing	NA		020, 033
THR-140-CA	corner adapter	NA		NA
THR-140-SHIMKIT	0.6 mm, 1.0 mm, 1.5 mm & 2.0 mm shims for installation	NA		white
THRL-140-033-3600	snap on vinyl cover	3600 mm		033
THRL-140-3600	aluminium retainer	3600 mm		NA
THRL-140-033-LHR KIT	left hand return kit (contains corner housing & 1no corner adapter)	3600 mm		033
THRL-140-033-RHR KIT	right hand return kit (contains corner housing & 1no corner adapter)	3600 mm		033
THRL-140-033-OC KIT	outside corner kit (contains corner housing & 2no corner adapters)	3600 mm		033
THRL-140-033-CH	corner housing	NA		033
THRL-140-BLK-LH	left corner adapter	NA		black
THRL-140-BLK-RH	right corner adapter	NA		black
THRL-140-XXX-CS	conical spacer (for bed bumper)	NA		020, 033

Wall Sheet Protection

Offering excellent impact, stain, and chemical resistance.

- Tested to EN13501-2007, (B, s3, D0), achieves NZ Group 1 fire rating (1.5mm & 2mm)
- Outstanding impact resistance, rigidity and heat deflection temperature
- 1.0 (Group 2), 1.5mm & 2.0mm (Group 1) sheet thicknesses
- 1220 X 2440mm sheet size, custom cutting available
- Fine texture, co-extruded matt surface
- Non PNC, no VOC adhesive, thermoformable
- White & Eggshell ex NZ, other colours (including colour match), lead time applicable
- System accessories include low profile anodised aluminium jointers
- Fungal and bacterial resistant to ATSMG-21 and G-22



TWS-060 and THRL-140, eggshell colour

Wall Sheet Protection



Code	System Component	Gauge	Features	Fire Rating	Stock Colour *	Stock NZ	Size
TWS-040	Wall sheet	1.0 mm	Rigid Sheet, Light Texture	Fire-rated Group 2	020, 033		2440 X 1220 mm
TWS-060	Wall sheet	1.5 mm	Rigid Sheet, Light Texture	Fire-rated Group 1	020, 033		2440 X 1220 mm
TWS-080	Wall sheet	2.0 mm	Rigid Sheet, Light Texture	Fire-rated Group 1	-	Indent	2440 X 1220 mm

* For the range of standard colours, please refer to page 12 of the catalogue. All sheet thicknesses are available in a custom colours or colour match with a min. order quantity and lead time.

Wall Sheet Protection Accessories

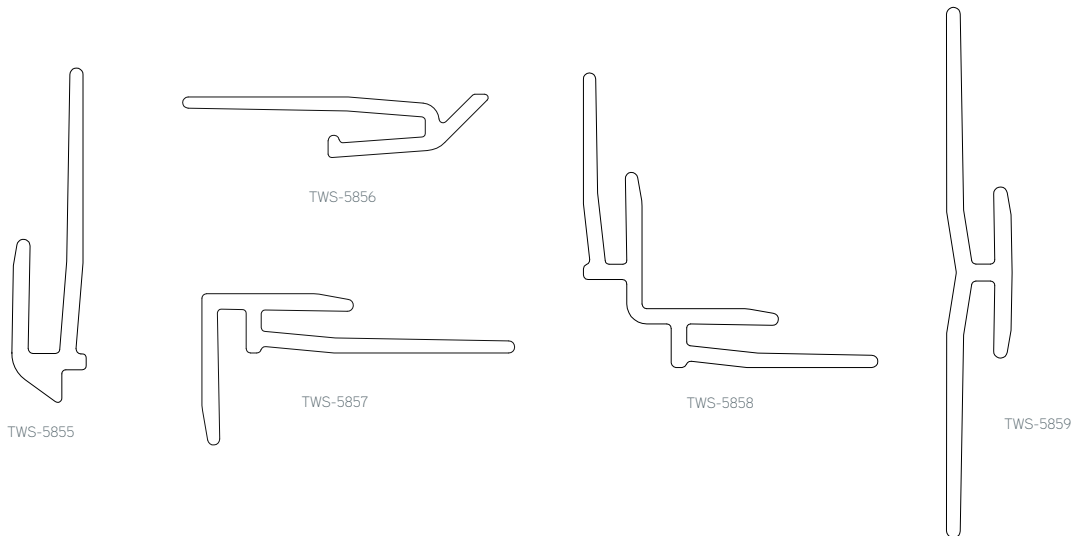

Code	System Component	Features	Lengths	Stock NZ
TWS-TA	Sheet Adhesive	-	-	
TWS-5856	Top edge Jointer	-	2400 mm	
TWS-5859	Sheet to sheet Jointer	-	2400 mm	
TWS-DFG	Door Jamb Protector 1mm	Rigid, Fire-rated Group 2	1200mm or 2400 mm	custom made
TWS-5855	Bottom edge Jointer	-	2400 mm	
TWS-5857	Outside corner Jointer	-	2400 mm	
TWS-5858	Inside corner Jointer	-	2400 mm	

Colour Options

Zone offers stocked colours of Tepromark in White and Eggshell. There is a wide range of standard colours and custom colours available with a minimum order quantity. Our standard palette has been carefully chosen to complement today's modern interiors.

This colour chart is for use as a general guide only. Due to printing limitations, the colours shown may not be representative of the actual product colours. Please contact us to discuss your requirements directly.

Stock NZ Colours

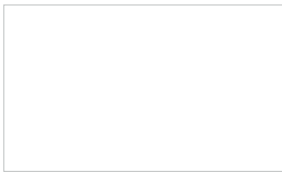

020 - White

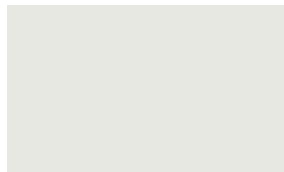

033 - Eggshell

STD - Standard Colours

Indent min quantity 50 sheets

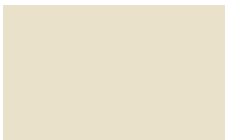

W415 - Ivory



W416 - Bisque



2728 - Pink Champagne



3485 - Sawdust



3482 - Desert Sand



G489 - Taupe



3483 - Sandstone



W414 - Mushroom



5781 - French Blue



4418 - Mint



4417 - Forest



5780 - Peaceful Blue



2729 - Pinot Noir



1384 - Brown

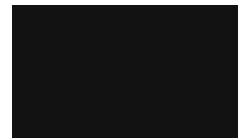

9072 - Black



5779 - Navy



3484 - Khaki



G490 - Concrete



D276 - Charcoal

Custom Colours

Tepromark offers a wide variety of alternative colours as well as the ability to match custom colours per request. Indent + min quantity 50 sheets. Please discuss your design and project needs with the Zone team.

tepromark® 

wall protection



How to Specify and Order Tepromark

Tepromark can be specified using our Masterspec work section 5152ZT. A link to this can also be found on our website www.zone.net.nz. The product codes have been written throughout the catalogue. Where XXX appears, this may be a colour requirement or length.

All colours have codes and names. Please refer to page 12 of the catalogue. These can also be found on our website.

Deciphering the Product Codes



Key:

- T = Tepromark
- WS = Wall Sheet
- CG = Corner Guard
- CP = Corner Protectors
- CR = Crash Rails
- BG = Bed Bumpers (Bumper Guards)
- HR = Hand Rails

It is easy to specify or order Tepromark as a KIT which comes with the necessary components for installation.

Not all components are KITS. We have detailed a list of spare parts which can be ordered separately.

Installation Service

Zone supplies or can arrange a supply and install service of Tepromark using our experienced installers. Please ask your Zone salesperson for further information.

tepromark® 

wall protection





Limited Warranty

ZONE will repair or replace Tepromark wall protection products that are defective in workmanship or material quality based on the schedule below. Liability under this warranty is limited to materials only, not including installation costs involved in the repair and/or replacement process. Zone Architectural Products waives responsibility for incidental or consequential damage of any nature. Any repair work or alteration of the product not done under supervision, or subject to the approval of Tepromark, shall void any liability under this limited warranty.

Vinyl Wall Protection Products	5 years
Stainless Steel Wall Protection Products	1 years

zone™ 
architectural products

Ordering & support
0800 508 800
info@zone.net.nz

Specification & technical data
www.zone.net.nz