

TPO to be laid with adhesive to substrate and parapet prior to installation of parapet cap.

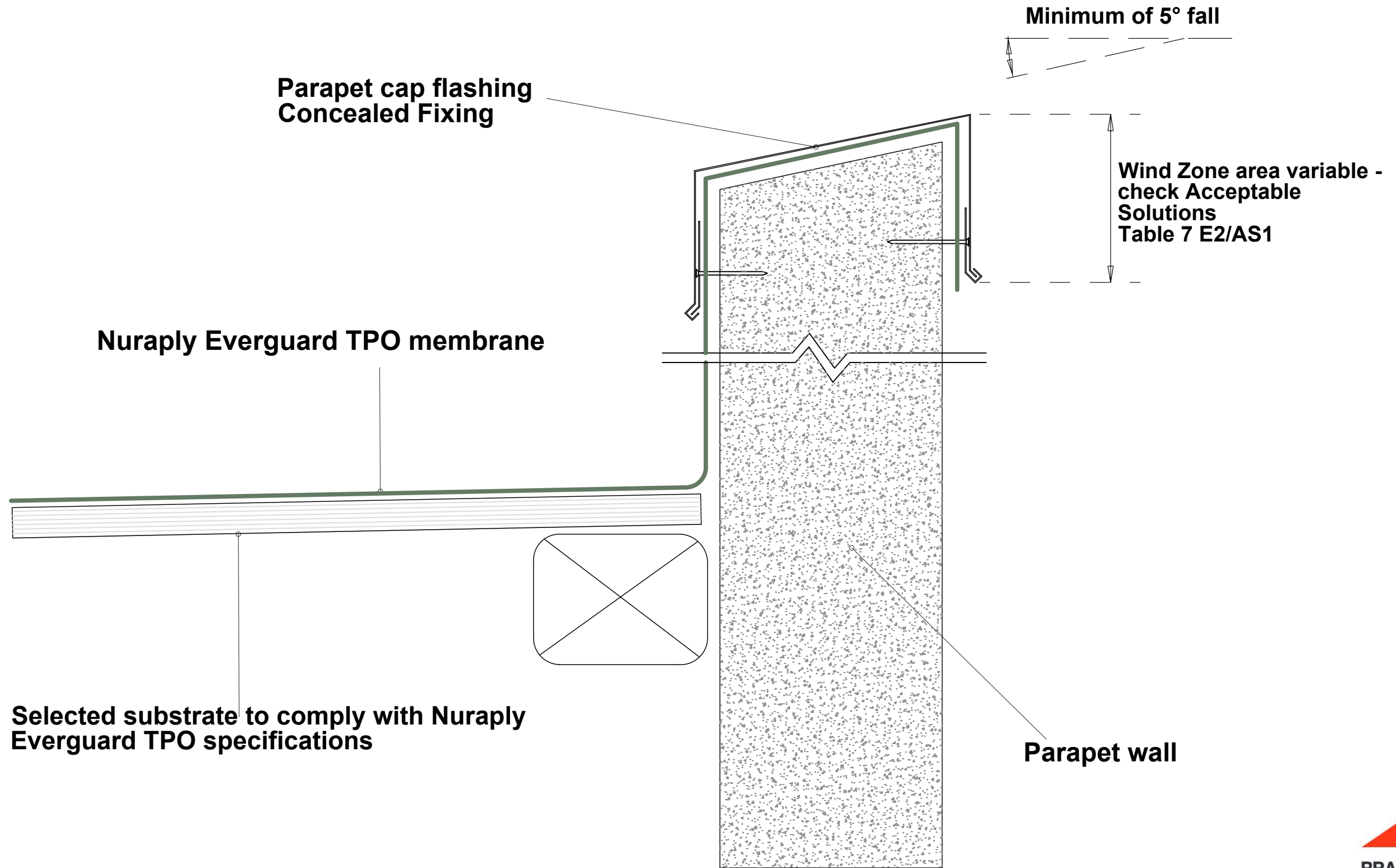

Selected substrate to comply with Nuraply Everguard TPO specifications



TPO to be laid with adhesive to substrate and parapet.

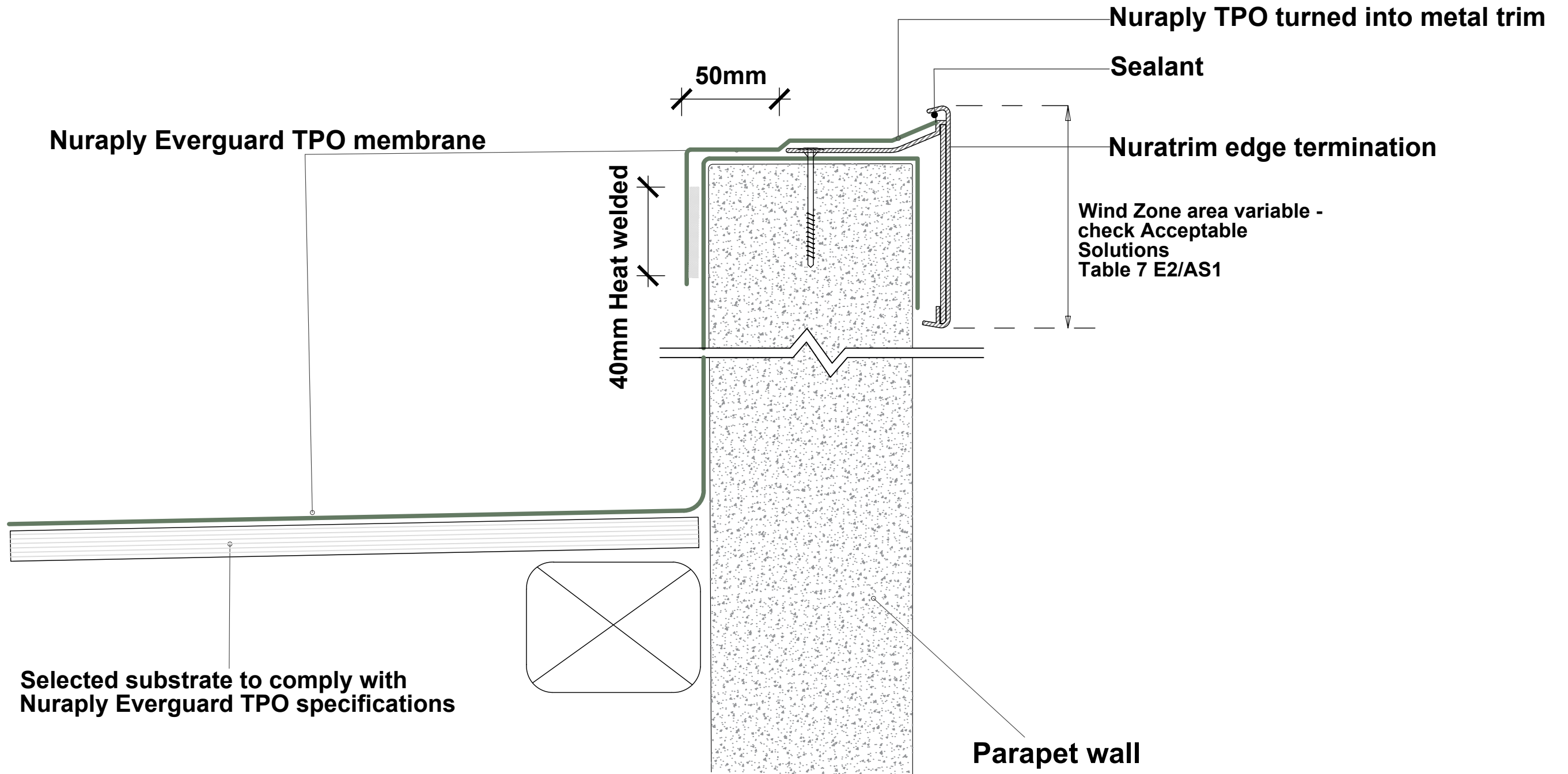

THIS DRAWING IS INDICATIVE ONLY AND NOT FOR CONSTRUCTION  
FOR A TECHNICAL REVIEW OF SPECIFICATIONS AND PLANS , LODGE DOCUMENTS AT [WWW.NURALITE.CO.NZ/TECHCHECK/](http://WWW.NURALITE.CO.NZ/TECHCHECK/)

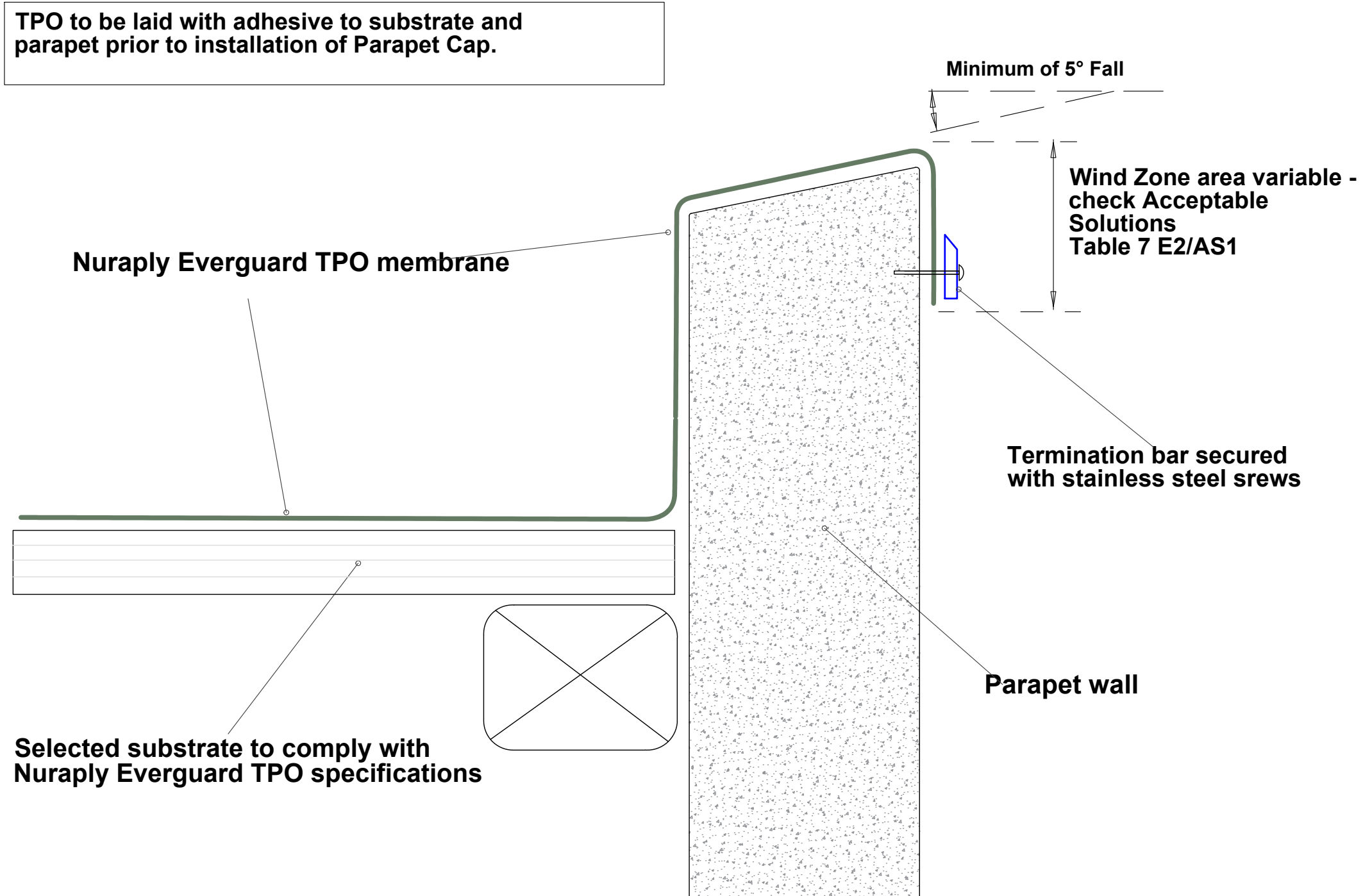

All Nuralite products/systems to be installed by an authorized Nuralite applicator and in accordance with Nuralite published instruction. Product data sheets should be consulted at all times. This drawing is a guide and is not for construction. This detail drawing is to be used only as part of the Nuralite specification package. All drawings are subject to copyright. Unauthorized use is prohibited. © Nuralite Waterproofing Ltd  
0800 - NURALITE (687254) [www.nuralite.co.nz](http://www.nuralite.co.nz)

PRODUCT/SYSTEM:	<b>NURAPLY EVERGUARD TPO</b>		
DETAIL:	PARAPET TERMINATION BAR		
SCALE: <b>NTS</b>	DATE: <b>JULY 2017</b>	PREVIOUS DWG no:	REVISION: -
			DWG no: <b>ETPO.A3</b>

**THIS DRAWING IS INDICATIVE ONLY AND NOT FOR CONSTRUCTION  
FOR A TECHNICAL REVIEW OF SPECIFICATIONS AND PLANS , LODGE DOCUMENTS AT [WWW.NURALITE.CO.NZ/TECHCHECK/](http://WWW.NURALITE.CO.NZ/TECHCHECK/)**

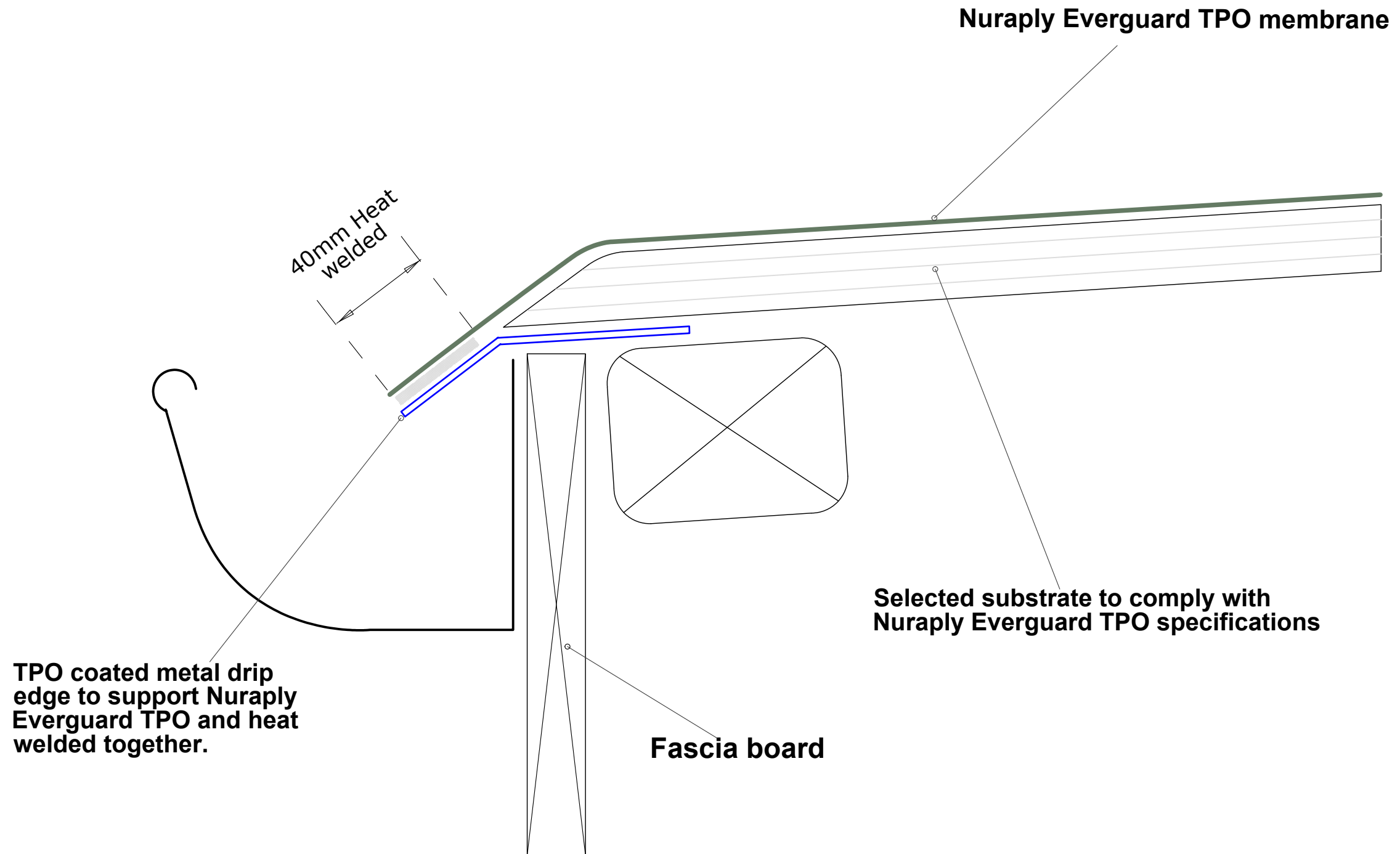



THIS DRAWING IS INDICATIVE ONLY AND NOT FOR CONSTRUCTION  
FOR A TECHNICAL REVIEW OF SPECIFICATIONS AND PLANS , LODGE DOCUMENTS AT [WWW.NURALITE.CO.NZ/TECHCHECK/](http://WWW.NURALITE.CO.NZ/TECHCHECK/)

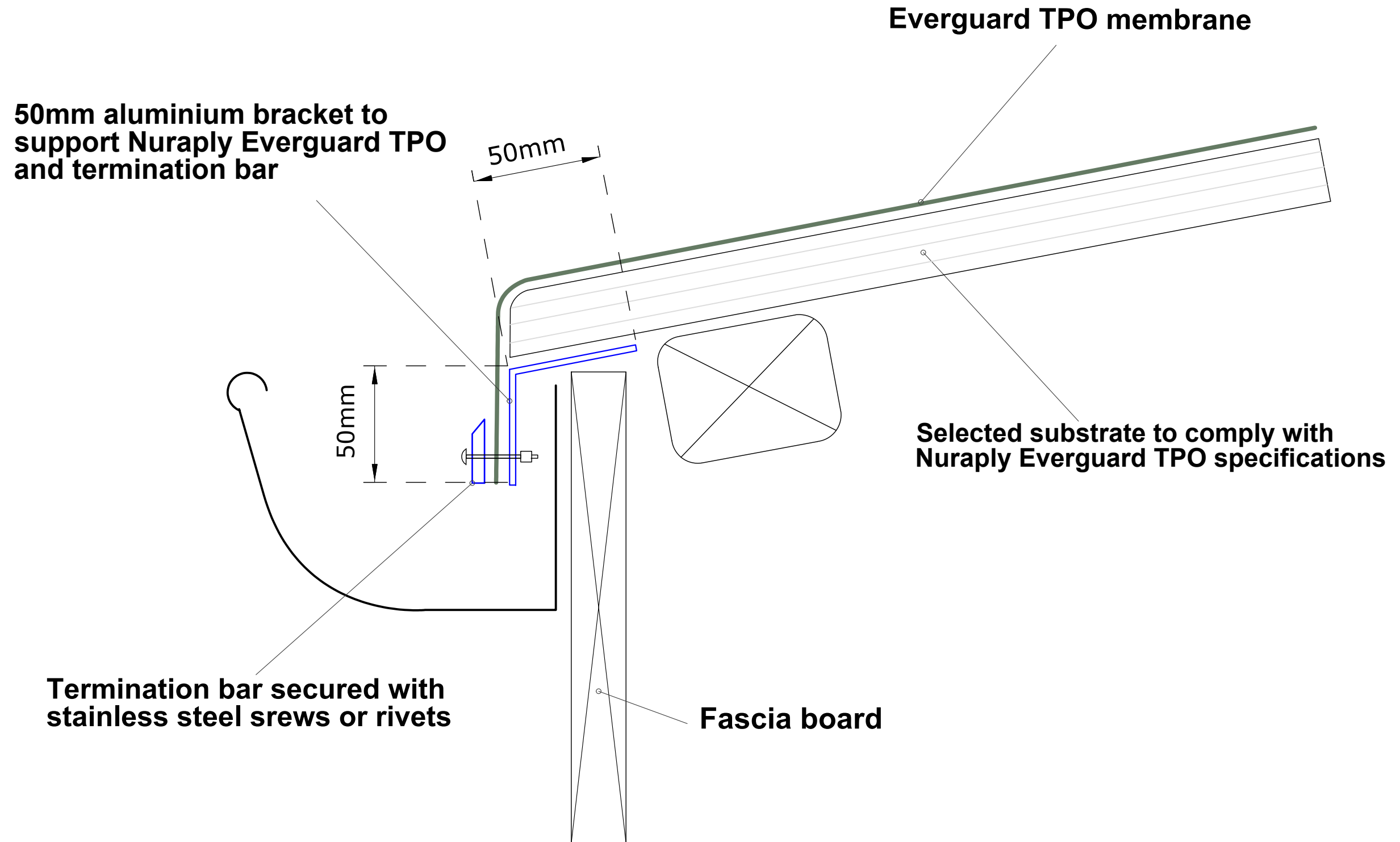

All Nuralite products/systems to be installed by an authorized Nuralite applicator and in accordance with Nuralite published instruction. Product data sheets should be consulted at all times. This drawing is a guide and is not for construction. This detail drawing is to be used only as part of the Nuralite specification package. All drawings are subject to copyright. Unauthorized use is prohibited. © Nuralite Waterproofing Ltd

0800 - NURALITE (687254) [www.nuralite.co.nz](http://www.nuralite.co.nz)

PRODUCT/SYSTEM:

**NURAPLY EVERGUARD TPO**

DETAIL:

**DRIP EDGE**

SCALE: **NTS**

DATE: **JULY 2017**

PREVIOUS DWG no:

REVISION: -

DWG no: **ETPO.A5**

THIS DRAWING IS INDICATIVE ONLY AND NOT FOR CONSTRUCTION  
 FOR A TECHNICAL REVIEW OF SPECIFICATIONS AND PLANS , LODGE DOCUMENTS AT [WWW.NURALITE.CO.NZ/TECHCHECK/](http://WWW.NURALITE.CO.NZ/TECHCHECK/)

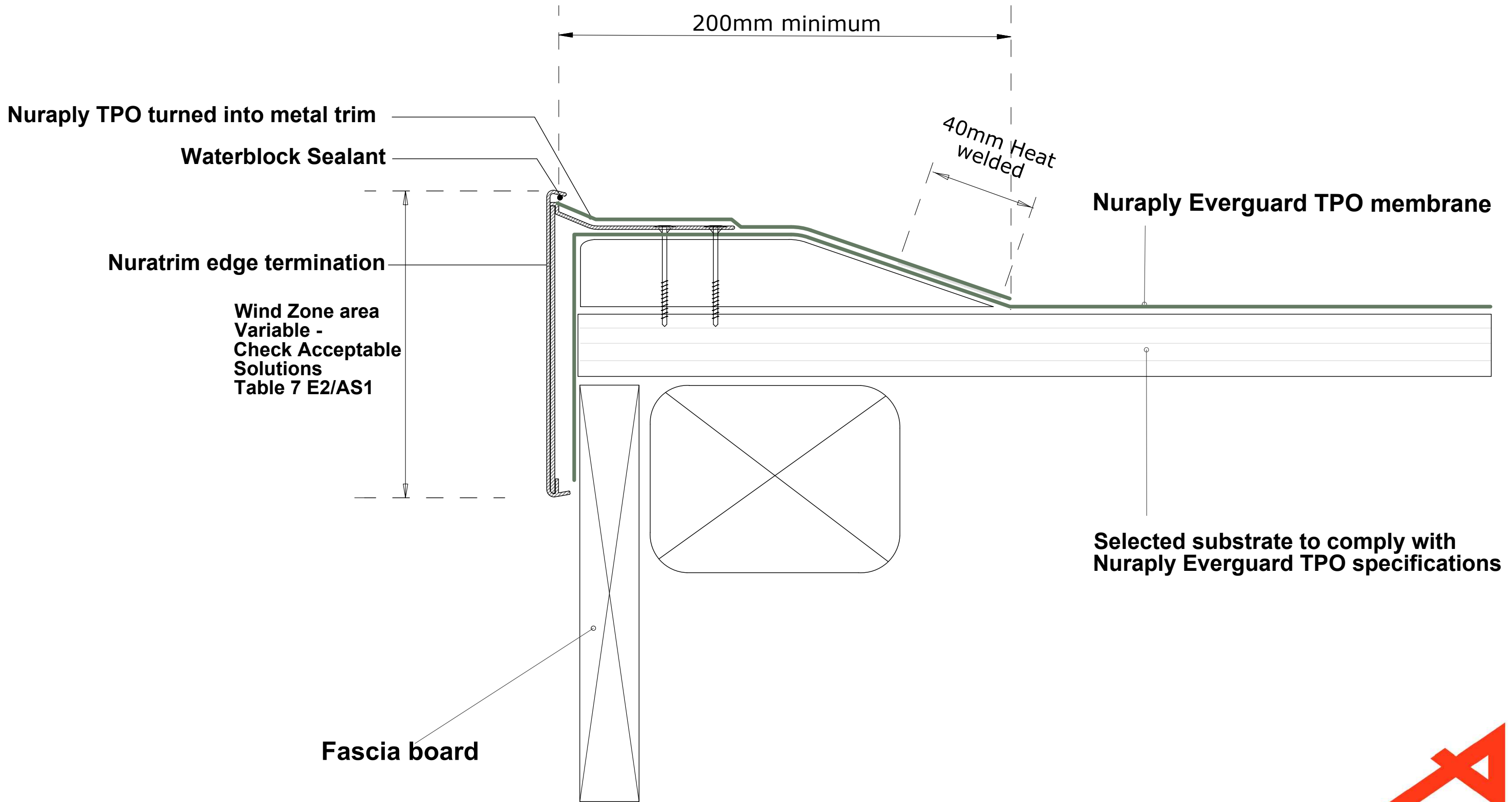

All Nuralite products/systems to be installed by an authorized Nuralite applicator and in accordance with Nuralite published instruction. Product data sheets should be consulted at all times. This drawing is a guide and is not for construction. This detail drawing is to be used only as part of the Nuralite specification package. All drawings are subject to copyright. Unauthorized use is prohibited. © Nuralite Waterproofing Ltd  
 0800 - NURALITE (687254) www.nuralite.co.nz

PRODUCT/SYSTEM:	<b>NURAPLY EVERGUARD TPO</b>		
DETAIL:	<b>NURATRIM BARGE FLASHING</b>		
SCALE: <b>NTS</b>	DATE: <b>JULY 2017</b>	PREVIOUS DWG no:	REVISION: -
			DWG no: <b>ETPO.A6</b>

**THIS DRAWING IS INDICATIVE ONLY AND NOT FOR CONSTRUCTION**  
**FOR A TECHNICAL REVIEW OF SPECIFICATIONS AND PLANS , LODGE DOCUMENTS AT [WWW.NURALITE.CO.NZ/TECHCHECK/](http://WWW.NURALITE.CO.NZ/TECHCHECK/)**

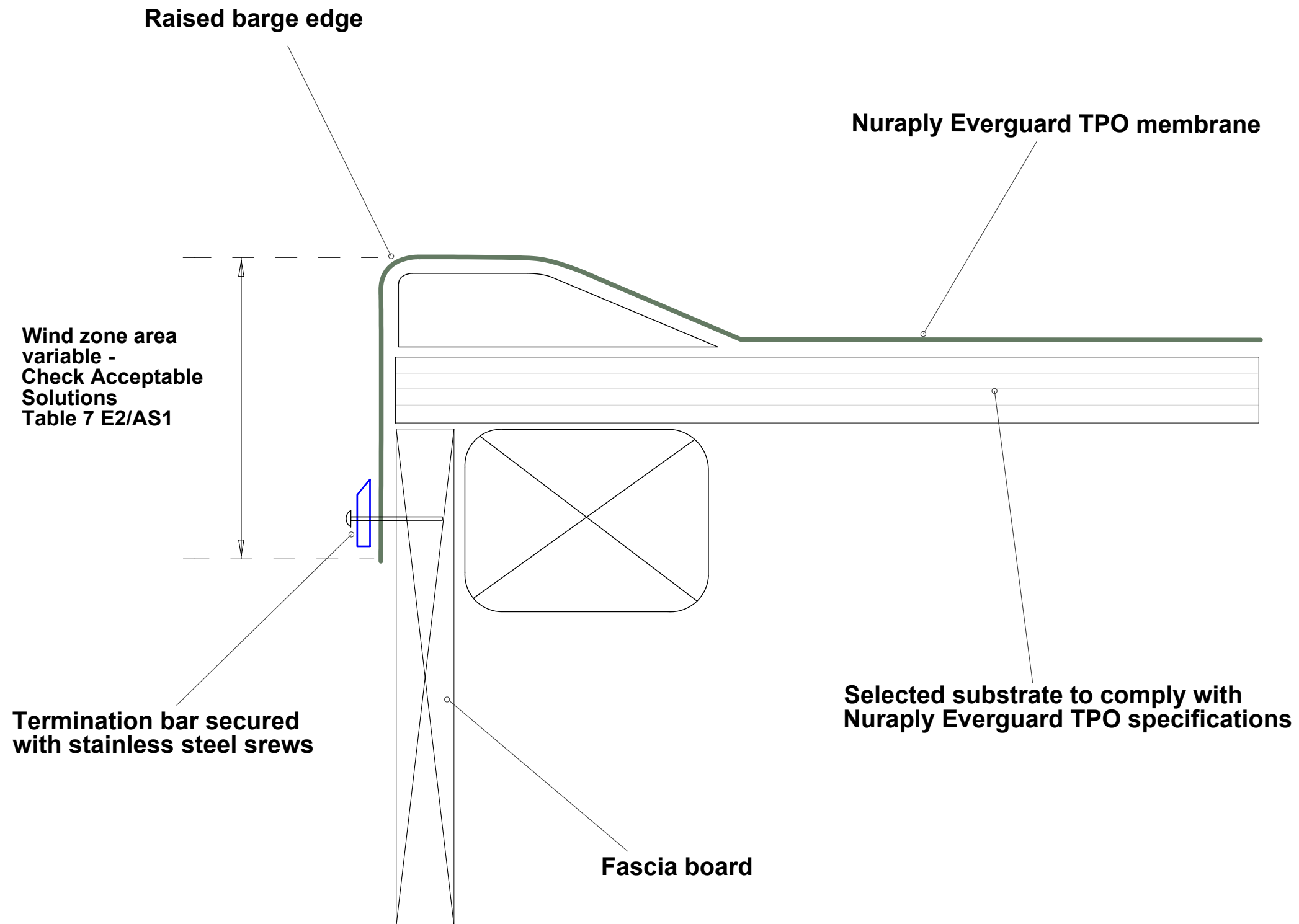

**THIS DRAWING IS INDICATIVE ONLY AND NOT FOR CONSTRUCTION  
FOR A TECHNICAL REVIEW OF SPECIFICATIONS AND PLANS , LODGE DOCUMENTS AT [WWW.NURALITE.CO.NZ/TECHCHECK/](http://WWW.NURALITE.CO.NZ/TECHCHECK/)**

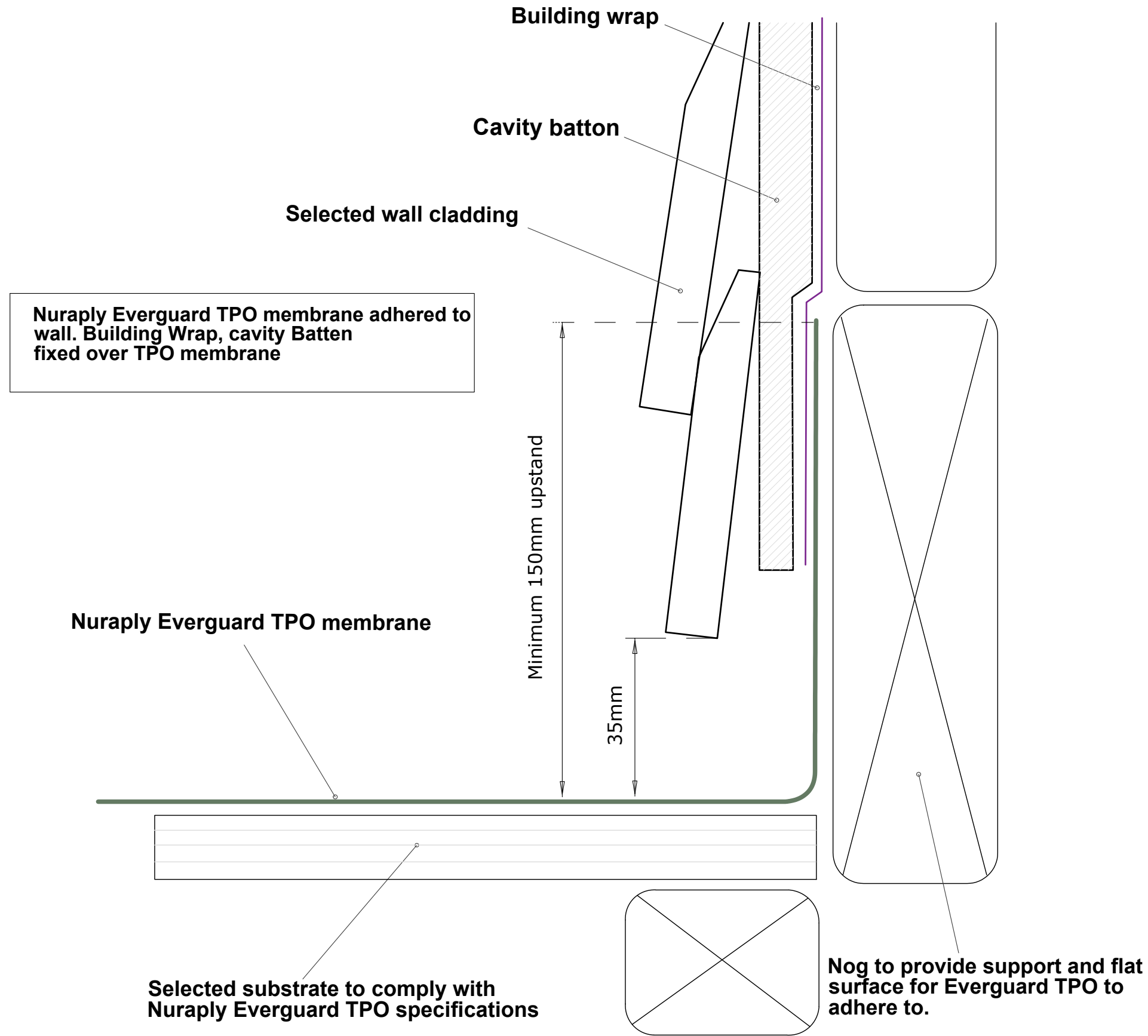

**THIS DRAWING IS INDICATIVE ONLY AND NOT FOR CONSTRUCTION  
FOR A TECHNICAL REVIEW OF SPECIFICATIONS AND PLANS , LODGE DOCUMENTS AT WWW.NURALITE.CO.NZ/TECHCHECK/**

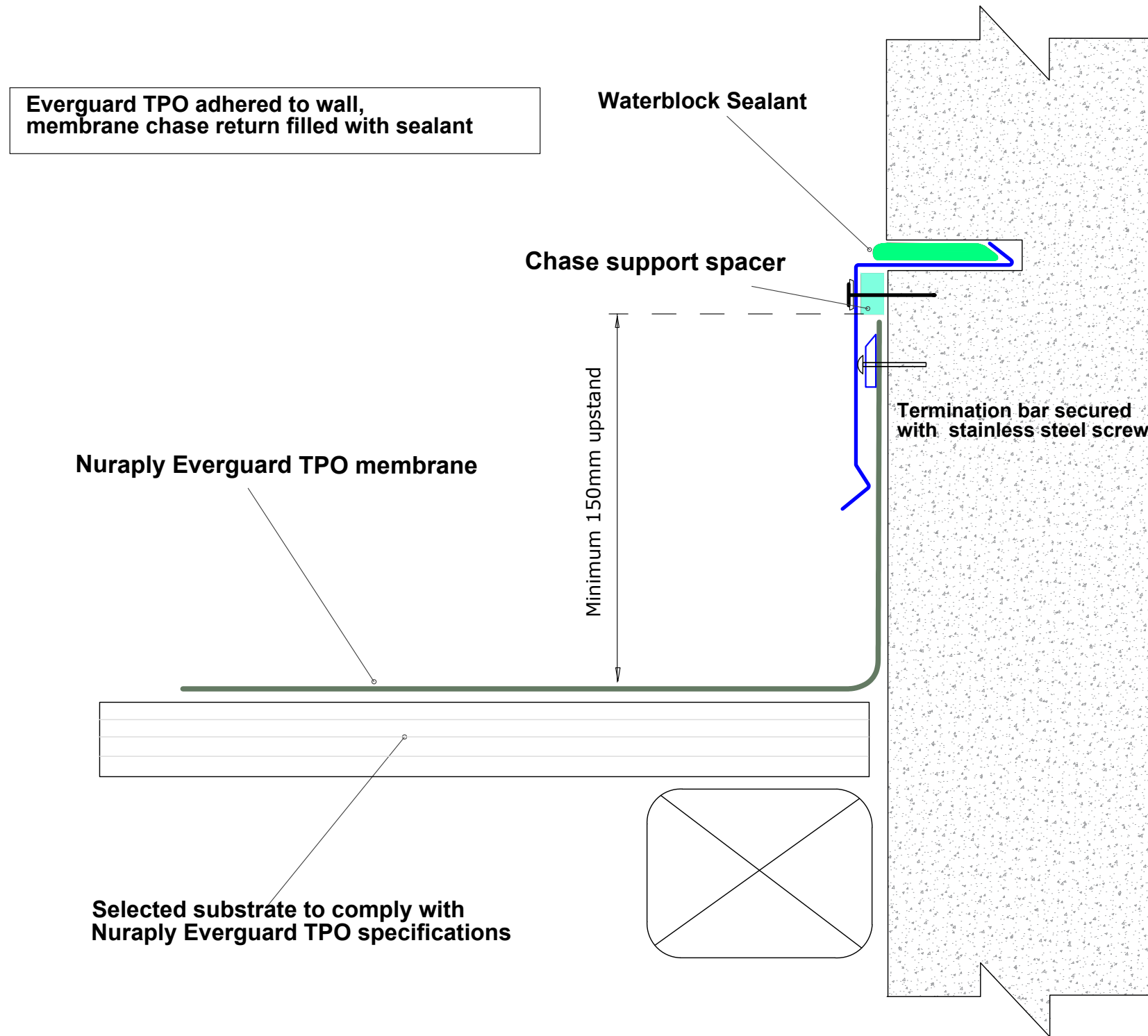



**THIS DRAWING IS INDICATIVE ONLY AND NOT FOR CONSTRUCTION**  
**FOR A TECHNICAL REVIEW OF SPECIFICATIONS AND PLANS , LODGE DOCUMENTS AT [WWW.NURALITE.CO.NZ/TECHCHECK/](http://WWW.NURALITE.CO.NZ/TECHCHECK/)**

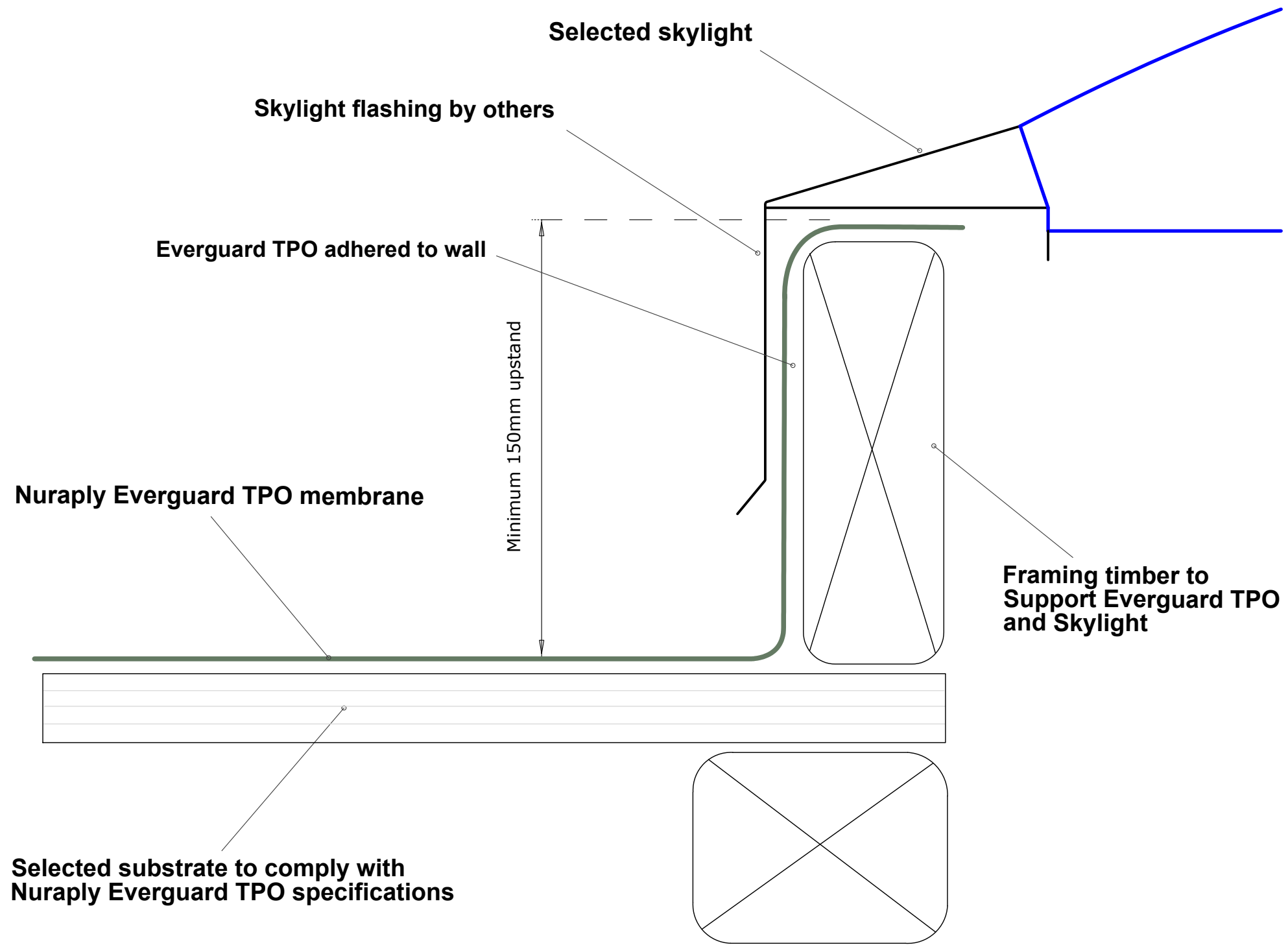

**THIS DRAWING IS INDICATIVE ONLY AND NOT FOR CONSTRUCTION  
FOR A TECHNICAL REVIEW OF SPECIFICATIONS AND PLANS , LODGE DOCUMENTS AT [WWW.NURALITE.CO.NZ/TECHCHECK/](http://WWW.NURALITE.CO.NZ/TECHCHECK/)**

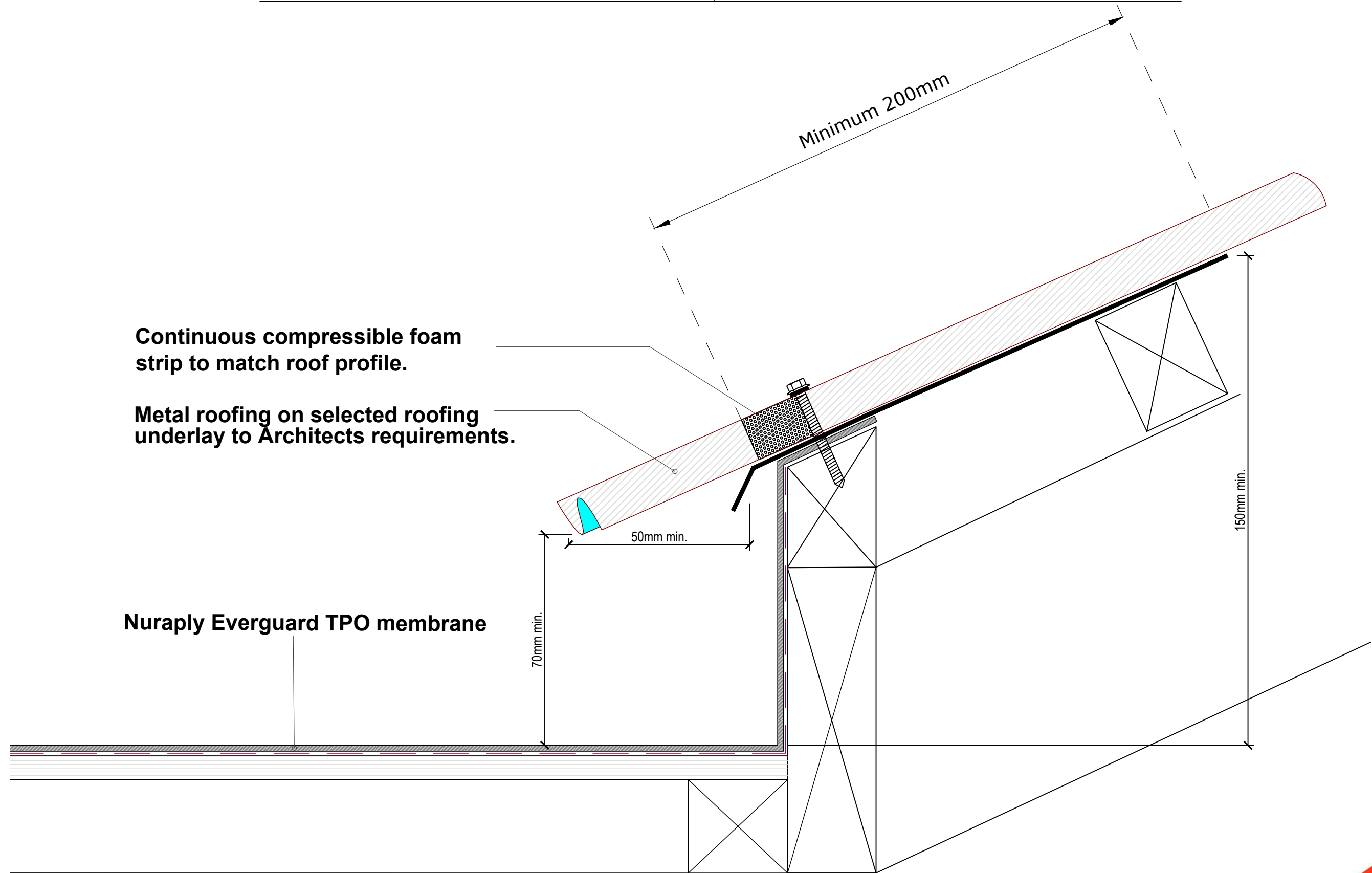

THIS DRAWING IS INDICATIVE ONLY AND NOT FOR CONSTRUCTION  
FOR A TECHNICAL REVIEW OF SPECIFICATIONS AND PLANS , LODGE DOCUMENTS AT [WWW.NURALITE.CO.NZ/TECHCHECK/](http://WWW.NURALITE.CO.NZ/TECHCHECK/)

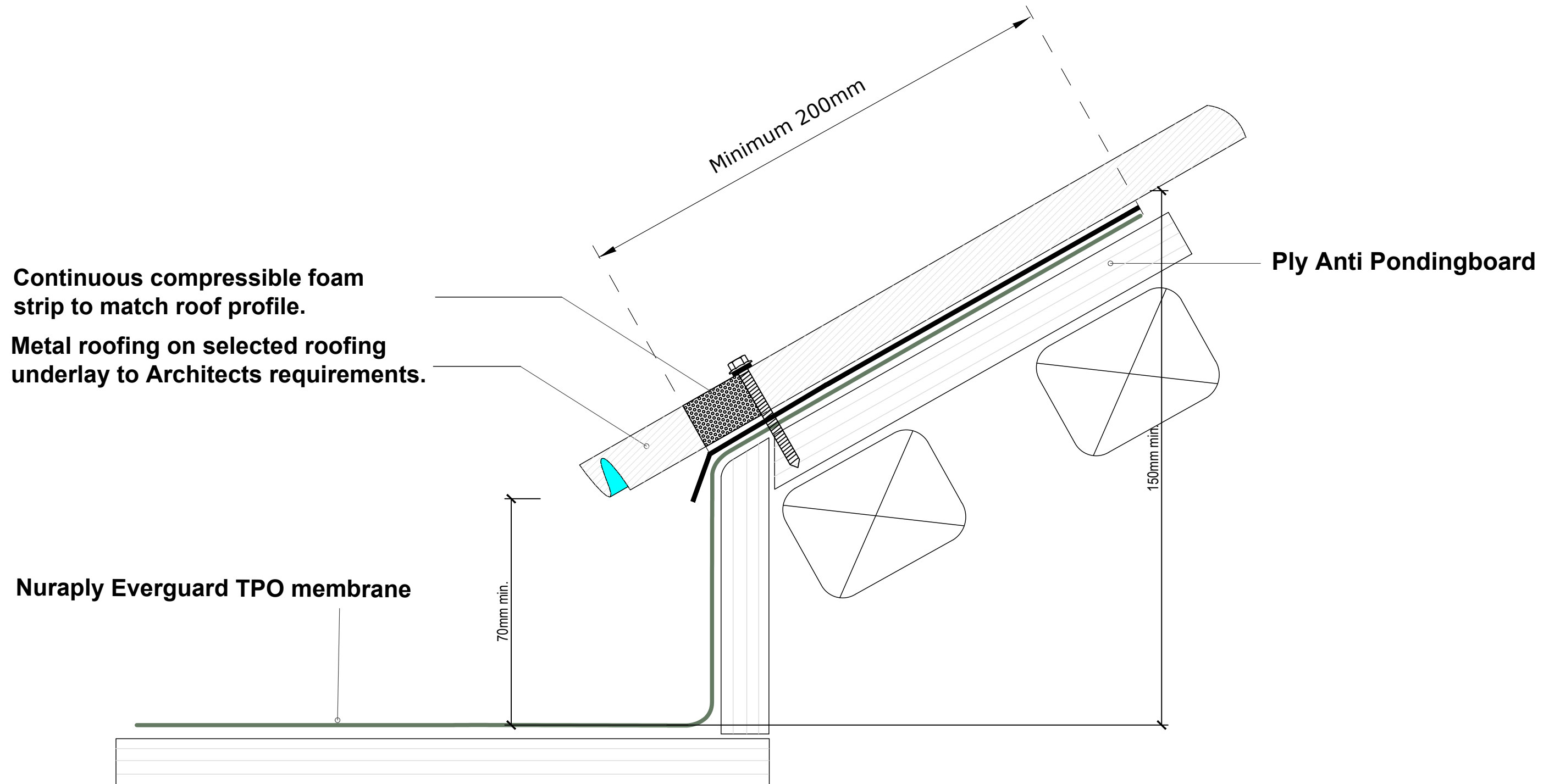

All Nuralite products/systems to be installed by an authorized Nuralite applicator and in accordance with Nuralite published instruction. Product data sheets should be consulted at all times. This drawing is a guide and is not for construction. This detail drawing is to be used only as part of the Nuralite specification package. All drawings are subject to copyright. Unauthorized use is prohibited. © Nuralite Waterproofing Ltd  
0800 - NURALITE (687254) [www.nuralite.co.nz](http://www.nuralite.co.nz)

PRODUCT/SYSTEM:

**NURAPLY EVERGUARD TPO**

DETAIL:

**METAL ROOF TO TPO TRANSITION**

SCALE: **NTS**

DATE: **JULY 2017**

PREVIOUS DWG no:

REVISION: -

DWG no: **ETPO.C1**

**THIS DRAWING IS INDICATIVE ONLY AND NOT FOR CONSTRUCTION  
FOR A TECHNICAL REVIEW OF SPECIFICATIONS AND PLANS , LODGE DOCUMENTS AT [WWW.NURALITE.CO.NZ/TECHCHECK/](http://WWW.NURALITE.CO.NZ/TECHCHECK/)**

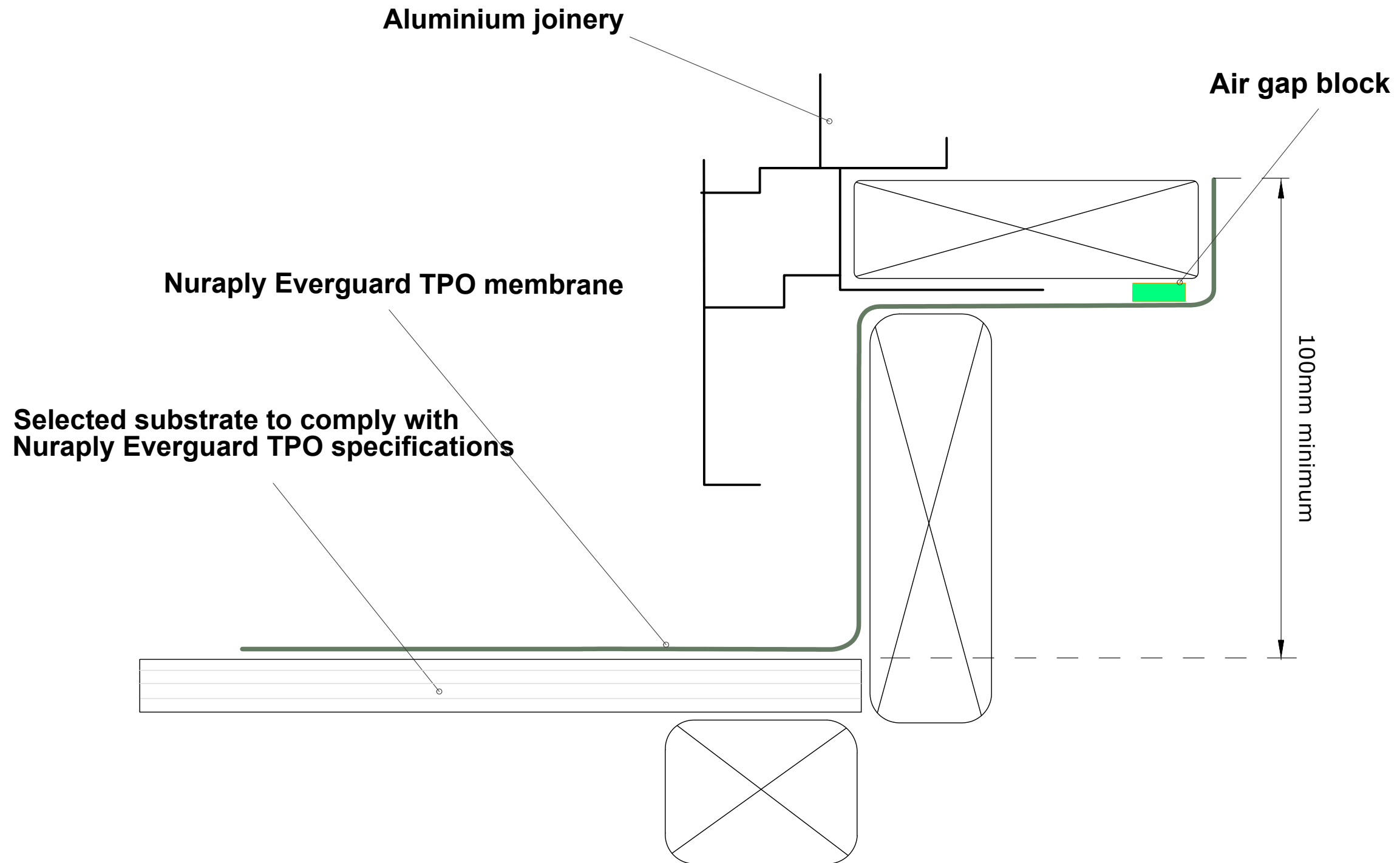

THIS DRAWING IS INDICATIVE ONLY AND NOT FOR CONSTRUCTION  
FOR A TECHNICAL REVIEW OF SPECIFICATIONS AND PLANS , LODGE DOCUMENTS AT [WWW.NURALITE.CO.NZ/TECHCHECK/](http://WWW.NURALITE.CO.NZ/TECHCHECK/)

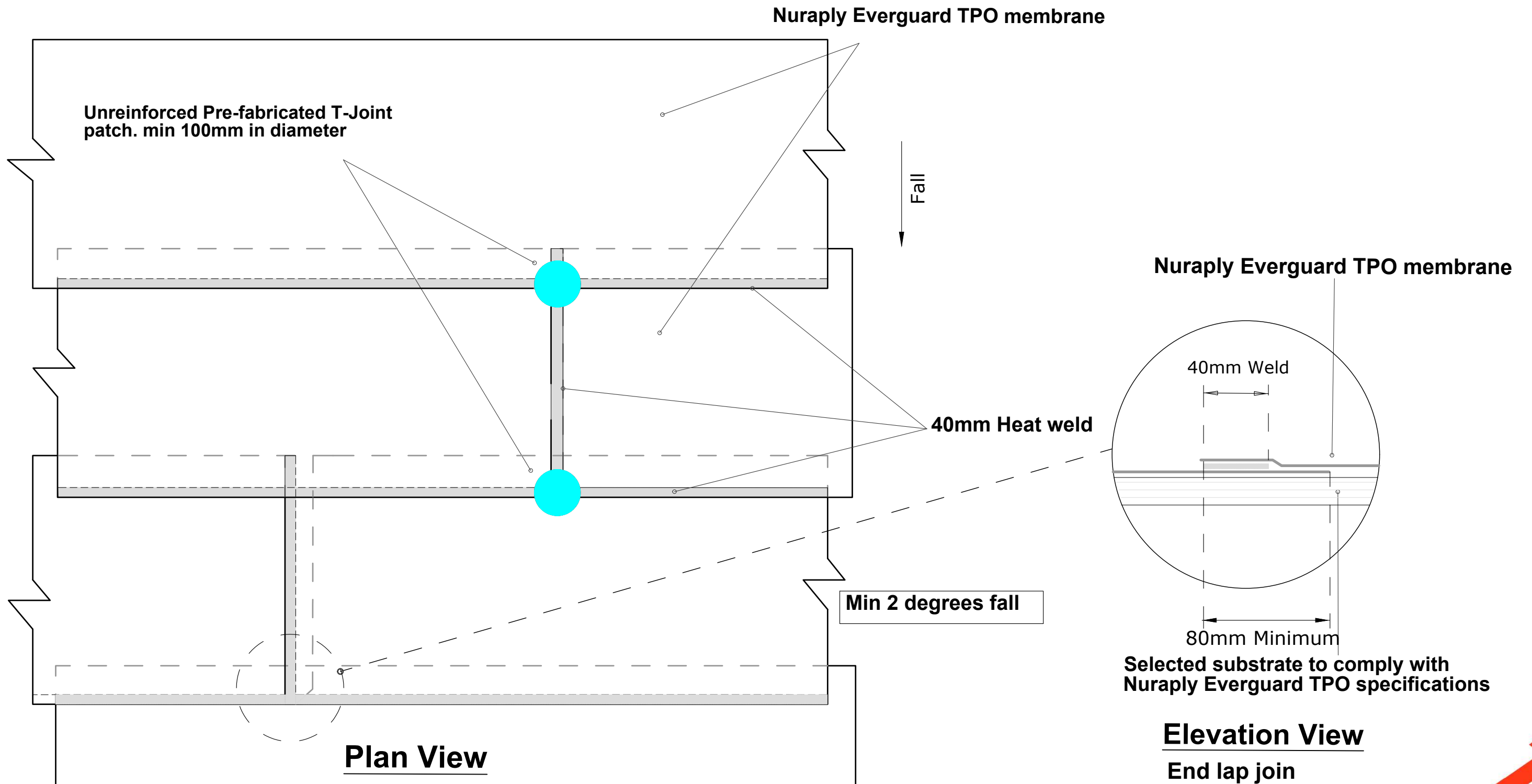



**THIS DRAWING IS INDICATIVE ONLY AND NOT FOR CONSTRUCTION  
FOR A TECHNICAL REVIEW OF SPECIFICATIONS AND PLANS , LODGE DOCUMENTS AT [WWW.NURALITE.CO.NZ/TECHCHECK/](http://WWW.NURALITE.CO.NZ/TECHCHECK/)**

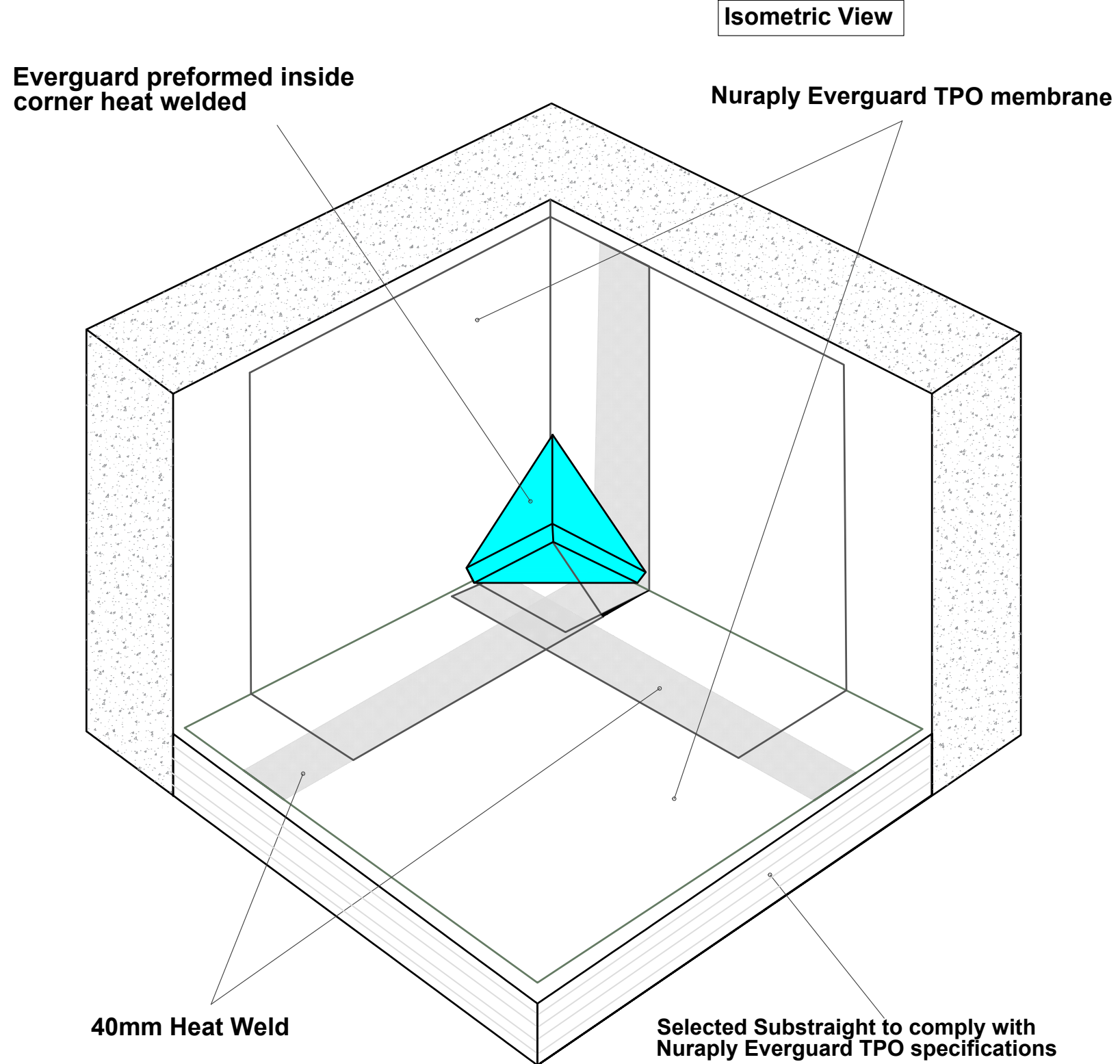

**THIS DRAWING IS INDICATIVE ONLY AND NOT FOR CONSTRUCTION  
FOR A TECHNICAL REVIEW OF SPECIFICATIONS AND PLANS , LODGE DOCUMENTS AT [WWW.NURALITE.CO.NZ/TECHCHECK/](http://WWW.NURALITE.CO.NZ/TECHCHECK/)**

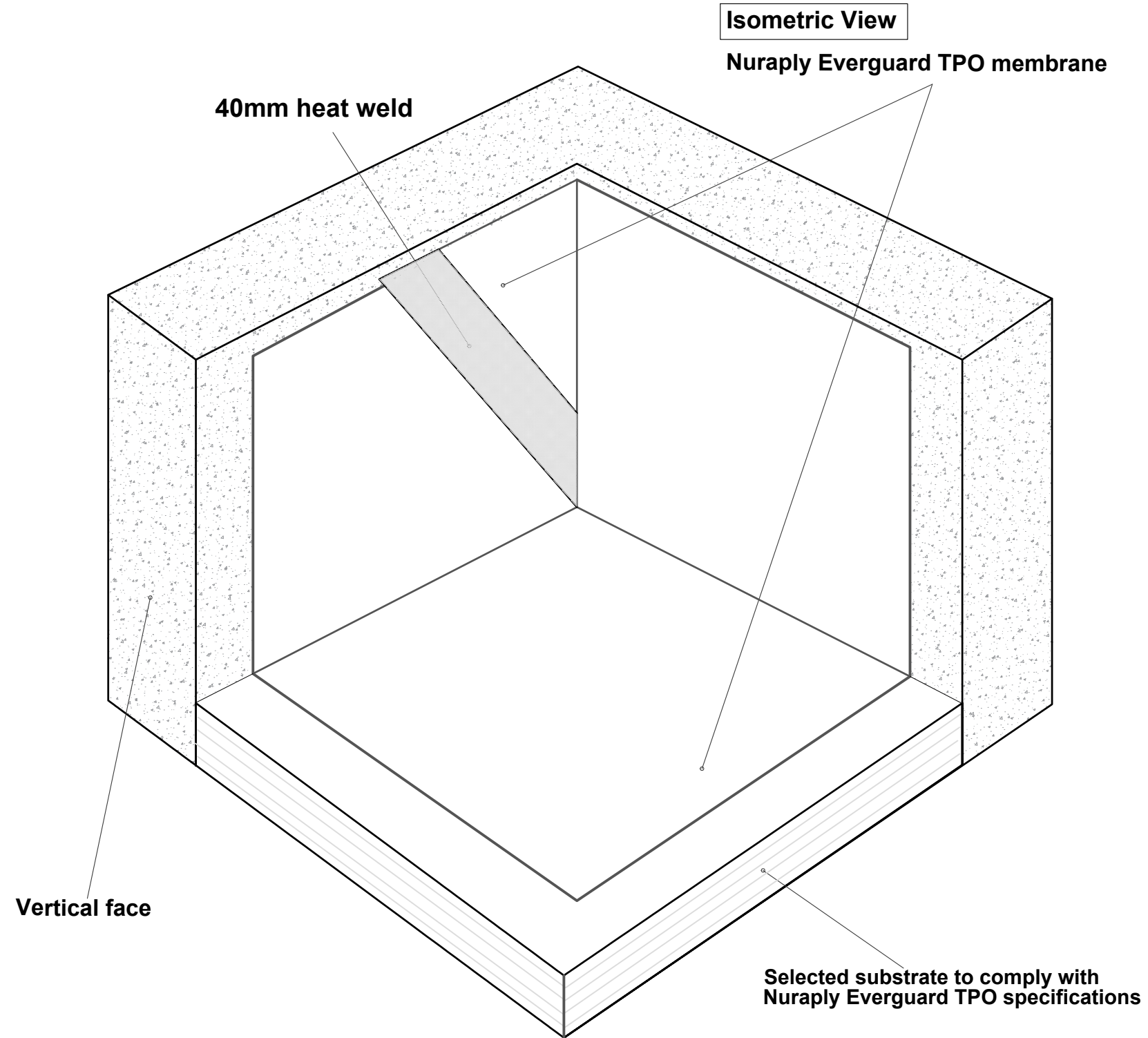

**THIS DRAWING IS INDICATIVE ONLY AND NOT FOR CONSTRUCTION  
FOR A TECHNICAL REVIEW OF SPECIFICATIONS AND PLANS , LODGE DOCUMENTS AT [WWW.NURALITE.CO.NZ/TECHCHECK/](http://WWW.NURALITE.CO.NZ/TECHCHECK/)**

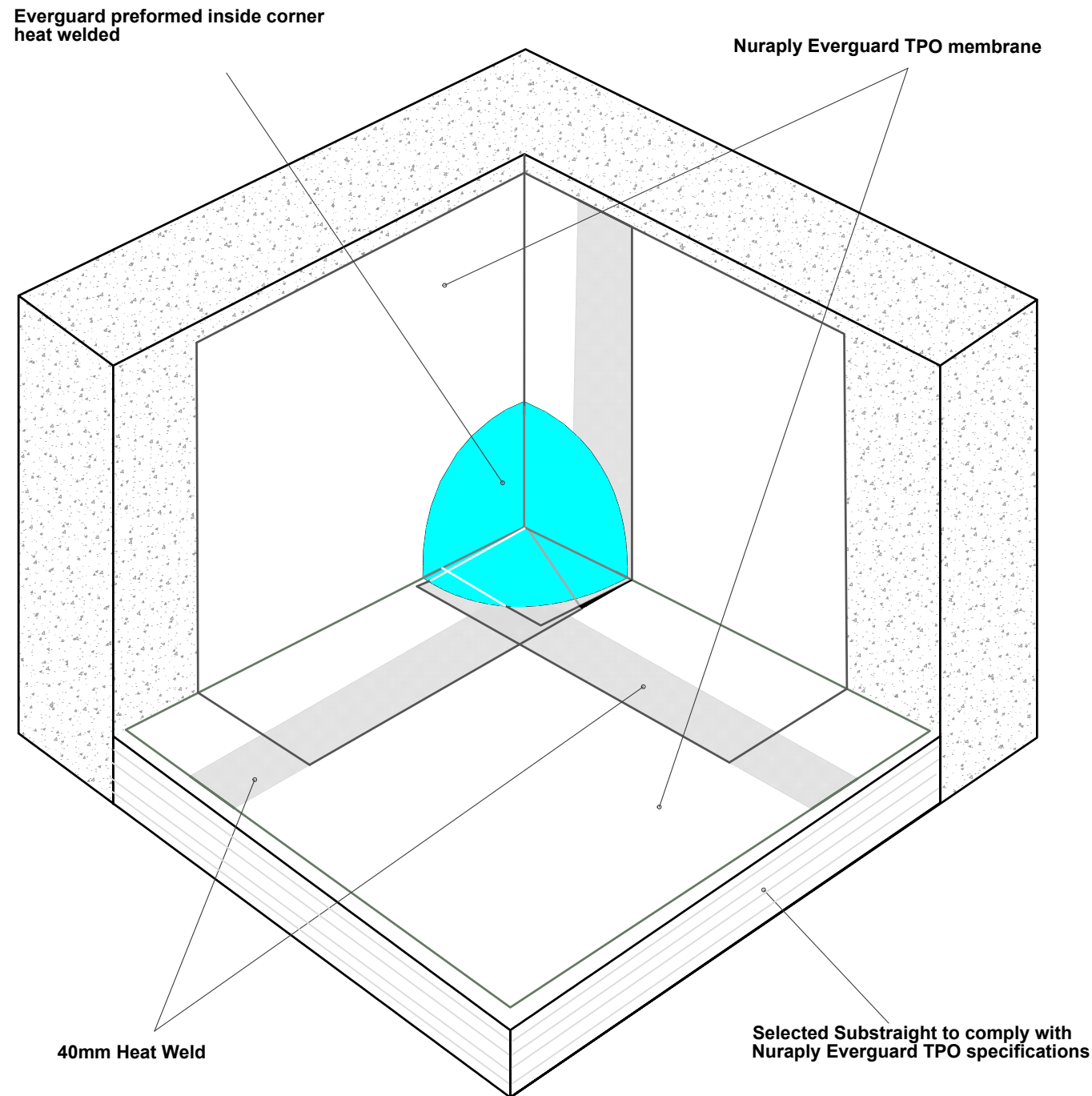

**Everguard TPO field fabricated cut from non-reinforced membrane**

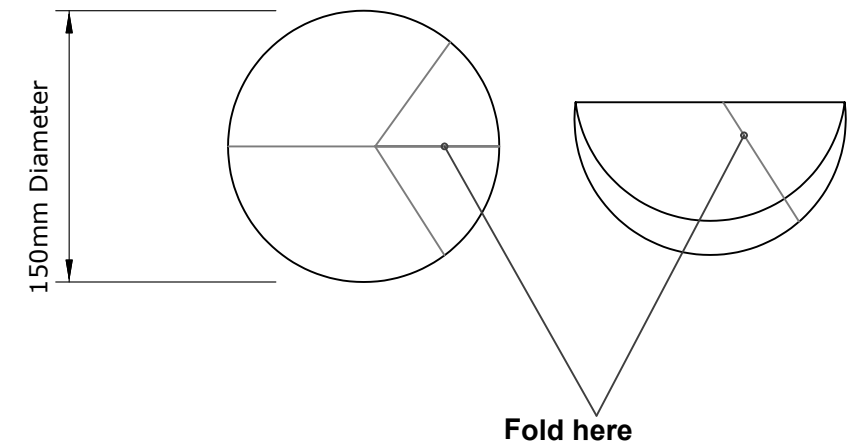

**Open the two sides.**

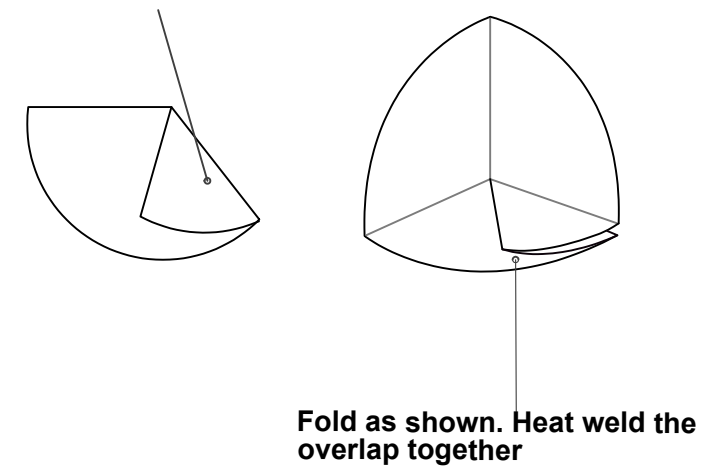

**THIS DRAWING IS INDICATIVE ONLY AND NOT FOR CONSTRUCTION  
FOR A TECHNICAL REVIEW OF SPECIFICATIONS AND PLANS , LODGE DOCUMENTS AT [WWW.NURALITE.CO.NZ/TECHCHECK/](http://WWW.NURALITE.CO.NZ/TECHCHECK/)**

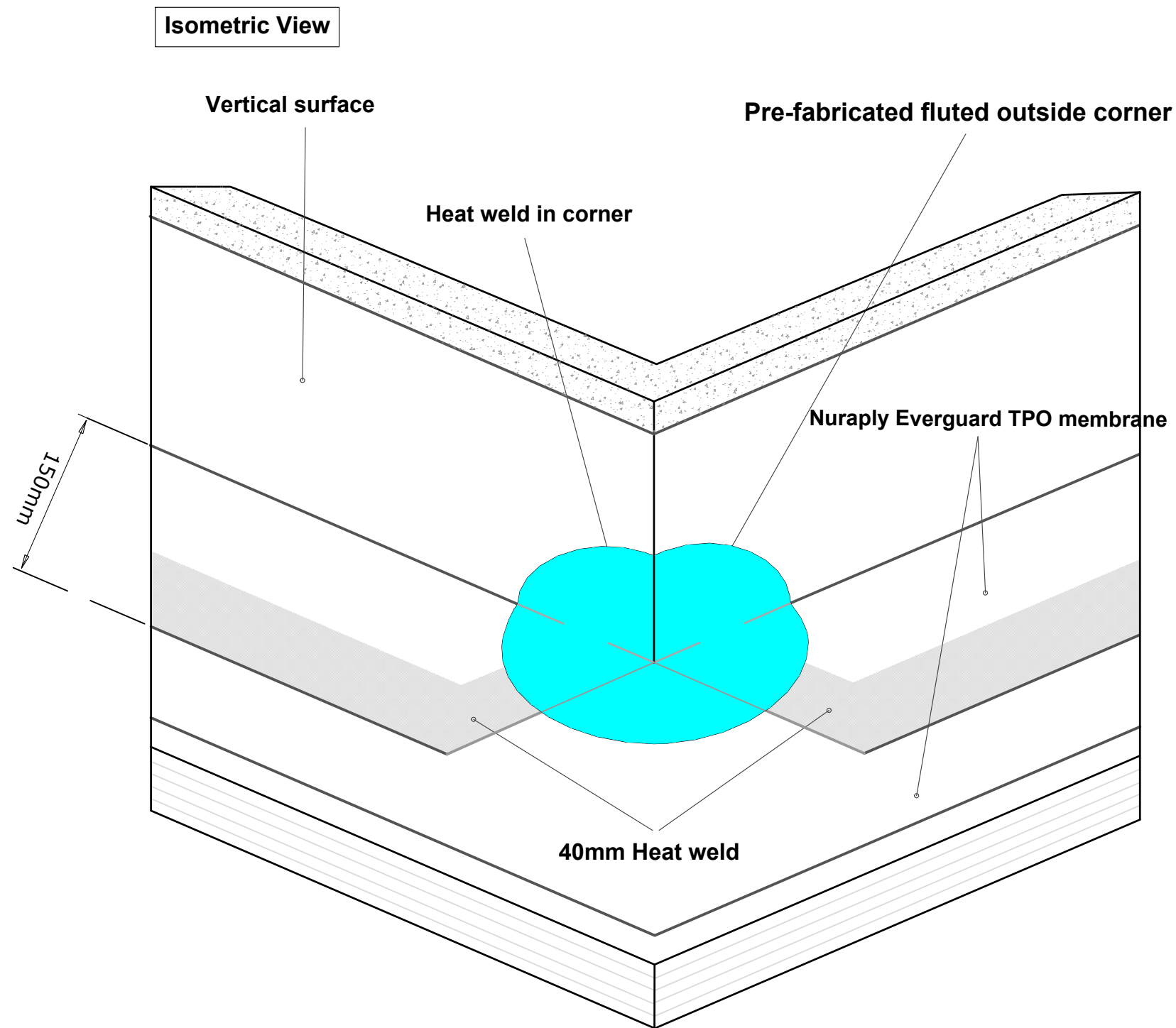

All Nuralite products/systems to be installed by an authorized Nuralite applicator and in accordance with Nuralite published instruction. Product data sheets should be consulted at all times. This drawing is a guide and is not for construction. This detail drawing is to be used only as part of the Nuralite specification package. All drawings are subject to copyright. Unauthorized use is prohibited. © Nuralite Waterproofing Ltd  
0800 - NURALITE (687254) [www.nuralite.co.nz](http://www.nuralite.co.nz)

PRODUCT/SYSTEM:	<b>NURAPLY EVERGUARD TPO</b>		
DETAIL:	FLUTED OUTSIDE CORNER		
SCALE: <b>NTS</b>	DATE: <b>JULY 2017</b>	PREVIOUS DWG no:	REVISION: -
			DWG no: <b>ETPO.D5</b>



THIS DRAWING IS INDICATIVE ONLY AND NOT FOR CONSTRUCTION  
 FOR A TECHNICAL REVIEW OF SPECIFICATIONS AND PLANS , LODGE DOCUMENTS AT [WWW.NURALITE.CO.NZ/TECHCHECK/](http://WWW.NURALITE.CO.NZ/TECHCHECK/)

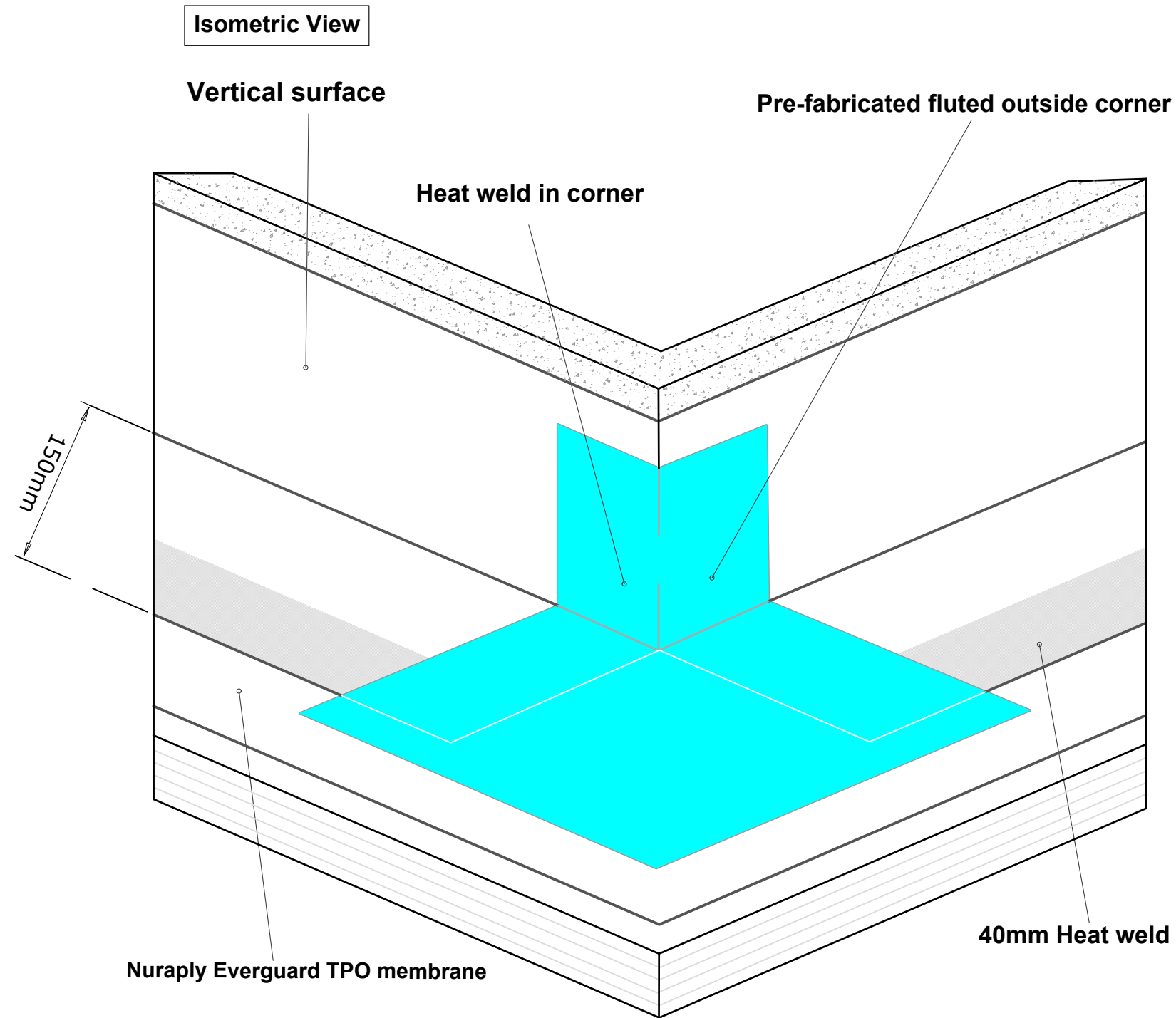

All Nuralite products/systems to be installed by an authorized Nuralite applicator and in accordance with Nuralite published instruction. Product data sheets should be consulted at all times. This drawing is a guide and is not for construction. This detail drawing is to be used only as part of the Nuralite specification package. All drawings are subject to copyright. Unauthorized use is prohibited. © Nuralite Waterproofing Ltd  
 0800 - NURALITE (687254) www.nuralite.co.nz

PRODUCT/SYSTEM:	<b>NURAPLY EVERGUARD TPO</b>		
DETAIL:	WALL CURB OUTSIDE CORNER		
SCALE: <b>NTS</b>	DATE: <b>JULY 2017</b>	PREVIOUS DWG no:	REVISION: -
			DWG no: <b>ETPO.D6</b>



**THIS DRAWING IS INDICATIVE ONLY AND NOT FOR CONSTRUCTION  
FOR A TECHNICAL REVIEW OF SPECIFICATIONS AND PLANS , LODGE DOCUMENTS AT [WWW.NURALITE.CO.NZ/TECHCHECK/](http://WWW.NURALITE.CO.NZ/TECHCHECK/)**

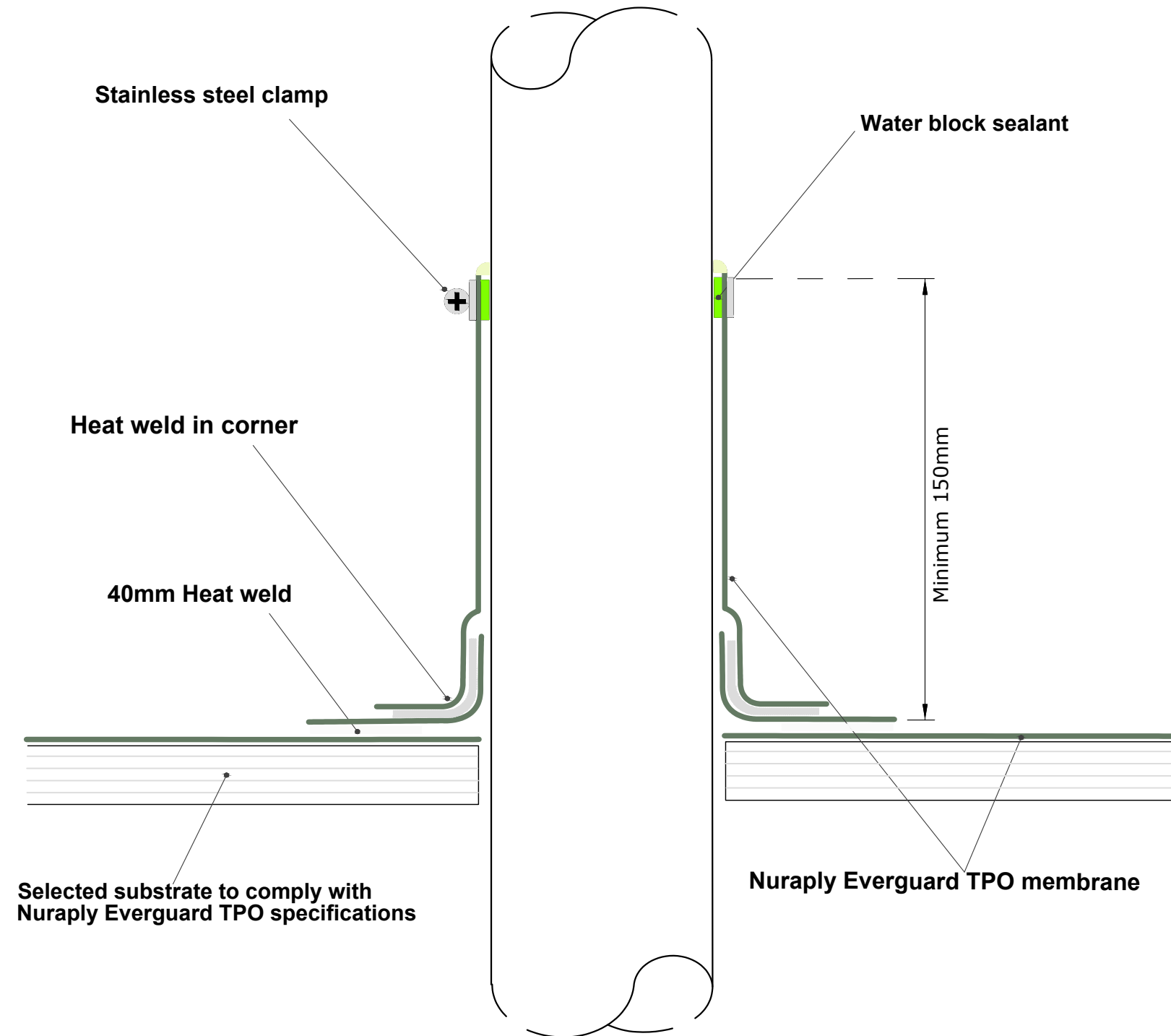

All Nuralite products/systems to be installed by an authorized Nuralite applicator and in accordance with Nuralite published instruction. Product data sheets should be consulted at all times. This drawing is a guide and is not for construction. This detail drawing is to be used only as part of the Nuralite specification package. All drawings are subject to copyright. Unauthorized use is prohibited. © Nuralite Waterproofing Ltd  
0800 - NURALITE (687254) [www.nuralite.co.nz](http://www.nuralite.co.nz)

PRODUCT/SYSTEM:	<b>NURAPLY EVERGUARD TPO</b>			
DETAIL:	<b>PIPE PENETRATION</b>			
SCALE: <b>NTS</b>	DATE: <b>JULY 2017</b>	PREVIOUS DWG no:	REVISION: -	DWG no: <b>ETPO.E1</b>

**THIS DRAWING IS INDICATIVE ONLY AND NOT FOR CONSTRUCTION  
FOR A TECHNICAL REVIEW OF SPECIFICATIONS AND PLANS , LODGE DOCUMENTS AT WWW.NURALITE.CO.NZ/TECHCHECK/**

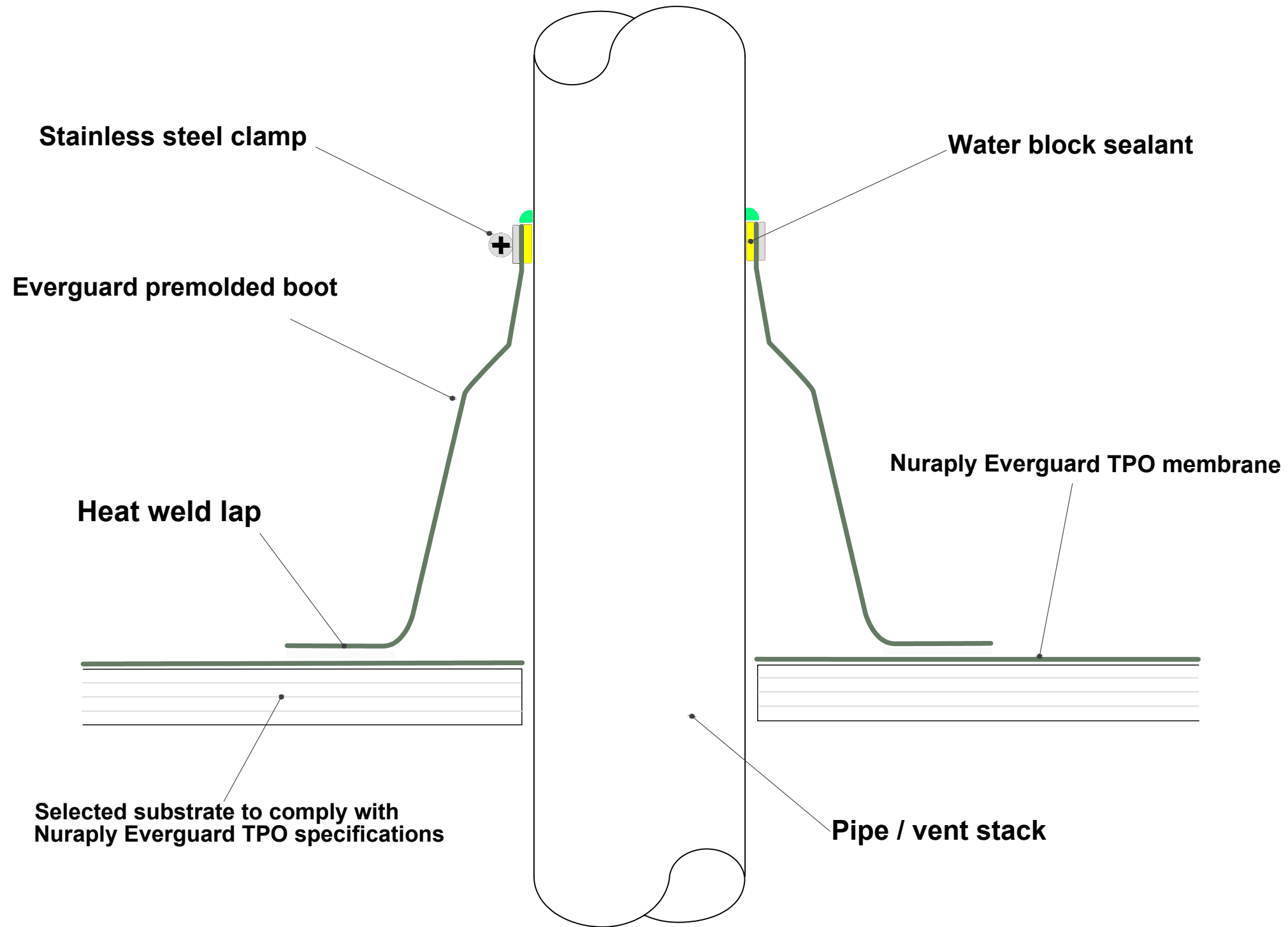

All Nuralite products/systems to be installed by an authorized Nuralite applicator and in accordance with Nuralite published instruction. Product data sheets should be consulted at all times. This drawing is a guide and is not for construction. This detail drawing is to be used only as part of the Nuralite specification package. All drawings are subject to copyright. Unauthorized use is prohibited. © Nuralite Waterproofing Ltd  
0800 - NURALITE (687254) www.nuralite.co.nz

PRODUCT/SYSTEM:	<b>NURAPLY EVERGUARD TPO</b>		
DETAIL:	PREMOLDED PIPE BOOT		
SCALE: <b>NTS</b>	DATE: <b>JULY 2017</b>	PREVIOUS DWG no:	REVISION: -
			DWG no: <b>ETPO.E2</b>

**THIS DRAWING IS INDICATIVE ONLY AND NOT FOR CONSTRUCTION  
FOR A TECHNICAL REVIEW OF SPECIFICATIONS AND PLANS , LODGE DOCUMENTS AT [WWW.NURALITE.CO.NZ/TECHCHECK/](http://WWW.NURALITE.CO.NZ/TECHCHECK/)**

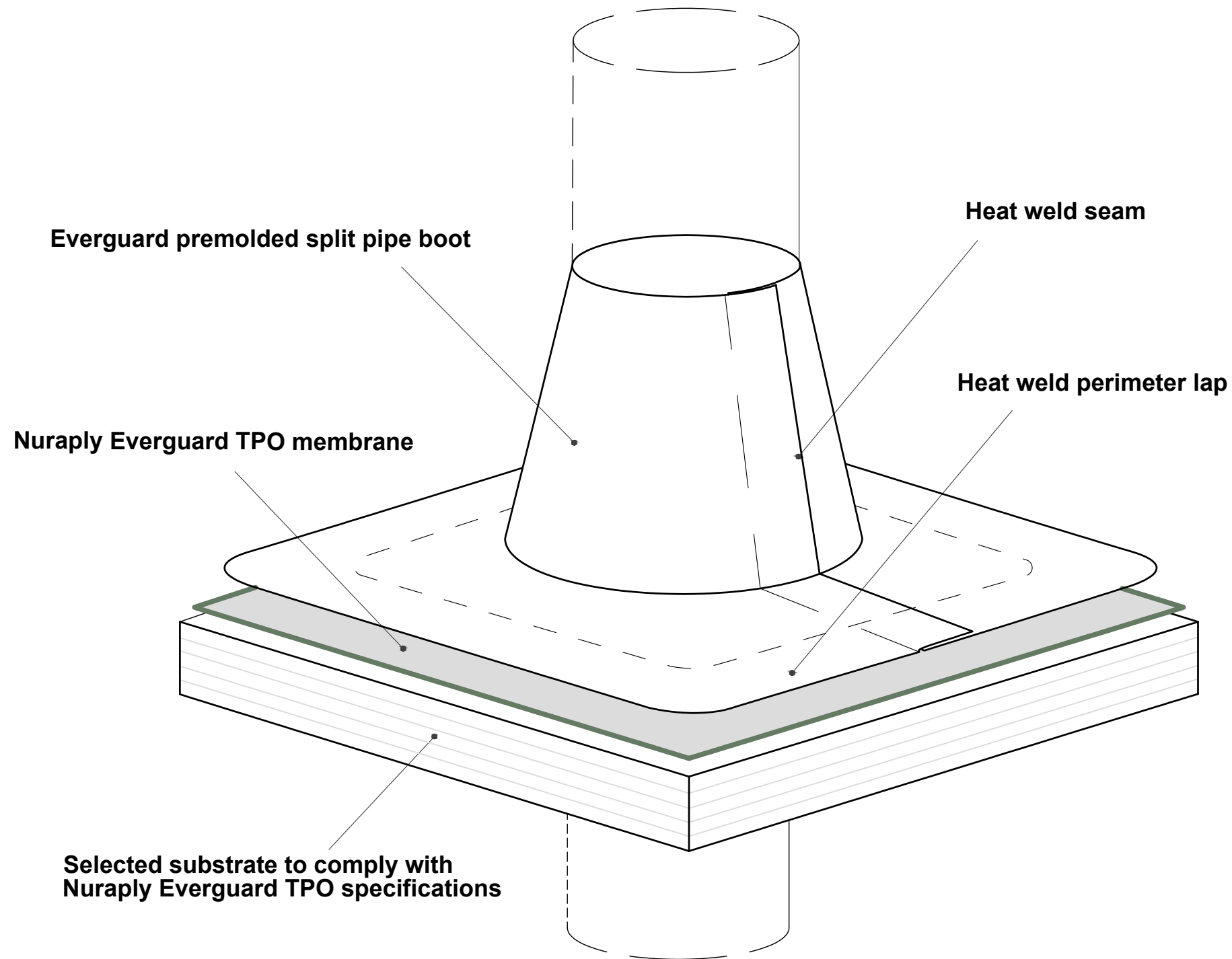

**THIS DRAWING IS INDICATIVE ONLY AND NOT FOR CONSTRUCTION  
FOR A TECHNICAL REVIEW OF SPECIFICATIONS AND PLANS , LODGE DOCUMENTS AT [WWW.NURALITE.CO.NZ/TECHCHECK/](http://WWW.NURALITE.CO.NZ/TECHCHECK/)**

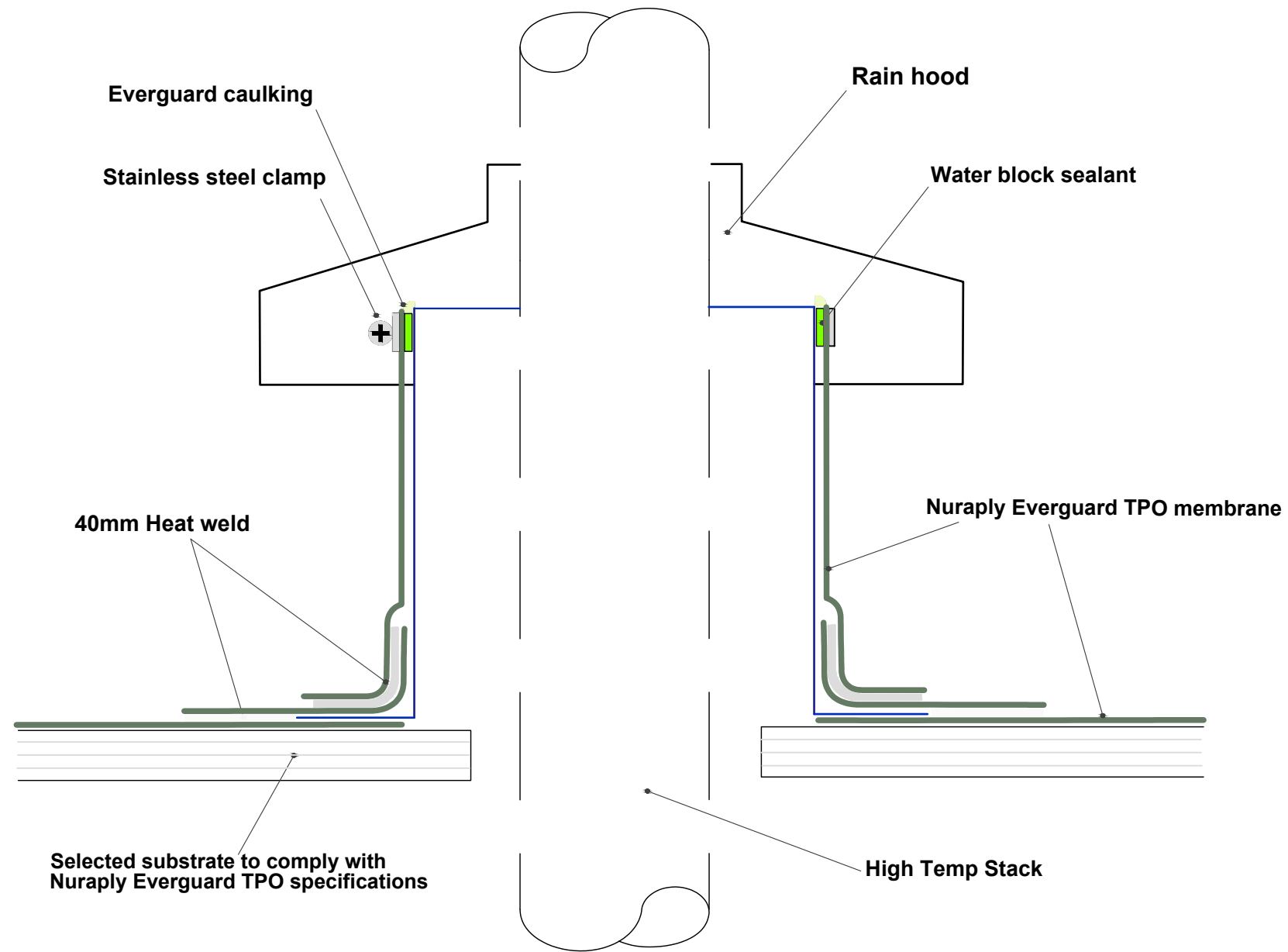

**THIS DRAWING IS INDICATIVE ONLY AND NOT FOR CONSTRUCTION  
FOR A TECHNICAL REVIEW OF SPECIFICATIONS AND PLANS , LODGE DOCUMENTS AT [WWW.NURALITE.CO.NZ/TECHCHECK/](http://WWW.NURALITE.CO.NZ/TECHCHECK/)**

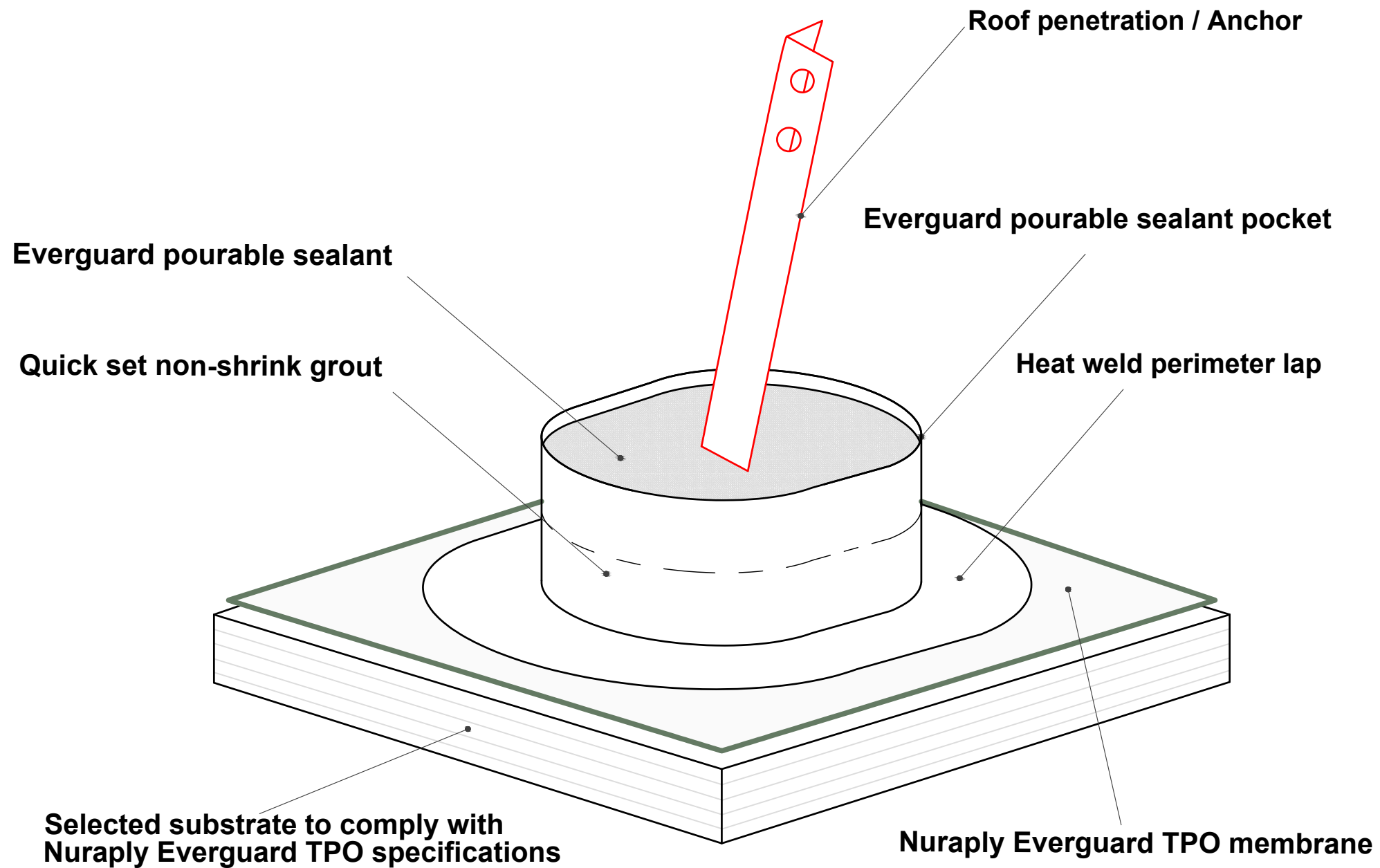

All Nuralite products/systems to be installed by an authorized Nuralite applicator and in accordance with Nuralite published instruction. Product data sheets should be consulted at all times. This drawing is a guide and is not for construction. This detail drawing is to be used only as part of the Nuralite specification package. All drawings are subject to copyright. Unauthorized use is prohibited. © Nuralite Waterproofing Ltd  
0800 - NURALITE (687254) [www.nuralite.co.nz](http://www.nuralite.co.nz)

PRODUCT/SYSTEM:	<b>NURAPLY EVERGUARD TPO</b>		
DETAIL:	POURABLE SEALANT POCKET		
SCALE: <b>NTS</b>	DATE: <b>JULY 2017</b>	PREVIOUS DWG no:	REVISION: -
			DWG no: <b>ETPO.E5</b>



THIS DRAWING IS INDICATIVE ONLY AND NOT FOR CONSTRUCTION  
 FOR A TECHNICAL REVIEW OF SPECIFICATIONS AND PLANS , LODGE DOCUMENTS AT [WWW.NURALITE.CO.NZ/TECHCHECK/](http://WWW.NURALITE.CO.NZ/TECHCHECK/)

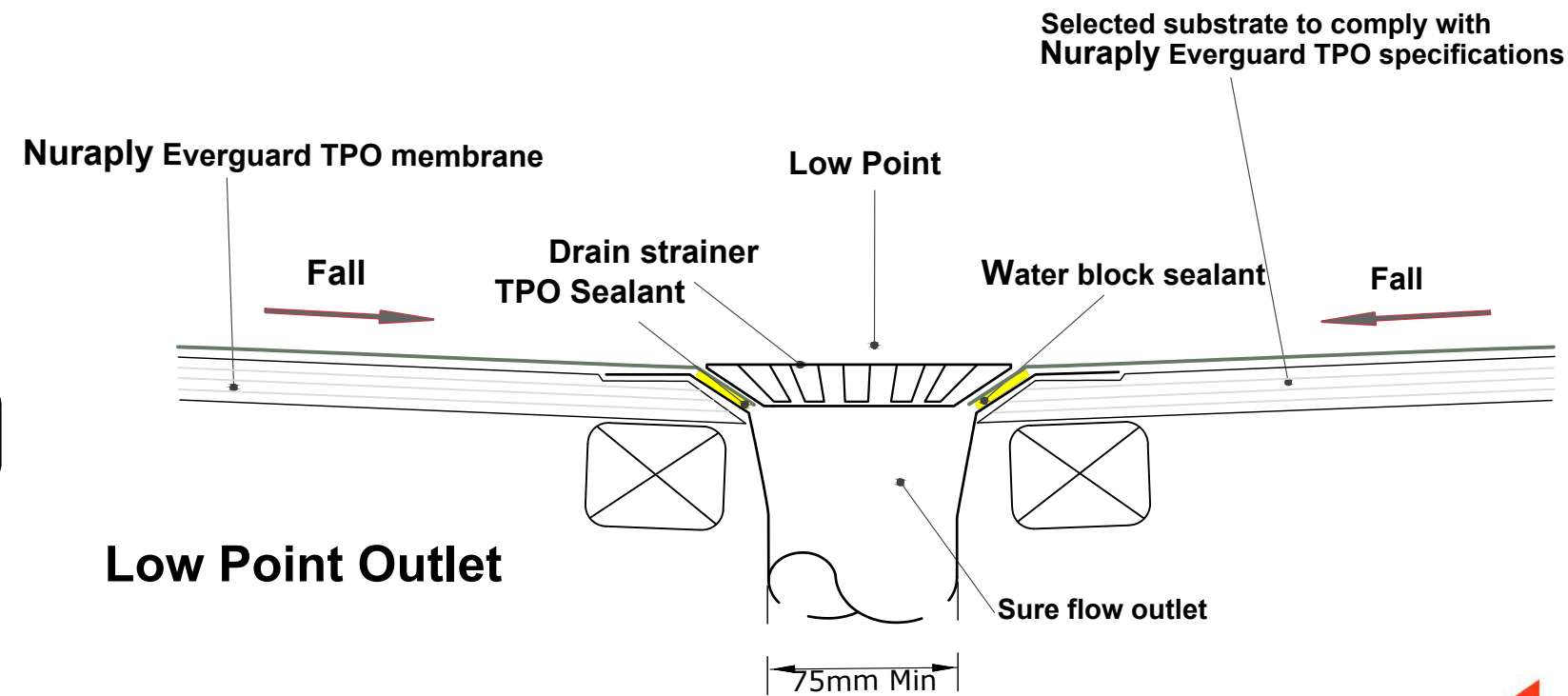
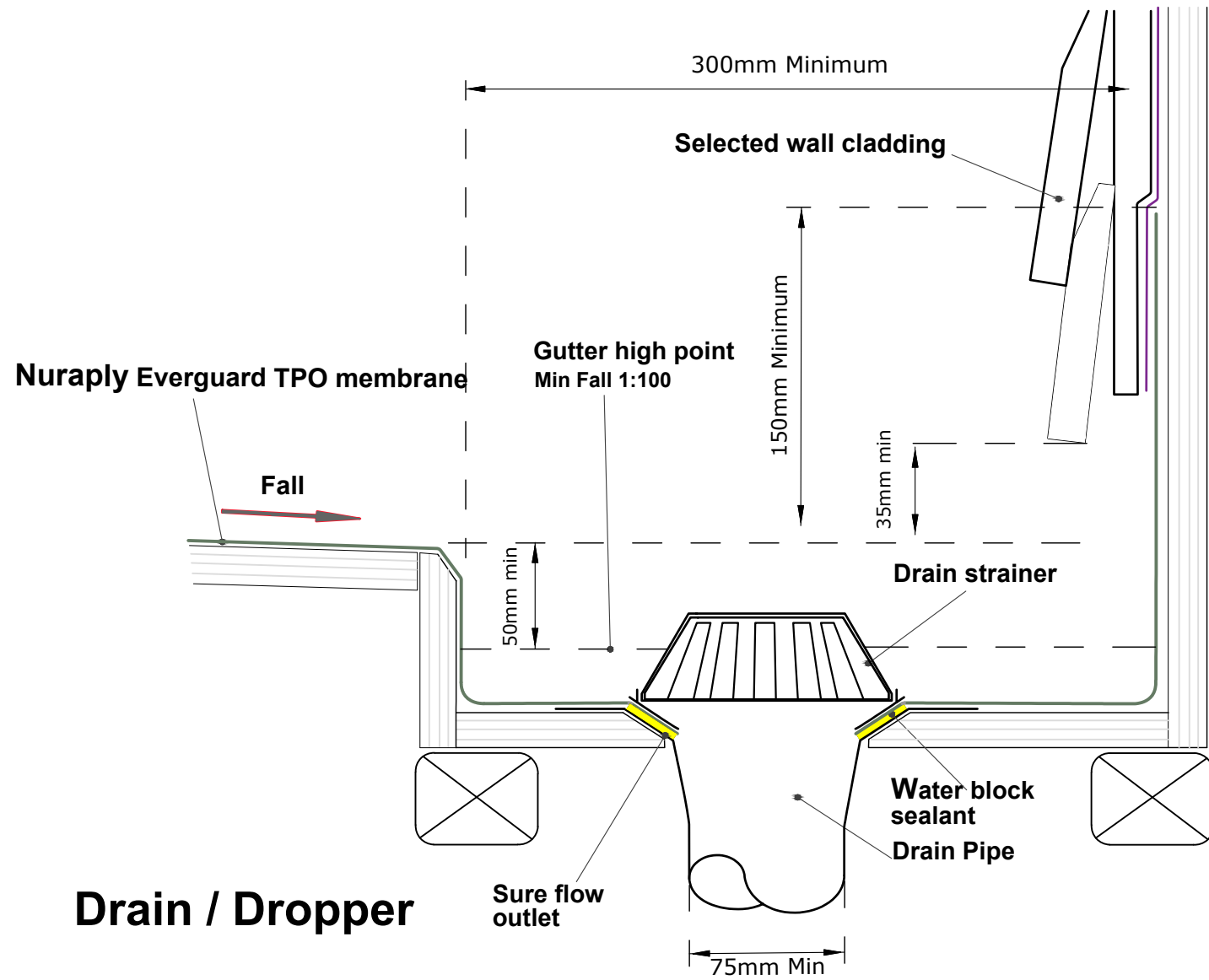

All Nuralite products/systems to be installed by an authorized Nuralite applicator and in accordance with Nuralite published instruction. Product data sheets should be consulted at all times. This drawing is a guide and is not for construction. This detail drawing is to be used only as part of the Nuralite specification package. All drawings are subject to copyright. Unauthorized use is prohibited. © Nuralite Waterproofing Ltd  
 0800 - NURALITE (687254) www.nuralite.co.nz

PRODUCT/SYSTEM:	<b>NURAPLY EVERGUARD TPO</b>			
DETAIL:	<b>DRAIN DROPPER</b>			
SCALE: <b>NTS</b>	DATE: <b>JULY 2017</b>	PREVIOUS DWG no:	REVISION: -	DWG no: <b>ETPO.E6</b>

**THIS DRAWING IS INDICATIVE ONLY AND NOT FOR CONSTRUCTION  
FOR A TECHNICAL REVIEW OF SPECIFICATIONS AND PLANS , LODGE DOCUMENTS AT [WWW.NURALITE.CO.NZ/TECHCHECK/](http://WWW.NURALITE.CO.NZ/TECHCHECK/)**

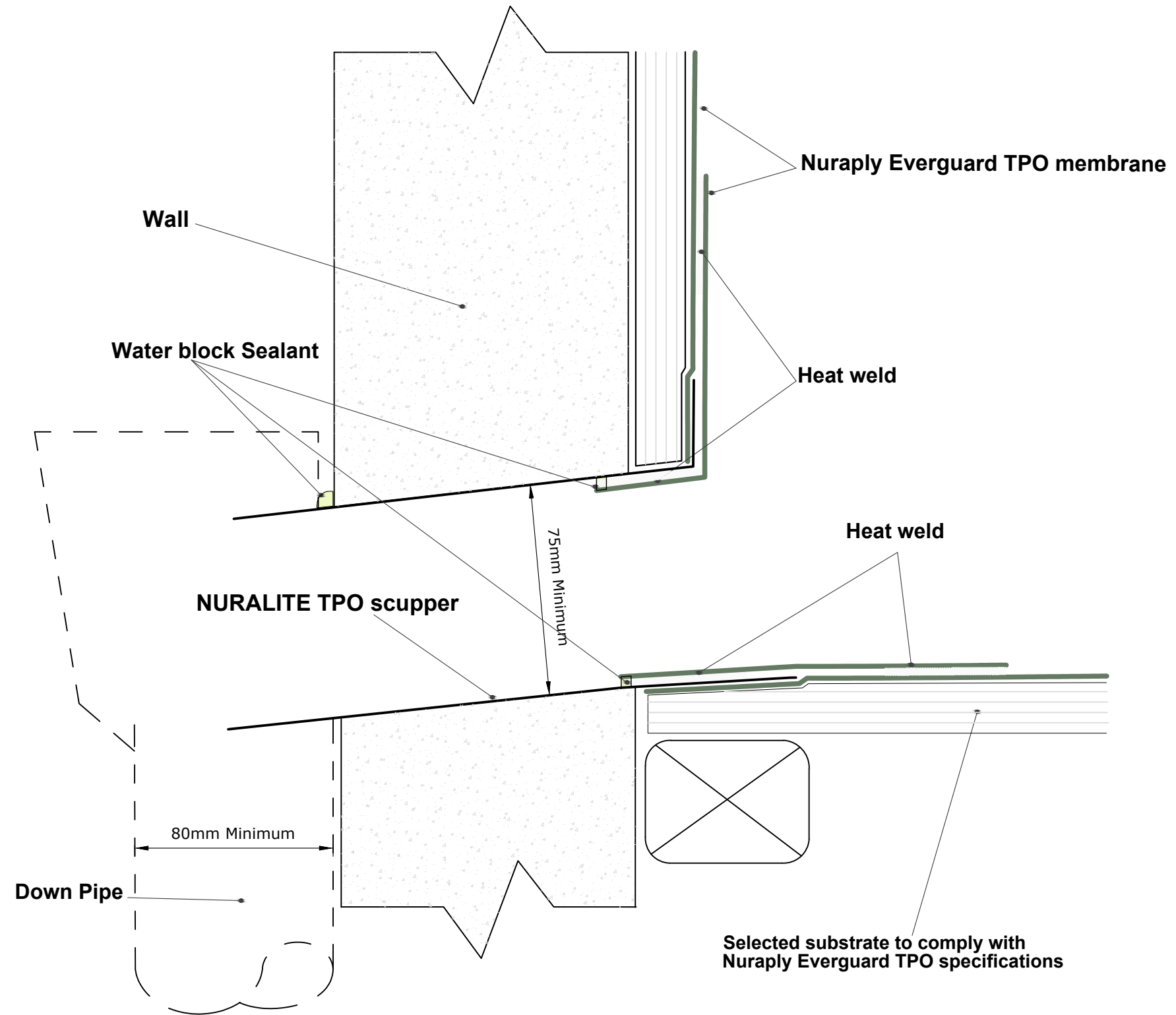

All Nuralite products/systems to be installed by an authorized Nuralite applicator and in accordance with Nuralite published instruction. Product data sheets should be consulted at all times. This drawing is a guide and is not for construction. This detail drawing is to be used only as part of the Nuralite specification package. All drawings are subject to copyright. Unauthorized use is prohibited. © Nuralite Waterproofing Ltd  
0800 - NURALITE (687254) www.nuralite.co.nz

PRODUCT/SYSTEM:	<b>NURAPLY EVERGUARD TPO</b>		
DETAIL:	TPO SCUPPER		
SCALE: <b>NTS</b>	DATE: <b>JULY 2017</b>	PREVIOUS DWG no:	REVISION: -
			DWG no: <b>ETPO.E7</b>



**THIS DRAWING IS INDICATIVE ONLY AND NOT FOR CONSTRUCTION  
FOR A TECHNICAL REVIEW OF SPECIFICATIONS AND PLANS , LODGE DOCUMENTS AT [WWW.NURALITE.CO.NZ/TECHCHECK/](http://WWW.NURALITE.CO.NZ/TECHCHECK/)**

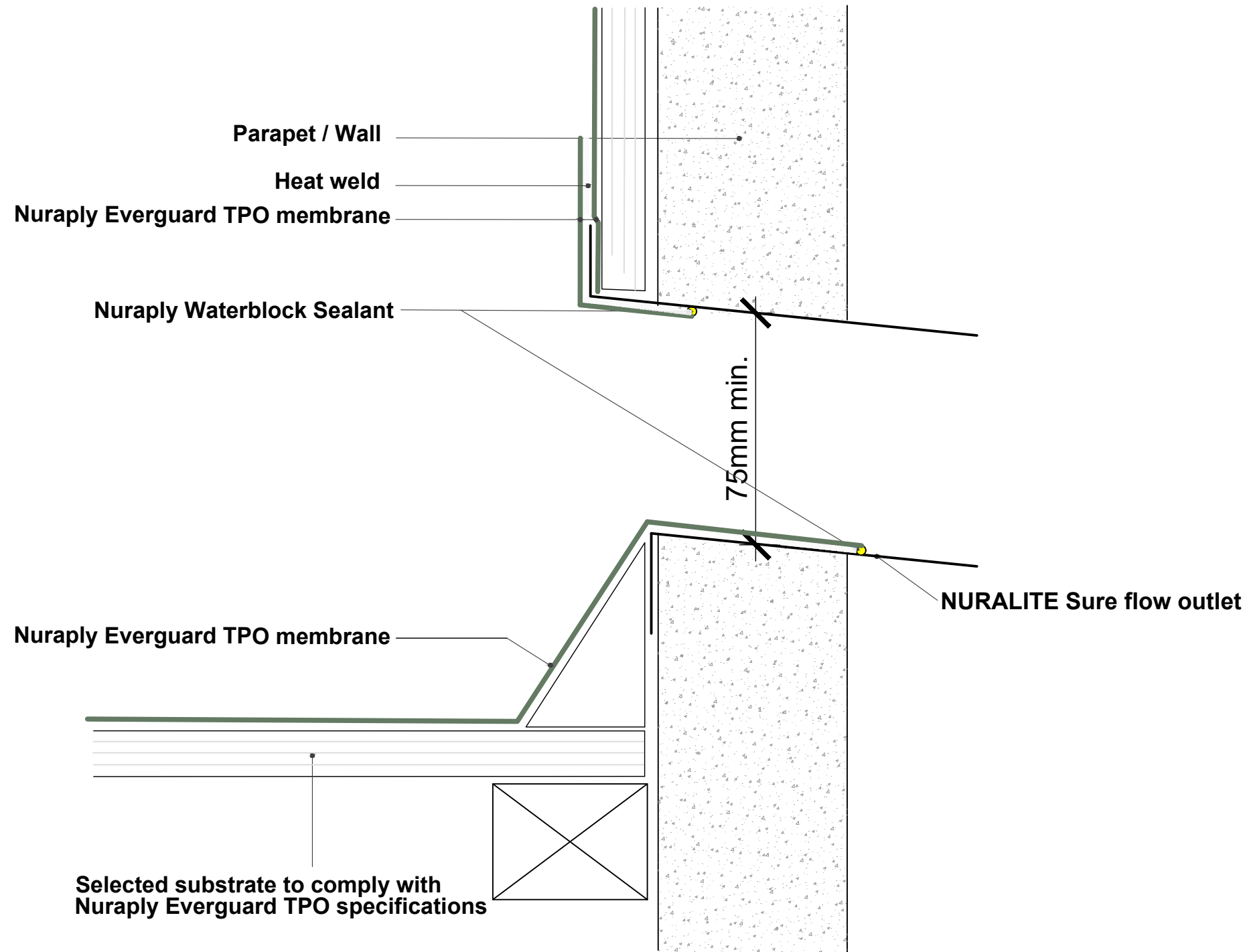

PRODUCT/SYSTEM:	<b>NURAPLY EVERGUARD TPO</b>		
DETAIL:	<b>OVERFLOW SCUPPER</b>		
SCALE: <b>NTS</b>	DATE: <b>JULY 2017</b>	PREVIOUS DWG no:	REVISION: -
			DWG no: <b>ETPO.E8</b>

THIS DRAWING IS INDICATIVE ONLY AND NOT FOR CONSTRUCTION  
 FOR A TECHNICAL REVIEW OF SPECIFICATIONS AND PLANS , LODGE DOCUMENTS AT [WWW.NURALITE.CO.NZ/TECHCHECK/](http://WWW.NURALITE.CO.NZ/TECHCHECK/)

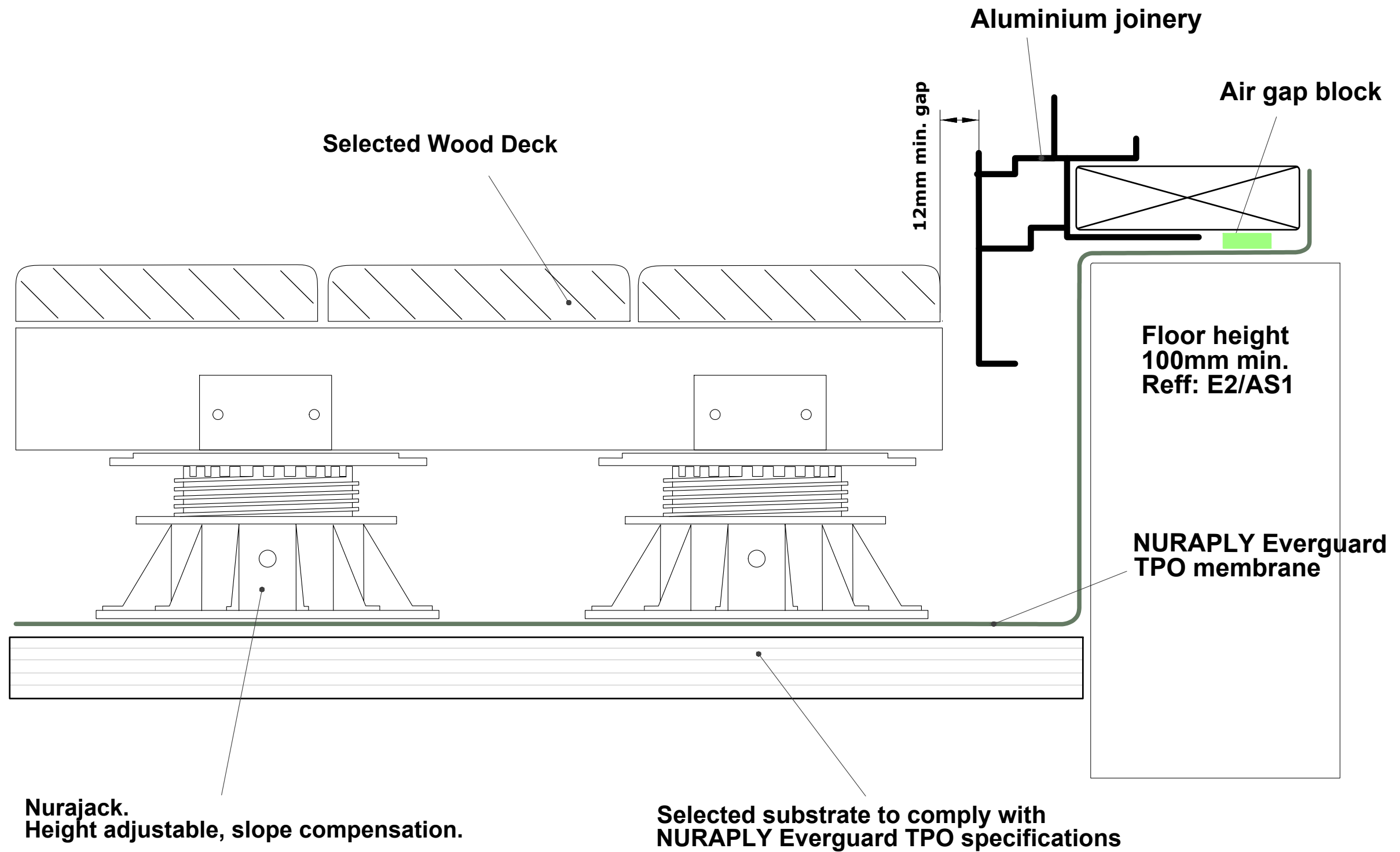

THIS DRAWING IS INDICATIVE ONLY AND NOT FOR CONSTRUCTION  
FOR A TECHNICAL REVIEW OF SPECIFICATIONS AND PLANS , LODGE DOCUMENTS AT [WWW.NURALITE.CO.NZ/TECHCHECK/](http://WWW.NURALITE.CO.NZ/TECHCHECK/)

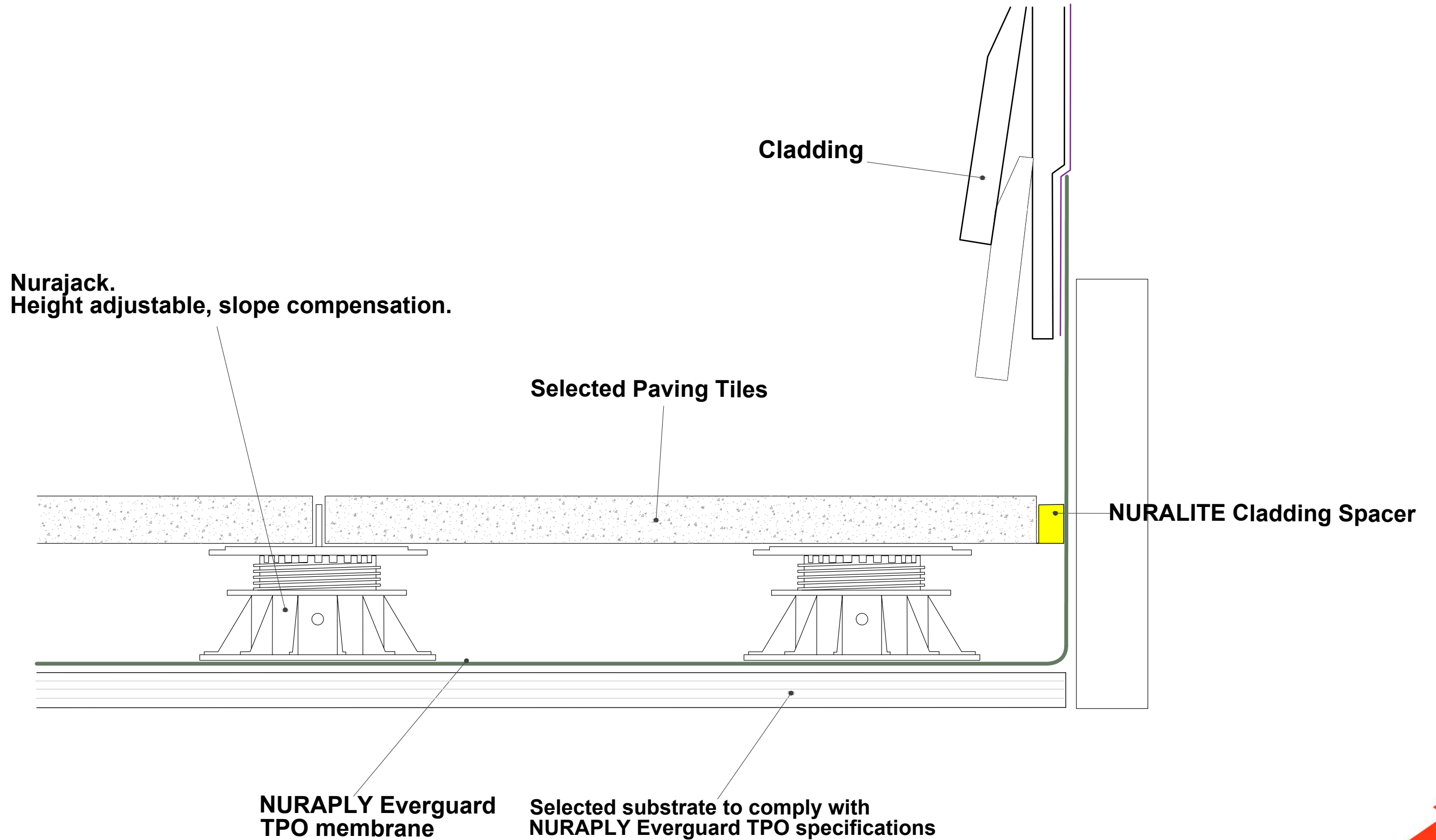



**THIS DRAWING IS INDICATIVE ONLY AND NOT FOR CONSTRUCTION  
FOR A TECHNICAL REVIEW OF SPECIFICATIONS AND PLANS , LODGE DOCUMENTS AT WWW.NURALITE.CO.NZ/TECHCHECK/**

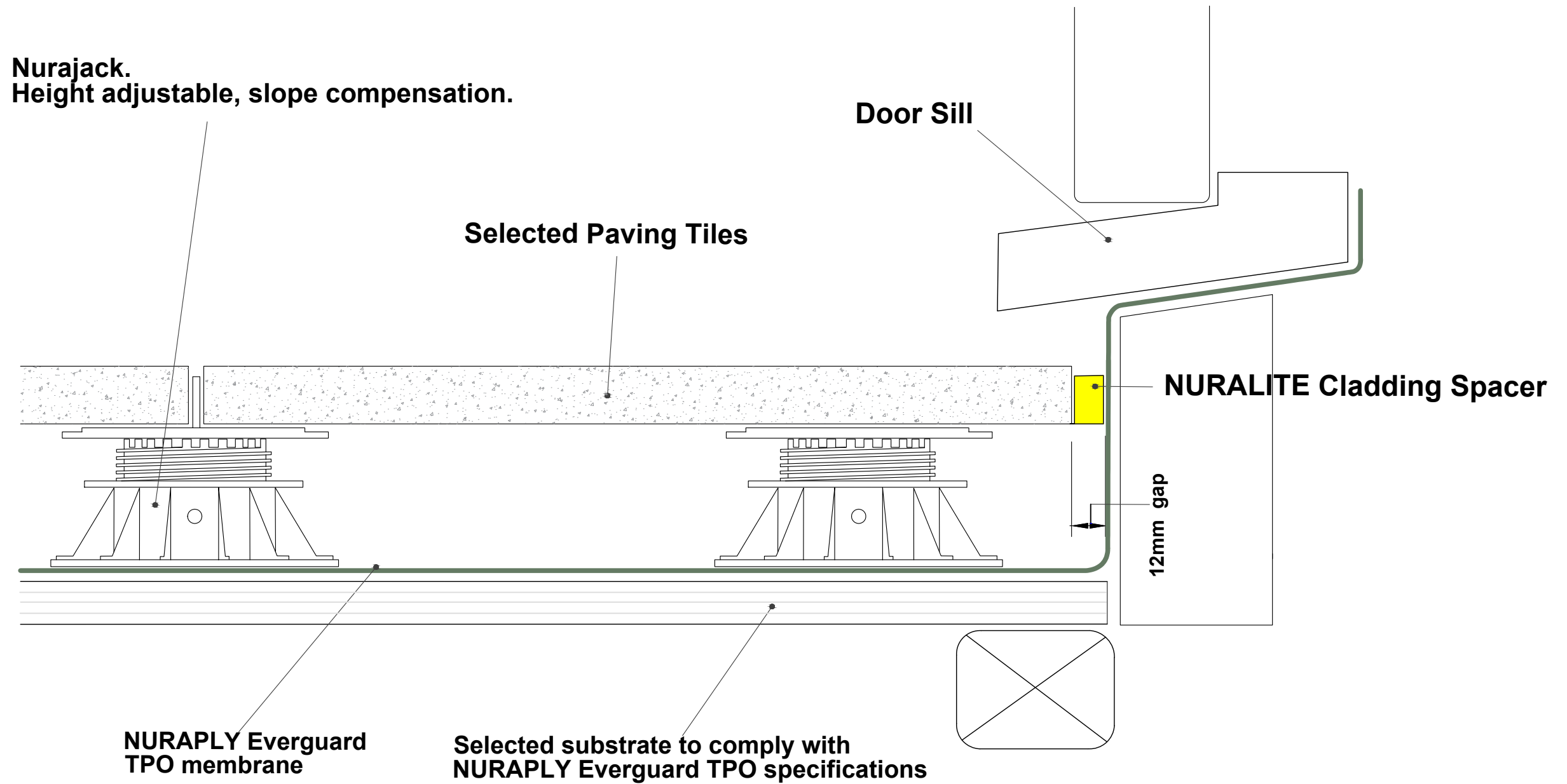

All Nuralite products/systems to be installed by an authorized Nuralite applicator and in accordance with Nuralite published instruction. Product data sheets should be consulted at all times. This drawing is a guide and is not for construction. This detail drawing is to be used only as part of the Nuralite specification package. All drawings are subject to copyright. Unauthorized use is prohibited. © Nuralite Waterproofing Ltd  
0800 - NURALITE (687254) www.nuralite.co.nz

PRODUCT/SYSTEM:	<b>NURAPLY EVERGUARD TPO</b>		
DETAIL:	<b>NURAJACK PEDESTAL DOOR SILL</b>		
SCALE: <b>NTS</b>	DATE: <b>JULY 2017</b>	PREVIOUS DWG no:	REVISION: -
			DWG no: <b>ETPO.F3</b>