

The logo for hebel, featuring the word "hebel" in a bold, blue, sans-serif font. To the right of the text is a stylized graphic element consisting of a series of small, light-colored squares arranged in a grid pattern, followed by a larger, light-colored rectangular shape that tapers to the right.

The better way to build

# PowerFloor Low Rise Residential & Commercial Floor System

DESIGN AND INSTALLATION GUIDE  
NEW ZEALAND

The CSR logo, consisting of the letters "CSR" in a bold, white, sans-serif font, enclosed within a white square border.

# Contents

## Introduction 3

### 1. Design and selection details 6

- How to use this design and Installation Guide 6
- System components 8
- Design considerations 10
- Architectural Specification 11

### 2. System performance 13

- System properties 13
- Building regulations 15
- Joist span tables 16

### 3. Installation detail 21

- Hebel PowerFloor installation sequence 21
- Construction details 22
- Hebel PowerFloor panel fixing details 26
- Control joint details 28
- Construction Details 29
- Multi-Level Construction details 31
- Hold-down/bracing wall details 32
- Penetrations & notching details 33
- Wet area detail 33
- Balcony & staircase details 34
- Floor covering installation 36
- Tile installation 36
- Vinyl installation 36
- Timber installation 37

### 4. Handling, storage and responsibility 38

- Delivery and storage 38
- Tools and equipment for construction 39
- Panel installation 40
- Panel handling 41

### Appendices 42

- Appendix A. Hebel PowerFloor panel material properties 42
- Appendix B. Estimating Hebel PowerFloor 43

This Design Guide has been prepared as a source of information to provide general guidance to consultants – and in no way replaces the services of the professional consultant and relevant engineers designing the project.

It is the responsibility of the architectural designer and engineering parties to ensure that the details in this Design and Installation Guide are appropriate for the intended application.

The recommendations of this guide are formulated along the lines of good building practice, but are not intended to be an exhaustive statement of all relevant data.

# Better floors are constructed with Hebel PowerFloor



Hebel is an Autoclaved Aerated Concrete (AAC) available as blocks and lightweight steel reinforced concrete panels. Hebel has been used in Europe for over 70 years and here in New Zealand for over 20 years.

## **Hebel reduces your total cost to build.**

Hebel is a unique high performance masonry system that is easy to install and speeds up construction time. The Hebel system can be installed without bricklayers and reduces the requirement for skilled trades-people on site. Whether you choose to install it yourself using existing trades or have it supplied and installed by readily available and experienced crews you will be happy with the cost savings.

## **Hebel Powerfloor. A high-performance lightweight concrete flooring system**

Hebel PowerFloor is a lightweight concrete flooring system ideal for installation over timber or steel joists.

This system provides a superior floor solution with the qualities and feel of a concrete floor at a significantly reduced cost.

Hebel PowerFloor panels are reinforced with corrosion-protected steel mesh and they feature tongue and grooved edges which fit snugly together to form a strong, solid and smooth floor suitable for just about any floor covering.

Hebel PowerFloor can be easily installed by existing on-site tradesmen such as carpenters and is unaffected by wet or changing weather during installation.

Unlike concrete, Hebel PowerFloor does not need propping or curing and is ready for application of floor finishes within 24hours.

## **Hebel. Supreme comfort, solid and quiet**

The Hebel PowerFloor system reduces airborne noise such as foot-fall from upper floors making for a quieter home. This is especially important given the trend away from carpet to hard flooring surfaces such as timber and tiles. Hebel PowerFloor also eliminates squeaking that is often the case with particle board and timber board flooring.

PowerFloor boasts superior thermal performance (particularly for suspended floors on sloping sites) and assists in achieving thermal ratings that result in reduced heating and cooling costs.

## **Made and distributed by CSR**

Hebel is manufactured in Australia to the highest quality standards and our warranty is backed by CSR, one of Australia's oldest companies, for your peace of mind. Hebel is distributed in New Zealand by CSR Hebel, a division of CSR Building Products (NZ) Ltd, a wholly owned subsidiary of CSR in Australia. Our systems have been developed in New Zealand to meet local requirements so you can rely on New Zealand and Australian expertise and stock holdings.

# Hebel PowerFloor. Better to build

At the heart of the Hebel system is the Hebel PowerFloor – a 75mm thick, steel reinforced building panel made from AAC (Autoclaved Aerated Concrete) supplied in 1800mm & 2400mm lengths by 600mm wide with a tongue and groove profile.

The unique Hebel attributes are best summarised with the Hebel 'tick' below:



## Faster construction period

Hebel PowerFloor is faster to construct than suspended concrete. No propping and curing of concrete is required. Typical placement rates of 70m<sup>2</sup> per day can be achieved with follow on trades starting after 24 hours.



## Lightweight yet solid and tough as concrete

Being a masonry, steel reinforced 75mm thick panel, Hebel PowerFloor is solid and strong. A lightweight concrete floor that can be easily laid by your normal on-site tradesmen such as carpenters.



## A comforting thought for a comfortable living environment

Hebel's unique AAC construction provides superior insulation qualities for a masonry product. The unique combination of thermal resistance along with thermal mass, make building with Hebel a smart choice for meeting New Zealand's stringent building regulations.

For unit and home owners, the thermal efficiencies of Hebel reduce the reliance on heating and cooling appliances – the combined effects of using a heater less in winter and fans or air conditioning less in summer and warmer months can have a big impact on rising energy costs.



# with...



### Highly fire resistant for peace of mind and added security

Hebel is non-combustible and renowned for its highly fire resistant properties. The fire rating of the floor system is determined by the ceiling linings achieving up to 120/120/120 minutes FRR when fire exposure is from the underside (BRANZ FC13639-001).



### A sound reason for better acoustic qualities

Hebel PowerFloor answers the age old issue of sound transfer between floors. Creaking timber is a thing of the past as the tongue and groove solid concrete floor locks together. PowerFloor provides superior airborne noise insulation particularly good for foot fall noise when installed with resilient mounts. With home theatres becoming standard in most modern homes, you can enjoy your entertainment without disturbing the rest of the family.



### Sustainability for a better world in the long term starts today

Hebel delivers a diverse number of environmental benefits over particle board and concrete. Independent testing shows that overall, Hebel has a 30% lower environmental impact than concrete or brick veneer. Hebel panels use 60% less embodied energy and produces 55% less greenhouse emissions compared to concrete or brick veneer, making it a more sustainable, environmentally friendly choice of building material.



## ...for all the best reasons

With the attributes and benefits shown above this innovative and versatile masonry product provides confidence that Hebel is ideal for solid floors as detailed throughout the remainder of this Design and Installation Guide.

# 1.1 Design

## Typical Applications

Hebel PowerFloor systems detailed in this design and installation guide are joist floor solutions for residential, low rise multi-residential, commercial and industrial construction. The floor applications consist of a Hebel PowerFloor panel connected to a steel or timber joist system forming a platform floor.

Figures 1.1, 1.2, 1.3 show typical applications for Hebel PowerFloor. Contact CSR Technical Services for further details.

*Fig 1.1 Residential Suspended Ground Floors*



*Fig 1.2 Residential Suspended First Floors*



*Fig 1.3 Commercial Floors - schools, offices and community centres*



## 1.2 How to use this Design and Installation Guide

### Systems Index - Table 1.4

This allows the designer to quickly locate a system that combines the acoustic rating (STC/R<sub>w</sub>/R<sub>w</sub>+C<sub>tr</sub>), approximate floor thickness (excluding joist height), floor covering type and ceiling system requirement.

### System Components, System Properties & Design Considerations

These sections provide relevant background information to enable designers to plan and select appropriate Hebel PowerFloor systems.

### Hebel PowerFloor System Pages

These pages provide detailed performance information to assist in the selection of an appropriate Hebel PowerFloor system for the application under consideration.

### Architectural Specification

This material can be copied for inclusion onto working drawings or project specifications. This provides a pro-forma layout with fill in sections to quickly and easily create and customise project specifications.

### Installation Diagrams and Fixing Instructions

General design and installation information is provided for the various systems available. For more detailed information contact your CSR Hebel representative. For further information on different joist types and their applications, please contact the joist manufacturer.

## Selecting a system

**STEP 1.** Scan the 'System Index' for systems with the appropriate floor covering for the intended application.

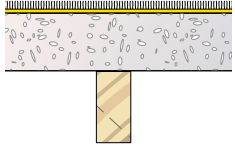
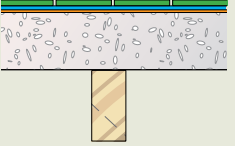
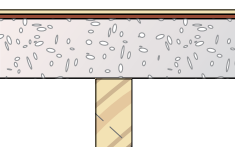
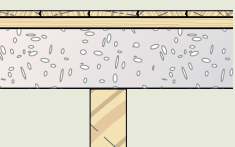
**STEP 2.** Determine the acoustic and thermal performance requirements by contacting the appropriate project engineer.

**STEP 3.** Turn to the selected system page and select ceiling system that provides appropriate performance (FRR/STC/IIC/R<sub>w</sub>/R<sub>w</sub>+C<sub>tr</sub>/L<sub>nw</sub>+C<sub>1</sub>/R-Value).

**STEP 4.** Determine the structural requirements of the floor (live load & dead load) by contacting the appropriate engineer or architect.

**STEP 5.** Determine joist type, size and spacing from the joist span tables in section 2.3 of this guide or from the project engineer as appropriate.

**Table 1.4 System index for CSR Hebel PowerFloor Systems**

Hebel PowerFloor System Description	Floor Covering Type	Applications & Benefits	System No.	System Details Page No.
	<ul style="list-style-type: none"> <li>• Carpet</li> <li>• Medium duty underlay</li> </ul>	<ul style="list-style-type: none"> <li>• Carpeted floor with a high level thermal performance.</li> </ul>	Hebel 1474 Hebel 1475 Hebel 1476	22
	<ul style="list-style-type: none"> <li>• 8mm Ceramic tiles</li> <li>• Flexible adhesive</li> <li>• Waterproof membrane (not required in dry areas)</li> </ul>	<ul style="list-style-type: none"> <li>• Rigid floor system, with good thermal performance. Suitable for wet or dry areas.</li> </ul>	Hebel 1478 Hebel 1479 Hebel 1481	25
	<ul style="list-style-type: none"> <li>• Vinyl sheet floor covering</li> <li>• Masonite underlay</li> </ul>	<ul style="list-style-type: none"> <li>• Inexpensive floor with a hard surface and high level of thermal performance.</li> </ul>	Hebel 1486 Hebel 1487 Hebel 1491	23
	<ul style="list-style-type: none"> <li>• 19mm T&amp;G hardwood flooring</li> <li>• 70 x 35mm timber battens</li> </ul>	<ul style="list-style-type: none"> <li>• Attractive solid timber finish with a high level of thermal performance.</li> </ul>	Hebel 1494 Hebel 1495 Hebel 1501	24

*Note: Resilient mounts will help reduce footfall noise when using hard surface coverings such as tiles.*

# 1.3 System Components

## These components are compatible with timber and steel joists.

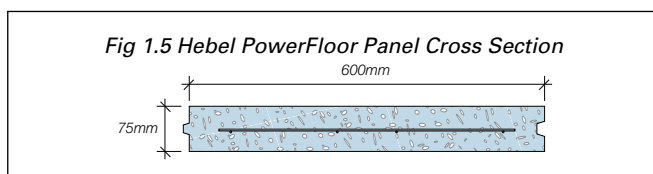
- Hebel PowerFloor Panel
- Floor Covering
- Proprietary Ceiling System
- Hebel Adhesive
- Fuller® Max Bond™
- Fasteners & Fixings
- Caulking

CSR Building Products Limited, guarantees only the products that are manufactured by CSR Hebel, not the components, products or services supplied by others.

## Hebel PowerFloor Panel

The Hebel PowerFloor panel is available in a stock length of 1800mm x 600mm width or 2400mm x 600mm width, with a mass of up to 56kg/panel. Where necessary, panels can be cut on-site using a circular saw with diamond tipped cutting blade. The minimum recommended width of a cut panel is 270mm wide and 600mm long.

The panels are screw fixed and bonded to all floor joists including at panel butt joints. Panel butt joints must occur over structural framing support. For further information on fixing Hebel PowerFloor panels, please refer to relevant construction details outlined in this guide.



## Floor Coverings

A range of floor coverings can be installed over the Hebel PowerFloor panels, such as, direct stick tiles, carpet and underlay, topping slab and tiles, timber (floating or on battens) and vinyl over masonite.

## Timber & Steel Support Systems

Timber or steel floor framing can be used to support the Hebel PowerFloor panels. The allowable spacing of the joists is 300mm, 450mm or 600mm (maximum). The joists, bearers and other supports shall be sized in accordance with the project engineer recommendations. For selection of solid timber joists refer also to section 2.3. Where steel joist framing are used it must be ensured that the PowerFloor panels are provided with uniform and complete bearing onto each steel joist.

*Note: When determining floor joist or supporting framing design, the designer should allow at least 42kg/m<sup>2</sup> for the self-weight of the Hebel PowerFloor panel under in-service conditions (panel weight at 10% moisture content). Consideration may also need to be given to the self-weight during construction which is likely to be approx. 51kg/m<sup>2</sup> (panel weight at 30% moisture content). A minimum joist flange width of 45mm is required.*

## Proprietary Ceiling Systems

The underside of Hebel PowerFloor can be lined with proprietary ceiling systems. These ceiling systems consist of combinations of components, such as furring channel, resilient mounts, clips, suspended steel framing, insulation, and plasterboard.

The most common combinations are detailed in the table below with relevant FRR'S achieved.



Hebel flooring	GIB System reference	Ceiling lining	Joists	FRR
Hebel Powerfloor	GBFC 30	1 x 13mm GIB Fyreline	Timber joist	30/30/30
	GBCJ 30	1 x 13mm GIB Fyreline	Composite joist	
	GBSJ 30	1 x 13mm GIB Fyreline	Steel joist	
	GBSC 30	1 x 13mm GIB Fyreline	Suspended grid	
	GBUC 30	1 x 16mm GIB Fyreline	Timber or steel joist	
	GBDFA 30a	2 x 13mm standard plasterboard	Timber joist	
	GBDFA 30d	1 x 13mm GIB Braceline/ Noiseline	Timber joist	45/45/45
	GBFC 45	1 x 13mm GIB Fyreline	Timber joist	
	GBCJ 45	1 x 13mm GIB Fyreline	Composite joist	
	GBSJA 45	2 x 13mm GIB Fyreline	Steel joist	
	GBSCA 45	2 x 13mm GIB Fyreline	Suspended grid	60/60/60
	GBFC 60	1 x 16mm GIB Fyreline	Timber joist	
	GBCJ 60	1 x 16mm GIB Fyreline	Composite joist	
	GBSJ 60	1 x 16mm GIB Fyreline	Steel joist	
	GBSC 60a	2 x 13mm GIB Fyreline	Suspended grid	
	GBSC 60b	1 x 16mm GIB Fyreline	Suspended grid	
	GBUC 60	2 x 13mm GIB Fyreline	Timber or steel joist	
	GBDFA 60b	2 x 13mm GIB Fyreline	Timber joist	
	GBDFA 60d	2 x 13mm GIB Fyreline	Timber joist	
	GBDFA 60e	2 x 13mm GIB Fyreline	Timber joist	
	GBSJA 60	1 x 16mm and 1 x 13mm GIB Fyreline	Steel joist	90/90/90
	GBSCA 60a	1 x 13mm and 1 x 16mm GIB Fyreline	Suspended grid	
	GBFC 90	2 x 16mm GIB Fyreline	Timber joist	
	GBSC 90	1 x 13mm and 1 x 16mm GIB Fyreline	Steel joist	120/120/120
GBUC 90	2 x 19mm GIB Fyreline	Timber or steel frame		
GBFC 120	2 x 19mm GIB Fyreline	Timber or steel frame		
GBUC 120	2 x 19mm GIB Fyreline	Timber or steel frame		

## Hebel Adhesive

Hebel Adhesive (supplied in 20kg bags) is used for gluing the panels together at all joints. Typically, panel joints are 2-3mm thick. Sufficient pressure is to be applied to the joint to ensure full coverage of adhesive in the joint. Adhesive is to be mixed to the proportions as stated on the bag.

## Construction Adhesive

A 5mm (minimum) bead of Fuller Max Bond construction adhesive is applied to the top of the joists. Where panel ends butt together over a common joist, two beads of adhesive shall be applied. Ensure the surface is free of coatings and loose material that may inhibit bond.

## Fasteners

The correct sized fasteners for the construction of the floor systems must always be used. Install screws as shown in the Hebel PowerFloor Panel Fixing Details section of this guide.

### Screws for fixing Hebel PowerFloor panels to Timber

**Joists:** 14-10 x 100mm MP Bugle Head Batten Screws or equivalent. 14-10 x 125mm Hex Head Screws or equivalent for skew fixing where required.

### Screws for fixing Hebel PowerFloor panels to Steel

**Joists:** 14-10 x 95mm Hex Head Self-tapping Screws or equivalent (no seal required). 14-10 x 135mm Hex Head Self-tapping Screws or equivalent (no seal required) for skew fixing where required. These fasteners are suitable for metal thickness <3mm. Refer to screw manufacturer's guidelines.

## Caulking

Hebel PowerFloor requires that all gaps at openings, penetrations and control joints be caulked to provide an airtight floor system that maintains acoustic, thermal, vermin and fire resistance performance. All gaps must be carefully and completely filled with an appropriate flexible polyurethane sealant, installed in accordance with the sealant manufacturer's specifications.

## Hebel Patch

Minor chips or damage to panels are to be repaired using Hebel Patch. Hebel Patch is available in 10kg bags.

## Hebel anti-corrosion protection paint

Reinforcement exposed when panels are cut shall be coated with a liberal application of Hebel anti-corrosion protection paint.

# 1.4 Design Considerations

## Acoustics

Placement of insulation in the ceiling cavity can enhance the sound insulation performance of a floor/ceiling system.

A carpet/underlay floor covering incorporated with Hebel PowerFloor will provide the best impact sound resistance. For hard surface floor coverings, we suggest using a floating floor and/or an independent ceiling system, incorporating resilient mounts or resilient furring channels.

For ceilings that incorporate resilient mounts or resilient furring channels, flanking sound paths through adjacent walls are common, especially in timber framed buildings. To maintain STC/R<sub>w</sub>/R<sub>w</sub>+C<sub>tr</sub> and IIC and L<sub>nw</sub>+C<sub>1</sub> ratings, the wall linings may also need to be resiliently mounted. For multi-tenancy buildings, providing a control joint at the party wall junctions will break a flanking path and maintain acoustic amenity.

## Alternative Framing

Alternative support framing systems including steel, and composite steel/timber joists, laminated timber joists, and trussed plywood web joists may be used without reducing the system FRR rating for a fire source 'from above'. The design of joists shall allow for temperature effects. Alternative support framing systems may affect acoustic performance, and advice from an acoustic consultant is recommended.

## Penetration Restrictions

Penetrations may be required to accommodate services, such as waste pipe-work, water pipe-work, and air conditioning ductwork, etc. Hebel PowerFloor can accommodate an 80mm maximum circular penetration without a reduction in structural performance. Multiple penetrations in the same panel are to be in a straight line, parallel to the long edge of the panel.

For large or clustered multiple penetrations, additional joists or bridging should be included for support of the panel in this area. Refer to the 'Penetration & Notching Details' section of this guide. All penetrations are a potential source for water ingress or air leaks, and should be sealed with an appropriate flexible fire rated sealant or proprietary collar.

## Control Joint Layout

Control joints are a necessary part of Hebel PowerFloor. Control joints provide a region in which to relieve stress due to movement of the structural system, and to control the location where movement can occur without a detrimental effect on the floor finish.

Recommended locations for control joints are:

- Typically at a max. spacing of 6000mm.
- Over lines of support for the joists. Refer to Fig 3.10.
- Located at changes in joist orientation.

## Wet Area Floor Construction

All wet areas require a waterproof membrane layer over the Hebel PowerFloor panel. Waterproofing membranes shall be nominated by the designer or specifier, and installed in accordance with manufacturer's recommendations.

## Serviceability Behaviour

The deflection limits of the floor are governed by the adopted joist size. As a guide, the following typical deflection limits provide acceptable behaviour and dynamic response:

- Dead Load (DL): span/300 or 12.5mm max.
- Live Load (LL): span/360 or 9mm max.
- DL & LL: span/400.
- Dynamic Response: 2mm max. under a 1kN point load.

*Note: The designer should select appropriate deflection limits to suit individual projects.*

## Concentrated Loads

For concentrated loadings, such as a loadbearing wall or point loads, the designer should ensure additional joists or blocking are provided beneath the wall or bearing plate. This will reduce the localised bearing stress. Bearing stress in the AAC shall be limited to 1.0MPa.

## Bracing

For bracing walls parallel to joists, a joist shall be positioned beneath the wall. For bracing walls perpendicular to joists, blocking shall be positioned beneath the wall. Blocking shall have a minimum width of 45mm. Bearing stress in the AAC shall be limited to 1.0MPa. Hebel PowerFloor is not considered to provide a horizontal diaphragm bracing capacity. Should such capacity be required a separate bracing system will need to be used - refer to the project engineer.

## Panel Support

All Hebel PowerFloor panels are to start and finish over a joist or support framing. Where panel joints bear onto a common joist the panel ends must not be cut i.e use a factory produced panel end.

# 1.5 Architectural Specification

This specification should be adopted as a guide only, and shall be superseded by the contract specifications of the project.

*\* Insert or select appropriate specifications.*

## Scope

The contractor shall furnish all material and equipment required to satisfactorily complete the installation and jointing of Hebel PowerFloor where indicated in the contract specification.

## Materials

All AAC material shall be a Hebel PowerFloor panel as manufactured by CSR Hebel.

All accompanying fixings shall be those supplied by CSR Hebel or approved by the project engineer.

Steel frame components shall be those manufactured by Rondo Building Services Pty Ltd (or products of equivalent or better performance).

Construction adhesive shall be Fuller Max Bond as manufactured and supplied by Fuller (or products of equivalent or better performance).

All sealants shall be a polyurethane type with required fire and acoustic ratings, (or products of equivalent or better performance).

All infill materials shall be products manufactured and supplied by CSR Bradford® (or products of equivalent or better performance).

## Levels of Finish - Floor Covering

Prior to installation of the floor covering, the contractor shall ensure the installed panels are within the tolerances of the project specifications. The contractor shall ensure that all control joints are installed as per project specifications, panel joints are completely filled with Hebel Adhesive, minor chipping damage of the panels shall be patched with Hebel Mortar, and all sealants are installed as per manufacturer's specifications.

Floor coverings shall be installed as per manufacturer's specifications, unless specified otherwise in the contract documentation.

## Plasterboard fixing

All layers shall be fixed to the framing (ie., timber or steel floor joists and/or steel furring channels) as specified for the relevant ceiling system.

## Caulking

Where caulking is indicated in Powerfloor systems fire rated polyurethane sealant or fire rated backing rod with acoustic rated polyurethane sealant shall be used, and installed in accordance with the manufacturer's recommendations.

Where caulking is indicated in wet areas, a polyurethane sealant must be used when caulking \*non-fire rated/fire rated wet areas, as indicated, and installed in accordance with the manufacturer's recommendations.

## Important

Any variation or substitution of materials or assembly requirements, or compromise in assembly may result in failure under critical conditions.

# 2.1 System Properties

## Hebel PowerFloor

Hebel autoclaved aerated concrete (AAC) PowerFloor panels generally follow the design principles outlined in Australian Standard AS5146 - Reinforced Autoclave Aerated Concrete for strength and serviceability design, with the exception of cover requirements for durability where corrosion protection coatings have been used on the steel reinforcement. When used as a flooring material, Hebel PowerFloor meets the requirements of NZBC B1 Structure and meets the 50 year durability performance requirement of NZBC B2 Durability.

## Structural Performance

Hebel PowerFloor systems can support a maximum uniformly distributed load of 5kPa, or concentrated (point) load 1.8kN over a load area of 350mm<sup>2</sup> (with joist at 450mm or 600mm centres only) & 3.9kN over a load area of 10,000mm<sup>2</sup> (with joists at 300mm centres). For loads outside this range, please contact CSR Hebel.

The designer should specify the magnitude of the gaps between the Hebel PowerFloor panel and structure. This gap will allow movement to release any confining stresses due to movement of the supporting structure.

## Diaphragm Capacity

Hebel PowerFloor 75mm AAC floor panel system is able to achieve diaphragm action to resist in plane shear forces when constructed in accordance with this Design & Installation Guide.

The maximum ultimate in-plane shear force that can be applied to the floor structure = 4 kN/m. The minimum floor panel size should be 3.6m x 1.8m. Panels assumed to be continuous with Hebel adhesive between panels. Determination of the load value(s) remains the responsibility of the project design engineer.

## Durability

Where Hebel PowerFloor is installed in a multi-residential/commercial application, the PowerFloor panels must be suitably protected against trafficability during construction to maintain the long term durability and integrity of the panels. It is the responsibility of the builder to provide and maintain such protective coverings to the PowerFloor panels until such time that the finished floor coverings are installed.

For application of PowerFloor in commercial projects Hebel Technical Services must be contacted for advising on durability and protection of the PowerFloor panels during construction.

## Fire Resistance Rating (FRR)

New Zealand building regulations express the fire performance of building elements with the rating system called the Fire Resistance Rating according to the Life Rating, Property Rating and Risk Group.

Risk Group (RG) is the classification of a building or Firecells within a building according to its intended use and activities of the occupants.

Firecells are any space including a group of contiguous spaces on the same or different levels within a building, which are enclosed by any combination of fire separating walls, roofs and/or floors.

Life Rating (LR) is to be applied to elements of construction that allow movement of people from their location in a building to a safe place.

Property Rating (PR) is to be applied to elements of construction that allows for protection of other (i.e adjacent) property.

Fire Resistance Rating (FRR) is used to describe the minimum fire resistance required of primary and secondary building elements as determined in the standard test for fire resistance (i.e Fire Test), or in accordance with a specific calculation method verified by experimental data from standard fire resistance tests (i.e Fire Assessment).

The FRR rating consists of three performance criteria, structural adequacy/integrity/insulation.

The fire performance of Hebel PowerFloor system is determined by the ceiling lining. Page 9 of this guide lists the FRR of Hebel PowerFloor system with variety of ceiling configurations.

## Acoustic Considerations

### Sound Ratings

Floor systems, consisting of the Hebel PowerFloor and other products, have been laboratory tested to establish their sound insulation characteristics. A laboratory test involves the installation of a system between two massive concrete rooms, which are normally well isolated from one another, so that only direct transmission is via the system.

A steady sound level of various frequencies is generated on one side and measurements taken on both sides. These measurements are made in one/ third octave bands from 100Hz to 5000Hz. For each specified frequency, the sound transmission loss is calculated. To assist in communication the performance is conveniently expressed as a single number called the 'Weighted Sound Reduction Index' ( $R_w$ ).

### Weighted Sound Reduction Index ( $R_w$ )

Currently, New Zealand building regulations express the acoustic performance of a building element (or system) using the Sound Transmission Class (STC) rating. The International Standard Organisation acoustic rating system called the Weighted Sound Reduction Index ( $R_w$ ) is essentially identical.

A correction figure of  $C_{tr}$  is sometimes added to the  $R_w$  value to better quantify the low frequency performance of the building system. This is not used with STC ratings.

### $C_{tr}$ Adaptation Term

The normal rating of  $R_w$  more closely defines the acoustic performance for speech frequencies. Where low frequency sound insulation performance is important, as may be the case with traffic noise or music and DVD systems, then a correction factor is applied to the airborne sound rating ( $R_w$ ) to differentiate the systems with good sound insulation to these frequencies. The factor is  $C_{tr}$  and it is a negative value. A system with good low frequency performance will have a value of say -4; a system with poor performance will have a value of say -12.

### Impact Isolation Class (IIC)

The Impact Isolation Class (IIC) quantifies the transmission of impact sound through a floor/ceiling system. The test involves impacting the floor assembly with a standard tapping machine and measuring the sound level below in the same manner as described for the airborne sound insulation. Higher numbers indicate less sound is being transmitted. IIC is an American system and is to be replaced in New Zealand by  $L_{n,w}$ , which is the ISO equivalent.

### $L_{n,w}$

$L_{n,w}$  is the ISO equivalent of the American IIC system, but with the ISO method, lower numbers mean less sound (better performance). Typically,  $L_{n,w} = 110 - IIC$ .

### C1 Adaptation Term

The rating by  $L_{n,w}$  appears to work well where carpets or floating floors are employed on concrete or timber framed floors. With hard floor finishes, particularly with timber joist floors, the low frequency performance may require further consideration by your acoustic consultant.

### Sound Transmission Estimates

Computer models are used to determine sound transmission estimates for specific configurations, known as 'Acoustic Assessments'. The computer model predicts the  $R_w$  performance expected from the laboratory test on the system, with a 96% confidence limit of  $\pm 2.5$  db.

### Performance - Laboratory vs Field.

When selecting the appropriate Hebel PowerFloor system, the designer or specifier must be aware that the field performance will nearly always be lower than the laboratory  $R_w$  values. This is due to the field conditions, such as flanking paths, air leaks, floor frame construction type and stiffness, etc., which can be exacerbated by careless building design or construction. To avoid significant reductions in acoustic performance, published construction details must be followed completely. Independent specific advice and confirmation should be sought for projects where the acoustic performance is critical.

Typically, the field performance of a system will be within 5  $R_w$  or STC units (i.e 5dB) of the laboratory performance, and allowance should be made for this by the acoustic consultant during the selection of the floor system.

## Thermal Performance

Thermal performance is concerned with the energy retention or loss characteristics of a building system. One of the primary design objectives in planning a cost effective building is to provide a comfortable living/working environment for the building's inhabitants. Exploiting the inherent thermal qualities of Hebel AAC enables the designer to achieve this objective.

### R-Value Rating

The energy demand can be minimised by controlling the heat transfer, which is heat flowing from a hot region to a colder region, through a building system. The thermal resistance of a building system is expressed as the R-Value. The R-Value of the system is the sum of the R-Values of the individual components.

## Thermal Masses & Insulation Property

Several comparative studies have been conducted to investigate the benefits of incorporating Hebel AAC walls in place of conventional wall systems or thermal mass. A common trend was the lower heating and cooling energy consumption and smaller mechanical equipment required to maintain a comfortable living environment, especially with regards to regions of mainly cold weather.

The benefit of thermal mass is that it tends to buffer the effects of external temperature swings. Thermal mass coupled with the insulation quality of Hebel AAC, which impedes the flow of heat through the floor, gives an excellent barrier to a variable outside elements.

### Thermal Integrity

Poor thermal integrity, due to bad construction practices can also significantly affect the comfort performance, as poor sealing and gaps allow air to infiltrate as drafts. The inherent construction tolerances of Hebel PowerFloor provides a floor with a low infiltration rate and good thermal integrity.

## 2.2 Building Regulations

### Compliance with the New Zealand Building Code (NZBC)

In New Zealand, the building of houses and other buildings is controlled by the Building Act 2004. This applies to the construction of new buildings as well as the alteration of existing buildings. The Building Act 2004 requires that all building work comply with the New Zealand Building Code (NZBC), whether or not a building consent is required in respect of that building work.

Where a building consent is required, this will be issued by a Building Consent Authority (BCA) once they have established that compliance with NZBC will be achieved with respect to the building work.

This design guide presents tables, charts and information necessary to design the Hebel Powerfloor System that complies with the Performance Requirements of the NZBC. The designer must check the adequacy of the building solution for Performance Requirements outlined by the appropriate authority.

One means of establishing compliance with NZBC is to achieve certification under the CodeMark Product Certification scheme which is administered in New Zealand by the Ministry of Business Innovation and Employment (MBIE). CodeMark certificates have the same legal status as a compliance document and must be accepted by a BCA.

The Hebel Powerfloor System is compliant with the performance requirements of the New Zealand Building Code (NZBC) as evidenced by achieving CodeMark product certification.

The CodeMark certificate sets out which clauses of NZBC are being complied with along with any conditions or limitations that need to be applied. For the Hebel Powerfloor System, the following conditions and limitations apply:

- a) Only to be installed in accordance with Hebel® PowerFloor Low Rise Residential & Commercial Floor System – New Zealand Design and Installation Guide (HELIT014 SEP21).

- b) Will contribute to meeting the requirements of airborne and impact sound transmission.
- c) Will contribute to meeting the requirements of NZS 4214:2006.
- d) Energy Efficiency and Sound Insulation performance is dependent on the appurtenant ceiling system and/ or floor coverings type, Refer to certificate holder for exact values.

### Intertenancy Floors

Floors constructed between separate tenancies are required to achieve the minimum fire, acoustic and thermal performance in accordance with the following New Zealand Building Code (NZBC) clauses:

- Clauses C1-C6 (Protection from Fire),
- Clause G6 (Airborne and Impact Sound),
- Clause H1 (Energy Efficiency)

Where PowerFloor installation is continuous between tenancies on the same level there is no need for separation or a control at the tenancy wall junction (unless a control joint is required as determined by the control joint recommendations in Section 1.4 of this guide) in order to achieve compliance with NZBC.

Once the project requirements for Fire Resistance Rating (FRR), acoustic and thermal performance have been determined, the designer can select a specific Hebel System from the appropriate tables in section 3.2

## 2.3 Joist Span Tables

Tables 1.6 to 1.9 provide parameters to assist the designer in the selection of an appropriate solid timber joist type, spacing and maximum clear span for support of the 75mm Hebel PowerFloor panel with consideration to the floor finishes and relevant floor loading requirements.

Joists supporting AAC flooring systems may not be selected from the tables within NZS 3604 as those tables have not made allowance for the self-weight of an AAC flooring panel. For the Hebel PowerFloor system, solid timber joists may be selected from the tables provided in this section, subject to the conditions below. For all other joist types (e.g. steel or engineered wood products), or where the tables in this section are provided for the purpose of guidance only, the joists shall be specifically designed using certified proprietary software or by an appropriately qualified structural engineer.

Two types of tables are provided in this section. Each set provides for different dynamic response deflection criteria. Dynamic deflection is the deflection that is likely to occur under foot-fall for a given live load. The recommended limit on dynamic deflection for floors in AS/NZS 1170 is given as less than 2mm (when subject to a 1kN concentrated live load), however, some designers may feel that they require a more conservative deflection limit. For this reason we have provided alternative tables (tables 1.6 and 1.7) where the joist spans are limited to a maximum dynamic response deflection of 1.5mm. The tables in this section also provide for the use of either SG8 or SG10 timber under each dynamic deflection criteria.

Timber framing shall be treated to meet requirements of NZS 3602:2005 as modified by NZBC B2/AS1.

The tables in this guide have been engineered to meet the requirements of NZBC B1/VM1 and are provided for use under the following conditions:

- Static deflection limit: span/400

- All maximum span values have been calculated with consideration for standard floor finishes i.e. such as carpet, vinyl, 25mm timber strip flooring overlays or 8mm ceramic tiles laid on up to a 10mm thick plaster bedding compound base;
- Where the table provides for zero superimposed dead load (other than the floor finishes already allowed for as above) and where the live load does not exceed 2kPa, the maximum joist span values provided are applicable for use in structures within the scope limitations of NZS 3604 (to importance level 2 buildings). In the applications a minimum of 2 screw fixings are required per panel panel joist i.e. where panels are continuous over a joist and at panel butt ends over a common joist. The joist spans for these combinations are shaded orange in tables 1.6 to 1.9;
- For all other superimposed dead load and live load combinations, these tables are provided for guidance purposes only. Selection for these combinations shall be by specific design and must be verified by the use of certified proprietary software or by an appropriately qualified structural engineer. The joist spans for these combinations are shaded in grey in tables 1.6 to 1.9.

**Note: For applications where:**

- *The building is in earthquake zone 4 and,*
- *The super imposed dead load is greater than 0.75kPa and live load exceeds 2.0kPa and,*
- *The joist spacing is greater than 450mm,*

**3 screws per panel per joist are recommended, however, such fixings shall be by specific engineering design.**



**Table 1.6: Joist Span Table for SG8 Timber (Dry in service) – spans limited to 1.5mm dynamic deflection & up to 1.8kN concentrated load for joist spacing 600/450 mm OR up to 3.9kN concentrated load for joist spacing 300mm**

JOIST SPACING (mm)	SUPERIMPOSED DEAD LOAD (kPa)	LIVE LOAD (kPa)	JOIST SIZE and max. span (m)			
			140x45	190x45	240x45	290x45
600	0*	1.5	1.79	2.45	3.10	3.74
		2.0	1.79	2.45	3.10	3.74
		3.0	1.22	2.25	3.10	3.74
		5.0	0.75	1.38	2.21	3.00
	0.5	1.5	1.68	2.45	3.10	3.74
		2.0	1.68	2.45	3.10	3.74
		3.0	1.17	2.16	2.94	3.55
		5.0	0.73	1.35	2.15	2.89
	1.0	1.5	1.59	2.36	3.05	3.69
		2.0	1.59	2.36	2.98	3.59
		3.0	1.13	2.08	2.80	3.38
		5.0	0.71	1.31	2.10	2.80
450	0*	1.5	1.82	2.45	3.10	3.74
		2.0	1.82	2.45	3.10	3.74
		3.0	1.24	2.28	3.10	3.74
		5.0	0.75	1.39	2.22	3.25
	0.5	1.5	1.74	2.45	3.10	3.74
		2.0	1.74	2.45	3.10	3.74
		3.0	1.20	2.22	3.10	3.74
		5.0	0.74	1.37	2.18	3.18
	1.0	1.5	1.67	2.45	3.10	3.74
		2.0	1.67	2.45	3.10	3.74
		3.0	1.16	2.15	3.10	3.75
		5.0	0.73	1.34	2.14	3.12
300	0*	1.5	1.66	2.45	3.10	3.74
		2.0	1.66	2.45	3.10	3.74

**FOR GUIDANCE ONLY**

**Note:**

1. The joist spans in this table have been determined by limiting the dynamic response of the joist to 1.5mm when subject to a 1kN point load at the joist mid-span.
2. This superimposed dead load case, 0\*(kPa), includes for standard floor finishes such as carpet, vinyl, 25mm timber strip flooring overlays or 8mm ceramic tiles laid on up to a 10mm thick plaster bedding compound base.
3. The 0.5 (kPa) and 1.0 (kPa) superimposed dead load cases allow for heavier floor finishes over those described in note 2, or, for partition walls installed over the PowerFloor system. Determination of such loading must be made by an appropriately qualified structural engineer.

**Table 1.7: Joist Span Table for SG10 Timber (Dry in service) – Spans Limited by 1.5mm deflection & up to 1.8kN concentrated load for joist spacing 600/450 mm OR up to 3.9kN concentrated load for joist spacing 300mm**

JOIST SPACING (mm)	SUPERIMPOSED DEAD LOAD (kPa)	LIVE LOAD (kPa)	JOIST SIZE and max. span (m)			
			140x45	190x45	240x45	290x45
600	0*	1.5	1.94	2.64	3.34	4.03
		2.0	1.94	2.64	3.34	4.03
		3.0	1.75	2.64	3.34	4.03
		5.0	1.07	1.98	2.97	3.58
	0.5	1.5	1.97	2.64	3.34	4.03
		2.0	1.97	2.64	3.34	4.03
		3.0	1.68	2.58	3.25	3.92
		5.0	1.04	1.93	2.87	3.46
	1.0	1.5	1.82	2.56	3.30	3.98
		2.0	1.82	2.55	3.21	3.87
		3.0	1.61	2.42	3.05	3.68
		5.0	1.02	1.88	2.77	3.35
450	0*	1.5	1.94	2.64	3.34	4.03
		2.0	1.94	2.64	3.34	4.03
		3.0	1.77	2.64	3.85	4.03
		5.0	1.08	1.99	3.18	4.03
	0.5	1.5	1.94	2.64	3.34	4.03
		2.0	1.94	2.64	3.34	4.03
		3.0	1.72	2.64	3.34	4.03
		5.0	1.06	1.95	3.12	3.91
	1.0	1.5	1.94	2.64	3.34	4.03
		2.0	1.94	2.64	3.34	4.03
		3.0	1.67	2.58	3.35	4.04
		5.0	1.04	1.92	3.06	3.73
300	0*	1.5	1.94	2.64	3.34	4.03
		2.0	1.94	2.64	3.34	4.03

**FOR GUIDANCE ONLY**

- Note:**
- The joist spans in this table have been determined by limiting the dynamic response of the joist to 1.5mm when subject to a 1kN point load at the joist mid-span.
  - This superimposed dead load case, 0\*(kPa), includes for standard floor finishes such as carpet, vinyl, 25mm timber strip flooring overlays or 8mm ceramic tiles laid on up to a 10mm thick plaster bedding compound base.
  - The 0.5 (kPa) and 1.0 (kPa) superimposed dead load cases allow for heavier floor finishes over those described in note 2, or, for partition walls installed over the PowerFloor system. Determination of such loading must be made by an appropriately qualified structural engineer.

**Table 1.8: Joist Span Table for SG8 Timber (Dry in service) – Spans Limited by 2.0mm deflection & up to 1.8kN concentrated load for joist spacing 600/450 mm OR up to 3.9kN concentrated load for joist spacing 300mm**

JOIST SPACING (mm)	SUPERIMPOSED DEAD LOAD (kPa)	LIVE LOAD (kPa)	JOIST SIZE and max. span (m)			
			140x45	190x45	240x45	290x45
600	0*	1.5	1.79	2.70	3.41	4.12
		2.0	1.79	2.70	3.41	4.12
		3.0	1.22	2.25	3.10	3.74
		5.0	0.75	1.38	2.21	3.00
	0.5	1.5	1.68	2.57	3.32	4.00
		2.0	1.68	2.55	3.21	3.87
		3.0	1.17	2.16	2.94	3.55
		5.0	0.73	1.35	2.15	2.89
	1.0	1.5	1.59	2.36	3.05	3.69
		2.0	1.59	2.36	2.98	3.59
		3.0	1.13	2.08	2.80	3.38
		5.0	0.71	1.31	2.10	2.80
450	0*	1.5	1.82	2.70	3.41	4.12
		2.0	1.82	2.70	3.41	4.12
		3.0	1.24	2.28	3.41	4.12
		5.0	0.75	1.39	2.22	3.25
	0.5	1.5	1.74	2.70	3.41	4.12
		2.0	1.74	2.70	3.41	4.12
		3.0	1.20	2.22	3.31	3.99
		5.0	0.74	1.37	2.18	3.18
	1.0	1.5	1.67	2.52	3.27	4.02
		2.0	1.67	2.52	3.27	3.93
		3.0	1.16	2.15	3.10	3.75
		5.0	0.73	1.34	2.14	3.12
300	0*	1.5	1.57	2.70	3.41	4.12
		2.0	1.57	2.70	3.41	4.12

**FOR GUIDANCE ONLY**

**Note:**

1. The joist spans in this table have been determined by limiting the dynamic response of the joist to 2.0mm when subject to a 1kN point load at the joist mid-span.
2. This superimposed dead load case, 0\*(kPa), includes for standard floor finishes such as carpet, vinyl, 25mm timber strip flooring overlays or 8mm ceramic tiles laid on up to a 10mm thick plaster bedding compound base.
3. The 0.5 (kPa) and 1.0 (kPa) superimposed dead load cases allow for heavier floor finishes over those described in note 2, or, for partition walls installed over the PowerFloor system. Determination of such loading must be made by an appropriately qualified structural engineer.

**Table 1.9: Joist Span Table for SG10 Timber (Dry in service) – Spans Limited by 2.0mm deflection & up to 1.8kN concentrated load for joist spacing 600/450 mm OR up to 3.9kN concentrated load for joist spacing 300mm**

JOIST SPACING (mm)	SUPERIMPOSED DEAD LOAD (kPa)	LIVE LOAD (kPa)	JOIST SIZE and max. span (m)			
			140x45	190x45	240x45	290x45
600	0*	1.5	2.14	2.91	3.67	4.44
		2.0	2.14	2.91	3.67	4.44
		3.0	1.75	2.79	3.52	4.24
		5.0	1.07	1.98	2.97	3.58
	0.5	1.5	1.97	2.80	3.58	4.31
		2.0	1.97	2.74	3.46	4.16
		3.0	1.68	2.58	3.25	3.92
		5.0	1.04	1.93	2.87	3.46
	1.0	1.5	1.82	2.56	3.30	3.98
		2.0	1.82	2.55	3.21	3.87
		3.0	1.61	2.42	3.05	3.68
		5.0	1.02	1.88	2.77	3.35
450	0*	1.5	2.14	2.91	3.67	4.44
		2.0	2.14	2.91	3.67	4.44
		3.0	1.77	2.91	3.67	4.44
		5.0	1.08	1.99	3.18	4.13
	0.5	1.5	2.08	2.91	3.67	4.44
		2.0	2.08	2.91	3.67	4.44
		3.0	1.72	2.76	3.57	4.29
		5.0	1.06	1.95	3.12	3.91
	1.0	1.5	1.94	2.75	3.56	4.35
		2.0	1.94	2.75	3.52	4.24
		3.0	1.67	2.58	3.35	4.04
		5.0	1.04	1.92	3.06	3.73
300	0*	1.5	2.14	2.91	3.67	4.44
		2.0	2.14	2.91	3.67	4.44

[ ] FOR GUIDANCE ONLY

**Note:**

1. The joist spans in this table have been determined by limiting the dynamic response of the joist to 2.0mm when subject to a 1kN point load at the joist mid-span.
2. This superimposed dead load case, 0\*(kPa), includes for standard floor finishes such as carpet, vinyl, 25mm timber strip flooring overlays or 8mm ceramic tiles laid on up to a 10mm thick plaster bedding compound base.
3. The 0.5 (kPa) and 1.0 (kPa) superimposed dead load cases allow for heavier floor finishes over those described in note 2, or, for partition walls installed over the PowerFloor system. Determination of such loading must be made by an appropriately qualified structural engineer.

# 3.1 Hebel PowerFloor Installation Sequence



## 1. Preparation of Framing for Hebel PowerFloor Panel Installation

- Check floor framing is complete and within level tolerances.
- Provide set-out chalk lines, as required.
- Provide temporary installation platform where necessary.
- Ensure floor framing has adequate strength to support Hebel PowerFloor bundles.
- Position Hebel PowerFloor bundles on the floor framing.



## 2. Hebel PowerFloor Panel Installation

- Panels are to be installed in a stretcher bond pattern, with a minimum overlap of 1 joist space and not less than 450mm.
- Use lifting handles or trolley to move the panels to installation area.
- Apply a 5mm min. bead of Fuller Max Bond construction adhesive (or equivalent) to top of joists in accordance with manufacturer's instructions, and apply Hebel Adhesive to appropriate panel edges.
- Panels must be installed with minimal horizontal sliding on the joists to ensure a good bond. Force the tongue and groove joint closed as the panel is rolled and lowered onto the joists. Ensure all joints are tight and that adhesive makes full contact along all joints.
- Screw fix panel to the joists as required.
- Repeat process, removing excess Hebel Adhesive.



## 3. Penetration Detailing

- Install blocking to support Hebel PowerFloor panel at major openings.



## 4. Floor Finishes

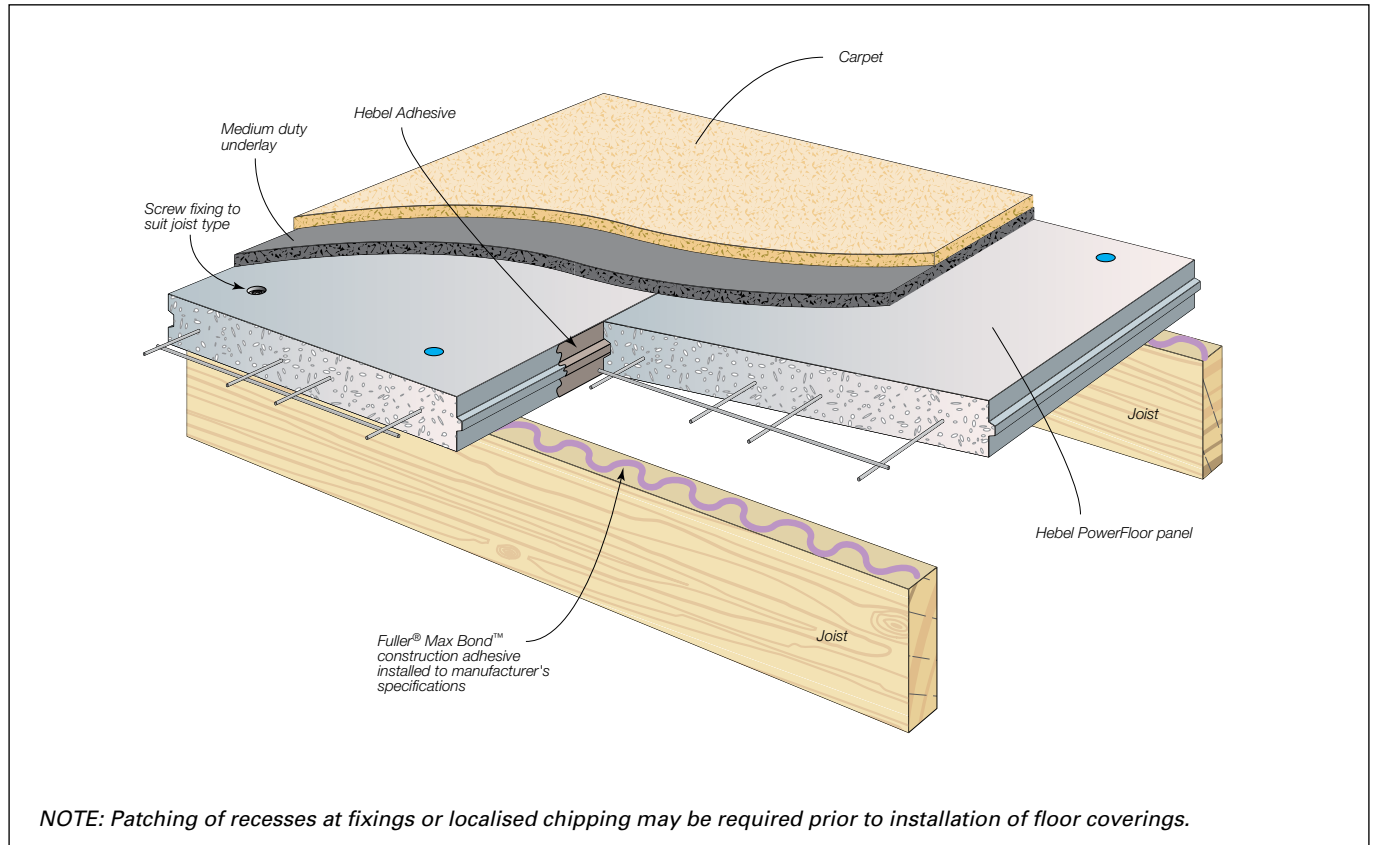
- Sweep the floor surface to remove debris and loose particles.
- Fill joints and screw holes with Hebel Adhesive, as required.
- Ensure perimeter is not chipped.
- Install floor covering for Hebel PowerFloor system in accordance with manufacturer's specifications.

*Note: Ensure panel moisture content is within limits outlined by the floor covering manufacturer.*

# 3.2 Construction Details

## Hebel PowerFloor System Carpet

Recommended for: Rigid, lightweight floor system with high impact sound insulation.



## Carpet Floor Coverings

System Number	System Description	Fire*	Acoustic****				Thermal***
		FRR	R <sub>w</sub> /STC	R <sub>w</sub> +C <sub>tr</sub>	IIC	L <sub>nw</sub> +C <sub>1</sub>	R-value
Hebel 1474	1 x 13mm GIB Fyreline	30/30/30	<b>56</b>	49	<b>71</b>	36	2.91
Hebel 1475	2 x 13mm GIB Fyreline	60/60/60	<b>58</b>	52	<b>73</b>	35	2.99
Hebel 1476	2 x 16mm GIB Fyreline	90/90/90	<b>59</b>	53	<b>73</b>	35	3.02

**Note**

\* Fire exposure is from underside.

\*\* Suitable underfloor insulation may be installed to achieve floor R-value of R1.3 as required by NZBC Clause H1 (Energy Efficiency).

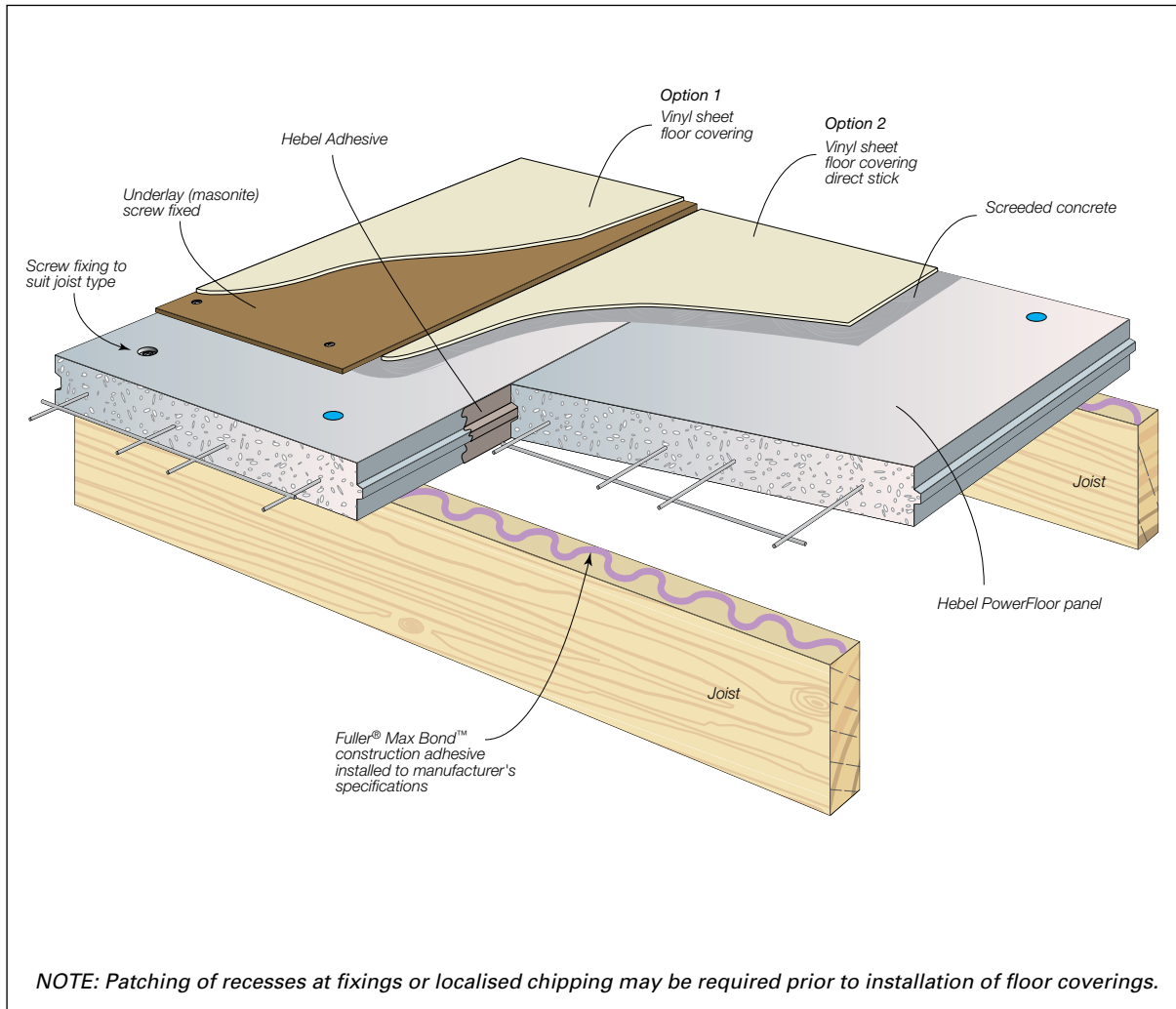
\*\*\* Thermal R-values in table include the addition of floor covering.

\*\*\*\* The acoustic performance is based on systems using min. 90mm ceiling batts R1.8, Resilient mounts, 28mm Rondo Furring Channels: cc 600mm and joist size of 190mm.

**IMPORTANT:** The NZ Code sound insulation requirements states a separating floor between occupancies to achieve a STC ≥ 55 and IIC ≥ 55. Bold figures equal NZ compliance.

## Hebel PowerFloor System Vinyl Sheet with Masonite

Recommended for: Rigid, lightweight floor system with thermal insulation and vinyl floor covering.



## Vinyl Floor Coverings

System Number	System Description	Fire*	Acoustic****				Thermal***
		FRR	R <sub>w</sub> /STC	R <sub>w</sub> +C <sub>tr</sub>	IIC	L <sub>nw</sub> +C <sub>1</sub>	R-value
Hebel 1486	1 x 13mm GIB Fyreline	30/30/30	57	49	47	63	2.63
Hebel 1487	2 x 13mm GIB Fyreline	60/60/60	59	52	51	59	2.71
Hebel 1491	2 x 16mm GIB Fyreline	90/90/90	60	53	52	58	2.74

### Note

\* Fire exposure is from underside.

\*\* Suitable underfloor insulation may be installed to achieve floor R-value of R1.3 as required by NZBC Clause H1 (Energy Efficiency).

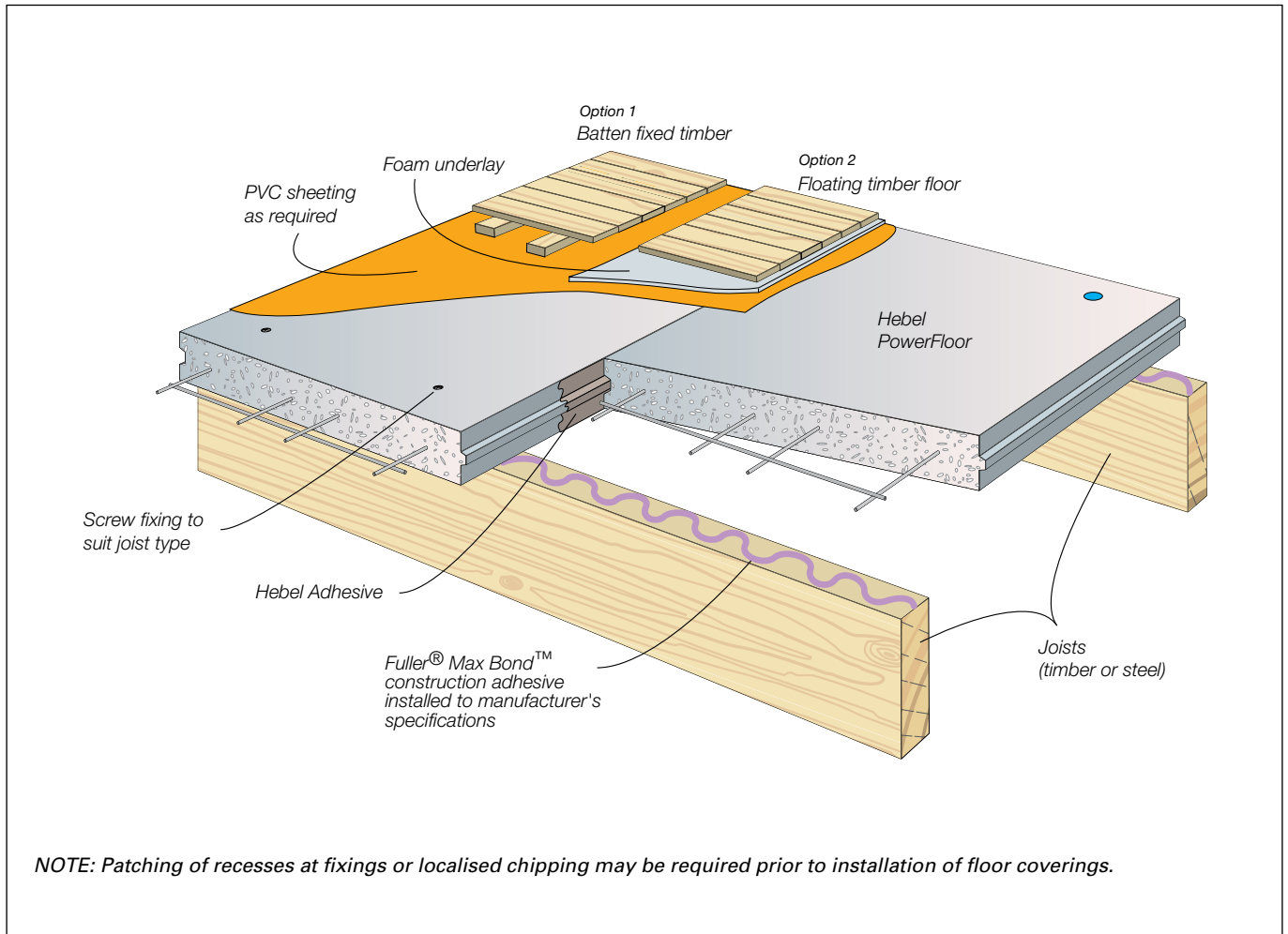
\*\*\* Thermal R-values in table include the addition of floor covering.

\*\*\*\* The acoustic performance is based on systems min. 90mm ceiling batts R1.8, Resilient mounts, 28mm Rondo Furring Channels: cc 600mm and joist size of 190mm.

**IMPORTANT:** The NZ Code sound insulation requirements states a separating floor between occupancies to achieve a STC ≥ 55 and IIC ≥ 55.

## Hebel PowerFloor System Timber Floors

Recommended for: Rigid, lightweight floor system with excellent thermal insulation and decorative timber flooring.



## Timber Floor Coverings (Floating Floor)

System Number	System Description	Fire*	Acoustic****				Thermal***
		FRR	R <sub>w</sub> /STC	R <sub>w</sub> +C <sub>tr</sub>	IIC	L <sub>nw</sub> +C <sub>1</sub>	R-value
Hebel 1494	1 x 13mm GIB Fyreline	30/30/30	57	49	48	62	2.78
Hebel 1495	2 x 13mm GIB Fyreline	60/60/60	59	52	52	58	2.86
Hebel 1501	2 x 16mm GIB Fyreline	90/90/90	60	53	53	57	2.89

### Note

\* Fire exposure is from underside.

\*\* Suitable underfloor insulation may be installed to achieve floor R-value of R1.3 as required by NZBC Clause H1 (Energy Efficiency).

\*\*\* Thermal R-values in table include the addition of floor covering.

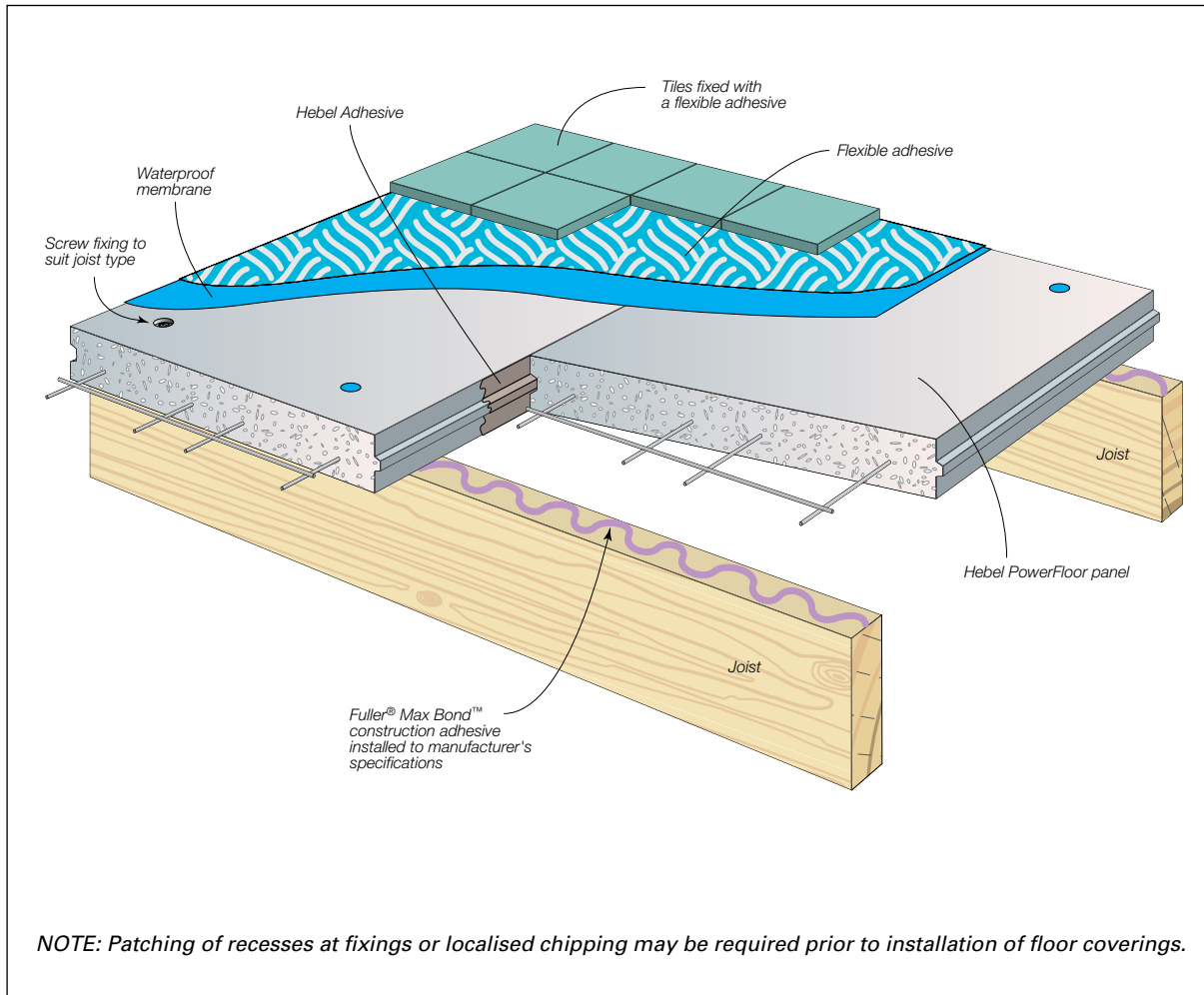
\*\*\*\* The acoustic performance is based on systems using 19mm timber floor, 3mm foam underlay, min. 90mm ceiling batts R1.8, Resilient mounts, 28mm Rondo Furring Channels: cc 600mm and joist size of 190mm.

**IMPORTANT:** The NZ Code sound insulation requirements states a separating floor between occupancies to achieve a STC ≥ 55 and IIC ≥ 55.



## Hebel PowerFloor System 8mm Ceramic Tiles

Recommended for: Rigid, lightweight floor system for wet areas while maintaining a high level of thermal insulation.



## 8mm Ceramic Tiles On Flexible Adhesive

System Number	System Description	Fire*	Acoustic****				Thermal***
		FRR	R <sub>w</sub> /STC	R <sub>w</sub> +C <sub>tr</sub>	IIC	L <sub>nw</sub> +C <sub>1</sub>	R-value
Hebel 1478	1 x 13mm GIB Fyreline	30/30/30	58	50	51	58	2.64
Hebel 1479	2 x 13mm GIB Fyreline	60/60/60	<b>60</b>	53	<b>55</b>	54	2.72
Hebel 1481	2 x 16mm GIB Fyreline	90/90/90	<b>61</b>	54	<b>56</b>	53	2.75

**Note**

\* Fire exposure is from underside.

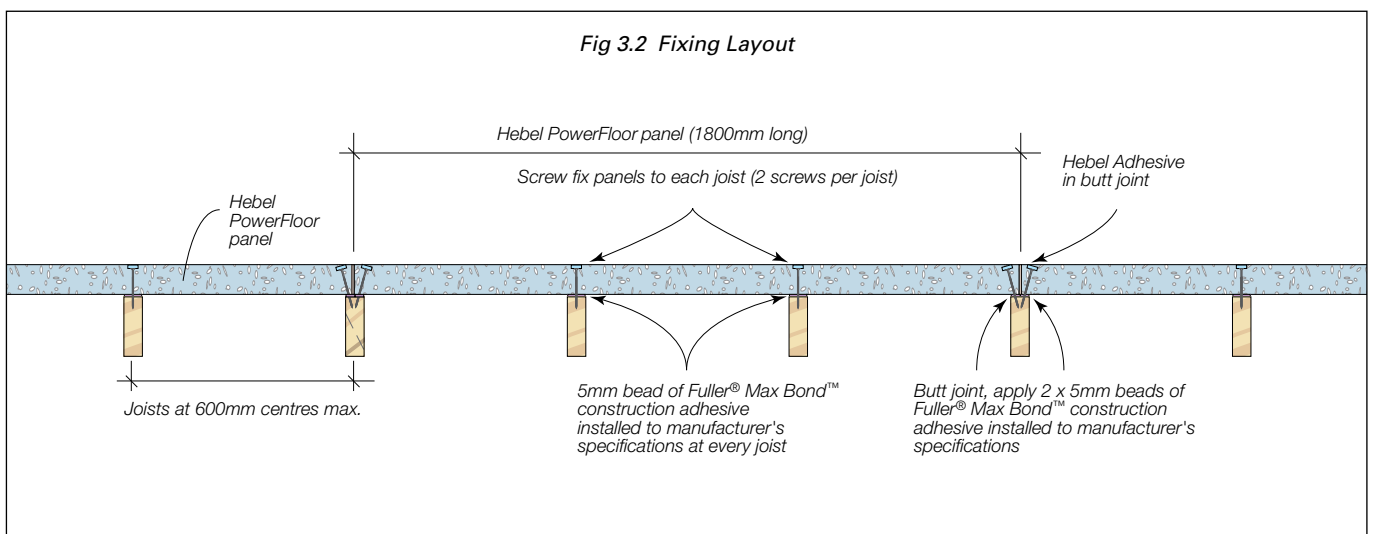
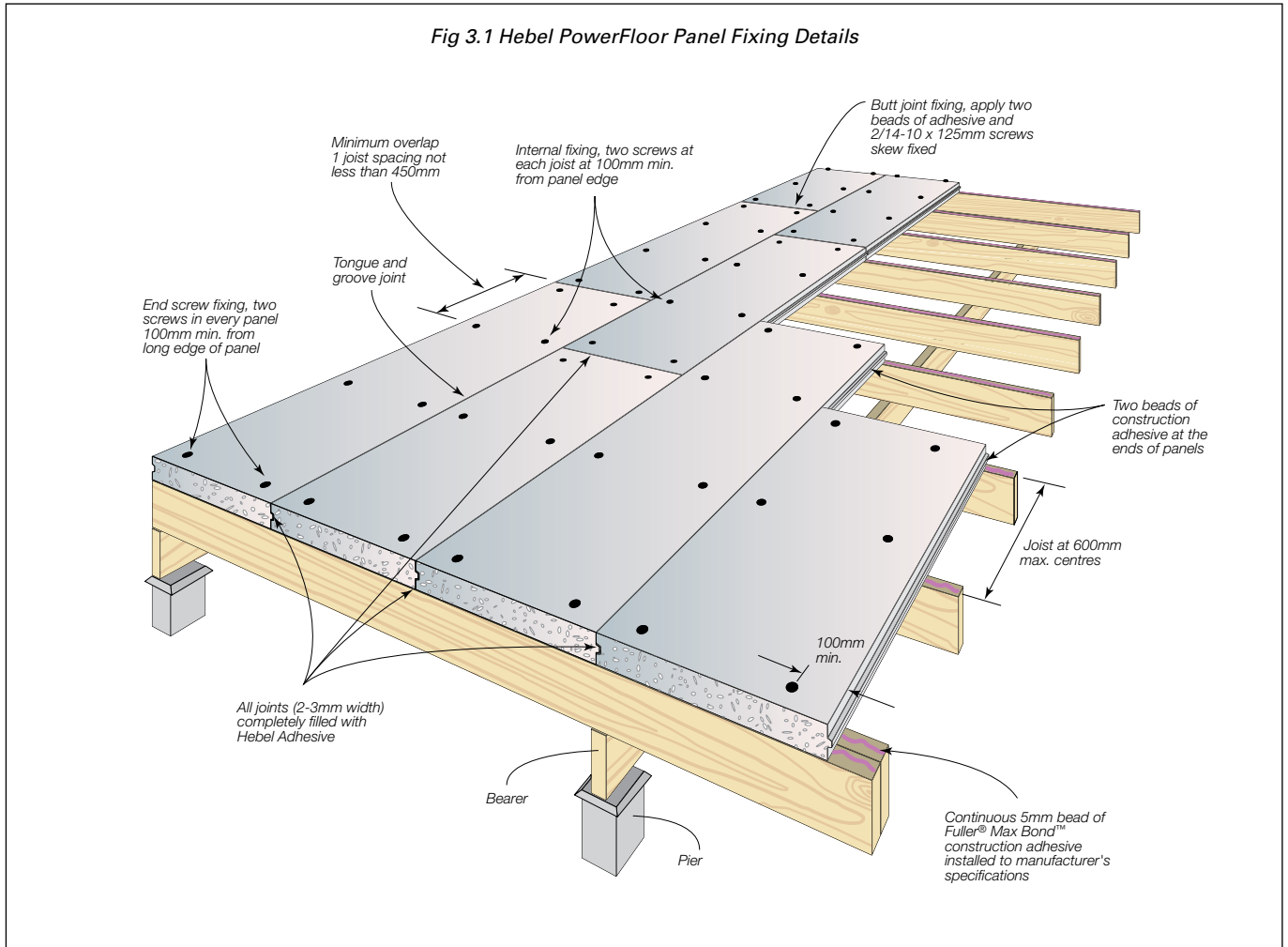
\*\* Suitable underfloor insulation may be installed to achieve floor R-value of R1.3 as required by NZBC Clause H1 (Energy Efficiency).

\*\*\* Thermal R-values in table include the addition of floor covering.

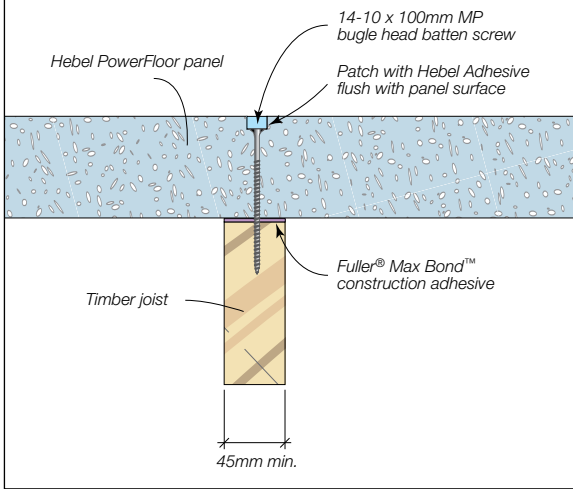
\*\*\*\* The acoustic performance is based on systems using 8mm ceramic tiles, 30mm concrete screed, min. 4.5mm Rubber underlay, min. 90mm ceiling batts R1.8, Resilient mounts, 28mm Rondo Furring Channels: cc 600mm and joist size of 190mm.

**IMPORTANT:** The NZ Code sound insulation requirements states a separating floor between occupancies to achieve a STC ≥ 55 and IIC ≥ 55. Bold figures equal NZ compliance.

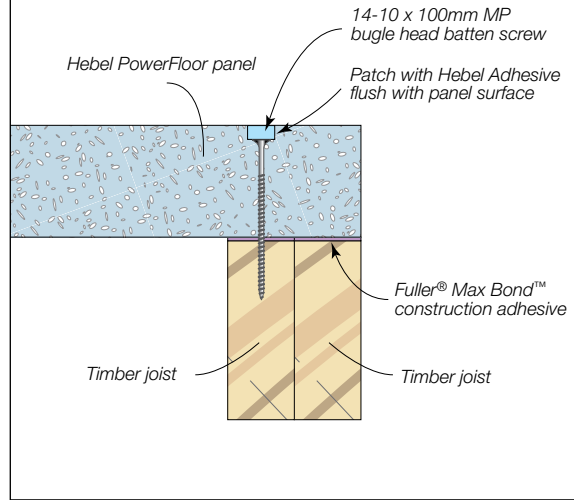
# 3.3 Hebel PowerFloor Panel Fixing Details



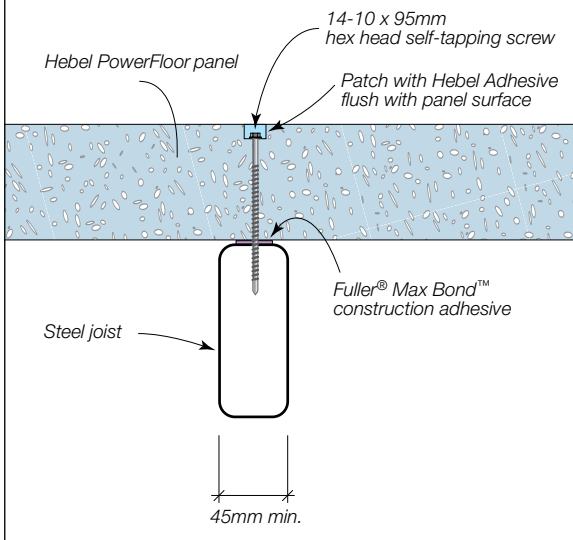
**Fig 3.3 Fixing of Hebel PowerFloor Panel to Timber Joists**



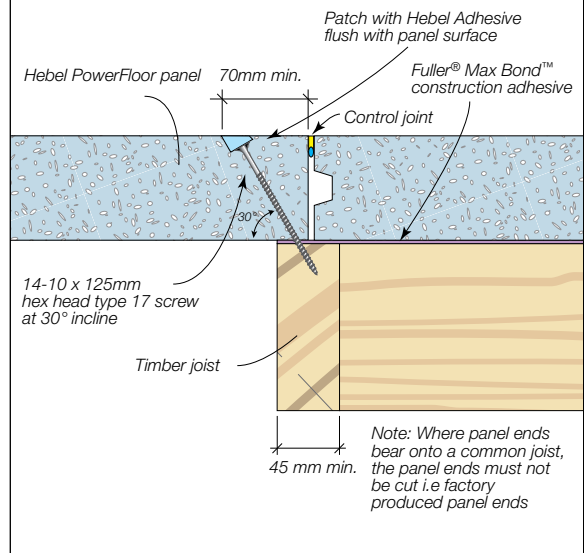
**Fig 3.4 Fixing at End of Hebel PowerFloor Panel to Timber Joists**



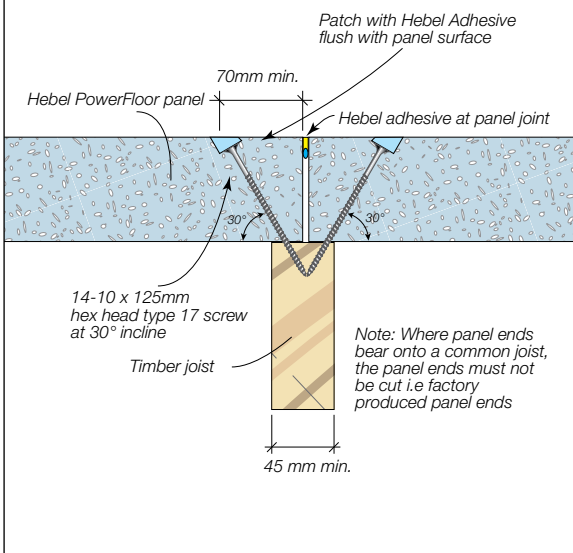
**Fig 3.5 Fixing of Hebel PowerFloor Panel to Steel Joists**



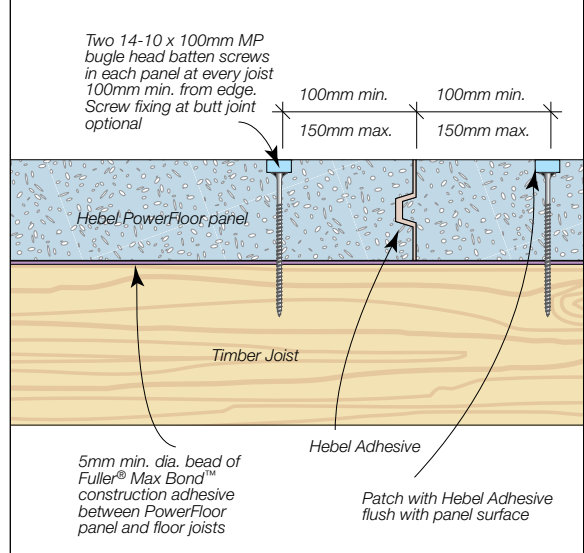
**Fig 3.6 Fixing to Timber Joists at change in Joist Orientation**



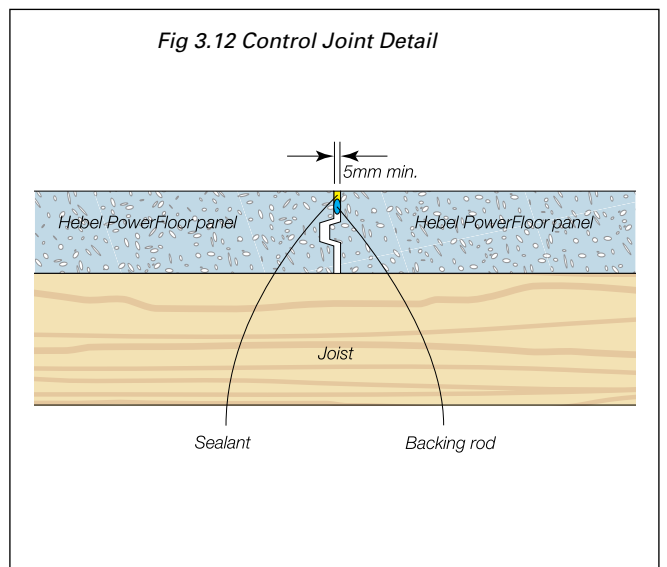
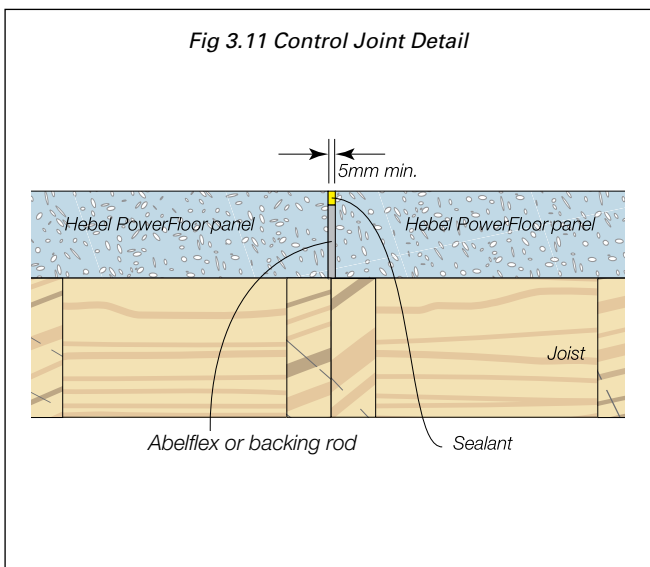
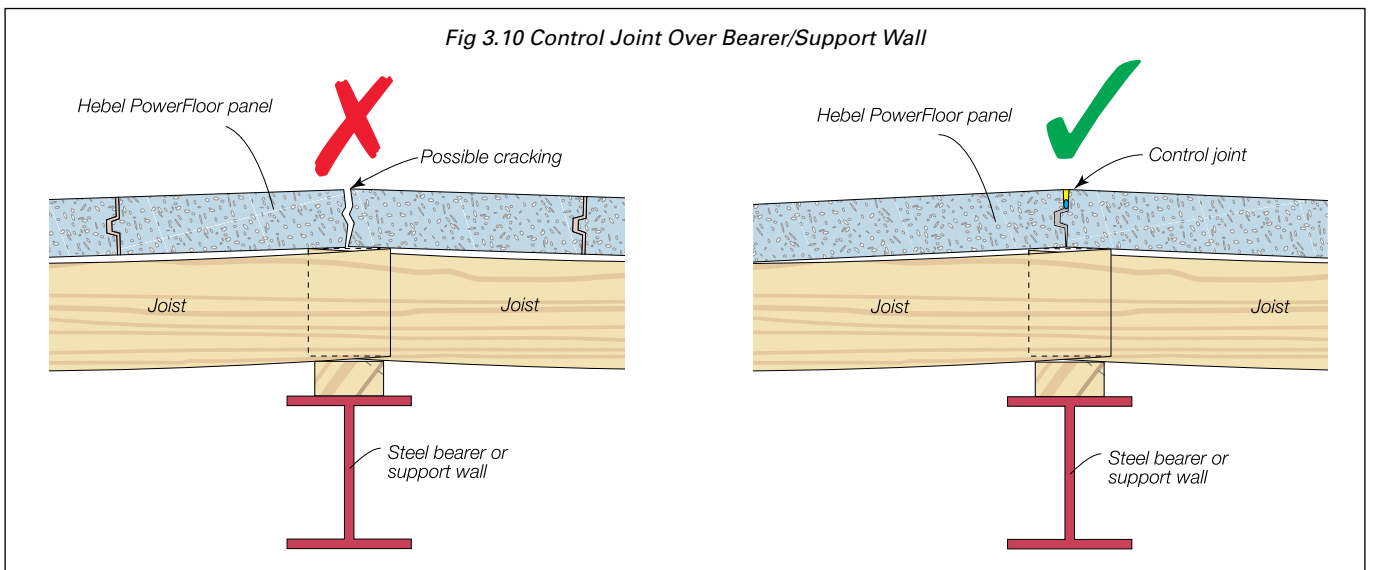
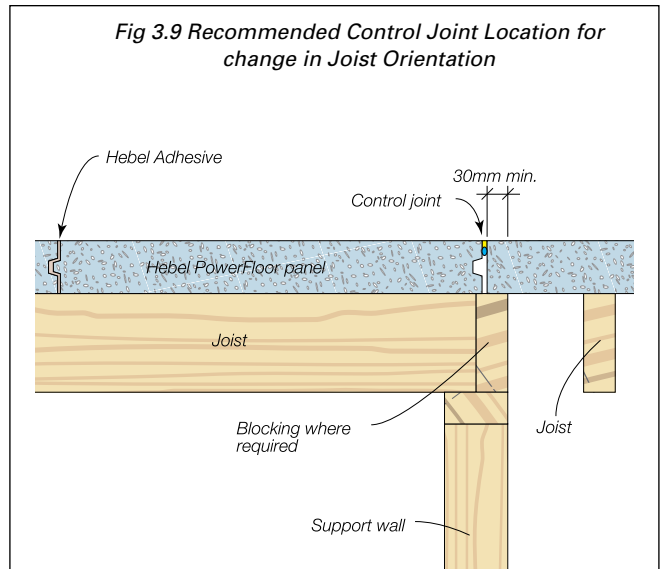
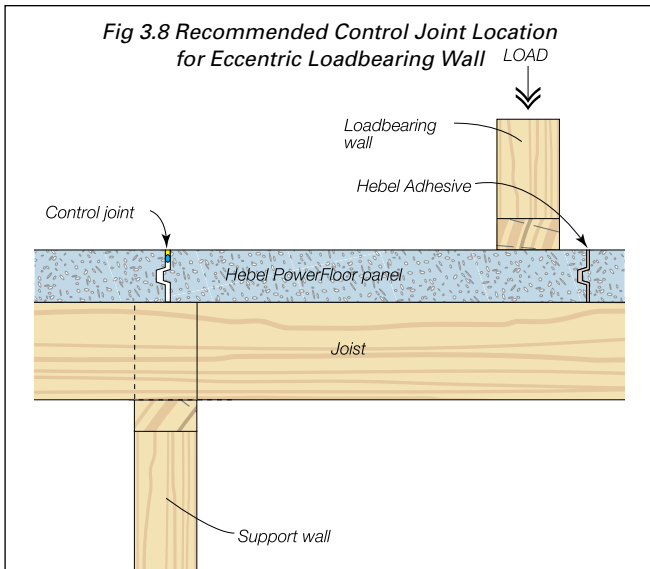
**Fig 3.6a Fixing of Hebel PowerFloor Panel to Timber Joists**



**Fig 3.7 Cross-section of Hebel PowerFloor Panel Installation**

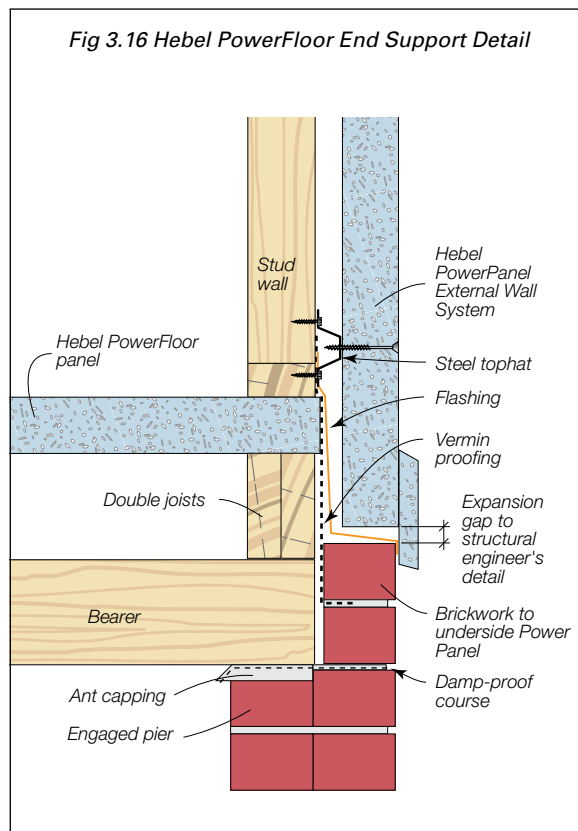
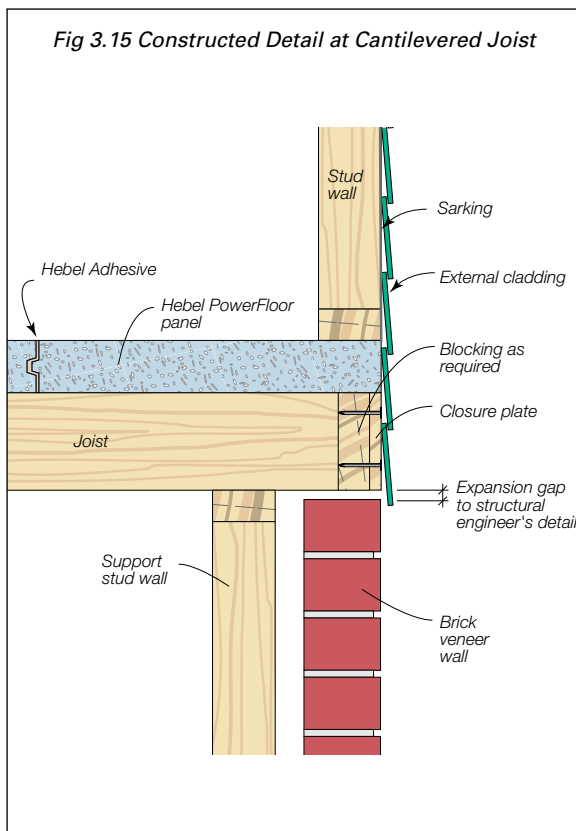
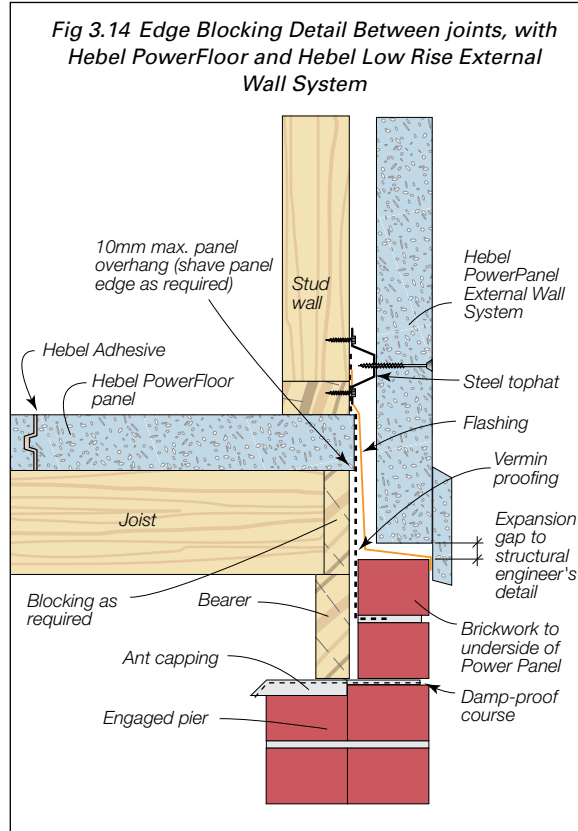
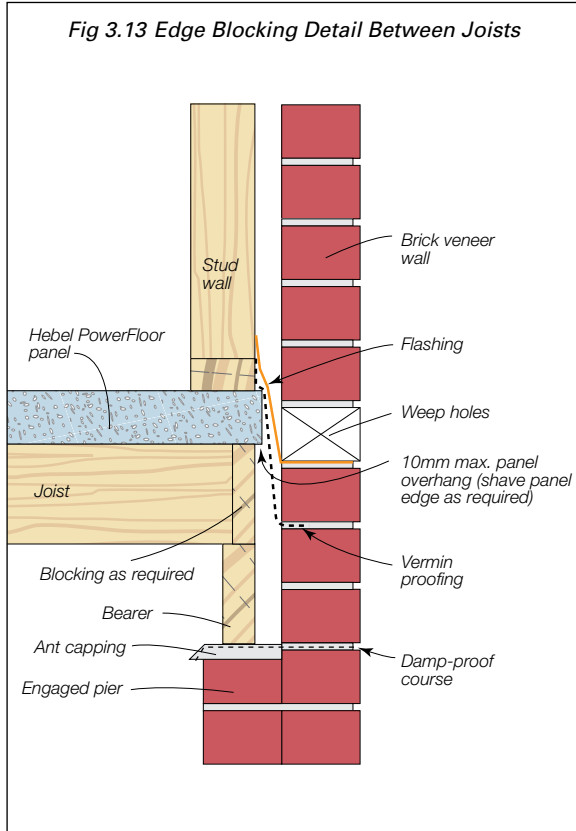


# 3.4 Control Joint Details

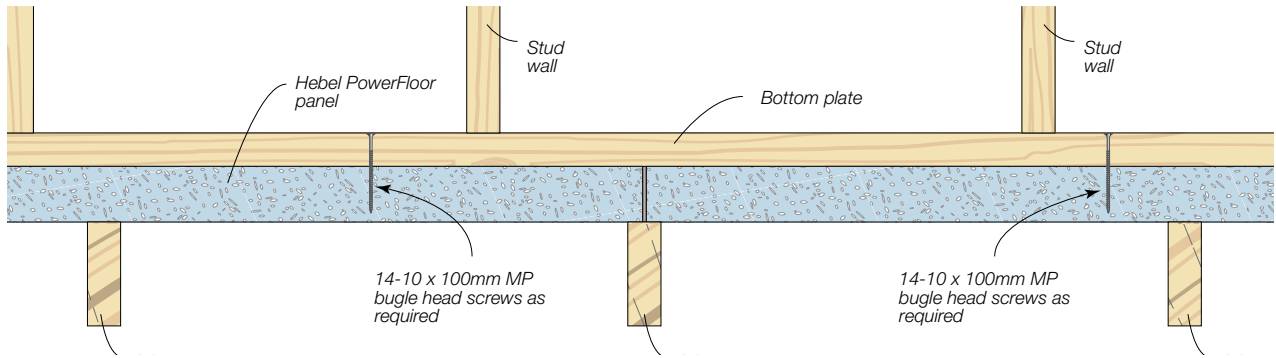


# 3.5 Construction Details

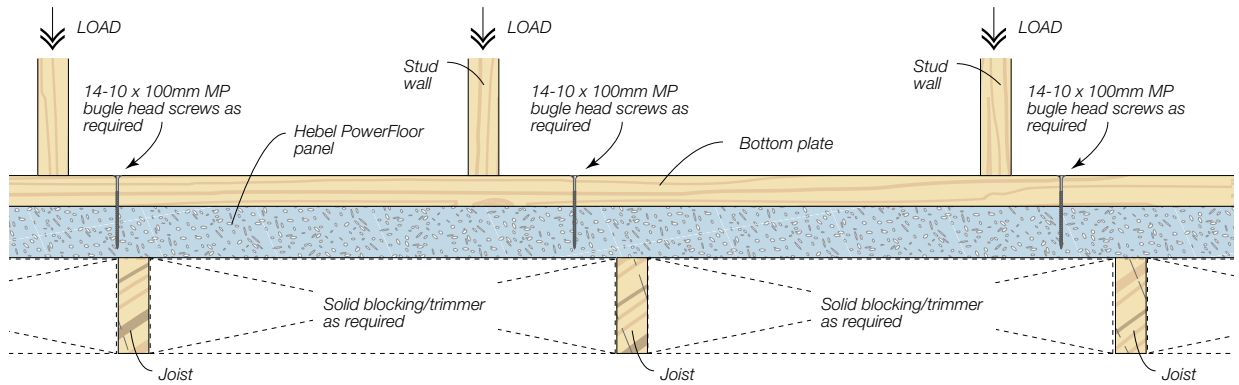
**NOTE:** The detailing of the cladding system shown below is for indicative purposes only. The project designer shall specify the construction details for the project.



**Fig 3.17 Typical Bottom Plate Fixing for Non-bracing Partition Walls**

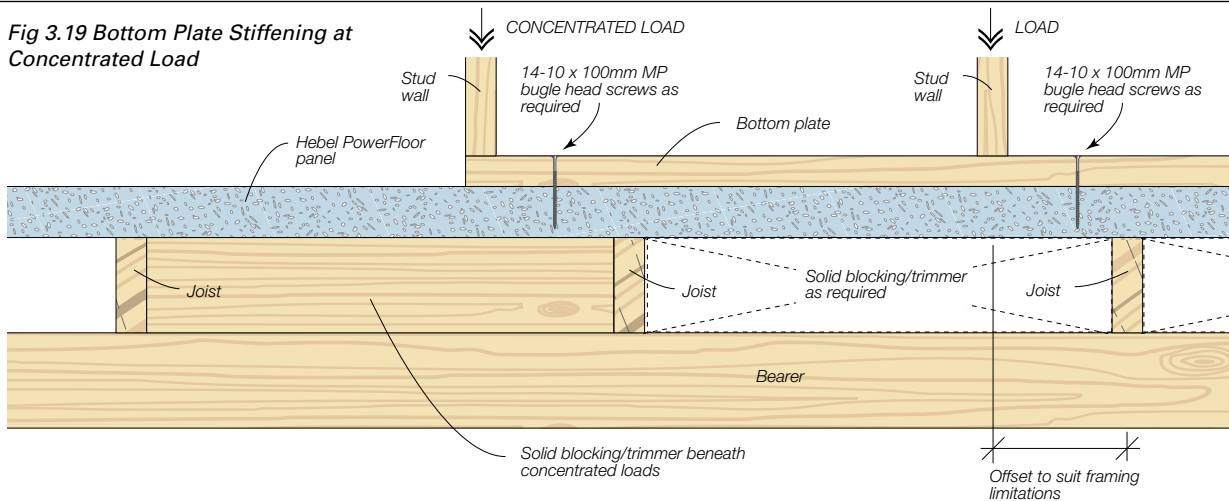


**Fig 3.18 Joists Blocking Detail Under Loadbearing Walls Running Perpendicular to Joists**

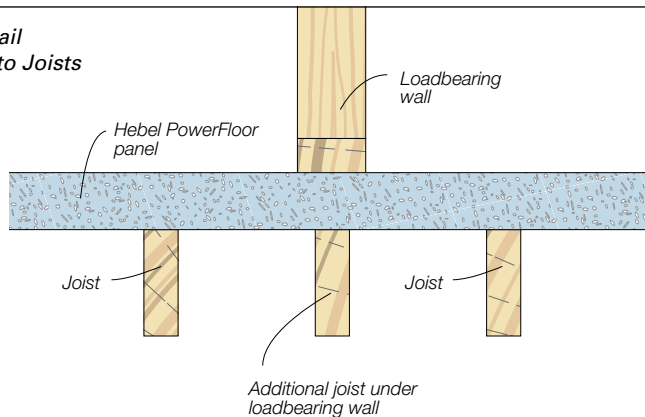


Note: 1. Where consideration for uplift is required, then fixing of the bottom plate must extend through the floor support framing below.  
2. Anchorage to bracing panels need to be provided by a suitably qualified person.

**Fig 3.19 Bottom Plate Stiffening at Concentrated Load**

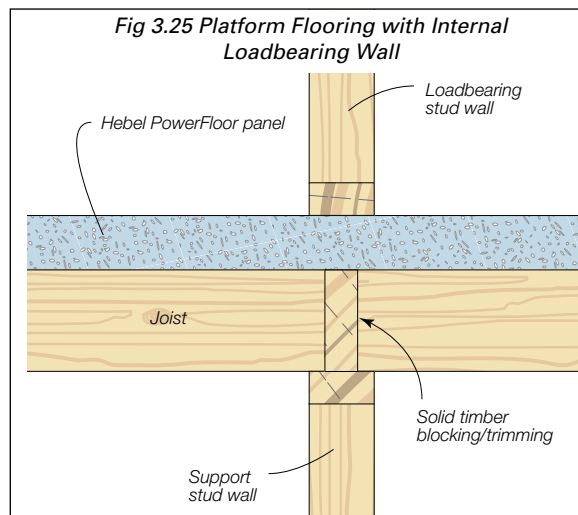
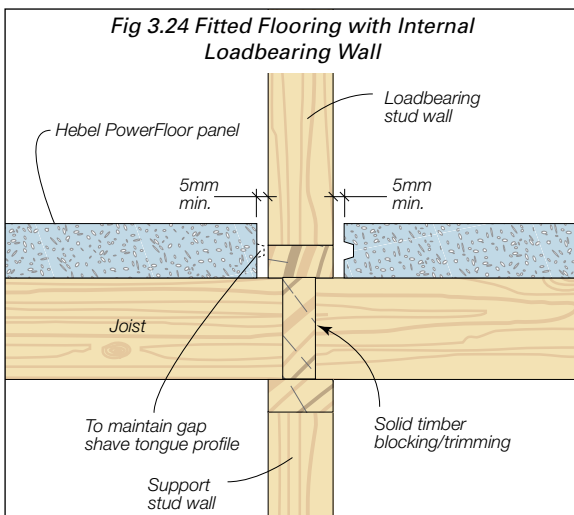
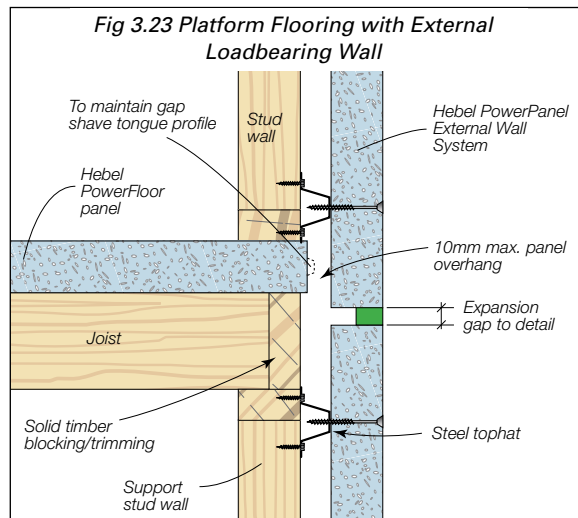
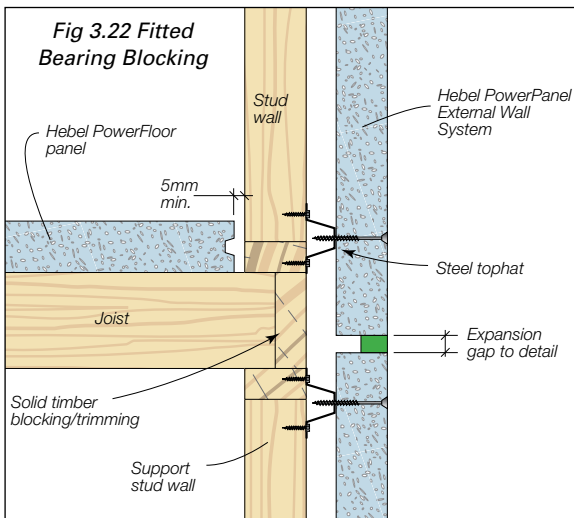
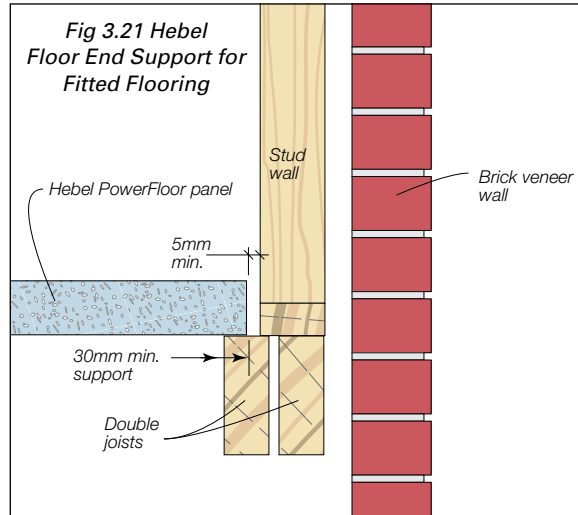
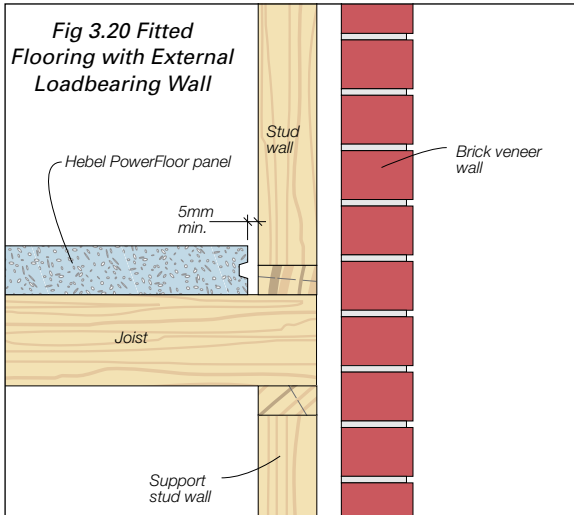


**Fig 3.19a. Additional Support Detail Under Loadbearing Wall Parallel to Joists**



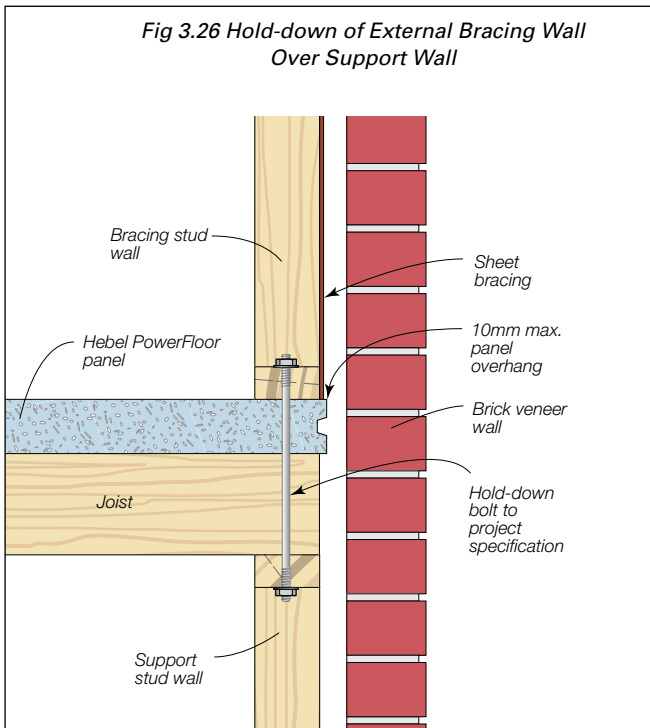
# 3.6 Multi-Level Construction Details

**NOTE:** • Fitted flooring is required where the bearing stress in the Hebel PowerFloor panel, at the top of joists or the top of blocking between joists exceeds 1MPa.  
 • The detailing of the cladding system shown below is for indicative purposes only.  
 The project designer shall specify the construction details for the project.

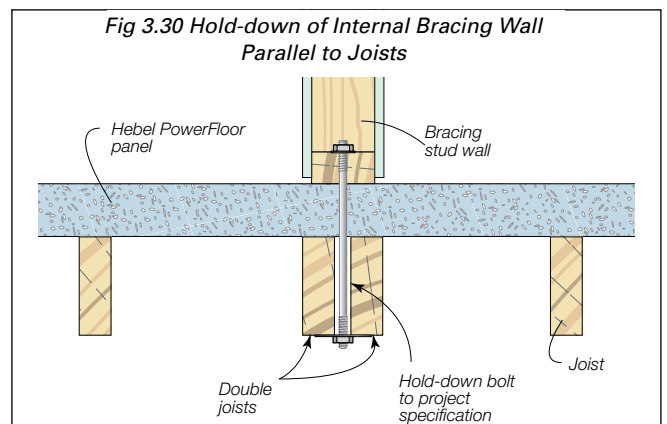
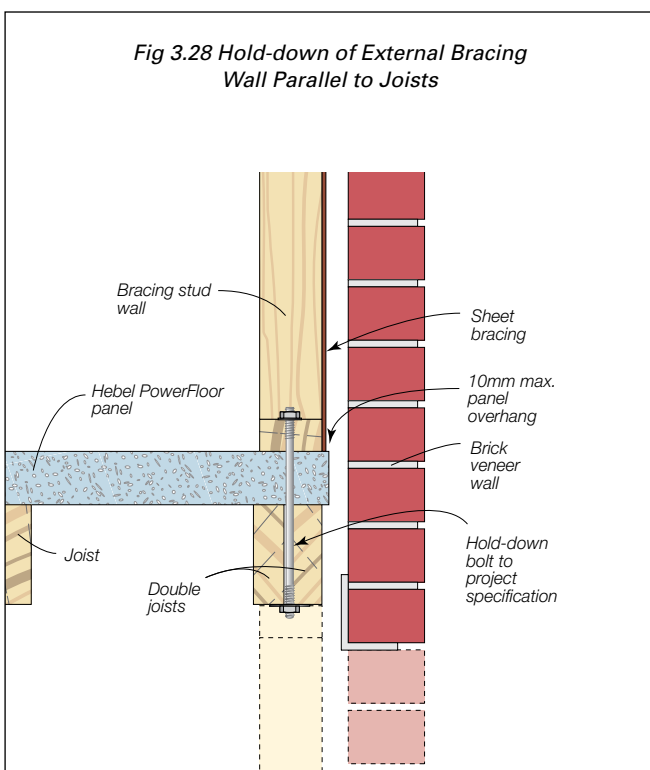
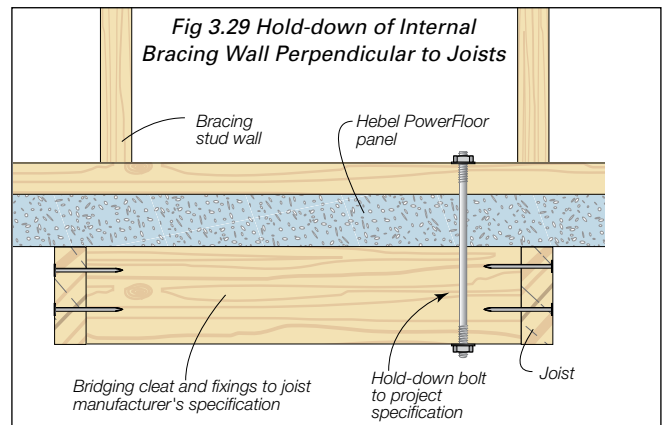
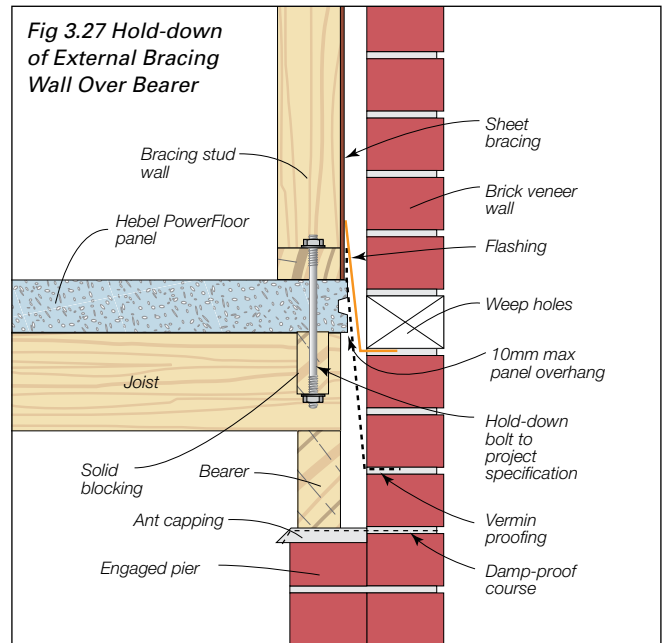


# 3.7 Hold-Down/Bracing Wall Details

- NOTE:**
- Hold down connection to meet requirements of the selected bracing system.
  - For hold-down connections other than bolts, ensure the minimum requirements for embedment into timber is maintained.
  - The detailing of the cladding system shown below is for indicative purposes only. The project designer shall specify the construction details for the project.

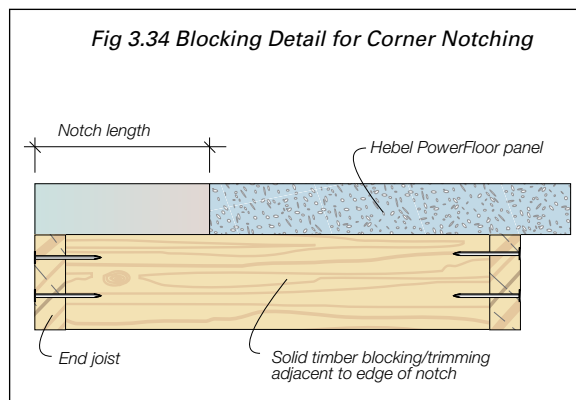
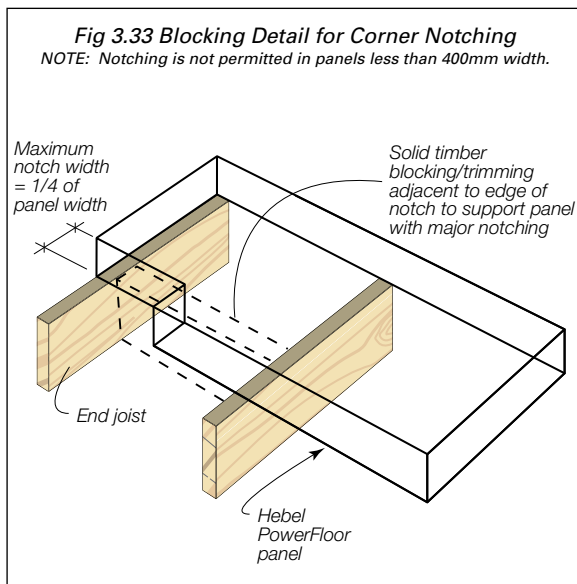
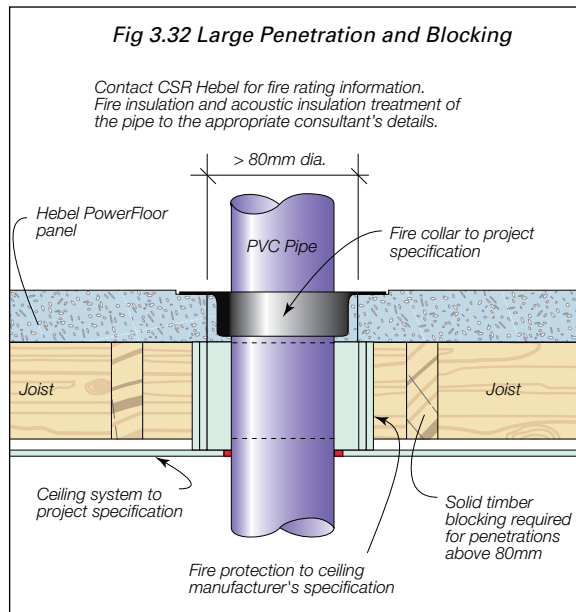
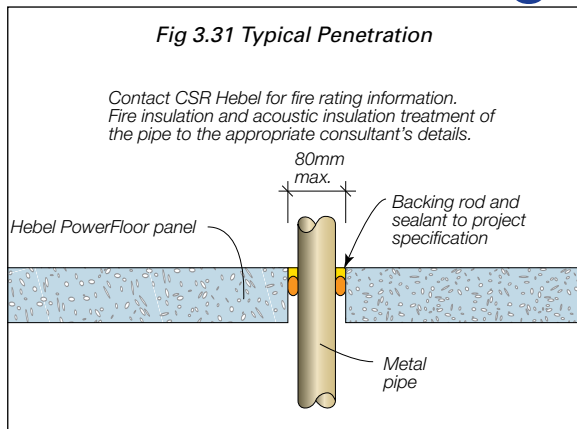


Note: Anchorage to bracing panels need to be provided by a suitably qualified person.





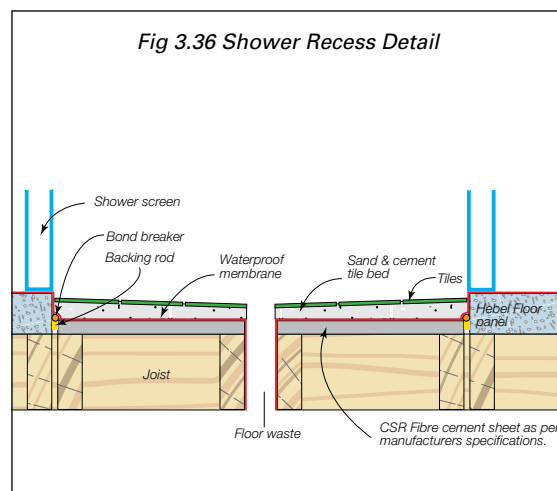
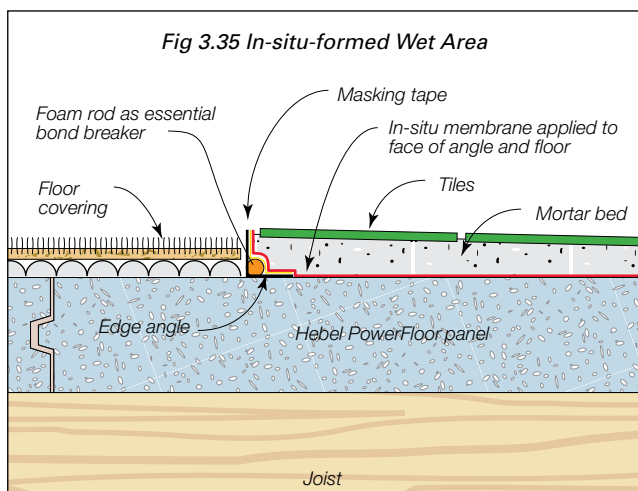
# 3.8 Penetrations and Notching Details



Note: It is the responsibility of the project design engineer to take into account larger openings within the diaphragm floor structure such as for stairs etc when designing the floor system for in-plane shear forces.

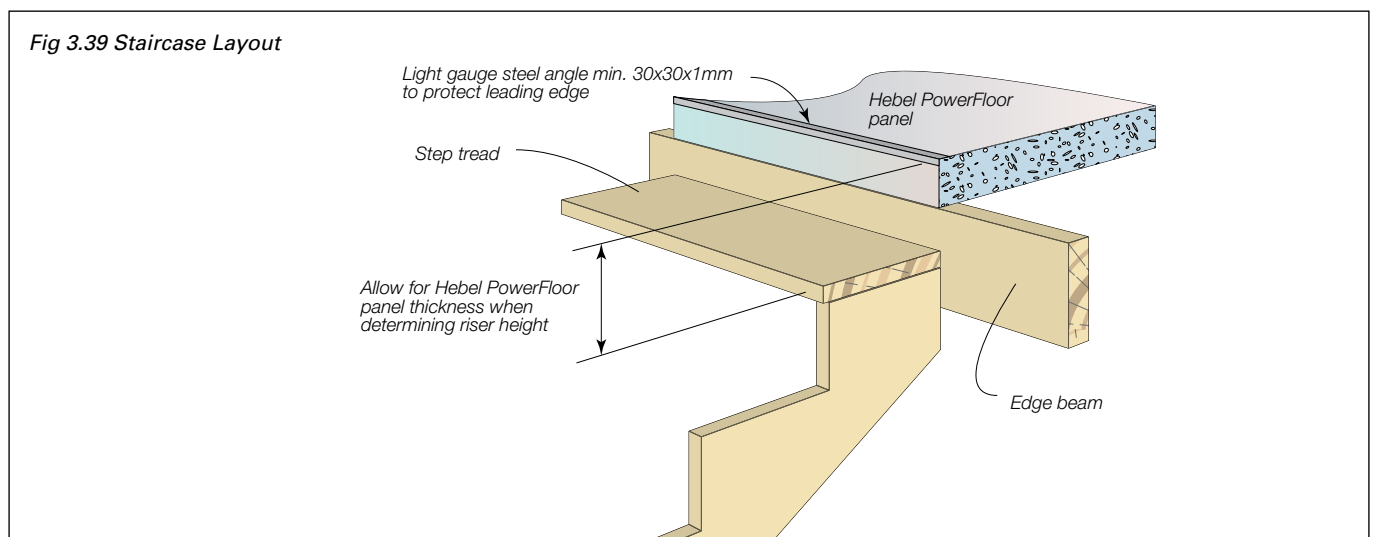
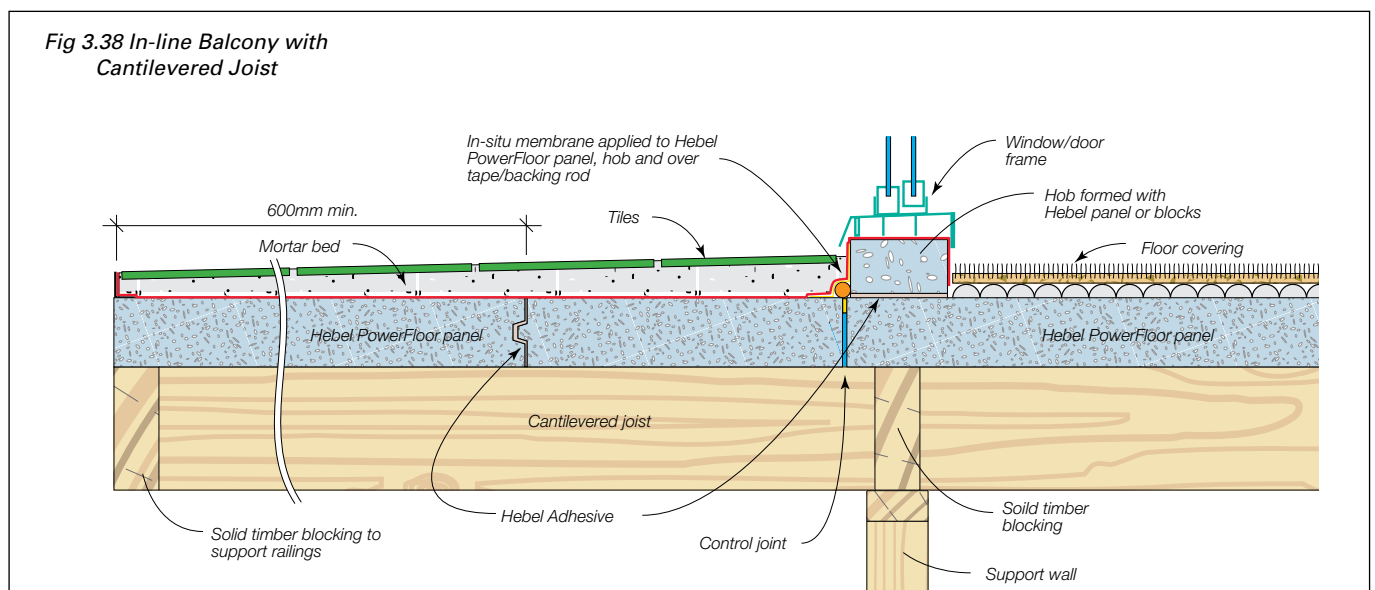
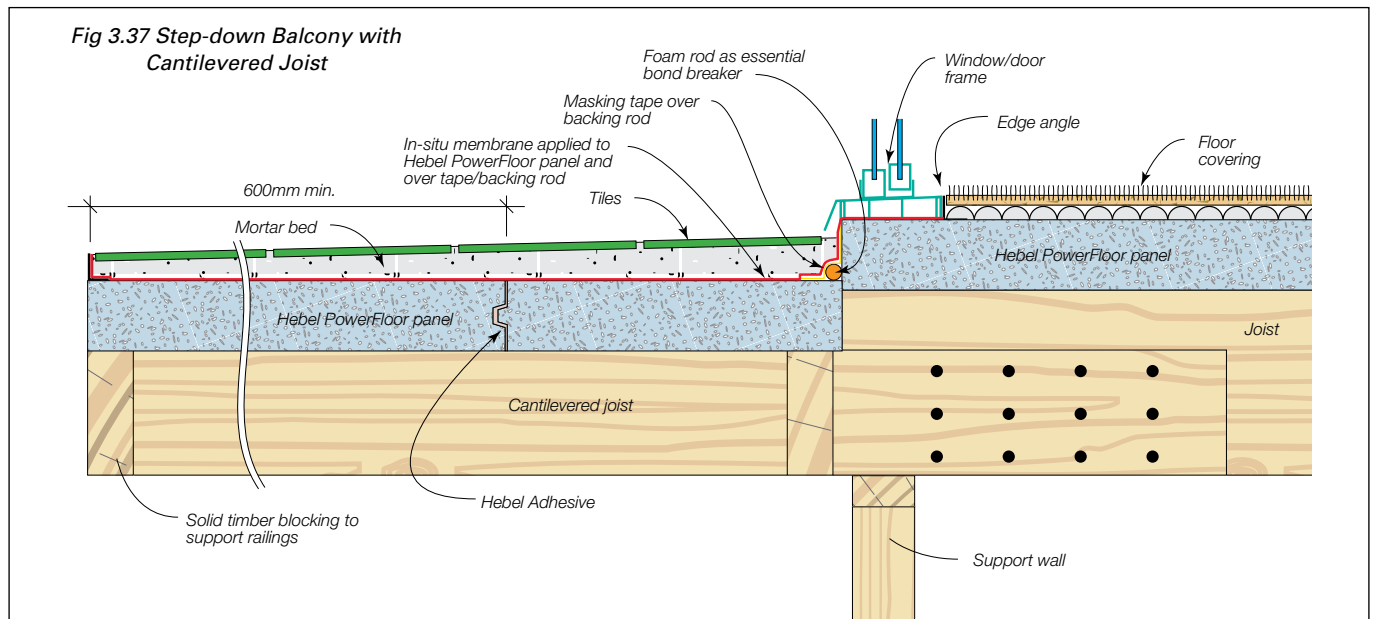
# 3.9 Wet Area Detail

Note: These are indicative details only. Wet area design & detailing including junctions is the responsibility of the project designer



# 3.10 Balcony and Staircase Details

NOTE: • These are indicative details only. Balcony design and weather tight consideration is the responsibility of the project designer.



# 3.11 Floor Covering Installation

The following sections describe the type of preparation required and any special considerations for common floor coverings.

## Carpet Installation

### Panel Surface Preparation

Sweep the floor surface to remove debris and loose particles. Expose all surface blemishes such as chips, cracks, gaps, ridges or the like. Fill all unacceptable locations with an appropriate and compatible patching compound such as Hebel Patch or levelling compound as required. Ensure panels are then dry.



### Carpet Smooth Edge Installation

Installation of Carpet Smooth Edge (Gripper) is to be in accordance with AS/NZS 2455.1:1995.

Installation of carpet gripper prior to laying carpet requires the use of specifically selected nails or course threaded screws. Standard fixings supplied with the carpet gripper are not suitable for fixing to Hebel PowerFloor panels. Carpet gripper strips are available without factory supplied nails. For carpet gripper installation near the panel edge, only glue is recommended. If relying on glue only, the carpet

can not be stretched until the glue is set after approximately 24 hours.

### Underlay Installation

Minimum medium duty underlay is to be used. No other special requirements.

### Carpet Installation

As per carpet manufacturer's guidelines. No other special requirements.

Fig 3.40



Fig 3.41



Fixing Type	Description	Application Method	Installation Notes
Twist Nails	51mm dome head twist nail	Coil Nail Gun (Refer to Fig 7.1)	The head of the twist nail should finish flush with the surface of the gripper strip
Screws	Type 17 point - course thread No. 8g x 50mm - Countersinking screw	Makita 6834 Auto Feed Screwdriver (Refer to Fig 7.2)	The head of the twist nail should finish flush with the surface of the carpet gripper strip

# 3.12 Tile Installation

## Panel Surface Preparation

Sweep the floor surface to remove debris and loose particles. Expose all surface blemishes such as chips, cracks, gaps, ridges or the like. Fill all unacceptable locations with an appropriate and compatible patching compound such as Hebel Patch or levelling compound as required. Ensure panels are then dry.

Case 1 Direct Stick Adhesive	Case 2 On Screed
<ul style="list-style-type: none"> <li>• Sealer as per manufacturer's recommendations</li> <li>• Waterproof membrane as required, for balconies and wet areas</li> </ul>	<ul style="list-style-type: none"> <li>• Sealer as per manufacturer's recommendations</li> </ul>

## Tile Installation

As per manufacturer's guidelines. Apply tiles to screed or adhesive as per normal floor.

**Notes:** **Control Joints** - ensure Control Joints are installed in tiles at the appropriate location of floor Control Joints.  
**Penetration** - seal penetrations through waterproof membrane.

**Note:** The use of an acoustic underlay may be required in order to achieve the desired impact isolation Class (IIC) rating. Consult the project specification.



# 3.13 Vinyl Installation

## Panel Surface Preparation

Sweep the floor surface to remove debris and loose particles. Expose all surface blemishes such as chips, cracks, gaps, ridges or the like. Fill all unacceptable locations with an appropriate and compatible patching compound such as Hebel Patch or levelling compound as required. Ensure panels are then dry.

**Notes:**

1. Ensure panel preparation is completed properly and thoroughly to avoid crunching.
2. When screed is used, ensure that the additional load is taken into account in the sub floor design.

**Note:** The use of an acoustic underlay may be required in order to achieve the desired impact isolation Class (IIC) rating. Consult the project specification.

Components	Case 1 - Screed	Case 2 - Masonite
Concrete screed	As per tiles	Not required
Masonite	Not required	Install with twist nails as with carpet smooth edge
Vinyl	As per standard practice (no special requirements)	As per standard practice (no special requirements)

## 3.14 Timber Installation

### Panel Surface Preparation

Sweep the floor surface to remove debris and loose particles. Expose all surface blemishes such as chips, cracks, gaps, ridges or the like. Fill all unacceptable locations with an appropriate and compatible patching compound such as Hebel Patch or levelling compound as required. Ensure panels are then dry.

### Moisture

Timber is affected by changes in environmental conditions and it is good practice to allow the flooring to acclimatise to the environment before installation. If there is significant moisture in the Hebel PowerFloor (>6%) a membrane, such as min. 200 micron polyethylene sheeting, should be placed over the top surface of the Hebel PowerFloor.

### Timber Strip Flooring

Batten fix - ensuring flatness is not as critical as direct mechanical fix. Anchor battens at the required centres using anchors suitable for AAC, eg. Mungo MBSP1080.

Direct mechanical fix - install min. 12mm plywood sheets to Hebel PowerFloor using construction Maxbond or equivalent and 65-75mm coarse thread countersunk screws at max 600mm centres.

### Floating Timber Floor

Underlay / backing installed as per normal for a concrete slab.

No special requirements for floating timber flooring installation.

*Note: The use of an acoustic underlay may be required in order to achieve the desired impact isolation Class (IIC) rating. Consult the project specification.*

Fig 3.42 Timber Floor Covering



# 4.1 Delivery and storage

## Unloading Panel Packs

Panel packs shall be unloaded and moved with only approved lifting devices. Before use, the lifting devices should be checked for the required lifting tags. Packs should be unloaded as close as possible to the intended installation area. This will increase work efficiency and minimise the need for secondary lifting.

**NOTE:** Secondary handling increases the risk of panel damage. The repair of damage sustained during lifting and moving is the responsibility of the lifter. Where damage is excessive, PowerFloor panels must be replaced.

## Storage

All materials must be kept dry and preferably stored undercover. Care should be taken to avoid sagging or damage to ends, edges and surfaces.

All Hebel products must be stacked on edge and properly supported off the ground, on a level platform. Panel bundles can be stacked two high. The project engineer should be consulted as to the adequacy of the structure to support the stacked bundles.

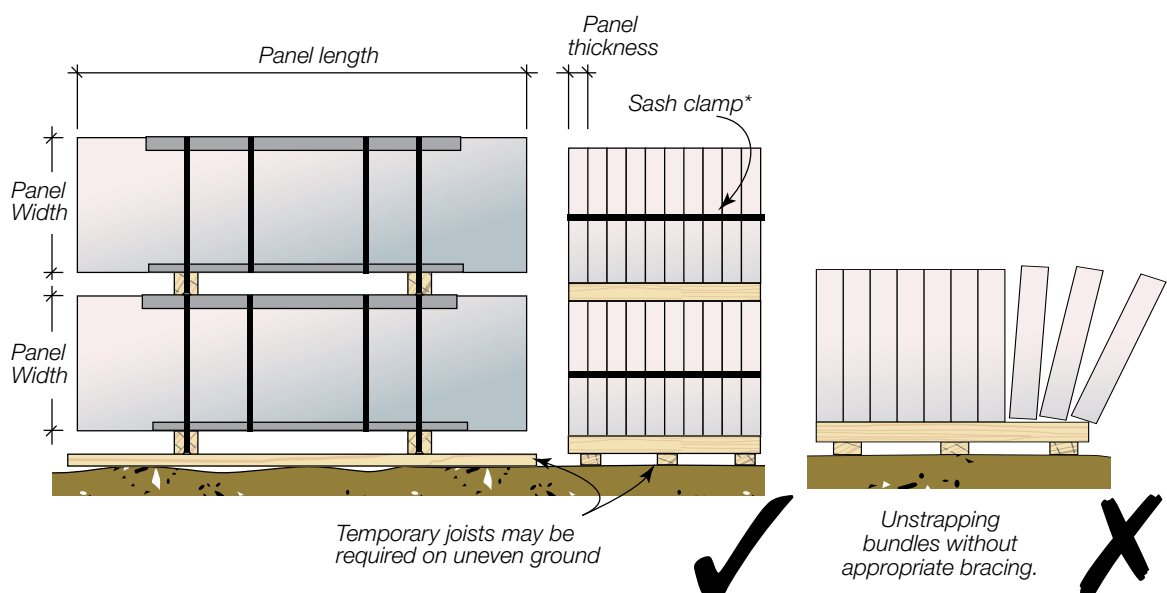
If outside, Hebel panels must be stored off the ground and protected from the weather. Only single bundles positioned on the ground can be opened. To provide a level surface, we recommend placing temporary joists beneath the supporting cleats.

## Unstrapping Packs

Ensure appropriate bracing is installed to packs prior to removal of strapping to prevent panels from falling. Panels can be held together with sash clamps, ratchet, straps or Hebel stabilising bars.



Fig. 4.1 Stacking Packs of Hebel PowerClad



## 4.2 Tools and Equipment

The basic tools required to assist in the installation of the Hebel PowerFloor are shown in Figure 4.1.

These may be purchased through CSR Hebel and include:

1. Stirrer
2. Trowel
3. Sanding float
4. Panel lifters
5. Levelling plane

Extra equipment will also be required and includes the following:

- Power drill (clutch driven)
- Power saw with metal or diamond tipped cutting blades
- Dust extraction system
- Sockets and bits for screws
- Personal Protective Equipment (PPE) such as goggles, face mask and P1/P2 dust masks, used when site cutting the panels

Fig 4.1 The Basic Tools and Equipment Requirements



# 4.3 Panel Installation

## Installation Procedures

CSR Hebel promotes and advocates a safety conscious work place at all times. To assist builders and contractors to maintain their safety standards, CSR Hebel has produced guidelines for the installation and handling of their products. Contact CSR Hebel for additional information.

## Mortars & Adhesives

The Hebel bagged mortar and adhesive should be prepared in accordance with instructions on the packaging.

## Damaged Panels

Chipped or damaged panels are to be repaired using Hebel Patching Mortar. Your Hebel supplier should be notified immediately of any panel damage or cracking that occurs during the handling of the panels. This damage may result in the panel being structurally inadequate, in which case it must be replaced.

## Panel Cutting

Hebel PowerFloor Panels to be cut with a circular saw fitted with a diamond tipped blade. The use of power tools may cause dust, which contains respirable crystalline silica, with the potential to cause bronchitis, silicosis and lung cancer after repeated and prolonged exposure. When using power or hand tools on Hebel products, wear a P1 or P2 respirator and eye protection. When cutting, routing or chasing Hebel products with power tools, use dust extraction equipment and wear hearing protection. Refer to CSR Hebel MSDS sheets. For further information, contact CSR Hebel or visit our website: [www.hebel.co.nz](http://www.hebel.co.nz)

Reinforcement exposed during cutting is to be coated with a liberal application of Hebel anti-corrosion protection paint.



## 4.4 Panel Handling

### Manual Handling

CSR Hebel recommends using a trolley or other mechanical apparatus to move the panels around the work site. Manual handling, where people physically move a panel, should be kept to a minimum, with the weight being supported by an individual kept as small as possible. Any concerns regarding the weight to be handled should be discussed with the panel installing contractor.

To minimise the possibility of manual handling injuries, CSR Hebel suggests the following:

- Use mechanical aids, such as trolleys, fork lifts, cranes and levers, or team lifting to move panels.

- Keep the work place clean to reduce the risk of slips, trips and falls which can cause injury.
- Plan the sequence of installation to minimise panel movements and avoid awkward lifts.
- Keep the panels dry.
- Train employees in good lifting techniques to minimise the risk of injury.

Hebel products are cement-based, which may irritate the skin, resulting in itching and occasionally a red rash. The wearing of gloves and suitable clothing to reduce abrasion and irritation of the skin is recommended when handling Hebel products.



# Appendix A: Hebel PowerFloor Material Properties

## A.1 Manufacturing Tolerances

Length	± 5.0mm
Width	±1.5mm
Thickness	±1.5mm
Diagonals (Max.)	5mm
Edge straightness deviation (Max.)	1.5mm

## A.2 Hebel PowerFloor Physical Properties

- Hebel PowerFloor profile and nominal dimensions are shown in Section 3.3.
- Panel reinforcement is a single layer of steel mesh with 4 longitudinal wires of 5mm diameter.
- Nominal dry density = 510 kg/m<sup>3</sup>.
- Average working density = 688 kg/m<sup>3</sup> at 35% moisture content.
- Average service life density = 561 kg/m<sup>3</sup> at 10% moisture content.

## A.3 Hebel PowerFloor Strength Properties

- Characteristic Compressive Strength or AAC,  $f'_{m} = 2.8$  MPa.
- Average Compressive Strength of AAC = 4.0 MPa.
- Characteristic Modulus of Rupture,  $f'_{ut} = 0.60$  MPa.

## A.4 Hebel PowerFloor Acoustic Properties

- Panel only with no plasterboard or other lining  
 $R_w = 36$ dB,  $R_w + C_{tr} = 33$ dB  
(refer to acoustic test ATF-676).

## A.5 Hebel PowerFloor Thermal Properties

- R-Value of PowerPanel with no plasterboard or other lining = 0.375 m<sup>2</sup>. K/W (14% moisture content).

## A.6 Fire Resistance Level (FRR) Ratings

For fire performance characteristics of Hebel PowerFloor, refer to Section 2.1 of this guide.

# Appendix B:

## Estimating Hebel PowerFloor

Following is a guide to assist in working out quantities and costs for the required components of the Hebel PowerFloor system when installed on timber joists.

### Step 1: Calculation of the Total Floor Area

First calculate the total floor area of the building, allowing for the panels to extend UNDER the external wall frames.

The easiest way for this to be calculated is to determine the overall wall length of the area being calculated, as measured over wall frames. Below is a diagram of a house where the wall frames are 90mm thick and the plan measurements are given 'over frame', so given the plan dimensions the area would be worked out as follows:

- **Total Floor Area (TFA) = 14 x 7 = 98 m<sup>2</sup> (total area to the outside of the stud frame)**

### Step 2: Panel Waste

**This can be calculated in two ways:**

An accurate calculation by completing a detailed panel layout and measuring the amount of waste that will be generated due to the layout of the house. Or By applying a waste percentage to the Total Floor Area. Generally allow an additional 8% of area. Therefore multiply the Total Floor Area by 1.08. This calculation gives you the Total Adjusted Floor Area (TAFA).

### Step 3: Material Quantities

Now that the floor area has been worked out we can move on to estimating out the material quantities.

#### (A) Hebel PowerFloor Panels:

- Area of one panel = (1.8m x 0.6m) = 1.08m<sup>2</sup>
- No. of panels = Total Adjusted Floor Area (TAFA) ÷ 1.08m<sup>2</sup>

#### (B) Screws

- Joists @ 450cts  
= 6.5 x 100mm screws required per m<sup>2</sup> of floor  
+ 3.5 x (125)mm screws per m<sup>2</sup> of floor (at butt joints)
- Joists @ 600cts  
= 4.5 x 100mm screws required per m<sup>2</sup> of floor  
+ 3.5 x (125)mm screws per m<sup>2</sup> of floor (at butt joints)

*Note: Packs come in 2 sizes, 100 or 250.*

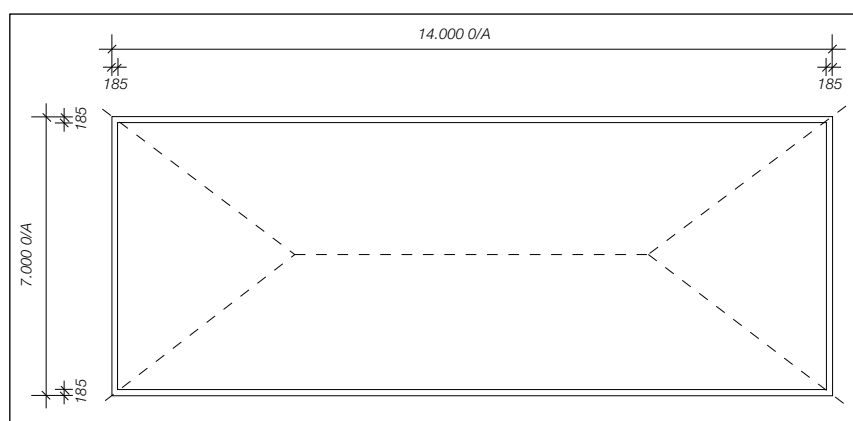
*Screws to be estimated based on the pack sizes.*

#### (C) Hebel Adhesive

- Each 20kg bag of Hebel Adhesive glues 20m<sup>2</sup> of floor area.
- Total bags = Total Floor Area (TFA) ÷ 20

#### (D) Construction Adhesive

- Each tube of construction adhesive glues approx. 10 panels to the sub floor joists. This is 10 x 1.08m<sup>2</sup> = 10.8m<sup>2</sup> of floor area.
- Total tubes of adhesive  
= Total Floor Area (TFA) ÷ 10.8



# Appendix B:

## Estimating Hebel PowerFloor (Cont.)

Client Details				
Date				
Client Name				
Client Address				
Client Phone				
Client Fax				
Client Email				
	Total Floor Area (TFA) =	1.08 m <sup>2</sup>		
	Total Adjusted Floor Area (TAFA) =	1.05 x TFA =		m <sup>2</sup>
Item		Quantity	Cost / Unit	Total Cost
Panels	TFA ÷ 1.08 =			\$
Screws (100mm for fixing into timber or steel joists) (Joists @ 600)	TFA x 4.5 =		(250)	\$
OR				
(Joist @ 450)	TFA x 6.5 =		(100)	\$
			(250)	\$
Screws (125mm for fixing into timber joists or 135mm screws for fixing into steel joists ) (Joists @ 600 or 450)	TFA x 3.5 =		(100)	\$
Hebel Adhesive	TFA ÷ 20 =			\$
Construction Adhesive	TFA ÷ 10.8 =			\$
<b>TOTAL</b>				<b>\$</b>









## CSR HEBEL

14 The Furlong, Takanini, Auckland  
P O Box 188, Takanini, Auckland 2245

### Health & safety

Information on any known health risks of our products and how to handle them safely is on product packaging and / or the accompanying documentation. Additional information is listed in the Safety Data Sheet (SDS). To obtain a copy of a SDS, download from [www.hebel.co.nz](http://www.hebel.co.nz). Contractors are required by law to perform their own risk assessments before undertaking work.

### Performance & certification

Hebel® products and systems are developed in Australia by CSR Building Products. ABN. 55 008 631 356. It is a manufacturer and supplier of Hebel Autoclaved Aerated Concrete (AAC) products. Because it is a manufacturer and supplier only, CSR does not employ people qualified as Accredited or Principal Certifiers. CSR is therefore unable to provide Construction Compliance Certificates or Statements of Compliance. CSR conducts appropriate testing of its products and systems to determine performance levels. These include structural, fire and acoustic tests. Testing is conducted and certified by appropriate specialists in these fields. When using Hebel products and systems in specific projects, such specialists should be consulted to ensure compliance with the NZBC & NZ Standard.

### Disclaimer

Information presented in this document is supplied in good faith and to the best of our knowledge was accurate at the time of preparation. The provision of this information should not be construed as a recommendation to use any of our products in violation of any patent rights or in breach of any statute or regulation. Users are advised to make their own determination as to the suitability of this information in relation to their particular purpose or specific circumstances. Since the information contained in this document may be applied under conditions beyond our control, no responsibility can be accepted by CSR, or its staff for any loss or damage caused by any person acting or refraining from action as a result of misuse of this information.

### Other

The design of a wall, floor or fence system requires the services of professional consultants. This document has been prepared as a source of information to provide general guidance to those consultants – and in no way replaces the services of the professional consultant and relevant engineers designing the project.

No liability can therefore be accepted by CSR or other parties for the use of this document. Hebel products and systems undergo constant research and development to integrate new technology and reflect ongoing performance enhancement.

Hebel systems are constantly reviewed so as to reflect any changes in legislative building requirements and or general developments in common building practice, due to our commitment to continual development and improving our building systems.

We advise that all users of this document should regularly check that this document is current, and they are applying our latest design information.

The latest editions of our documents are available on our website:

[www.hebel.co.nz](http://www.hebel.co.nz)

## The better way to build

Hebel is a quality building product, and is backed by CSR Building Products NZ Limited.

For more information visit our website:

[www.hebel.co.nz](http://www.hebel.co.nz)

For sales enquiries or further information, please telephone us from anywhere in New Zealand:

**0800 4 Hebel (0800 443 235)**

