

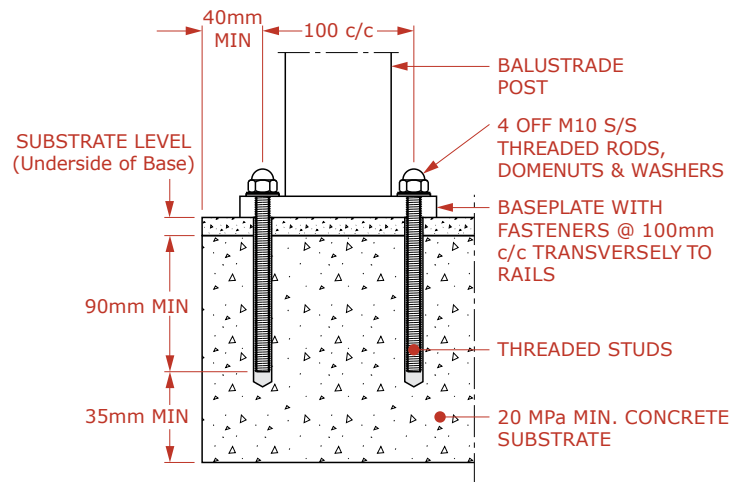

X1500, CONCRETE TOP FIXING, EPOXY-SET ANCHORS 100mm CRS, SPECIFICATION (EX-BA.01)F.33.31

This is a Standard Fixing Specification for the use of Extreme Barriers system, and must only be used in conjunction with the Specification Notes on page 38, and the relevant Style Specification on pages 14-19. Installation must be completed in accordance with the Installation Guide on pages 64-73.



THIS STANDARD SPECIFICATION IS COMPATIBLE WITH THE STYLE SPECIFICATION ON PAGES 14-19. REFER TO UNEX SYSTEMS FOR ALTERNATIVE STYLE SPECIFICATIONS AND NON-STANDARD FIXING METHODS.

NOTES RELATING TO THIS SPECIFICATION

- M10 threaded rods/studs are manufactured from 316 S/S and supplied by Unex Systems (M10 threaded rods are Unex code FE10-XXX where XXX is replaced by the length in mm of the rod e.g. FE10-120 is a 120mm M10 rod). Where a plaster finish, fascia, or other such element is positioned between the baseplate and the substrate, the length of the threaded rod needs to be increased by the same amount to maintain the specified embedment in the structural concrete.
- FE10-XXX studs as described above shall be installed and anchored into concrete using the Epoxy C6 system (Unex Code TEC) in accordance with the manufacturer's instructions.
- Substrate design including waterproofing and structural design of the concrete substrate and its reinforcing are not included in this specification and must be carried out by others.

Specifications subject to change without notice