



Thank you for your interest in the StyleLite® product range.

This document provides a comprehensive set of technical specifications for StyleLite, as well as answering common questions about machining, fabrication, installation and care.

For further enquiries visit www.mulfordplastics.co.nz or contact your nearest StyleLite distributor.

Contents

StyleLite Product Range	2
Edge Finishing	3
Hinge Recommendations	3
Important Warning	4
Things to Consider	4
Storage and Handling	4
Machining Guide	5
Forming / Bending Guide	5
Cleaning Do's and Don'ts	6
Scratch Repair - Gloss Only	6
StyleLite Sheet Lamination Guide	7
Environmental Statement	8
StyleLite Product Specifications	9,10

StyleLite Product Range

Product	Warranty Term
StyleLite Panels / StyleLite Sheet	10 years - domestic usage 5 years - caravan/RV usage 3 years - commercial usage

StyleLite decorative panels are designed as appearance products and are intended for use as drawer faces, cabinet doors, ends and general joinery cladding. The products are not intended for use as structural or built-in elements. If the products are used in structural or built-in applications, EGR's warranty liability is limited to replacement material only.

Introduction

All StyleLite panels feature StyleLite Sheet laminated front and back to a quality substrate. Our Product Range is divided into various applications, based on the best use of each substrate. StyleLite is available in two finish options – **TruGloss** or **TruMatte**.

Finish Options

TruGloss

Smooth, ultra High Gloss finish that provides a mirror-like appearance. Highly reflective.



TruMatte

Smooth, untextured matte finish, that provides increased scratch resistance over High Gloss surfaces and very low finger printing.

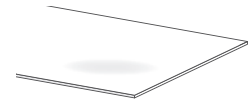

StyleLite Standard Panels

Regular StyleLite panels, suitable for a range of general purpose applications. Uses premium quality moisture-resistant MDF, rated to formaldehyde emissions standard E0 and TSCA TITLE VI. Perfect for kitchen and vanity doors and panels, furniture, hinged wardrobe doors, and general cabinetry.

Substrate	Finished Panel Size (nom)	Region	Weight	Finish
MR MDF E0	2440 × 1220 × 18mm	Global	13.5kg/m ²	TruGloss and TruMatte
MR MDF E0	3070 × 1230 × 18mm	Global	13.5kg/m ²	TruGloss and TruMatte
MR MDF TITLE VI	97" × 48.5" × ¾"	North America	2.76lb/ft ²	TruGloss and TruMatte
MR MDF TITLE VI	122" × 48.5" × ¾"	North America	2.76lb/ft ²	TruGloss and TruMatte

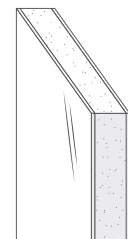

Other Substrates available on request. Optional White Textured Backing Sheet also available on all products.

StyleLite Lightweight Panels

Lightweight panels, perfect for when weight is a consideration. Uses high quality lightweight plywood. Great for interior fitout for caravans and RVs – from furniture and kitchen cabinetry, to vanity doors and panels.

Substrate	Finished Panel Size (nom)	Region	Weight	Finish
Lightweight Plywood	2440 × 1220 × 14mm	Global	7kg/m ²	TruGloss and TruMatte
Lightweight Plywood	2440 × 1220 × 17mm	Global	8kg/m ²	TruGloss and TruMatte

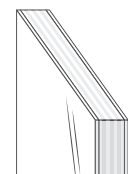

Optional White Textured Backing Sheet also available.

StyleLite Sheet

StyleLite Sheet is manufactured from high quality acrylic-capped ABS, and features reverse-side treatment for superior bonding performance. StyleLite Sheet is sold for high and low volume lamination – it is provided ready for manual or machine lamination onto a variety of substrates.

Product	Sheet Size	Region	Weight	Finish
StyleLite Sheet	2465 × 1230 × 1mm (97" × 48.5" × ⅜")	Global	1.08kg/m ²	TruGloss
StyleLite Sheet	3070 × 1230 × 1mm (123" × 48.5" × ⅜")	Global	1.08kg/m ²	TruGloss
StyleLite Sheet	2465 × 1230 × 0.8mm (97" × 48.5" × ⅛")	Global	0.86kg/m ²	TruMatte
StyleLite Sheet	3070 × 1230 × 0.8mm (123" × 48.5" × ⅛")	Global	0.86kg/m ²	TruMatte

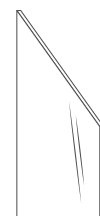

Edge Finishing

Color matched Edge Band rolls are available for StyleLite TruGloss and TruMatte Panel products.

EGR has partnered with a variety of global edge finishing specialists to create an extensive range. All StyleLite compatible Edge Band is of premium quality and offer high resistance to heat, abrasion, impact and color fade.

Standard Edge Band

Color-matched Standard Edge Band is pre-primed ready for installation using EVA hot melt or PUR edge banding machinery.

Type	Dimensions
Standard Edge Band for TruGloss or TruMatte Panels	23mm × 1mm (100m roll)

Fusion Heat Activated Edge Band

Fusion Edge Band allows a seamless color matched functional layer to bond to the board using hot air or laser equipped machinery. Fusion Edge Band is available in selected colors only.

Type	Dimensions
Fusion Edge Band for TruGloss or TruMatte Panels	23mm × 1.2mm (100m roll)

	<p>Warning</p> <p>Do not use PVC edge banding, solvent based adhesives or aggressive solvent based cleaners including "ABS Cleaner" at any time.</p>
---	---

Edge Band Technical Notes

Best results will be achieved using the following practices:

- CNC machining the panel edge or using an edge bander with pre-milling function.
- Leave protective film on panel in place at all times.
- Set trimming and scrapers to flush with surface of the StyleLite face, do not leave a lip.
- If there is glue overrun on the face, it can be removed using a microfibre cloth dampened with mineral turpentine (mineral spirits), use sparingly and avoid excessive rubbing.
- If manual scraping or finishing is required, take care to avoid gouging the face of the panel.

EVA Hot Melt Adhesive

- Use white adhesive on white panels and transparent on dark panels.

PUR Polyurethane Adhesive

- Suitable for all colors and will deliver a highly moisture resistant panel.

Hinge Recommendations

When using StyleLite panels for door installations, ensure the appropriate amount of hinges are used to deliver a professional result.

Door Height		Number of Hinges
Up to 800mm	[Up to 31"]	2 hinges
800 to 1300mm	[31" to 51"]	3 hinges
1300 to 1800mm	[51" to 70"]	4 hinges
1800 to 2100mm	[51" to 82"]	5 hinges
2100 to 2440mm	[82" to 97"]	6 hinges

- ▶ Always test hinge boring tools to ensure a clean cut is achieved.
- ▶ Best results will be achieved by drilling or boring through a thin MDF sacrificial block.
- ▶ Only bore the required depth amount of your hinge hardware.



Warning

**DO NOT REMOVE
PROTECTIVE FILM UNTIL
FINAL INSTALLATION
IS COMPLETE**

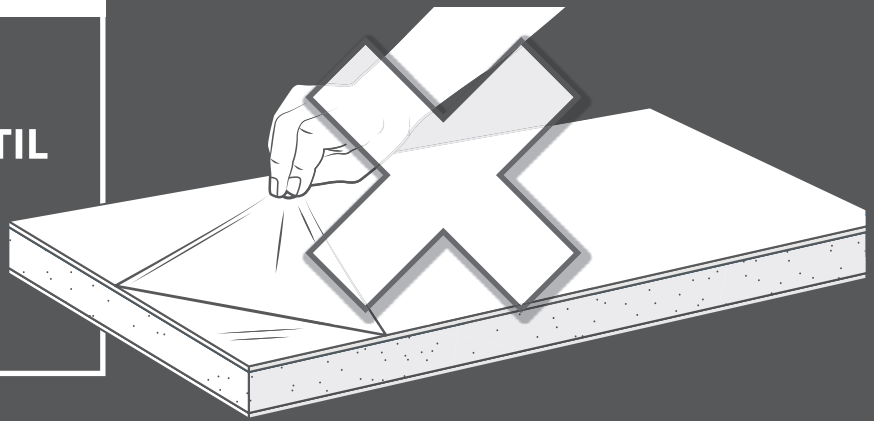

Things to Consider

- ▶ Adequate fixing should be provided at no greater than 400mm [15"] centres.
- ▶ We recommend an air gap of 6mm [$\frac{1}{4}$ "] adjacent to ovens and other heat sources.
- ▶ Do not over tighten handles as it may cause an unsightly dip in the High Gloss surface.
- ▶ StyleLite achieves maximum hardness a few days after the removal of the protective film. This process can be accelerated with a light polish.
- ▶ Metallic colors are directional. Take note of the arrows on the protective film. All metallic panels should be assembled/installed with the arrows in one direction to avoid apparent shade or color variation.
- ▶ **TruGloss sheets and panels are repairable.**
- ▶ **TruMatte sheets and panels are NOT repairable.**

Storage and Handling

StyleLite finished panels can be stored horizontally or vertically but should be well supported at all times.

- ▶ Do not store panels outside.
- ▶ Do not store or transport panels in direct sunlight.
- ▶ Avoid sliding the panels on the outer face surface.
- ▶ It is recommended that the panels are stored horizontally and supported at no more than 700mm [28"] from centres and 200mm [8"] from the ends to prevent the risk of warpage. All bearers should be of equal thickness and quality.
- ▶ Panels should be stored in well-ventilated and dry conditions.
- ▶ Cover boards should be placed on the top and bottom of stacked panels to provide protection and reduce the effects of environmental changes.

CORRECT STORAGE METHOD

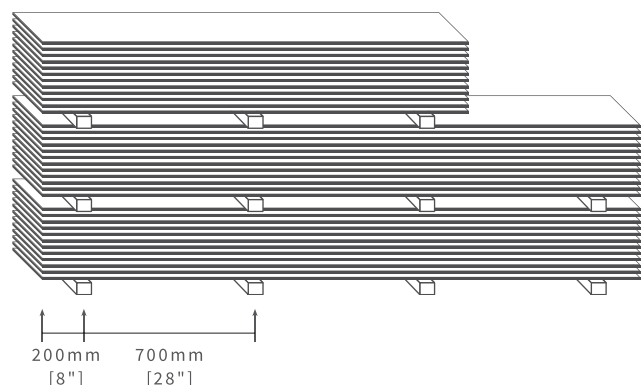

Machining Guide

Routering

Router cutting is the preferred method for cutting a StyleLite panel.

- ▶ Router cut using a feed rate of 10 to 15 metres per minute with a spindle speed of 20,000rpm.
- ▶ Solid carbide router cutters will deliver the best finish.
- ▶ Twin flute compression cutters are ideal as they minimise the chance of chipping at the edge and eliminate any feathering of the masking material on either side of the sheet.

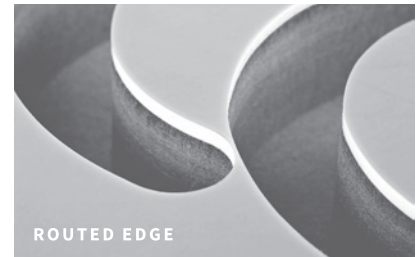

Saw Cutting

- ▶ Use very sharp carbide tipped blades with 3 to 5 teeth per centimetre.
- ▶ We recommend using a 300mm diameter blade at a speed of 3200rpm for best results. Results may vary depending on your equipment.

Band saw

Band saws can be used to cut curves however a secondary finishing operation will be required.

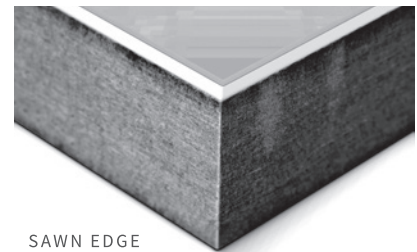

Drilling

- ▶ Drilling can be done using high speed steel or carbide tipped drills.
- ▶ Best results will be achieved using drills with a tip angle of 110 to 130°.
- ▶ Use slow to medium speeds to avoid overheating the material.

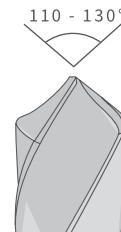

DRILL BIT 110 - 130°

Forming / Bending Guide

StyleLite sheet is co extruded using Acrylic and ABS layers which are both thermoplastics and the sheet is able to be formed to various angles using a combination of moderate heat and light pressure.

The first step in the process is to remove the substrate material to the desired shape of the bend and expose the reverse side of the StyleLite sheet. Typically 2 mm or 1/16" would be sufficient for most bends.

The heating should be applied to the face side of the StyleLite sheet using a well controlled element. The heating method should be set at a temperature that will heat the through the Stylelite sheet thickness to an adequate forming temperature of around 140° C or 280° F in 20 to 30 second time frame.

An element temperature of 370° C or 700° F has proven to be effective.

The adhesive can be applied to the MDF contact points of the joint before or after heating. Avoid the adhesive coming into contact with the formed area of the StyleLite sheet.

The bend can be made after heating and the panel should then be placed in a suitable jig or clamping method to cool and for the bonding adhesive to cure.

The StyleLite masking material or spot stick can be left in place throughout the machining, heating, bending and cooling process.

Forming / Bending Guide Precautions

- Insufficient heating and forcing the bend process will be likely to result in residual stress in the material which could result in cracking or crazing over time.
- Do Not expose formed parts to strong chemicals such as solvents or aggressive cleaners.
- Overheating may result in small bubbles or some rippling on the surface of the bend.
- The heaters should be positioned in such a way that only the area to be formed is exposed to the heat.
- The contact areas of the heating device should not exceed 75 deg C or 170 deg F or the face appearance of the StyleLite panel may be effected.

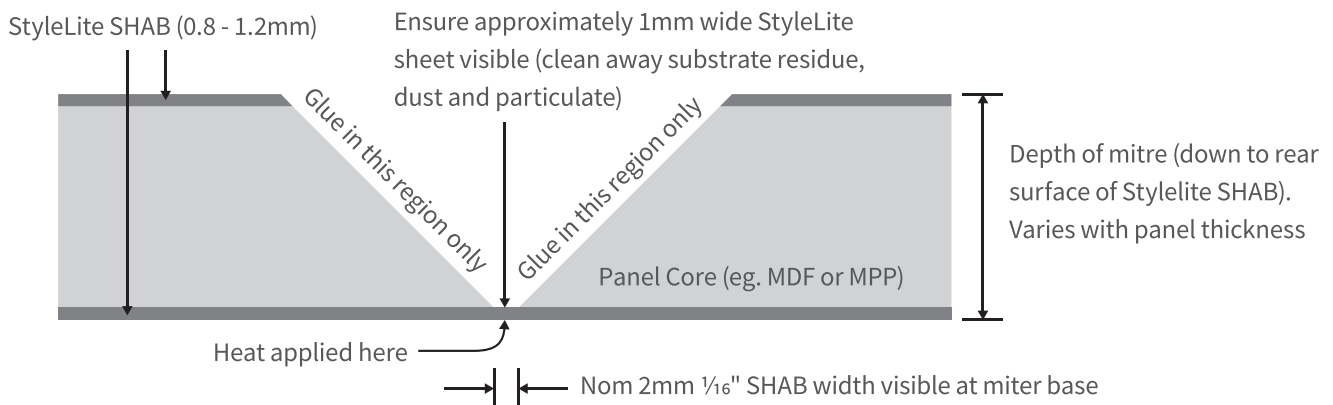

DIAGRAM: STYLELITE MITRED COMPONENT READY FOR HEAT BENDING

Cleaning Do's and Don'ts

StyleLite products can be cleaned simply using a wet microfibre cloth or chamois with non-abrasive soap. Diluted dish-washing liquid is an ideal cleaner.

Do Use	Don't Use
✓ Clean wet microfibre cloth	✗ Paper towel
✓ Clean wet chamois	✗ Dry wipe at any time
✓ Novus No. 1 polish used often	✗ Brushes, scourers or scrapers
✓ Non abrasive soap and detergent	✗ Abrasive cleaners
✓ Warm water	✗ Thinners or Methylated Spirits

Scratch Repair - Gloss Only

The StyleLite surface becomes more scratch resistant over the first few days after the removal of the protective film.

This process can be accelerated by lightly polishing the StyleLite surface immediately after the masking film is removed using Novus® No. 1 or Plexus® plastic polishes with a clean microfibre cloth.

Scratch Repair - Gloss Only Continued

 Please Note	<p>The repair advice below applies only to StyleLite TruGloss products.</p> <p>TruMatte cannot be repaired.</p>
---	---

Removing Marks and Light Scratches - Gloss Only

Apply Novus® No. 2 or a good quality liquid polish (e.g. 3M™ Finesse-It™ II, Kitten® Polishing Wax) and using a damp, clean microfibre or soft cloth, polish in a circular pattern. Then remove polish using General Cleaning procedure above.

Removing Heavier Scratches - Gloss Only

Apply Novus® No. 3 or a good quality fine compound polish (e.g. 3M™ Perfect-It™ III) and using a damp, clean microfibre or soft cloth, polish in back and forth motion at right angles to visible scratches. Then use Removing Marks and Light Scratches procedure.

Ensure all polish residues are removed completely from the StyleLite surface. Low speed electric buffing can also be used to repair marks and scratches on gloss sheet and panels.

StyleLite Sheet Lamination Guide

StyleLite Sheet is an acrylic-capped ABS decorative sheet suitable for lamination onto a variety of substrates.

Lamination Materials and Process

StyleLite – automated and manual lamination.

Substrate – use select grade smooth sanded moisture-resistant MDF. A 240 grit sanded finish will provide the best finish results.

Backing panel – for single sided applications using unfinished MDF, adhere 0.8mm thick cabinet liner, or 0.8mm backing HIPS or ABS liner to rear surface of the substrate.

Hand Lamination – Cross linked EVA, liquid PUR'S and water based contacts are suitable. Apply with a roller or notched trowel to achieve even spread of adhesive.

Automated Lamination – PUR reactive hotmelt and cross linked EVA systems are suitable. Using an even and light to moderate adhesive build, will achieve the optimum visual appearance and we recommend a steel pressing roller for best results.

Pressing – Ensure StyleLite and substrate are clean and free of dirt and debris before lamination. Light to moderate cold press only. Hot pressing StyleLite may induce excessive bow in the finished panel. Block stack for 24 hours after pressing.

Curved Panels – StyleLite laminated panels can be formed into curves by curving the rear of the substrate, or curve the substrate first and then bond StyleLite to the substrate using a water based contact adhesive.

Lamination should only be completed from 15°C to 30°C ambient temperature. StyleLite, MDF and the liner should be stored under the same conditions to equalise for at least 12 hours prior to lamination.

Doors and Panels

StyleLite laminated to MDF is designed for interior vertical non structural applications only. A maximum finished panel size of 3070mm x 1230mm is recommended.

Please Note

StyleLite laminated panels must always be suitably balanced on the reverse side of the substrate. Substrates can include MDF, HDF, Plywood or composite boards

Environmental Statement

StyleLite is a co-extruded, semi-rigid thermoplastic polymer sheet, which is intended as a lamination material suitable for bonding to a wide variety of substrates.

StyleLite consists of an ABS (acrylonitrile butadiene styrene) colored layer, which is permanently fused with a clear ultra high gloss Acrylic (Poly Methyl Methacrylate) top layer. StyleLite polymer sheet is an inert material and does not release any emissions to the environment during manufacture or in use. StyleLite is hygienic and does not promote bacterial growth or transmission.

All the color pigments used in StyleLite sheet do not contain heavy metals such as lead or cadmium.

StyleLite offers significant environmental advantages compared with other high gloss and matte finishes. StyleLite manufacture produces no VOCs unlike two pack spray paint, and StyleLite can be recycled.

StyleLite recommended lamination adhesive systems include water based EVAs and PUR reactive hot melts. Neither system emits any volatiles during the lamination process or during the life of the finished board products.

StyleLite polymer sheet can be treated as ABS for recycling purposes and falls under the Styrene group of polymers. StyleLite can be removed from the substrate by passive immersion in water. StyleLite sheet can then be recycled using mechanical means by grinding and pelletising for reuse in a multitude of extruded or injection moulded products.

The StyleLite sheet material recycling process only consumes around 15% of the original energy consumption required to manufacture the initial sheet material.

StyleLite can be cleaned and maintained using warm soapy water, and does not require the use of harsh or volatile chemicals. StyleLite can be refinished in situ many times and will remain functional for many years.

StyleLite is wholly manufactured under the EGR Environmental Management System, which has been independently accredited to ISO 14001.



StyleLite® Product Specifications

1/2

StyleLite laminated board complies with AS/NZS 4386.1 Domestic Kitchen Assemblies for Appearance, Flatness, Wood Substrate and the Adhesive Bonding System.

StyleLite Sheet Properties

Properties	Specification – TruGloss Sheet	Specification – TruMatte Sheet	Test Method
Specific Gravity	1:09	1:09	ASTM D792
Water Absorption	<0.5%	<0.5%	ASTM D570
Surface Hardness	3H - 4H	6 - 7H	Pencil Hardness
Heat Distortion Temperature	85°C [185°F]	85° C [185° F]	ASTM D648
Service Temperature	77°C [170.8°F]	77° C [170.8° F]	Continuous
Burning Resistance	94HB	94HB	UL 94
Gloss Level	90GU	<5GU	Viewed at 60°
Thickness	1.0mm ± 0.1mm	0.8mm ± 0.1mm	
Mass	1.08kg/m ² [0.22 lbs/f2]	0.86kg/m ² [0.1816 lbs/f2]	n/a
Surface Energy Rear	50	50	Dyne
Bond Strength	100N (25 Nm)	100N (25 Nm)	AS/ NZS 4266.28
Surface Soundness	1.25 MPa (0.9 MPa min)	1.25 MPa (0.9 MPa min)	AS/NZS 4266.7
Stain Resistance	No effect	No effect	AS/NZS 4266.25
Steam Resistance	No change after 30 minutes	No change after 30 minutes	AS/NZS 4266.23
Cracking Resistance	No effect	No effect	AS/NZS4266.24
Dry Heat Resistance	No loss of gloss or color change	No loss of gloss or color change	AS/NZS 4266.26
Colour	dE<1.0 for Solid Colours dE<1.5 for Metallic Colours		
Erichsen Hardness**	≥0.5N	≥0.7N	ISO 4586-2 (DIN EN 438-2)

Textured Backing Sheet Properties

Properties	Specification – Textured Backing Sheet	Test method
Specific Gravity	1.09	ASTM D-792
Water Absorption	<0.5	ASTM D-570
Colour**	dE<1.5 for Solid Colours	AS / NZS 1580.600
Erichsen Hardness**	≥0.2N	ISO 4586-2 (DIN EN 438-2)
HDT 264 PSI, 1.82MPa	96°C (203°F)	ASTM D-648
Service temperature	77°C (170°F)	
Thickness	0.8mm ± 0.1mm	
Surface Energy Rear	50	Dyne
Bond Strength	100N (25 Nm)	AS/ NZS 4266.28

** Internally tested by EGR

StyleLite® Product Specifications

2/2

StyleLite laminated board complies with AS/NZS 4386.1 Domestic Kitchen Assemblies for Appearance, Flatness, Wood Substrate and the Adhesive Bonding System.

StyleLite Panel Properties

Properties	Specification	Test Method
Panel Length	-2 +10mm	Steel tape
Panel Width	-2 +5m	Steel tape
Panel Diagonal	< 3mm	Steel tape
Panel Thickness	+/- 0.5mm	Micrometer
Panel Mass	+/- 5.0%	Calibrated scale
Panel Edges	Face material +/- 2mm from the finished edge of the MDF core. Face and core edges must be parallel to +/- 1mm over the length of the edge.	Steel rule
Useable Surface	The useable surface of the panel will meet or exceed the program size offered.	Steel rule
Face Bonding	>90% fibre split	Cleavage peel
Flatness	< 2.5mm/1000mm in any direction	Steel tape
Solid Colors	Delta E 1.0 reflected	TS - 075
Metallic Colors	Delta E 1.5 reflected	TS - 075
Woodgrains	Visual match to master	Controlled master
Surface quality for panel face area up to 3.5m ² <small>Specks, dimples or raised sections will not be grouped closer than 100mm</small>	6 Specks <0.5mm; 6 dimples or raised section <3mm; No obvious die or flow lines; No scratches or repeat marks; No pin holes >0.2mm	Visual assessment in moderate interior lighting Board viewed in a vertical condition from a distance of 1000mm.
Surface quality for board back surface	No obvious die or flow lines; No scratches; No repeat marks	As above
Masking	No wrinkles or lifting at the edges, sound adhesion across the face area	Visual
Packaging	Suitable cover board top and bottom with four bearers and heavy duty PE straps. Cell air between each sheet, corner protection fitted and pack fully PE wrapped.	Work instruction
Batch Traceability	Face side masking printed with date of lamination	Process control plan

Metallic and woodgrains can vary in color from batch to batch and individual end use projects should be manufactured from the same batch.

DISTRIBUTED BY



AUCKLAND NORTH +64 9 442 4051 | 123 Diana Drive, Wairau Valley, Auckland 0627

AUCKLAND SOUTH +64 9 573 0145 | 5 Arthur Brown Place, Mt Wellington, Auckland 1060, New Zealand

HAMILTON +64 7 850 4900 | 22B Sunshine Avenue, Te Rapa, Hamilton 3200, New Zealand

CHRISTCHURCH +64 3 365 7557 | 93 Buchan Street, Sydenham, Christchurch 8023, New Zealand

WELLINGTON +64 4 589 0221 | 166 Gracefield Road, Lower Hutt, Wellington 5010, New Zealand

DUNEDIN +64 3 365 7557 | 33 McBride Street South, Dunedin, 9012, New Zealand

mulfordplastics.co.nz