



H1 PRODUCT UPDATE







MAXRAFT IS READY FOR THE NEW BUILDING CODE

MBIE has announced changes to the building code, to make New Zealand buildings warmer, drier, healthier and more energy efficient. This includes increases to the minimum insulation level for floors, walls, windows and roofs for new housing.

NZ owned and operated, MAXRaft specialises in fully insulated concrete foundation products. MAXRaft products deliver excellent thermal performance and energy efficiency for a range of projects from the foundation up – from schools, hospitals and retirement villages, to social housing developments and stand-alone residential homes.

MAXRaft offer products designed to suit different ground conditions. All MAXRaft products feature pre-cut polystyrene components which are manufactured off-site. All MAXRaft products are supplied with a panel plan to maximise on-site efficiency and minimise waste. Each component contains up to 15% recycled material and can be recycled at end of life.

MAXRaft products are suitable for Homestar and Passive House designs and have exceeded the building code requirements for over ten years, making them a reliable solution for easily meeting compliance and significantly reducing heat loss through the foundation.

The R-values achieved with MAXRaft products are dependent on project-specific design and area to perimeter ratio. All MAXRaft products can also work in conjunction with Underfloor Heating where a minimum of R3* is required.

This guide will outline the suitable MAXRaft products for the new requirements.

*See underfloor heating information

CONTENTS

H1 Compliance	4
Zone Map	5
PRODUCTS	7
MAXSlab	8
MAXRaft	10
MAXRaft Plus+	12
MAX85	14
MAXRaft with Under Floor Heating	16
Sustainability and Recycling	17
Further Information	18
Summary R-Value Table	19

COMPLIANCE H1 INFORMATION

The new standards are set depending on building type. All residential (including apartments and wharenui) and other buildings under 300m² of lettable area refer to Table 1. For any non-residential buildings under 300m² that are not industrial warehouse or hangers, the new standards are reflected in Table 2.

H1/AS1 For all Residential and commercial buildings under 300m²

Table 2.1.2.2B: Minimum construction R-values for building elements that do not contain embedded heating systems
Paragraphs 2.1.2.2 b), 2.1.3.1







Construction R-values (m ² K/W) ⁽¹⁾						
Building element	Climate Zone 1	Climate Zone 2	Climate Zone 3	Climate Zone 4	Climate Zone 5	Climate Zone 6
Roof ⁽²⁾	R6.6	R6.6	R6.6	R6.6	R6.6	R6.6
Wall	R2.0	R2.0	R2.0	R2.0	R2.0	R2.0
Floor slab-on-ground floors	R1.5	R1.5	R1.5	R1.5	R1.6	R1.7
Floors other than slab-on-ground floors	R2.5	R2.5	R2.5	R2.8	R3.0	R3.0
Windows and doors ⁽³⁾	R0.46 ⁽³⁾	R0.46 ⁽³⁾	R0.46	R0.46	R0.50	R0.50
Skylights	R0.46	R0.46	R0.54	R0.54	R0.60	R0.60

H1/AS2 For all Non-Residential buildings with over 300m² lettable floor area

Table 2.1.2.2B: Minimum construction R-values for building elements that do not contain embedded heating systems
Paragraphs 2.1.2.2 b), 2.1.3.1

Construction R-values (m ² K/W) ⁽¹⁾						
Building element	Climate Zone 1	Climate Zone 2	Climate Zone 3	Climate Zone 4	Climate Zone 5	Climate Zone 6
Roof ⁽²⁾	R3.5	R4.0	R5.0	R5.4	R6.0	R7.0
Wall	R2.2	R2.4	R2.7	R3.0	R3.0	R3.2
Floor	R2.2	R2.2	R2.2	R2.4	R2.5	R2.6
Windows and doors	R0.33	R0.33	R0.37	R0.37	R0.40	R0.42
Skylights	R0.42	R0.42	R0.46	R0.46	R0.49	R0.51

CLIMATE ZONE MAP

		Heated	Unheated
Climate zone 1		2.5	1.5
Climate zone 2		2.5	1.5
Climate zone 3		2.5	1.5
Climate zone 4		2.8	1.5
Climate zone 5		3.0	1.6
Climate zone 6		3.0	1.7

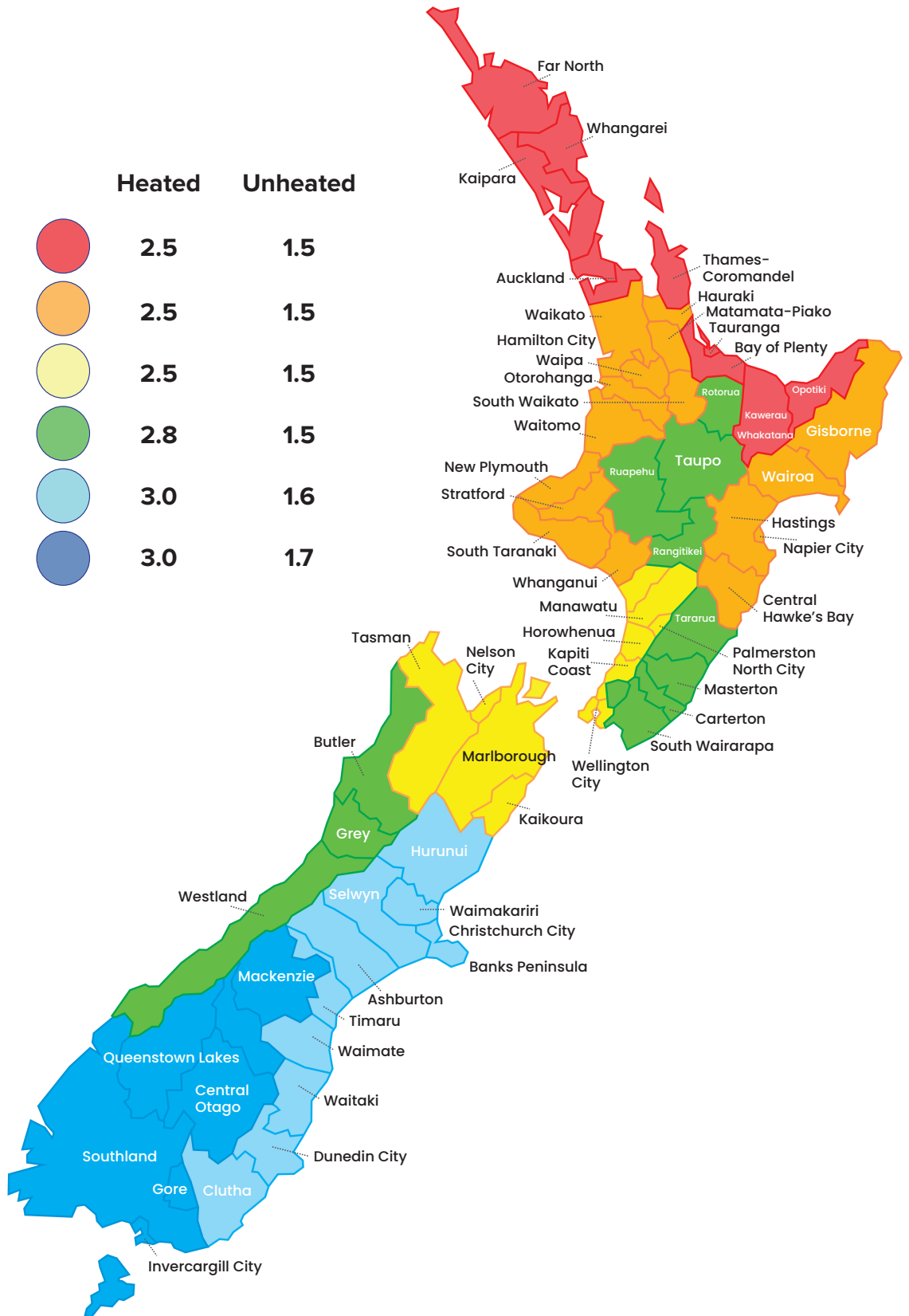



PRODUCTS

MAXRaft offers three fully insulated foundation products to meet different ground conditions and insulation requirements.

Each product can include:

1. **MAXRaft** L Shape profiles which reduce heat loss from the perimeter.
2. **VH EPS** Load bearing thickenings or ribs
3. **Polystyrene infill or pods** (The grade of EPS differs depending on product)

MAXRaft is BRANZ appraised.



PRODUCT INFORMATION

MAXSlab is designed for TC1/ good ground found in many places in New Zealand.

KEY FEATURES

- Superior R-values
- VH EPS perimeter & thickening insulation
- Solid sheets of insulation under slab (no ribs)
- Suitable with 90mm/140mm/SIPS
- Suitable with UF Heating
- Panel plan and pre-cut materials
- Minimum waste / Recycled polystyrene material
- Engineered design
- Suitable for sloping sites

DETAIL

VH EPS, VH Thickenings, S Grade sheets.

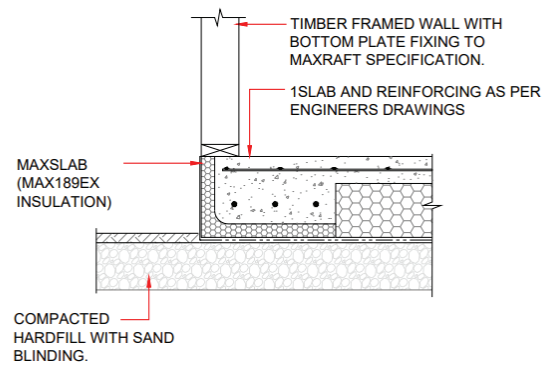
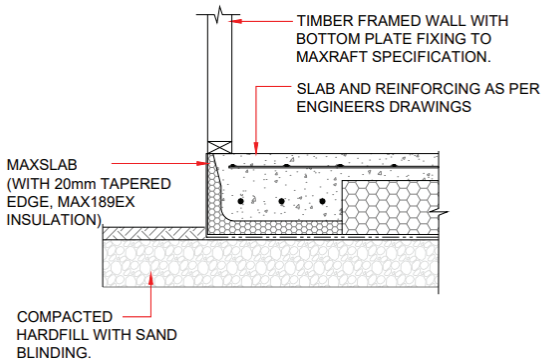

STANDARD HEIGHTS

300MM	350MM	400MM
--------------	--------------	--------------

Bespoke options available

R VALUE TABLE

	AREA / PERIMETER RATIO									
	1.6	1.8	2	2.2	2.4	2.6	2.8	3	3.6	4
MAXSlab 300	2.77	2.99	3.22	3.38	3.54	3.7	3.86	4.02	4.49	4.81
MAXSlab 350	2.96	3.25	3.53	3.69	3.85	4.01	4.17	4.33	4.87	5.23
MAXSlab 400	2.89	3.17	3.45	3.65	3.84	4.04	4.23	4.43	4.92	5.25
MAXSlab 300 Brick* Rebate	2.27	2.48	2.68	2.83	2.99	3.14	3.29	3.44	3.95	4.29

*If brick cladding is to ground, please refer to the MAXSlab or MAXRaft R-Value details shown in above table. (Non-brick)



MAXRaft®

200KPA / TC2 / EXPANSIVE SOILS / PILES



PRODUCT INFORMATION

MAXRaft slabs are typically designed on soft ground, 200KPA / TC2 / Expansive soils / Piles

KEY FEATURES

- VH EPS perimeter & thickening insulation
- Easily meets the building code
- Suitable with 90mm/140mm/SIPS
- Panel plan and pre-cut materials including- PODS
- Minimum waste / Recycled polystyrene materials Engineered design

DETAIL

VH EPS Profile, VH EPS Ribs & Thickenings, standard eps waffle pods.

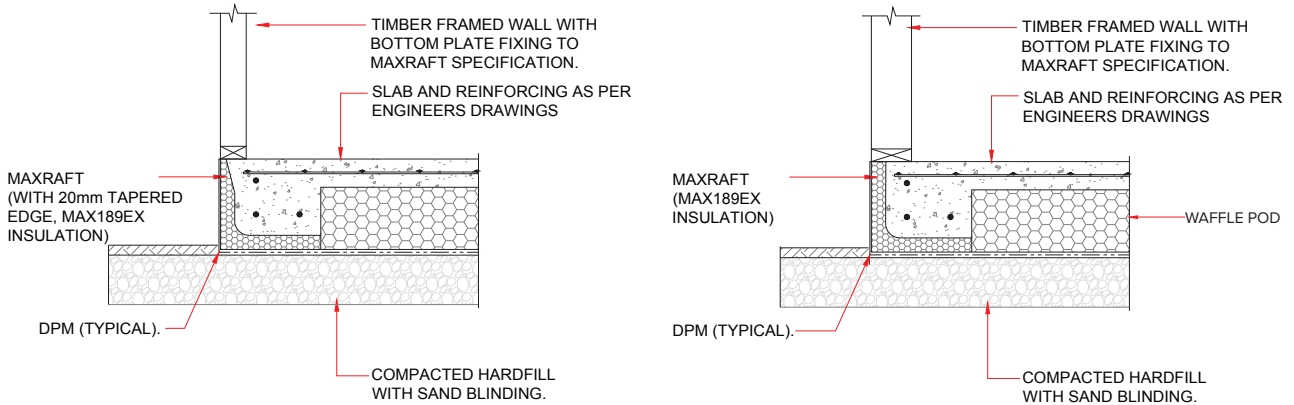

STANDARD HEIGHTS

320MM	340MM	400MM	420MM
--------------	--------------	--------------	--------------

Bespoke options available

R VALUE TABLE

	AREA / PERIMETER RATIO									
	1.6	1.8	2	2.2	2.4	2.6	2.8	3	3.6	4
MAXRaft 320	1.86	1.97	2.07	2.16	2.25	2.33	2.42	2.5	2.74	2.9
MAXRaft 400	1.68	1.81	1.93	2.01	2.1	2.18	2.27	2.35	2.59	2.74
MAXRaft 320 Brick*	1.62	1.73	1.85	1.93	2.02	2.11	2.2	2.29	2.53	2.69
MAXRaft 400 Brick*	1.56	1.68	1.79	1.87	1.96	2.05	2.14	2.23	2.46	2.62

*If brick cladding is to ground, please refer to the MAXSlab or MAXRaft R-Value details shown in above table. (Non-brick)



PRODUCT INFORMATION

MAXRaft Plus+ is designed to achieve better performance than a standard MAXRaft. It utilises solid PODS instead of typical waffle pods to achieve higher R-values. MAXRaft Plus+ is a great option where UF heating is specified on soft ground conditions.

KEY FEATURES

- Solid insulation throughout
- Easily meets the building code
- Suitable with 90mm/140mm/SIPS
- VH EPS perimeter & thickening insulation
- Panel plan and pre-cut materials including PODS
- Minimum waste / Recycled polystyrene materials
- 50/50 recycled pods or S grade solid pods

DETAIL

VH EPS Profile, VH EPS Ribs & Thickenings, standard eps Solid Pods.

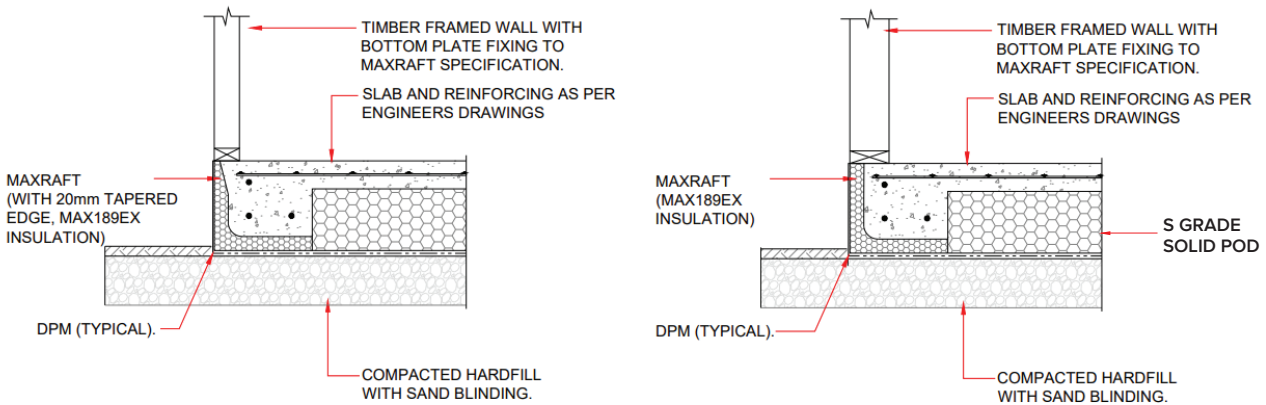

STANDARD HEIGHTS

320MM	340MM	400MM	420MM
-------	-------	-------	-------

Bespoke options available

R VALUE TABLE

	AREA / PERIMETER RATIO									
	1.6	1.8	2	2.2	2.4	2.6	2.8	3	3.6	4
MAXRaft Plus+ 320	2.38	2.54	2.7	2.86	3.02	3.18	3.35	3.51	3.81	4.02
MAXRaft Plus+ 400	2.44	2.62	2.81	2.97	3.13	3.29	3.46	3.62	3.95	4.17
MAXRaft Plus+ 320 Brick*	2.18	2.38	2.59	2.71	2.38	2.95	3.07	3.19	3.5	3.17
MAXRaft Plus+ 400 Brick*	2.11	2.29	2.47	2.6	2.73	2.86	2.99	3.12	3.57	3.87

*If brick cladding is to ground, please refer to the MAXSlab or MAXRaft R-Value details shown in above table. (Non-brick)



PRODUCT INFORMATION

MAX85 is designed to meet the minimum H1 building code requirements.

Unlike the MAXSlab or MAXRaft products, MAX85 does not have insulation in thickenings and ribs.

KEY FEATURES

- Includes MAXRaft patent VH EPS Perimeter
- Suitable for good ground/ soft ground / TC2/ expansive soils/ piles
- Suitable with 90mm/140/SIPS
- Panel plan and pre cut materials
- Engineered design
- 85mm concrete
- Suitable for sloping sites

*See Area/ perimeter table on right hand page.

DETAIL

VH EPS MAXRaft Perimeter, Standard waffle pods

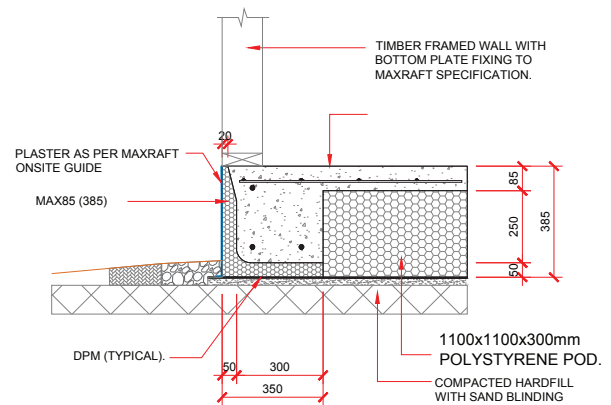
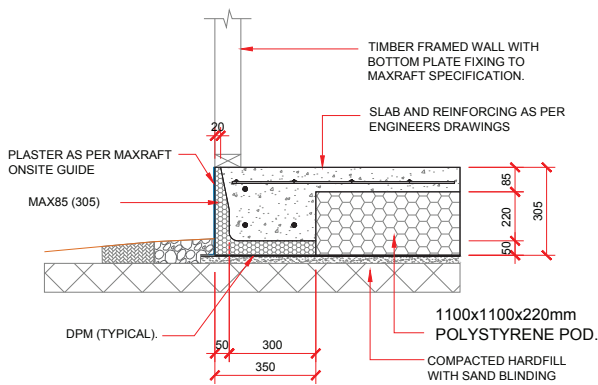

305MM	320MM	385MM	400MM
--------------	--------------	--------------	--------------

Bespoke options available

R VALUE TABLE

	AREA / PERIMETER RATIO									
	1.6	1.8	2	2.2	2.4	2.6	2.8	3	3.6	4
MAX85 305	1.46	1.54	1.62	1.7	1.77	1.85	1.92	2	2.21	2.36
MAX85 385	1.52	1.62	1.72	1.8	1.88	1.96	2.03	2.11	2.33	2.48
MAX85 305 Brick	1.3	1.39	1.47	1.55	1.62	1.7	1.78	1.85	2.06	2.21
MAX85 385 Brick	1.34	1.43	1.53	1.6	1.68	1.76	1.84	1.92	2.14	2.28



UNDERFLOOR HEATING

New H1 requirements by climate zone for embedded UF heating.

Constuction R-Values (M2/K/W)					
ZONE 1	ZONE 2	ZONE 3	ZONE 4	ZONE 5	ZONE 6
2.5	2.5	2.5	2.8	3.0	3.0

MAXRaft products and embedded in-slab heating are a great combination.

Good ground & UF Heating

In most instances MAXSlab will meet the R2.5 to R3 requirement based on climate zone.

Soft soils & UF Heating

MAXRaft insulation is upgraded to MAXRaft Plus+ to meet the R-value requirements when underfloor heating is specified.

	Area / Perimeter Ratio									
	1.6	1.8	2	2.2	2.4	2.6	2.8	3	3.6	4
MAXSlab 300	2.77	2.99	3.22	3.38	3.54	3.7	3.86	4.02	4.49	4.81
MAXSlab 350	2.96	3.25	3.53	3.69	3.85	4.01	4.17	4.33	4.87	5.23
MAXSlab 400	2.89	3.17	3.45	3.65	3.84	4.04	4.23	4.43	4.92	5.25
MAXRaft 320 MAXRaft Plus+	2.38	2.54	2.7	2.86	3.02	3.18	3.35	3.51	3.81	4.02
MAXRaft 400 MAXRaft Plus+	2.44	2.62	2.81	2.97	3.13	3.29	3.46	3.62	3.95	4.17

Notes:

- We can adapt our MAXRaft products if and where required – especially where sites have soft soils and low A/P ratio.
- Underfloor heating pipes can be laid on the mesh or on the polystyrene.
- Where the pipes are installed on top of the mesh, typically the slab thickness and the mesh grade will be increased.



FURTHER INFORMATION

Engineering

All MAXRaft Fully Insulated Foundations require an engineered design and PS1.

MAXRaft can complete the slab design in house by one of trusted teams or by your preferred engineer.

Plastering

The MAXRaft system exterior requires protection from physical damage, UV rays and water absorption.

MAXRaft should be protected by the use of a coating that protects the insulation and is suitable for use in the subgrade.

MAXRaft recommends plastering to be completed within 30 days of the pour.

Please contact your preferred applicator for more information.

SUMMARY R-VALUE TABLE

		AREA / PERIMETER RATIO									
	Product	1.6	1.8	2	2.2	2.4	2.6	2.8	3	3.6	4
1	MAXSlab 300	2.77	2.99	3.22	3.38	3.54	3.7	3.86	4.02	4.49	4.81
2	MAXSlab 350	2.96	3.25	3.53	3.69	3.85	4.01	4.17	4.33	4.87	5.23
3	MAXSlab 400	2.89	3.17	3.45	3.65	3.84	4.04	4.23	4.43	4.92	5.25
4	MAXSlab 300 Brick Rebate	2.27	2.48	2.68	2.83	2.99	3.14	3.29	3.44	3.95	4.29
5	MAXRaft 320	1.86	1.97	2.07	2.16	2.25	2.33	2.42	2.5	2.74	2.9
6	MAXRaft 400	1.68	1.81	1.93	2.01	2.1	2.18	2.27	2.35	2.59	2.74
7	MAXRaft 320 Brick	1.62	1.73	1.85	1.93	2.02	2.11	2.2	2.29	2.53	2.69
8	MAXRaft 400 Brick	1.56	1.68	1.79	1.87	1.96	2.05	2.14	2.23	2.46	2.62
9	MAX85 305	1.46	1.54	1.62	1.7	1.77	1.85	1.92	2	2.21	2.36
10	MAX85 385	1.52	1.62	1.72	1.8	1.88	1.96	2.03	2.11	2.33	2.48
11	MAX85 305 Brick	1.3	1.39	1.47	1.55	1.62	1.7	1.78	1.85	2.06	2.21
12	MAX85 385 Brick	1.34	1.43	1.53	1.6	1.68	1.76	1.84	1.92	2.14	2.28
13	MAXRaft Plus+ 320 (50/50 POD)	2.38	2.54	2.7	2.86	3.02	3.18	3.35	3.51	3.81	4.02
14	MAXRaft Plus+ 400 (50/50 POD)	2.44	2.62	2.81	2.97	3.13	3.29	3.46	3.62	3.95	4.17
15	MAXRaft Plus+ 320 Brick (SG POD)	2.5	2.67	2.84	3.01	3.19	3.36	3.53	3.7	4.03	4.25
16	MAXRaft Plus+ 400 Brick (SG POD)	2.54	2.74	2.94	3.11	3.28	3.45	3.63	3.8	4.15	4.38
17	MAXRaft Plus+ 320 Brick	2.18	2.38	2.59	2.71	2.38	2.95	3.07	3.19	3.5	3.17
18	MAXRaft Plus+ 400 Brick	2.11	2.29	2.47	2.6	2.73	2.86	2.99	3.12	3.57	3.87

Product	Suitability
MAXSlab	Good Ground, TC1, 300KPA
MAXRaft 320	200KPA, M Class soils
MAXRaft 400	TC2, H Class Soils
MAX85 305	TC1, 200KPA, M Class soils
MAX85 385	TC2, H Class Soils
MAXRaft Plus+320	200KPA, M Class soils
MAXRaft Plus+400	TC2, H Class Soils

NOTES

A series of horizontal dotted lines for writing notes.



For more information or to get a quote:

PHONE: 0800 MAXRaft

0800 629 7238

EMAIL: [Hello@maxraft.co.nz](mailto>Hello@maxraft.co.nz)

quotes@maxraft.co.nz

WWW.MAXRaft.CO.NZ