

AS74022-HSM

SURFACE MOUNTED DOUBLE TOILET ROLL DISPENSER WITH HOOD

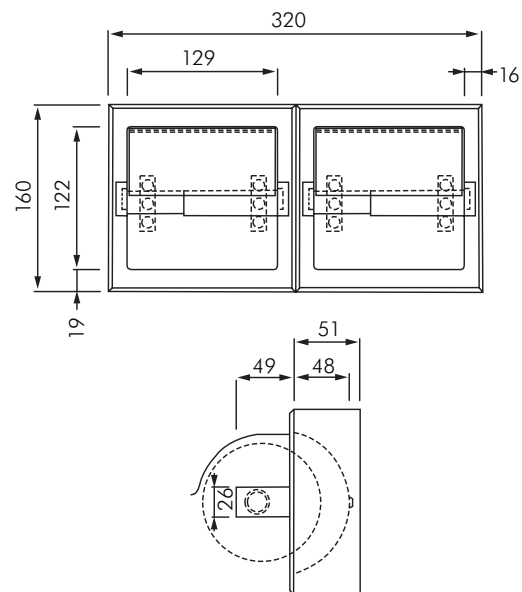
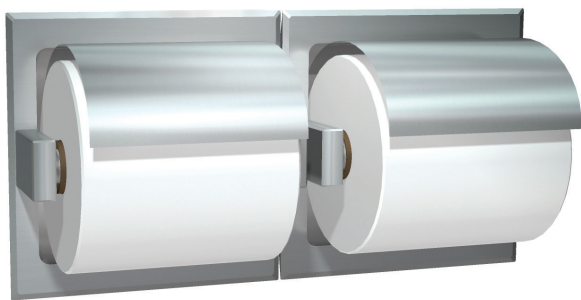

DESCRIPTION

AS74022-HSM is a double roll toilet paper dispenser for standard core roll toilet paper with hood and dispense all standard core roll toilet paper up to 150mm diameter. Fabricated of stainless steel type 304, all exposed surfaces are finished in either satin or bright finish. Standard roll holders are made from high impact ABS plastic finished with chrome plating. Hoods are attached with a full-length brass pivot rods.

The AS74022-HSM is ideal for all bathrooms and is especially suitable for accessible bathrooms. For a recessed version of this toilet roll holder, please see AS7402-H.

MODELS

AS74022-HSSM - Standard model as shown in satin stainless steel

AS74022-HBSM - Standard model as shown in bright stainless steel

For a theft-resistant spindle, add -R009 after your selected model code.



**MACDONALD
INDUSTRIES LIMITED**

Auckland (Head Office)

20 Carr Rd, Three Kings

Auckland 1041

P: 09 624 1115

F: 09 624 1110

E: sales@macdonaldindustries.co.nz

Wellington

P: 04 569 8033

F: 04 569 8066

Christchurch

P: 03 348 2356

F: 03 348 2376

www.macdonaldindustries.co.nz