



**HINGED DOOR, OPEN IN AND OUT
WITH OVERLIGHT TRANSOM**
CROSS SECTION

CAD REF. VHD07-0

DATE
01.04.19

SCALE
1:2

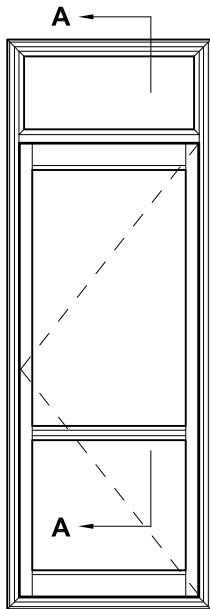
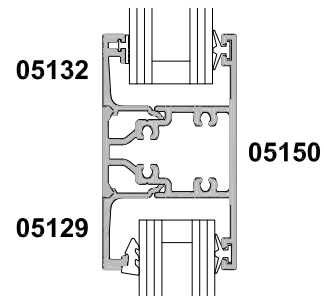
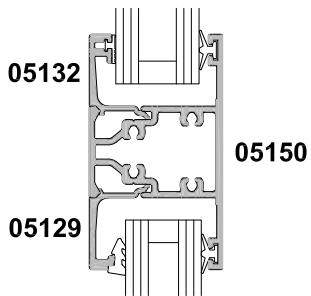
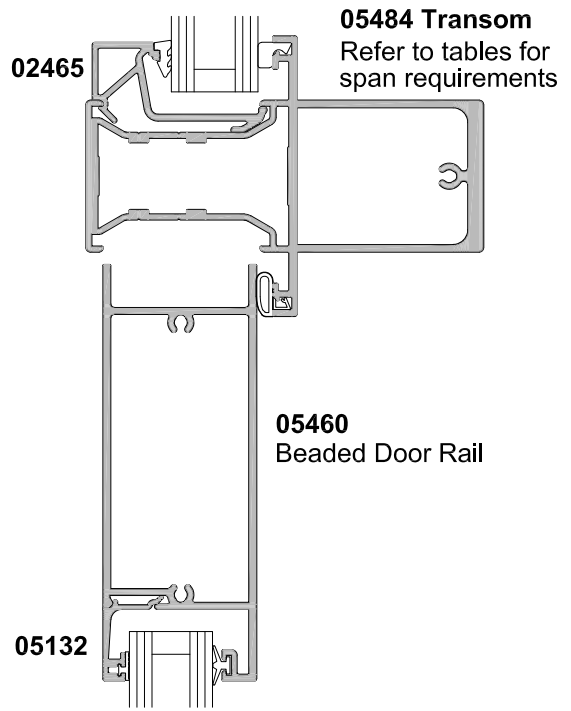
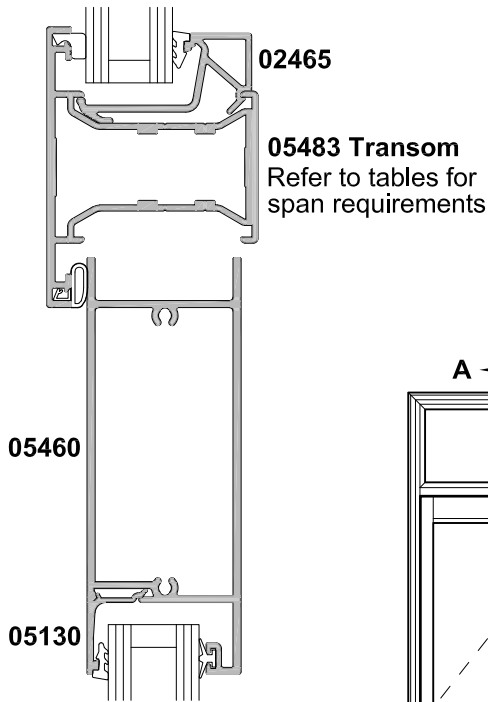
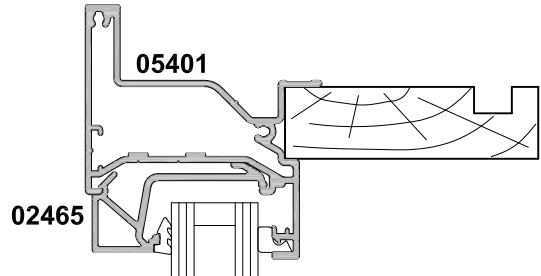
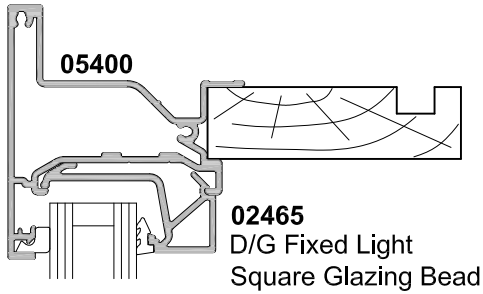

SECTION A-A
OPEN IN

SECTION A-A
OPEN OUT