



40MM WINDOW SERIES
SPAN TABLES

CAD REF. VC4015-0

DATE
01.06.11

SCALE
NTS

Extrusion: 08610
Description: Mullion

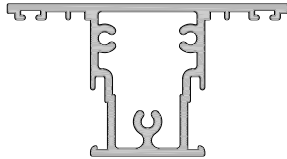
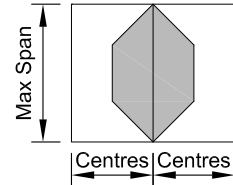

Centres	Spans for each wind zone			
	Low	Medium	High	Very High
1000	1768	1622	1458	1355
1100	1724	1584	1426	1327
1200	1687	1552	1399	1304
1300	1655	1523	1376	1287
1400	1626	1499	1363	1282
1500	1601	1481	1358	1277
1600	1582	1476	1353	1272
1700	1577	1471	1348	1267
1800	1572	1466	1343	1262
1900	1567	1461	1338	1257
2000	1562	1456	1333	1252

Extrusion: 08611
Description: Internal Box Mullion

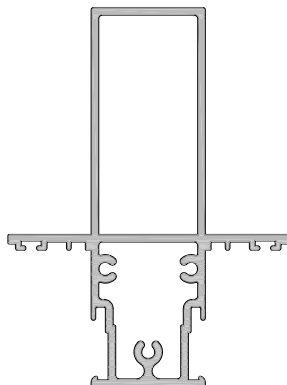
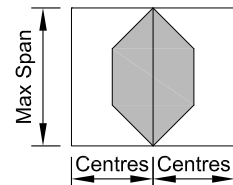

Centres	Spans for each wind zone			
	Low	Medium	High	Very High
1000	3219	2936	2615	2412
1100	3125	2852	2542	2346
1200	3043	2778	2477	2288
1300	2970	2712	2421	2237
1400	2905	2654	2370	2191
1500	2846	2602	2325	2151
1600	2793	2554	2284	2115
1700	2744	2511	2248	2082
1800	2700	2472	2214	2051
1900	2659	2436	2183	2024
2000	2622	2402	2154	1999

Extrusion: 08612
Description: Heavy Duty Internal Box Mullion

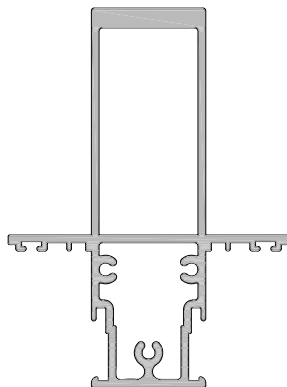
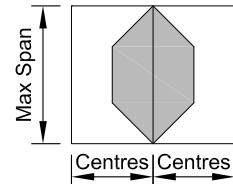

Centres	Spans for each wind zone			
	Low	Medium	High	Very High
1000	3549	3235	2879	2654
1100	3444	3141	2797	2580
1200	3352	3058	2725	2514
1300	3270	2985	2661	2456
1400	3197	2919	2604	2405
1500	3131	2860	2553	2359
1600	3071	2806	2507	2318
1700	3017	2758	2465	2280
1800	2967	2713	2426	2245
1900	2921	2672	2391	2214
2000	2878	2634	2358	2185

Spans are the maximum calculated allowable, based on NZS4211:2008, which requires that the member deflection at serviceability wind pressure (SWP) shall not exceed 1/200 of the span. Hardware and componentry may further restrict the spans.

For advice we recommend you contact APL Technical Advisory Service



40MM WINDOW SERIES
SPAN TABLES

CAD REF. VC4016-0

DATE
01.06.11

SCALE
NTS

Extrusion: 08614
Description: External 85mm Fin Mullion

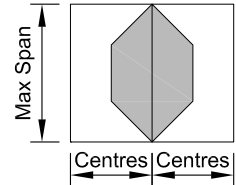
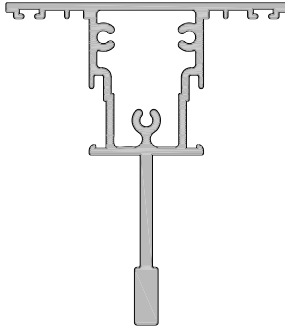

Centres	Spans for each wind zone			
	Low	Medium	High	Very High
1000	2915	2660	2273	2017
1100	2831	2574	2190	1949
1200	2758	2487	2123	1895
1300	2693	2414	2069	1854
1400	2635	2354	2026	1822
1500	2583	2305	1993	1800
1600	2537	2265	1968	1785
1700	2494	2234	1951	1778
1800	2455	2210	1940	1776
1900	2419	2192	1936	1771
2000	2386	2181	1935	1766

Extrusion: 08615
Description: External 100mm Fin Mullion

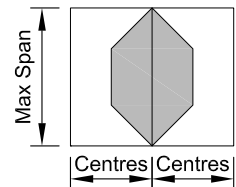
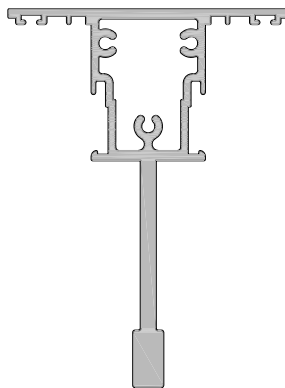

Centres	Spans for each wind zone			
	Low	Medium	High	Very High
1000	3557	3243	2878	2545
1100	3452	3148	2762	2447
1200	3360	3065	2665	2366
1300	3278	2991	2584	2300
1400	3205	2926	2516	2245
1500	3138	2866	2460	2201
1600	3078	2809	2413	2166
1700	3024	2754	2375	2139
1800	2973	2708	2344	2120
1900	2927	2670	2321	2106
2000	2885	2639	2304	2099

Spans are the maximum calculated allowable, based on NZS4211:2008, which requires that the member deflection at serviceability wind pressure (SWP) shall not exceed 1/200 of the span. Hardware and componentry may further restrict the spans. For advice we recommend you contact APL Technical Advisory Service



40MM WINDOW SERIES
SPAN TABLES

CAD REF. VC4017-0

DATE
01.06.11

SCALE
NTS

Extrusion: 08617/08619
Description: External Fin Chair and Cap

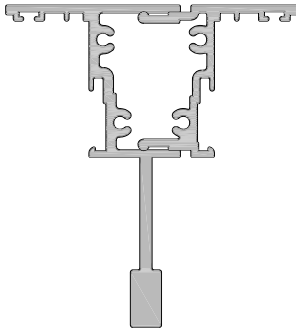
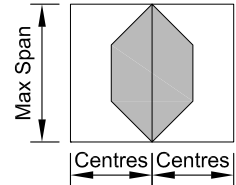

Centres	Spans for each wind zone			
	Low	Medium	High	Very High
1000	2917	2662	2373	2191
1100	2833	2587	2308	2132
1200	2760	2521	2251	2081
1300	2695	2463	2201	2036
1400	2637	2412	2157	1997
1500	2585	2366	2117	1961
1600	2538	2324	2082	1929
1700	2496	2286	2050	1901
1800	2457	2252	2020	1875
1900	2421	2220	1993	1860
2000	2388	2191	1975	1855

Extrusion: 08618/08619
Description: External Box Fin Chair and Cap

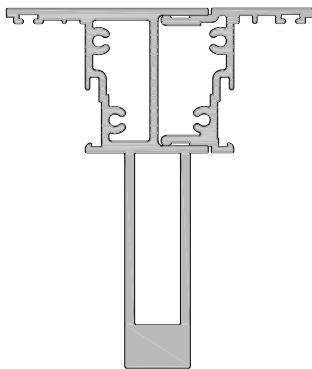
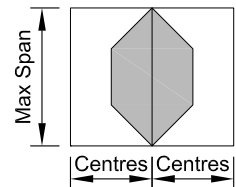

Centres	Spans for each wind zone			
	Low	Medium	High	Very High
1000	3902	3556	3163	2914
1100	3786	3451	3071	2831
1200	3683	3358	2990	2757
1300	3592	3276	2919	2692
1400	3511	3203	2855	2635
1500	3437	3137	2797	2583
1600	3370	3077	2745	2536
1700	3309	3022	2698	2493
1800	3253	2972	2655	2454
1900	3201	2926	2615	2418
2000	3153	2883	2578	2385

Extrusion: 08620/08619
Description: Internal Box Chair and Cap

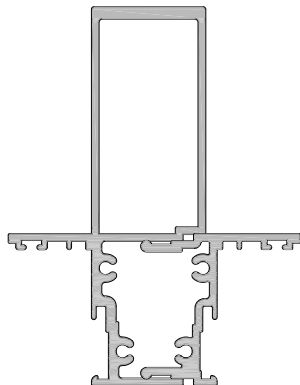
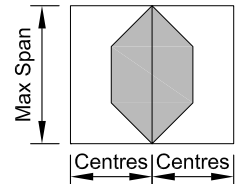

Centres	Spans for each wind zone			
	Low	Medium	High	Very High
1000	3223	2939	2618	2415
1100	3129	2855	2544	2348
1200	3046	2781	2480	2290
1300	2973	2715	2423	2239
1400	2908	2657	2373	2194
1500	2849	2604	2328	2153
1600	2796	2557	2287	2117
1700	2747	2514	2250	2084
1800	2703	2474	2216	2053
1900	2662	2438	2185	2026
2000	2624	2405	2157	2000

Spans are the maximum calculated allowable, based on NZS4211:2008, which requires that the member deflection at serviceability wind pressure (SWP) shall not exceed 1/200 of the span. Hardware and componentry may further restrict the spans.

For advice we recommend you contact APL Technical Advisory Service



40MM WINDOW SERIES
SPAN TABLES

CAD REF. VC4018-0

DATE
01.06.11

SCALE
NTS

Extrusion: 08622 / 08619
Description: Internal Box Chair and Cap

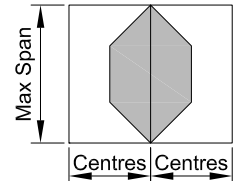
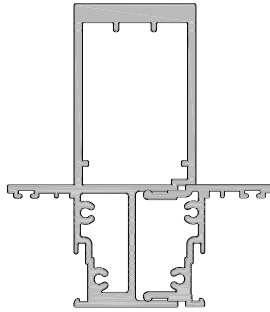

Centres	Spans for each wind zone			
	Low	Medium	High	Very High
1000	3889	3544	3153	2905
1100	3773	3439	3061	2821
1200	3671	3348	2981	2748
1300	3580	3266	2909	2684
1400	3499	3193	2846	2626
1500	3426	3127	2788	2575
1600	3359	3067	2737	2528
1700	3298	3013	2689	2485
1800	3242	2963	2646	2447
1900	3191	2917	2607	2411
2000	3143	2874	2570	2378

Extrusion: 08623/08619
Description: Internal Box Chair and Cap

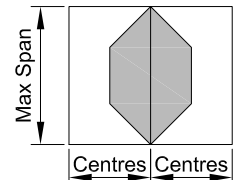
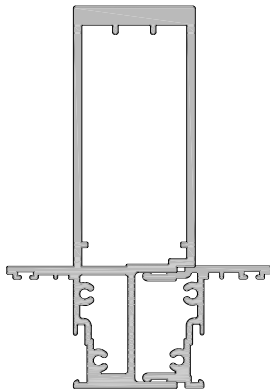

Centres	Spans for each wind zone			
	Low	Medium	High	Very High
1000	4801	4373	3886	3577
1100	4656	4241	3770	3472
1200	4528	4125	3668	3379
1300	4413	4022	3577	3296
1400	4310	3929	3496	3222
1500	4218	3845	3423	3156
1600	4133	3769	3356	3095
1700	4055	3699	3295	3040
1800	3984	3635	3240	2990
1900	3918	3576	3188	2943
2000	3857	3521	3141	2900

Extrusion: 08624/08619
Description: Internal Box Chair and Cap

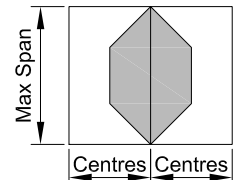
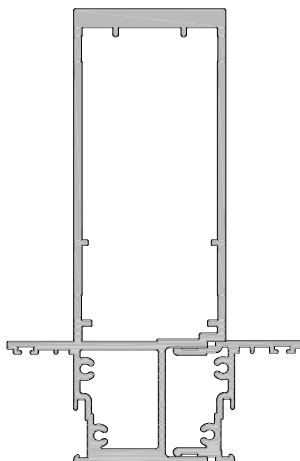

Centres	Spans for each wind zone			
	Low	Medium	High	Very High
1000	5878	5351	4752	4373
1100	5698	5188	4609	4241
1200	5539	5044	4482	4125
1300	5397	4916	4368	4022
1400	5270	4800	4267	3929
1500	5154	4696	4175	3845
1600	5049	4600	4091	3769
1700	4952	4513	4015	3699
1800	4863	4433	3944	3635
1900	4781	4358	3879	3576
2000	4704	4289	3819	3521

Spans are the maximum calculated allowable, based on NZS4211:2008, which requires that the member deflection at serviceability wind pressure (SWP) shall not exceed 1/200 of the span. Hardware and componentry may further restrict the spans. For advice we recommend you contact APL Technical Advisory Service



40MM WINDOW SERIES
SPAN TABLES

CAD REF. VC4019-0

DATE
01.06.11

SCALE
NTS

Extrusion: 08625
Description: Transom

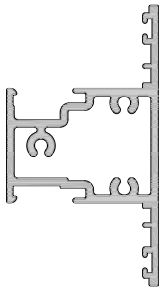
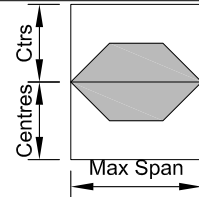

Centres	Spans for each wind zone			
	Low	Medium	High	Very High
1000	1744	1600	1439	1338
1100	1701	1563	1408	1311
1200	1665	1532	1382	1288
1300	1633	1504	1359	1274
1400	1605	1480	1349	1269
1500	1581	1466	1344	1264
1600	1566	1461	1339	1259
1700	1561	1456	1334	1254
1800	1556	1451	1329	1249
1900	1551	1446	1324	1244
2000	1546	1441	1319	1239

Extrusion: 08626
Description: External Fin Transom

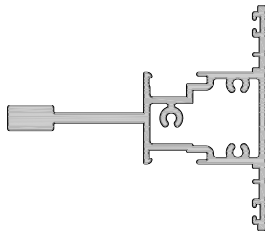
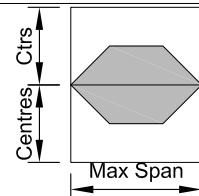

Centres	Spans for each wind zone			
	Low	Medium	High	Very High
1000	3041	2775	2473	2282
1100	2954	2696	2404	2219
1200	2876	2627	2344	2151
1300	2808	2566	2292	2095
1400	2747	2511	2245	2051
1500	2693	2463	2203	2017
1600	2643	2419	2165	1991
1700	2598	2379	2131	1972
1800	2557	2342	2100	1947
1900	2519	2309	2071	1922
2000	2484	2278	2045	1918

Extrusion: 08627
Description: Internal Box Transom

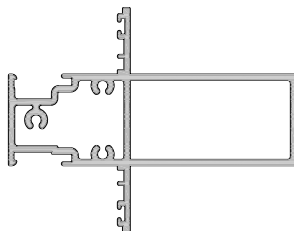
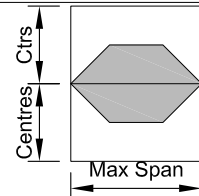

Centres	Spans for each wind zone			
	Low	Medium	High	Very High
1000	3064	2796	2491	2298
1100	2976	2716	2422	2233
1200	2898	2646	2361	2164
1300	2829	2585	2308	2107
1400	2768	2530	2261	2063
1500	2712	2481	2219	2027
1600	2662	2436	2181	2001
1700	2617	2396	2146	1982
1800	2575	2359	2115	1961
1900	2537	2325	2086	1935
2000	2502	2294	2059	1928

Spans are the maximum calculated allowable, based on NZS4211:2008, which requires that the member deflection at serviceability wind pressure (SWP) shall not exceed 1/200 of the span. Hardware and componentry may further restrict the spans. For advice we recommend you contact APL Technical Advisory Service



40MM WINDOW SERIES
SPAN TABLES

CAD REF. VC4020-0

DATE
01.06.11

SCALE
NTS

Extrusion: 08628
Description: Internal Box Transom

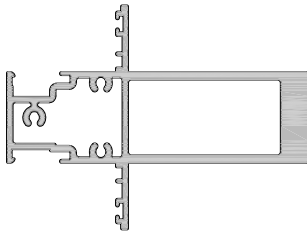
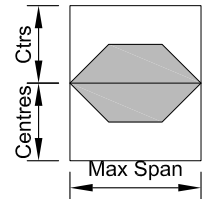

Centres	Spans for each wind zone			
	Low	Medium	High	Very High
1000	3785	3449	3069	2828
1100	3672	3348	2980	2747
1200	3573	3259	2902	2676
1300	3485	3179	2833	2614
1400	3406	3109	2771	2558
1500	3335	3045	2716	2508
1600	3271	2987	2666	2463
1700	3212	2934	2620	2422
1800	3158	2886	2579	2385
1900	3108	2841	2540	2350
2000	3062	2800	2505	2319

Extrusion: 08629
Description: Internal Box Sloped Transom

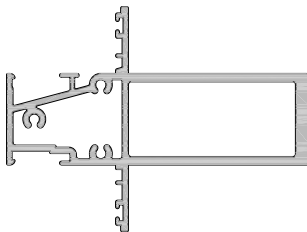
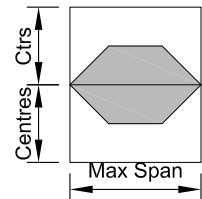

Centres	Spans for each wind zone			
	Low	Medium	High	Very High
1000	3505	3195	2844	2622
1100	3401	3102	2763	2548
1200	3311	3020	2692	2484
1300	3230	2948	2629	2427
1400	3158	2883	2573	2376
1500	3093	2825	2522	2331
1600	3034	2772	2477	2290
1700	2980	2724	2435	2253
1800	2931	2681	2398	2219
1900	2885	2640	2363	2188
2000	2844	2603	2331	2160

Extrusion: 08651
Description: Seismic Transom

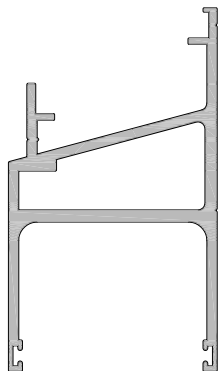
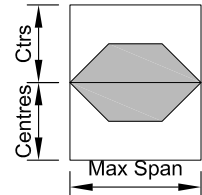

Centres	Spans for each wind zone			
	Low	Medium	High	Very High
1000	2627	2399	2141	1978
1100	2553	2333	2084	1927
1200	2489	2276	2035	1883
1300	2432	2225	1991	1844
1400	2381	2180	1953	1810
1500	2336	2140	1919	1780
1600	2295	2104	1888	1753
1700	2257	2071	1861	1728
1800	2224	2041	1835	1723
1900	2192	2014	1829	1718
2000	2164	1991	1824	1713

Spans are the maximum calculated allowable, based on NZS4211:2008, which requires that the member deflection at serviceability wind pressure (SWP) shall not exceed 1/200 of the span. Hardware and componentry may further restrict the spans. For advice we recommend you contact APL Technical Advisory Service



40MM WINDOW SERIES
SPAN TABLES

CAD REF. VC4021-0

DATE
01.06.11

SCALE
NTS

Extrusion: 08481
Description: Mullion

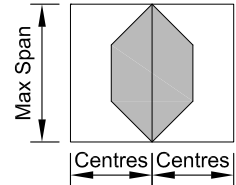
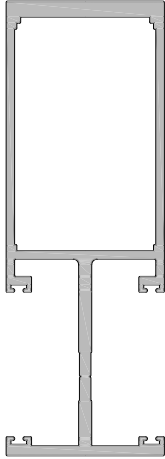

Centres	Spans for each wind zone			
	Low	Medium	High	Very High
1000	5680	5171	4593	4226
1100	5506	5013	4454	4099
1200	5353	4874	4331	3987
1300	5216	4751	4222	3888
1400	5093	4639	4124	3799
1500	4981	4538	4036	3718
1600	4880	4447	3955	3645
1700	4786	4363	3882	3578
1800	4701	4285	3814	3516
1900	4621	4214	3751	3459
2000	4548	4147	3693	3406

Extrusion: 08652
Description: 90° Corner Post

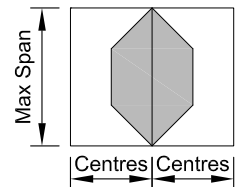
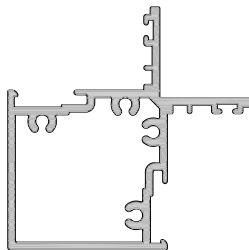

Centres	Spans for each wind zone			
	Low	Medium	High	Very High
1000	2008	1839	1648	1509
1100	1956	1793	1609	1473
1200	1911	1753	1576	1449
1300	1871	1718	1547	1435
1400	1836	1688	1522	1417
1500	1805	1661	1499	1414
1600	1777	1637	1494	1409
1700	1752	1630	1489	1404
1800	1742	1625	1484	1399
1900	1737	1620	1479	1394
2000	1732	1615	1474	1389

Extrusion: 08653 / 08654
Description: Pipe Chair / Fin Pipe

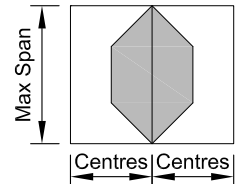
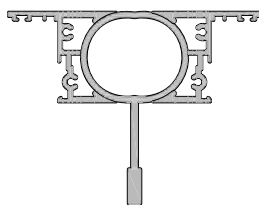

Centres	Spans for each wind zone			
	Low	Medium	High	Very High
1000	2989	2727	2430	2243
1100	2902	2650	2363	2182
1200	2827	2582	2305	2130
1300	2760	2522	2253	2084
1400	2701	2469	2207	2043
1500	2647	2421	2167	2006
1600	2598	2378	2130	1973
1700	2554	2339	2096	1943
1800	2514	2304	2066	1916
1900	2477	2271	2038	1893
2000	2443	2241	2012	1888

Spans are the maximum calculated allowable, based on NZS4211:2008, which requires that the member deflection at serviceability wind pressure (SWP) shall not exceed 1/200 of the span. Hardware and componentry may further restrict the spans.