



**VANTAGE THERMAL HEART  
AWNING WINDOW  
BEAD OPTIONS  
CROSS SECTION**

CAD REF. VRTAW02-0

DATE  
26.01.18

SCALE  
1:2

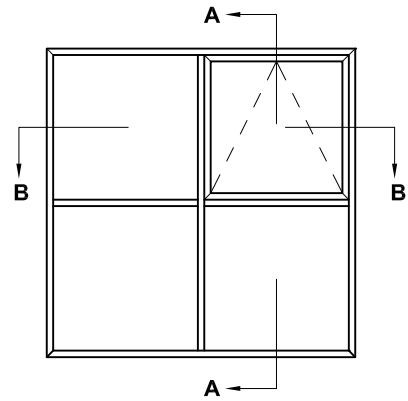
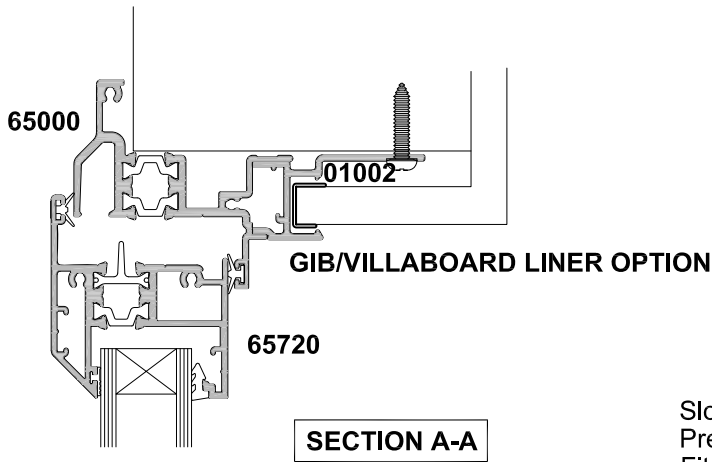

Sloped  
Pressure  
Fit Bead

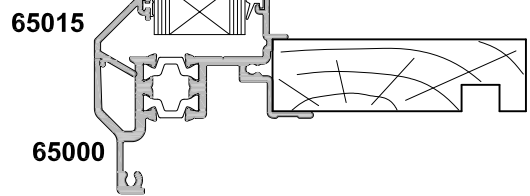

Square  
Pressure  
Fit Bead

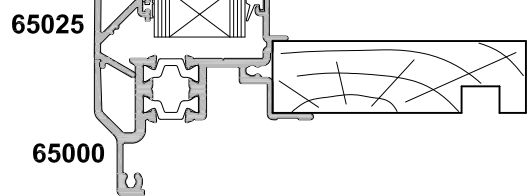

Square  
Wedged  
Bead

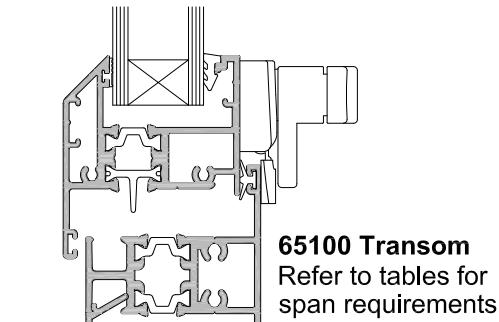
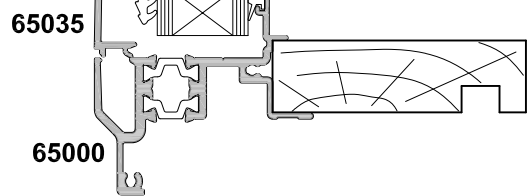

**65015**

Sloped  
Pressure  
Fit Bead

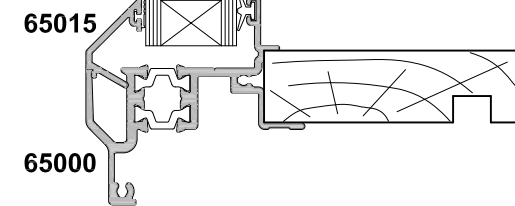
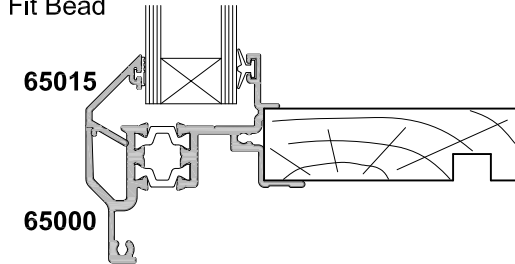

**65100 Light Mullion**  
Refer to tables for span  
requirements and other  
external fin mullion options

**SECTION B-B**

