



**40MM WINDOW SERIES
STRIP WINDOW
SQUARE BEAD
CROSS SECTION**

CAD REF. VC4004-0

DATE
01.06.11

SCALE
1:2

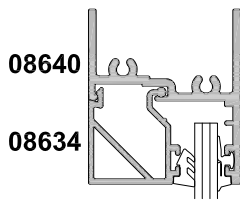
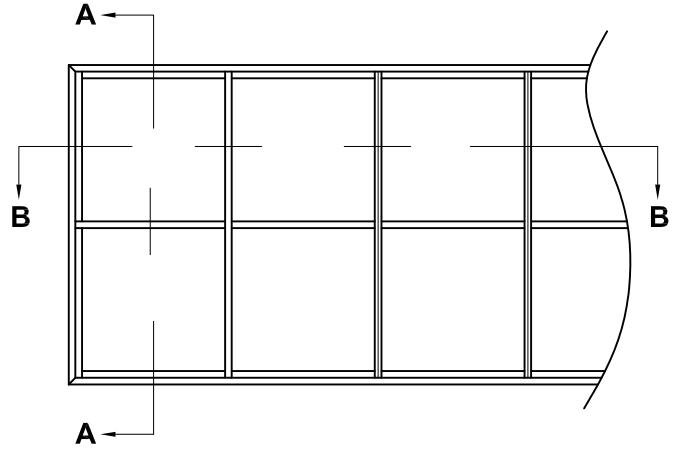

SECTION A-A

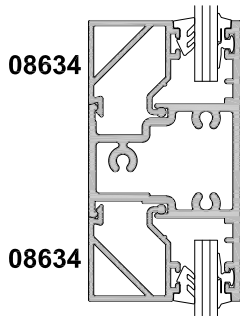

08625 Transom
Refer to tables for span requirements

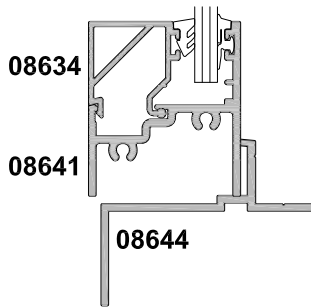

08644

SECTION B-B

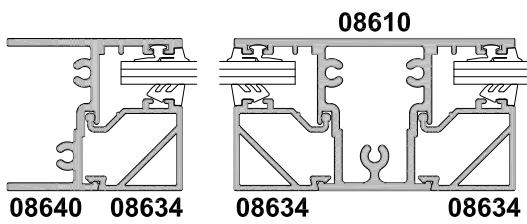

08610

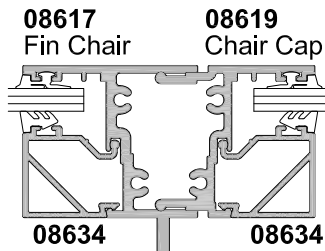

**08617
Fin Chair**

**08619
Chair Cap**

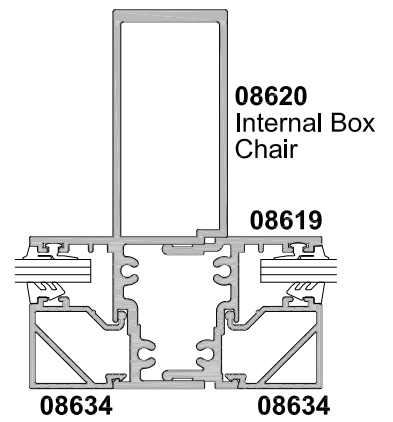

**08620
Internal Box
Chair**

08619

Refer to tables for span requirements