

**TIPS FOR ARCHITECTS AND DESIGNERS:
TYPICAL FOR ALL SUITES**

- 6MM - 13MM MAXIMUM LAMINATED GLASS SIZE
- 13MM PLASTERBOARD ONLY
- 105MM PROFILES = 64MM STUD
- 132MM PROFILES = 92MM STUD
- SD = SINGLE/DOUBLE ACOUSTIC WALL LININGS
- DD = DOUBLE/DOUBLE ACOUSTIC WALL LININGS
- FOR SOUND TRANSMISSION CLASS POINTS (STC) REFER TO THE POTTERS WEBSITE WWW.POTTERS.CO.NZ IN THE "PARTITIONING" SECTION

**POTTER ALUMINIUM SYSTEMS
A SERIES 105 - DETAIL REFERENCES**

2.2.1
SHEET

SCALE

A 01/04/2020
ISSUED DATE

0800 POTTER (0800 768 837) WWW.POTTERS.CO.NZ
SUBJECT TO CHANGE WITHOUT NOTICE



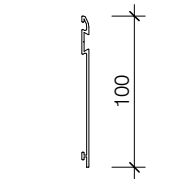

PAS009
100MM SKIRTING

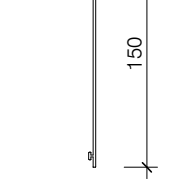

PAS009/B
150MM SKIRTING

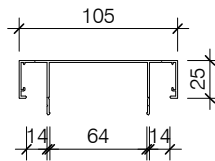

PAS010
105 HEAD/SILL TRACK

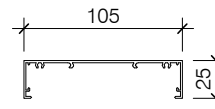

PAS010/A
105 CAPPING HEAD/FRAME

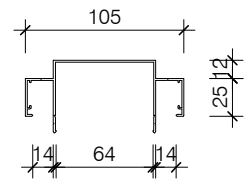

PAS010/C
105 SHADOWLINE HEADTRACK

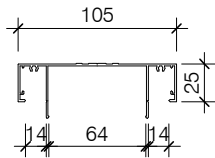

PAS010/R
105 HEAD-SILL TRACK

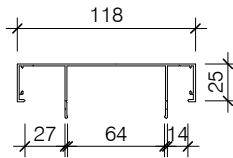

PAS010/SD
105 HEAD/SILL TRACK 3 LAYERS

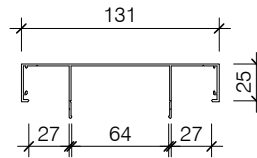

PAS010/DD
105 HEAD/SILL TRACK 4 LAYERS

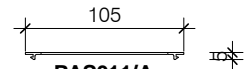

PAS011/A
105 FLAT TERMINATION CAP

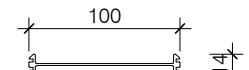

PAS011/D
105 JOINING PLATE

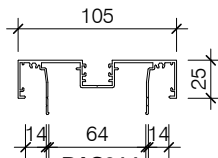

PAS014
105 PLASTERBOARD POCKET CAPPING FRAME

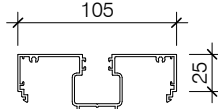

PAS014/A
105 GLAZING ADAPTOR

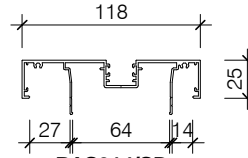

PAS014/SD
105 PLASTERBOARD POCKET CAPPING FRAME 3 LAYERS

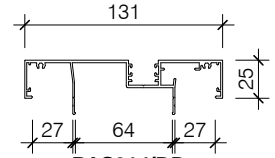

PAS014/DD
105 PLASTERBOARD POCKET CAPPING FRAME 4 LAYERS

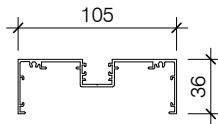

PAS015
105 MEDIUM POCKET CAPPING/FRAME

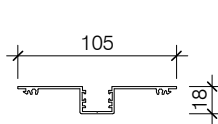

PAS016
105 SNAP IN POCKET

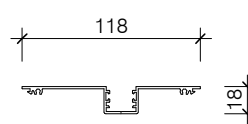

PAS016/SD
105 SNAP IN POCKET 3 LAYERS

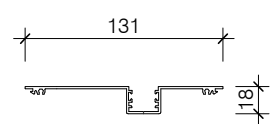

PAS016/DD
105 SNAP IN POCKET 4 LAYERS

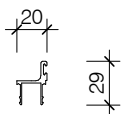

PAS017
105 SNAP IN DOORSTOP UP TO 40MM DOORS

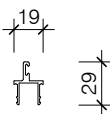

PAS018
105 SNAP IN DOORSTOP UP TO 50MM DOORS

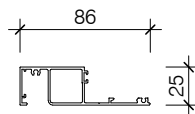

PAS019
105 WIDELINE GLAZING SILL

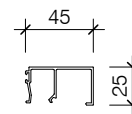

PAS020
105 GLAZING BEAD

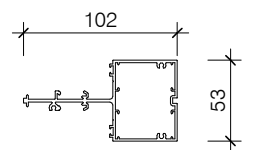

PAS021/B
105 GLAZING SILL/TRANSOM

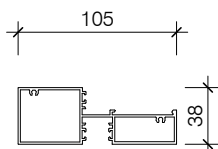

PAS021/A
105 GLAZING SILL/TRANSOM

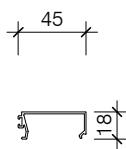

PAS022
105 TRANSOM BEAD

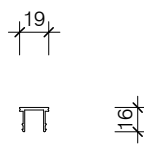

PAS023
105 POCKET FLUSH FILLER

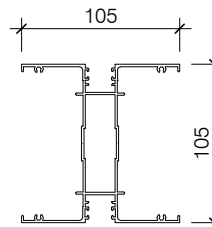

PAS024
105 GLAZING CORNER POST

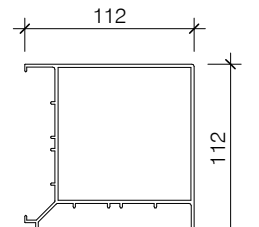

PAS024/JX
105 CORNER POST

**POTTER ALUMINIUM SYSTEMS
A SERIES 105 - STANDARD SUITE PROFILES**

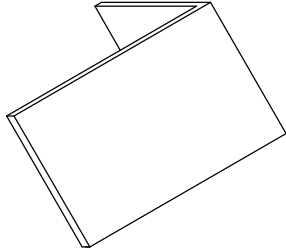

PASACC STAKE 1

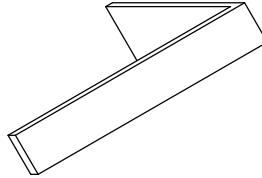

PASACC STAKE 3

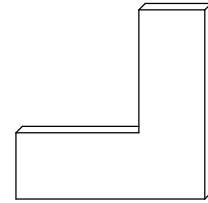

PASACC STAKE 6

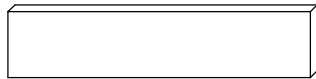

PASACC STAKE 7

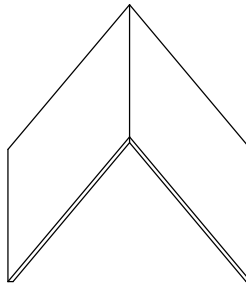

PASACC STAKE 8

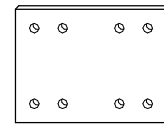

PASACC STAKE 9

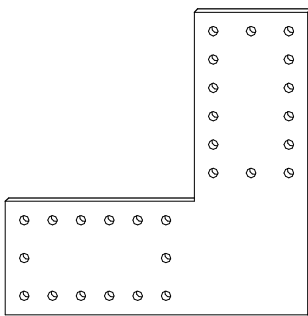

PASACC STAKE 10

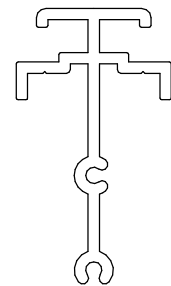

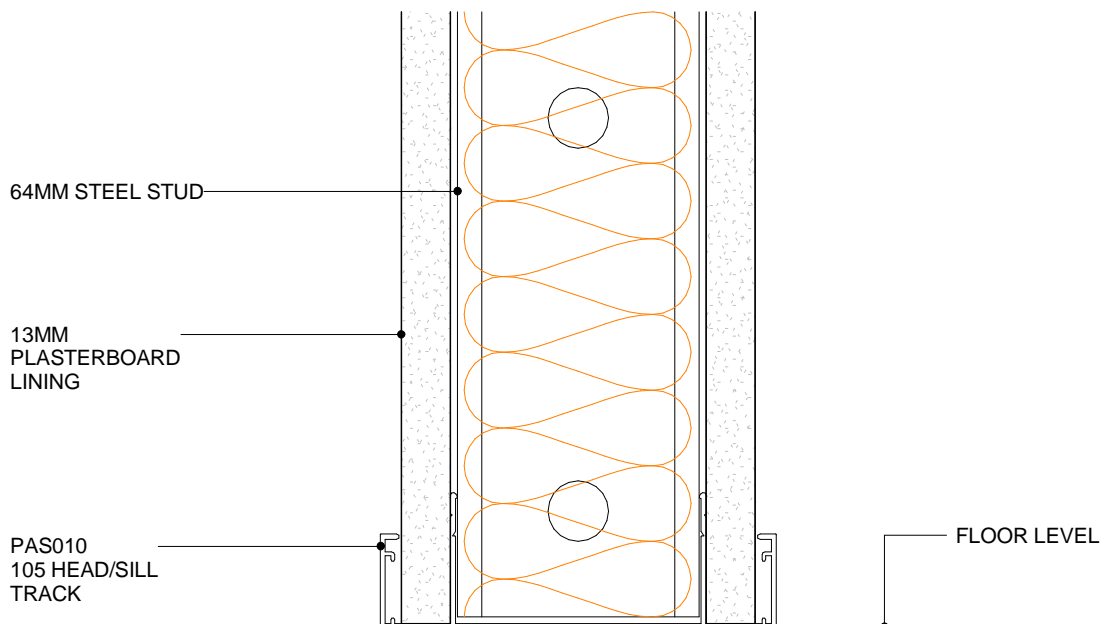
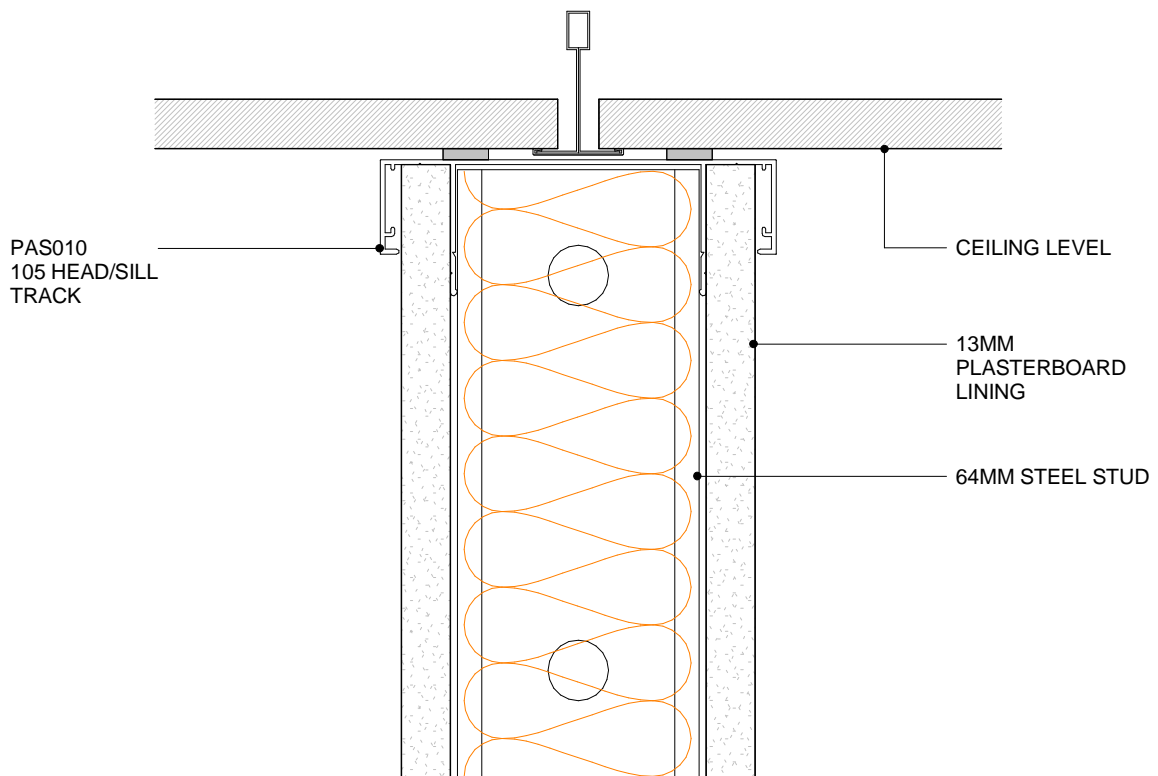

POTTER ALUMINIUM SYSTEMS
A SERIES 105 - 64MM - STEEL STUD WALL
CROSS SECTION

2.4.1
SHEET

1:2@A4
SCALE

A 01/04/2020
ISSUED DATE

0800 POTTER (0800 768 837) WWW.POTTERS.CO.NZ
SUBJECT TO CHANGE WITHOUT NOTICE



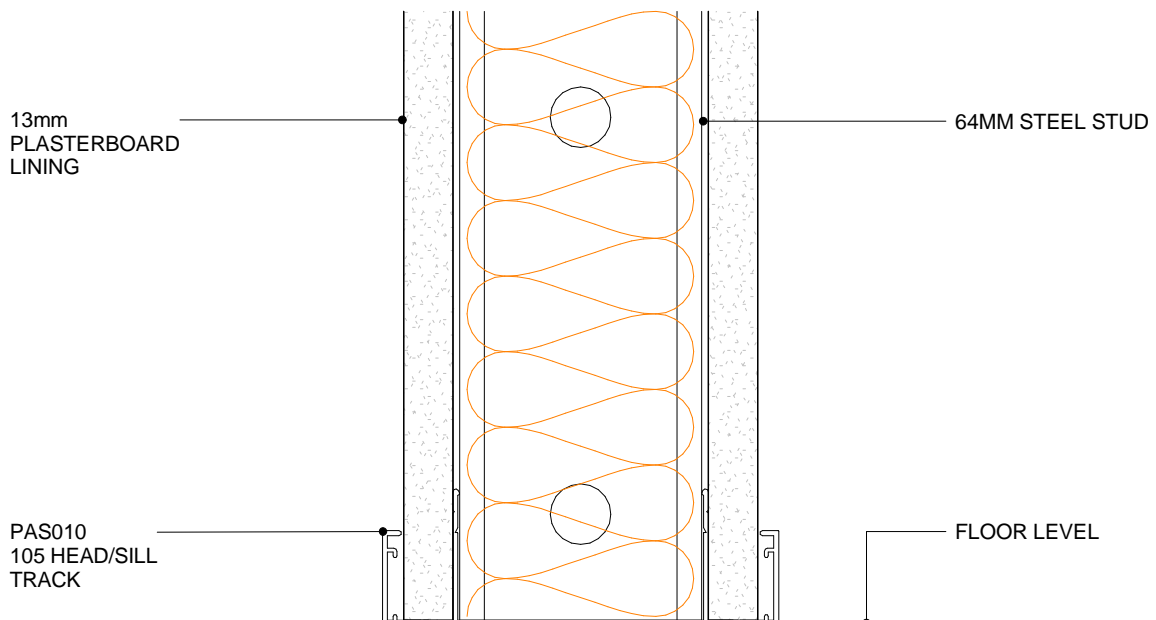
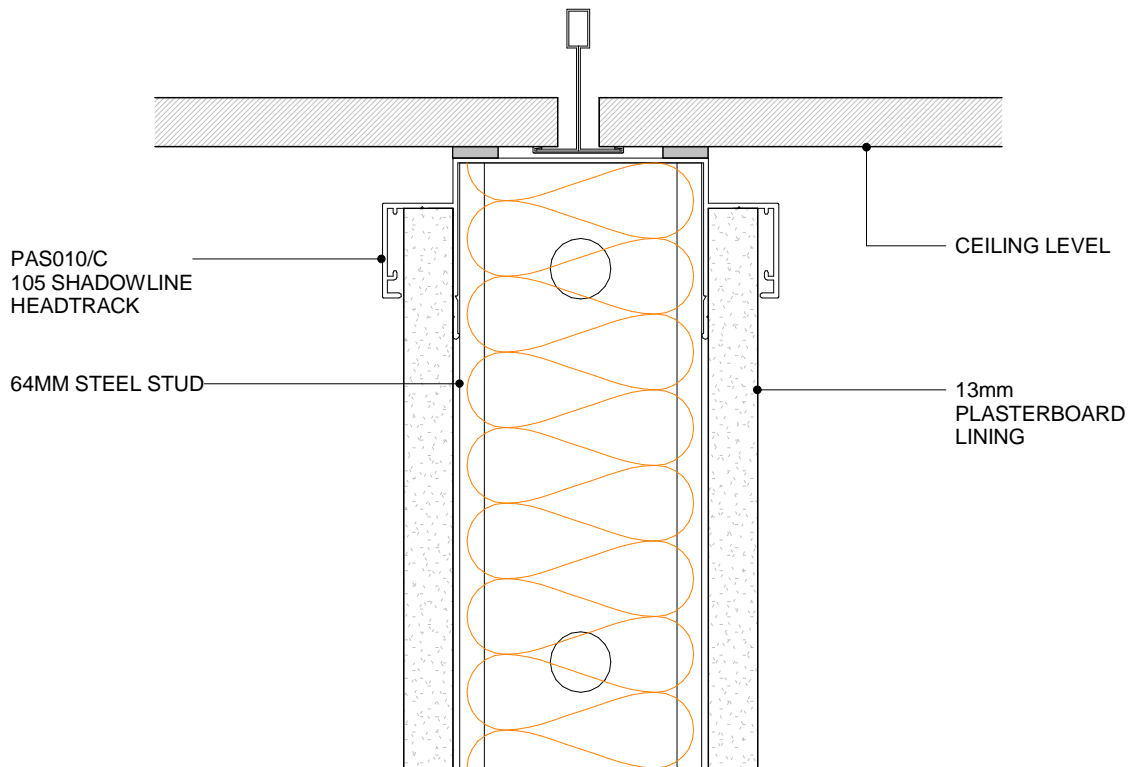

POTTER ALUMINIUM SYSTEMS
A SERIES 105 - 64MM - STEEL STUD WALL SHADOWLINE DETAIL
CROSS SECTION

2.4.2
SHEET

1:2@A4
SCALE

A 01/04/2020
ISSUED DATE

0800 POTTER (0800 768 837) WWW.POTTERS.CO.NZ
SUBJECT TO CHANGE WITHOUT NOTICE



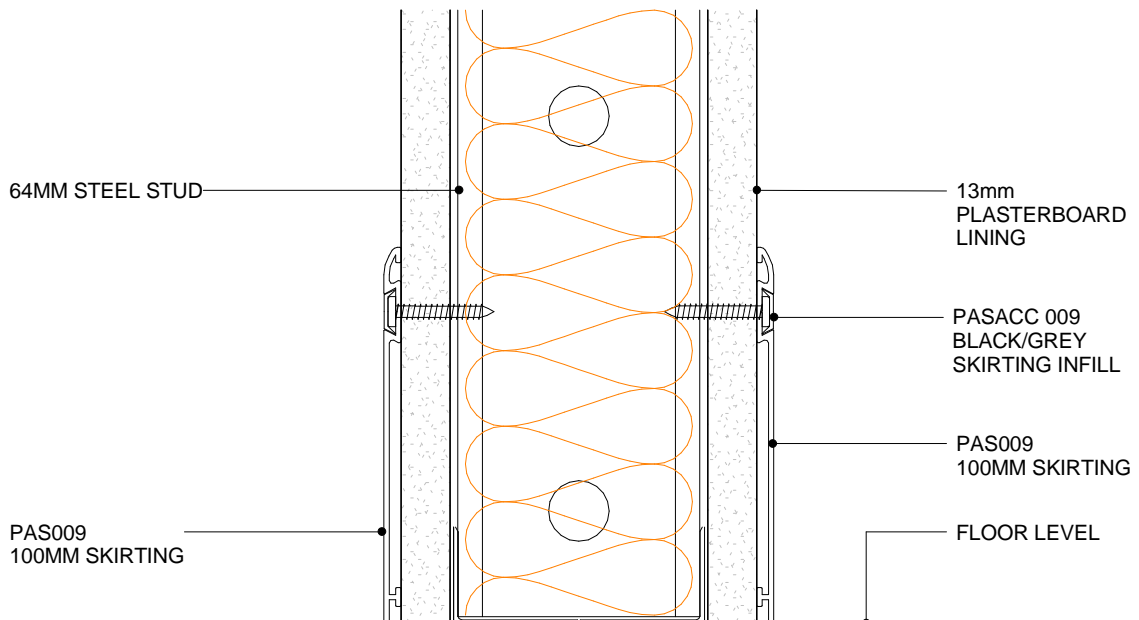
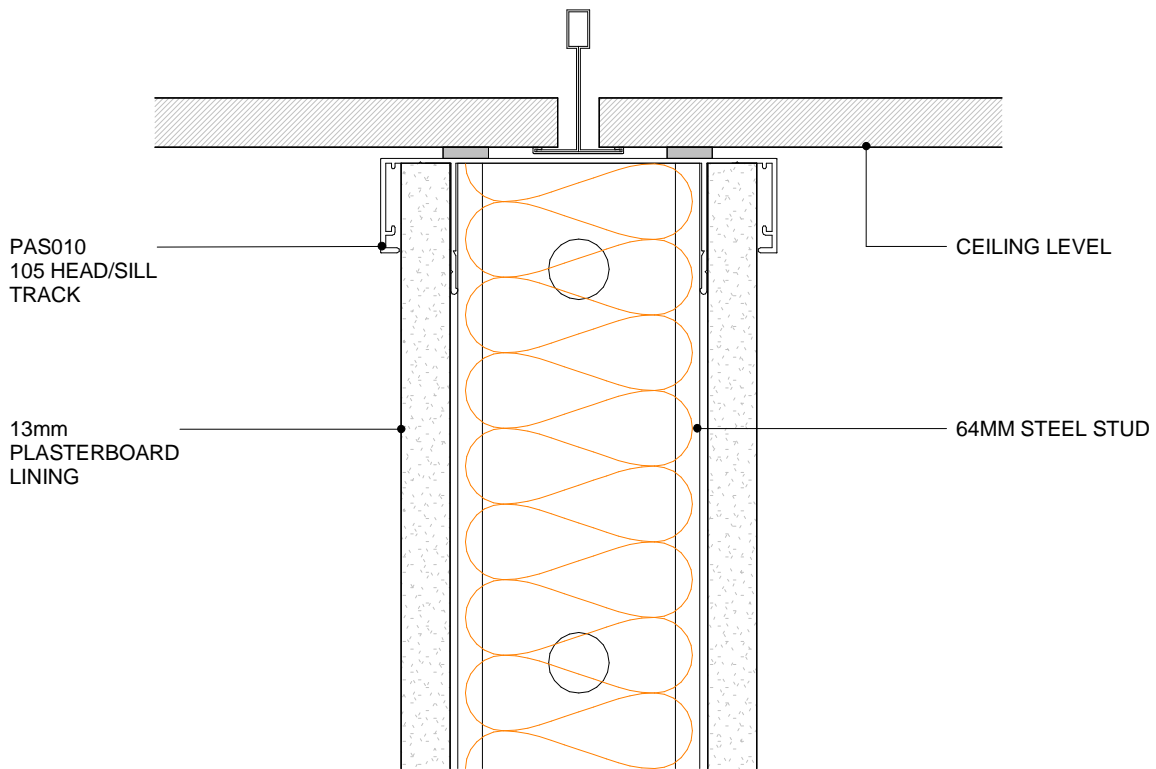

POTTER ALUMINIUM SYSTEMS
A SERIES 105 - 64MM - FULL HEIGHT STEEL STUD WALL SKIRTING
100MM
CROSS SECTION

2.4.3
 SHEET

1:2@A4
 SCALE

A 01/04/2020
 ISSUED DATE

0800 POTTER (0800 768 837) WWW.POTTERS.CO.NZ
 SUBJECT TO CHANGE WITHOUT NOTICE



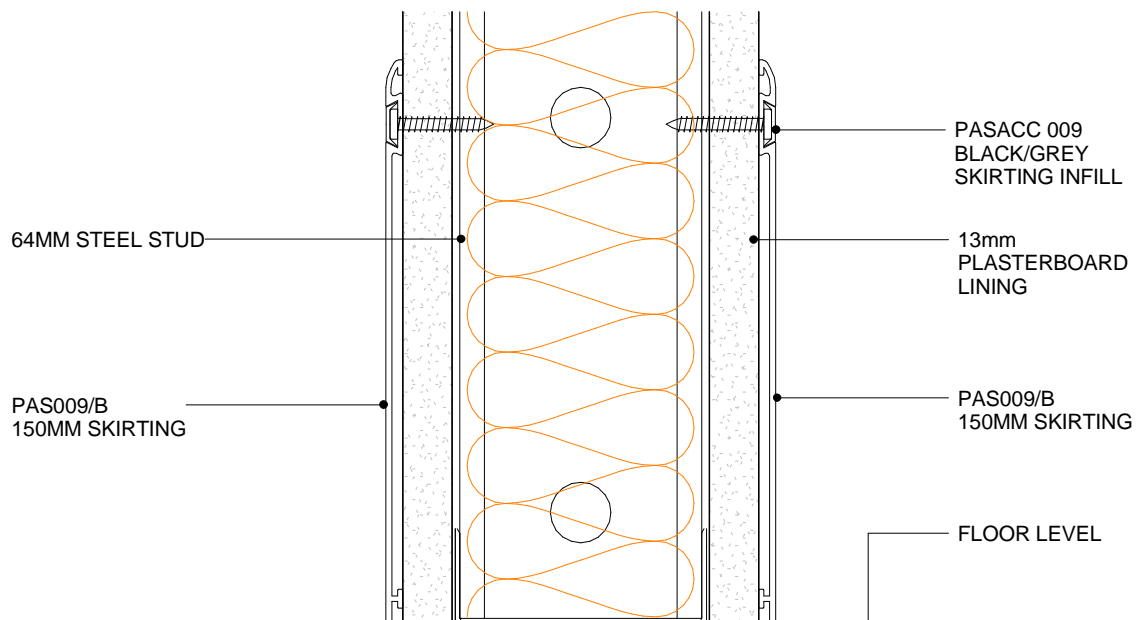
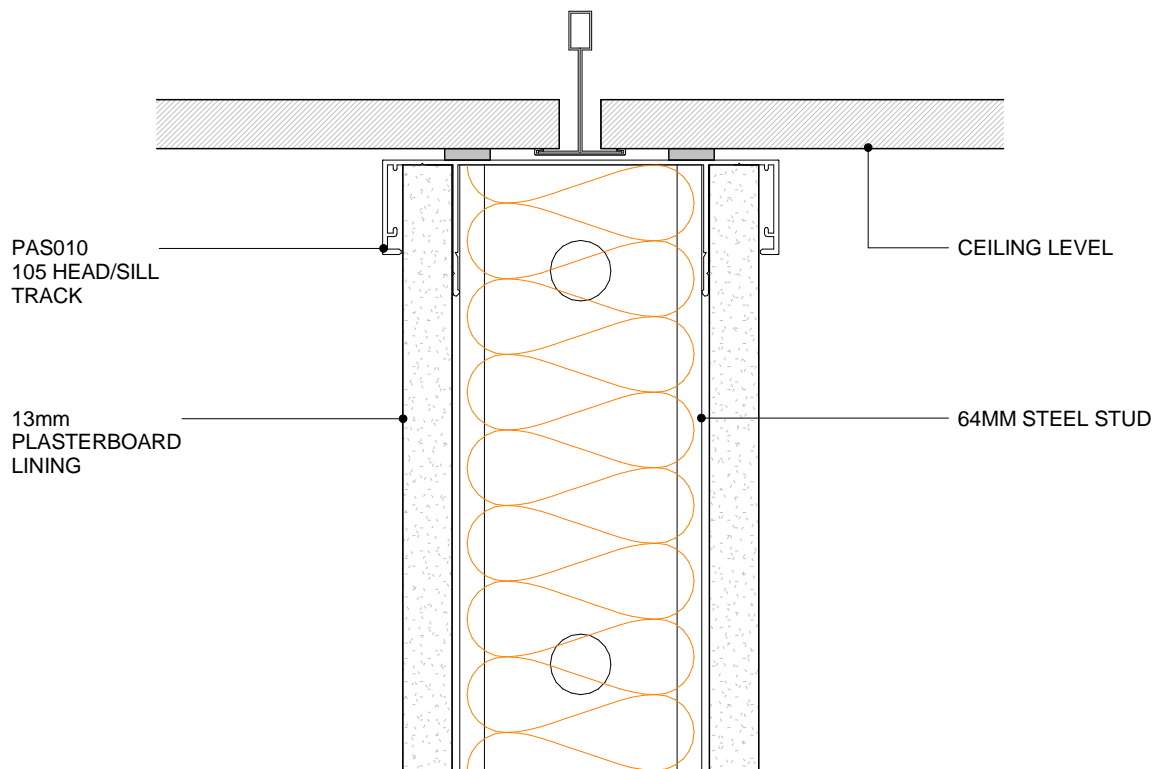

POTTER ALUMINIUM SYSTEMS
A SERIES 105 - 64MM - FULL HEIGHT STEEL STUD WALL SKIRTING
150MM
CROSS SECTION

2.4.4
SHEET

1:2@A4
SCALE

A 01/04/2020
ISSUED DATE

0800 POTTER (0800 768 837) WWW.POTTERS.CO.NZ
 SUBJECT TO CHANGE WITHOUT NOTICE



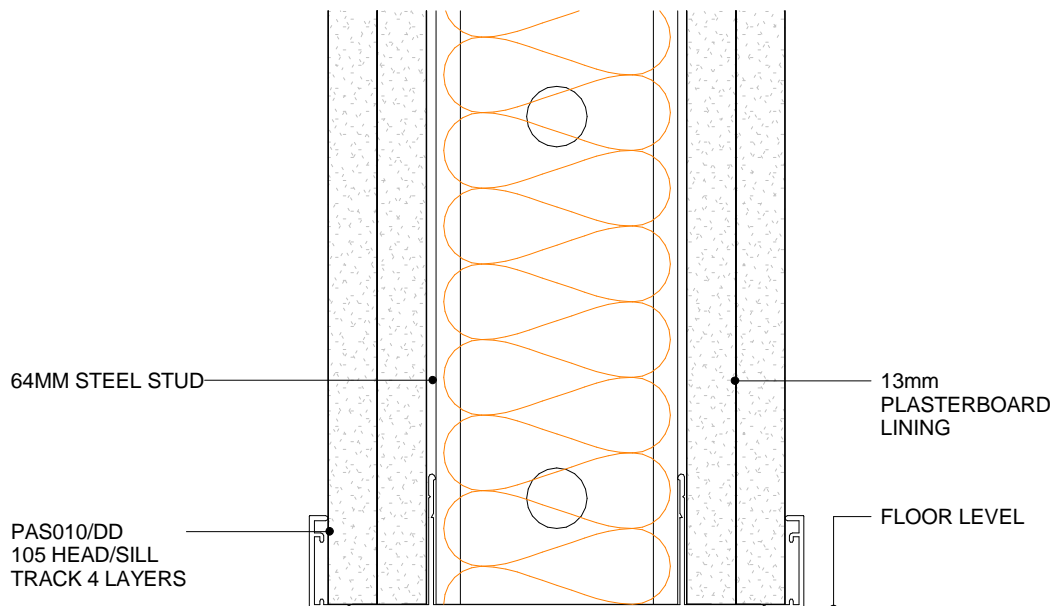
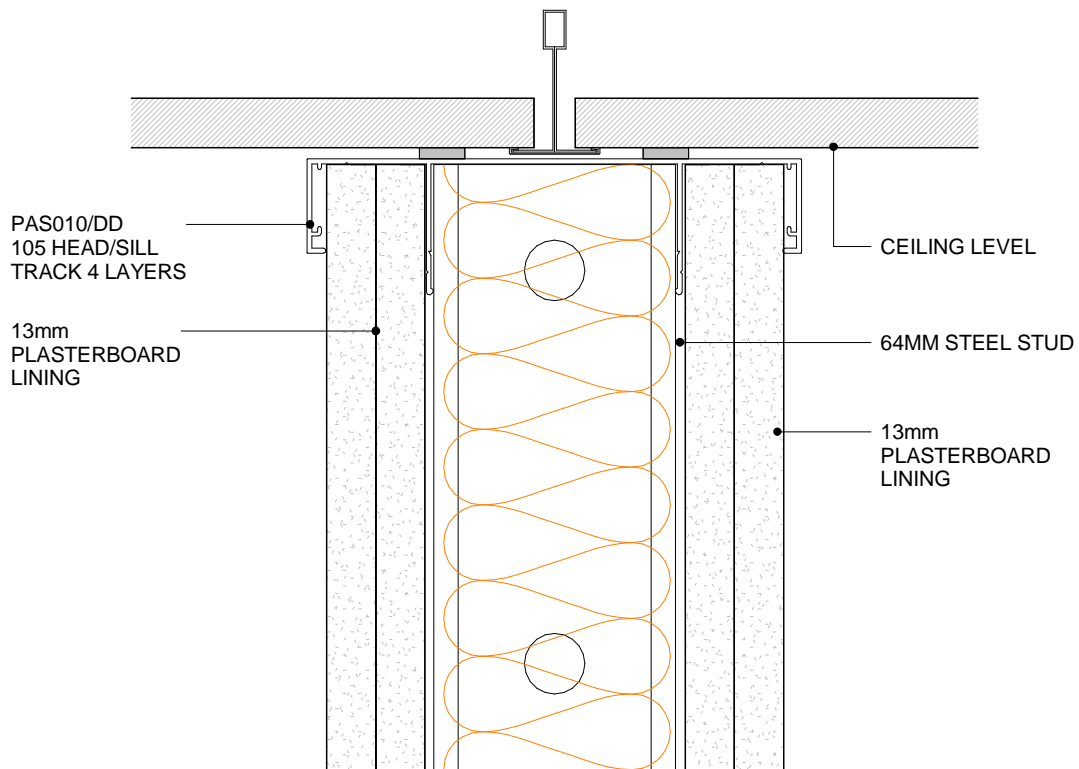

POTTER ALUMINIUM SYSTEMS
A SERIES 105 - 64MM - STEEL STUD ACOUSTIC WALL (4 LAYERS)
CROSS SECTION

2.4.5
SHEET

1:2@A4
SCALE

A 01/04/2020
ISSUED DATE

0800 POTTER (0800 768 837) WWW.POTTERS.CO.NZ
SUBJECT TO CHANGE WITHOUT NOTICE



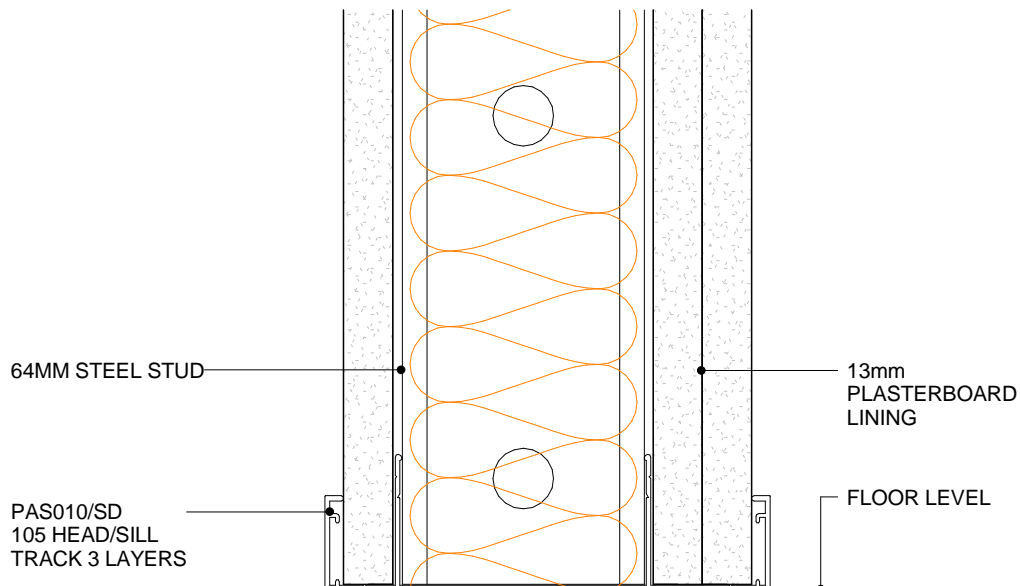
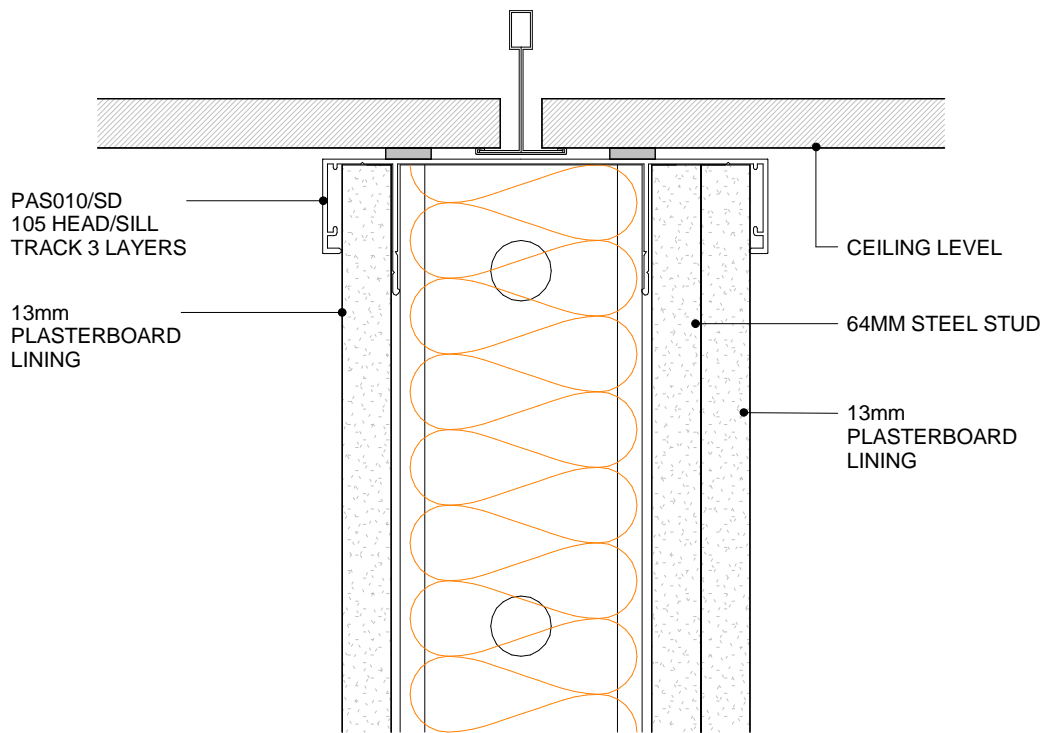

POTTER ALUMINIUM SYSTEMS
A SERIES 105 - 64MM - STEEL STUD ACOUSTIC WALL (3 LAYERS)
CROSS SECTION

2.4.6
SHEET

1:2@A4
SCALE

A 01/04/2020
ISSUED DATE

0800 POTTER (0800 768 837) WWW.POTTERS.CO.NZ
SUBJECT TO CHANGE WITHOUT NOTICE



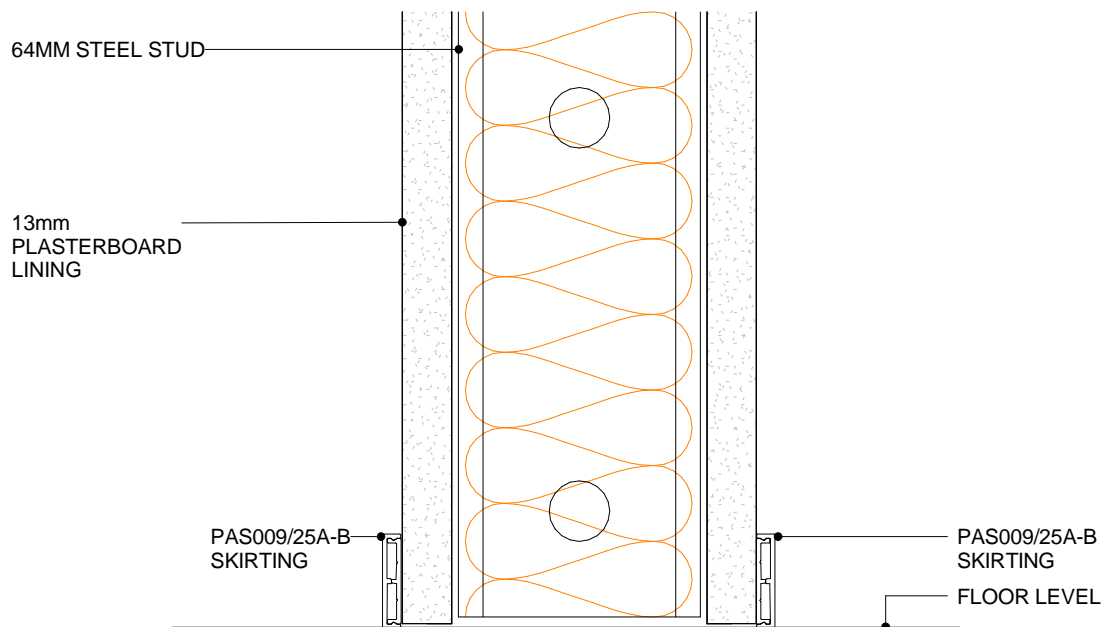
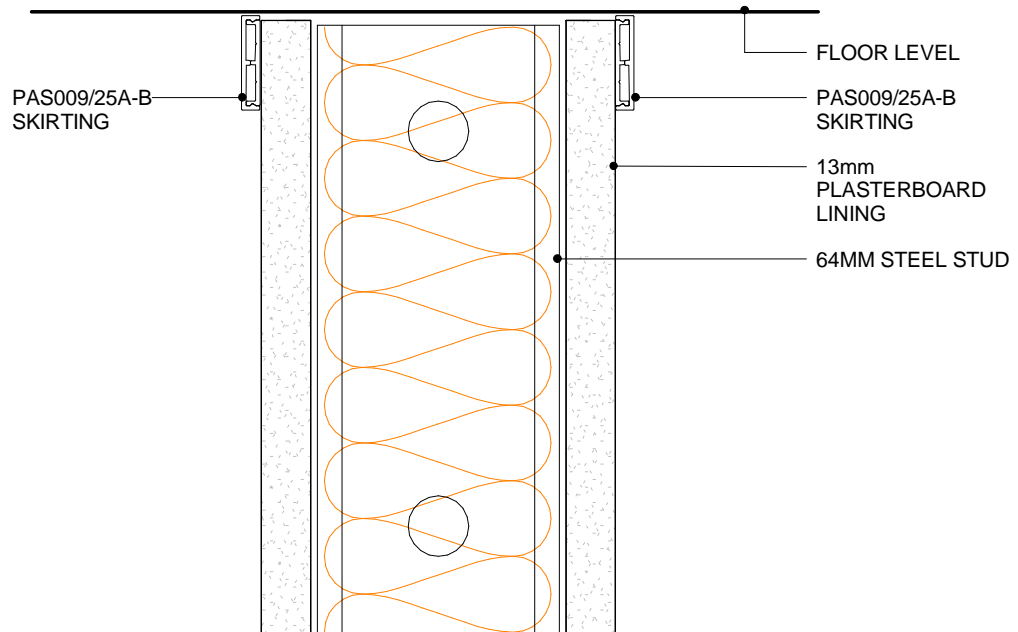

POTTER ALUMINIUM SYSTEMS
A SERIES 105 - 64MM - STEEL STUD FULL HT WALL SKIRTING
CROSS SECTION

2.4.9
SHEET

1:2@A4
SCALE

A 01/04/2020
ISSUED DATE

0800 POTTER (0800 768 837) WWW.POTTERS.CO.NZ
SUBJECT TO CHANGE WITHOUT NOTICE



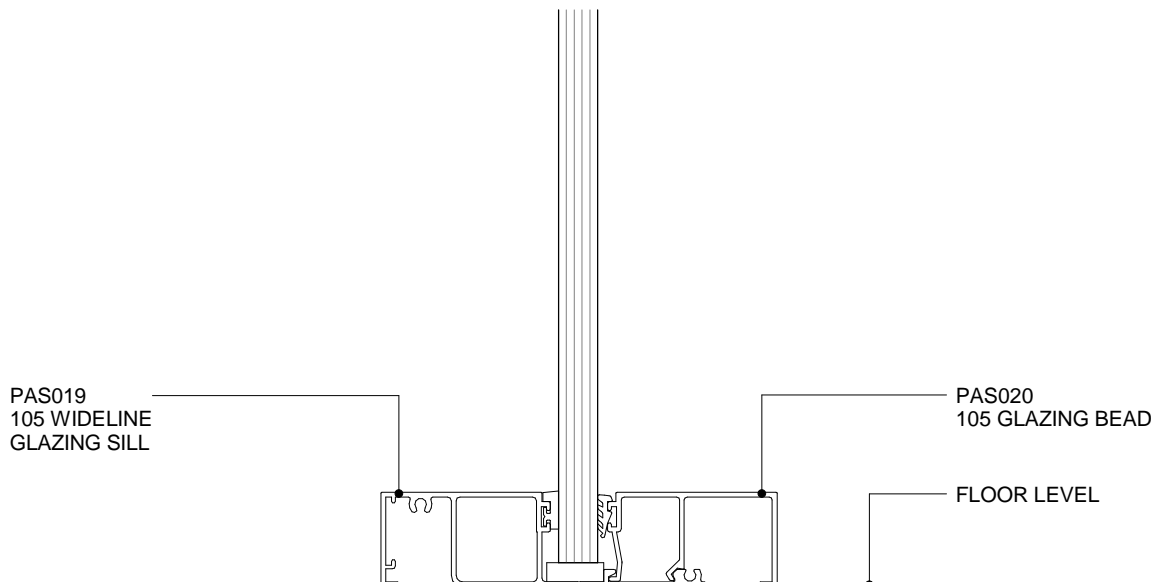
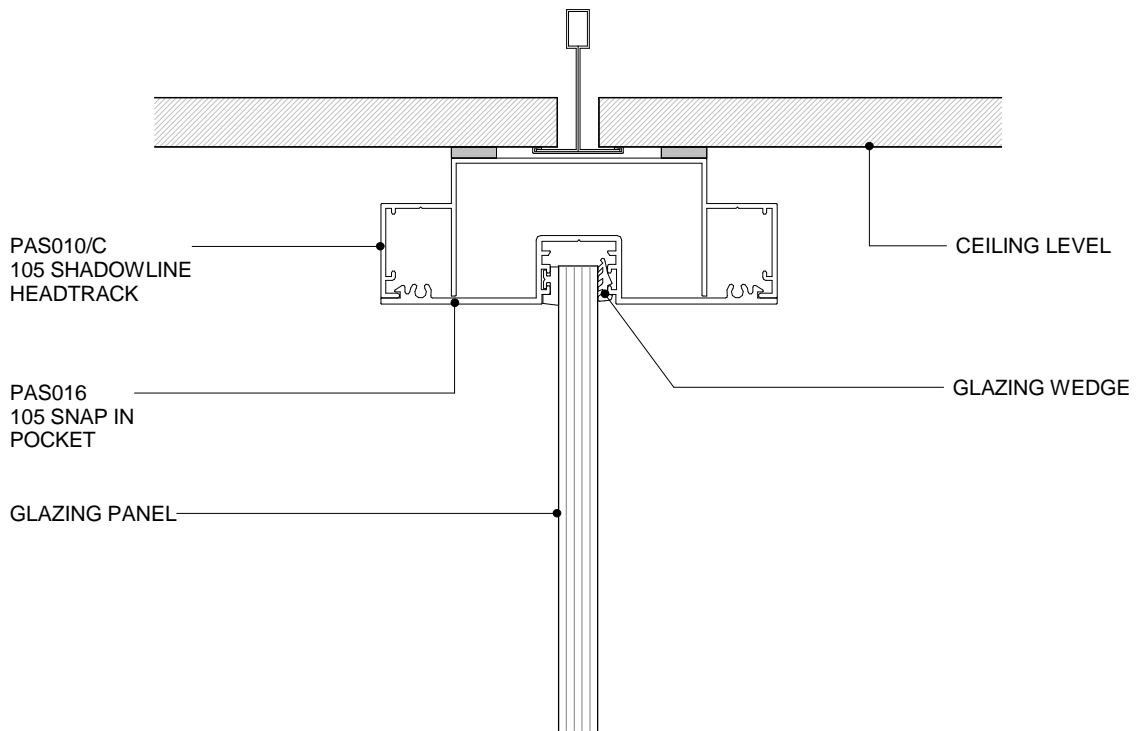

POTTER ALUMINIUM SYSTEMS
A SERIES 105 - 64MM - FULL HEIGHT GLAZING
CROSS SECTION

2.5.1
SHEET

1:2@A4
SCALE

A 01/04/2020
ISSUED DATE

0800 POTTER (0800 768 837) WWW.POTTERS.CO.NZ
SUBJECT TO CHANGE WITHOUT NOTICE



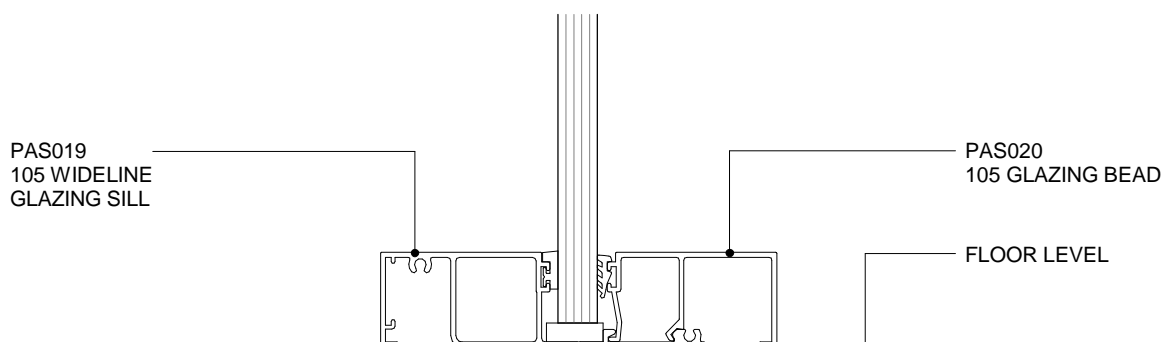
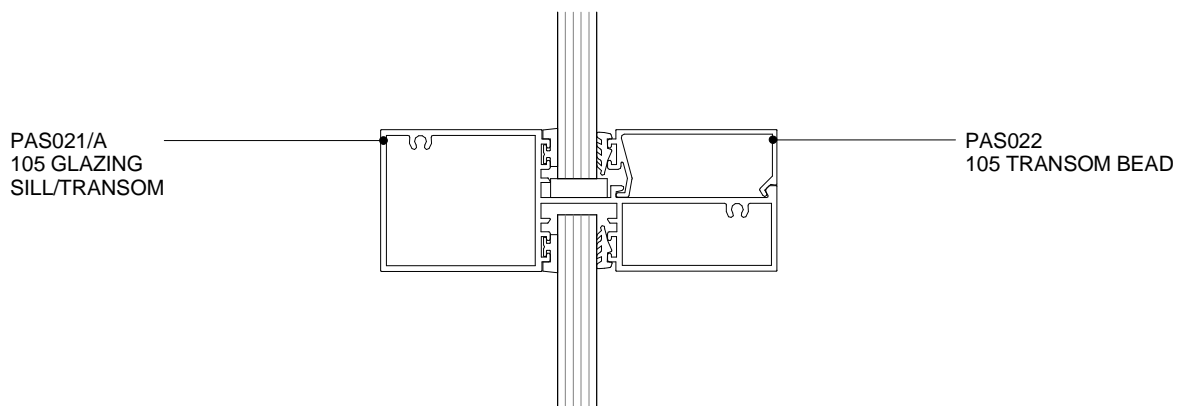
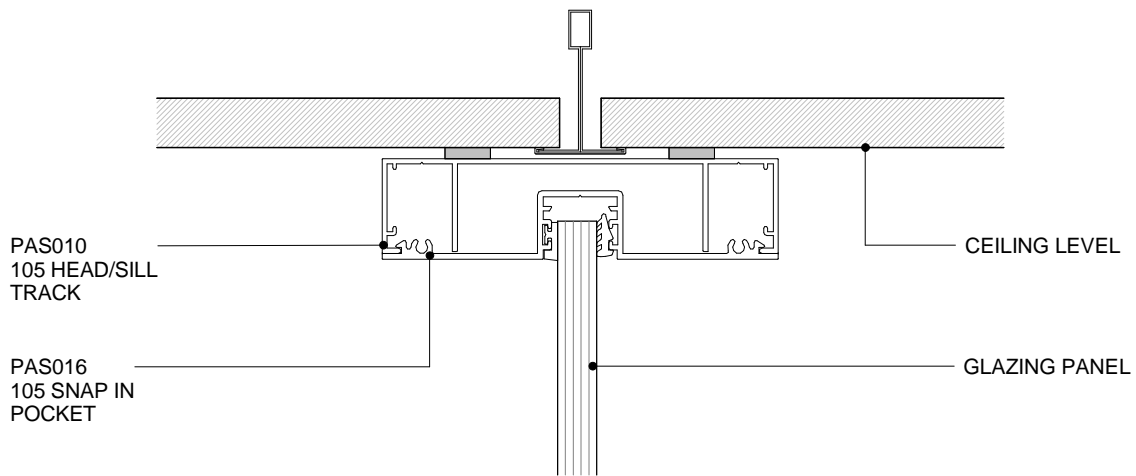

POTTER ALUMINIUM SYSTEMS
A SERIES 105 - 64MM - TRANSOM IN GLAZED WALL
CROSS SECTION

2.5.2
SHEET

1:2@A4
SCALE

A 01/04/2020
ISSUED DATE

0800 POTTER (0800 768 837) WWW.POTTERS.CO.NZ
SUBJECT TO CHANGE WITHOUT NOTICE



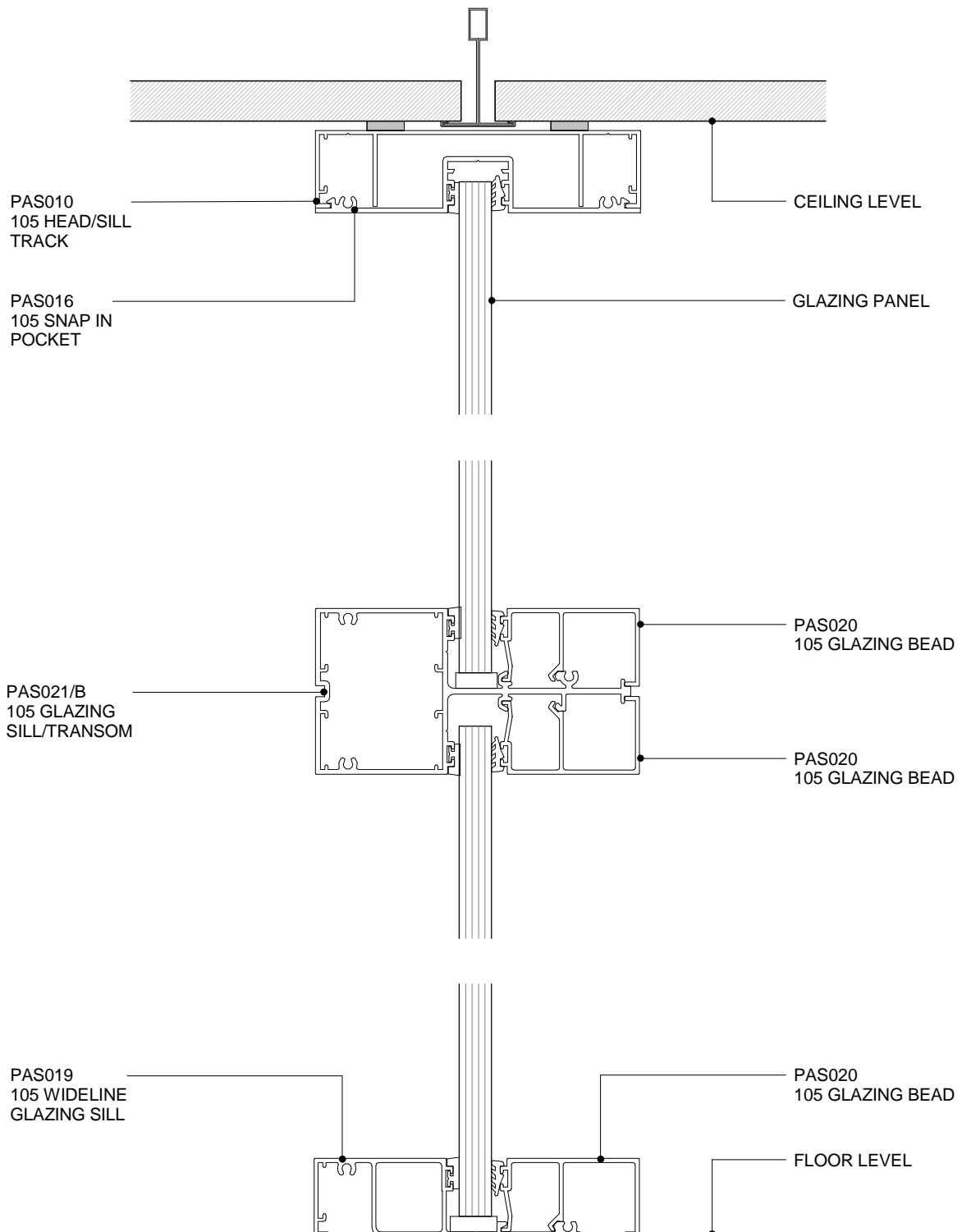

POTTER ALUMINIUM SYSTEMS
A SERIES 105 - 64MM - OPTIONAL TRANSOM IN GLAZED WALL
CROSS SECTION

2.5.3
 SHEET

1:2@A4
 SCALE

A 01/04/2020
 ISSUED DATE

0800 POTTER (0800 768 837) WWW.POTTERS.CO.NZ
 SUBJECT TO CHANGE WITHOUT NOTICE



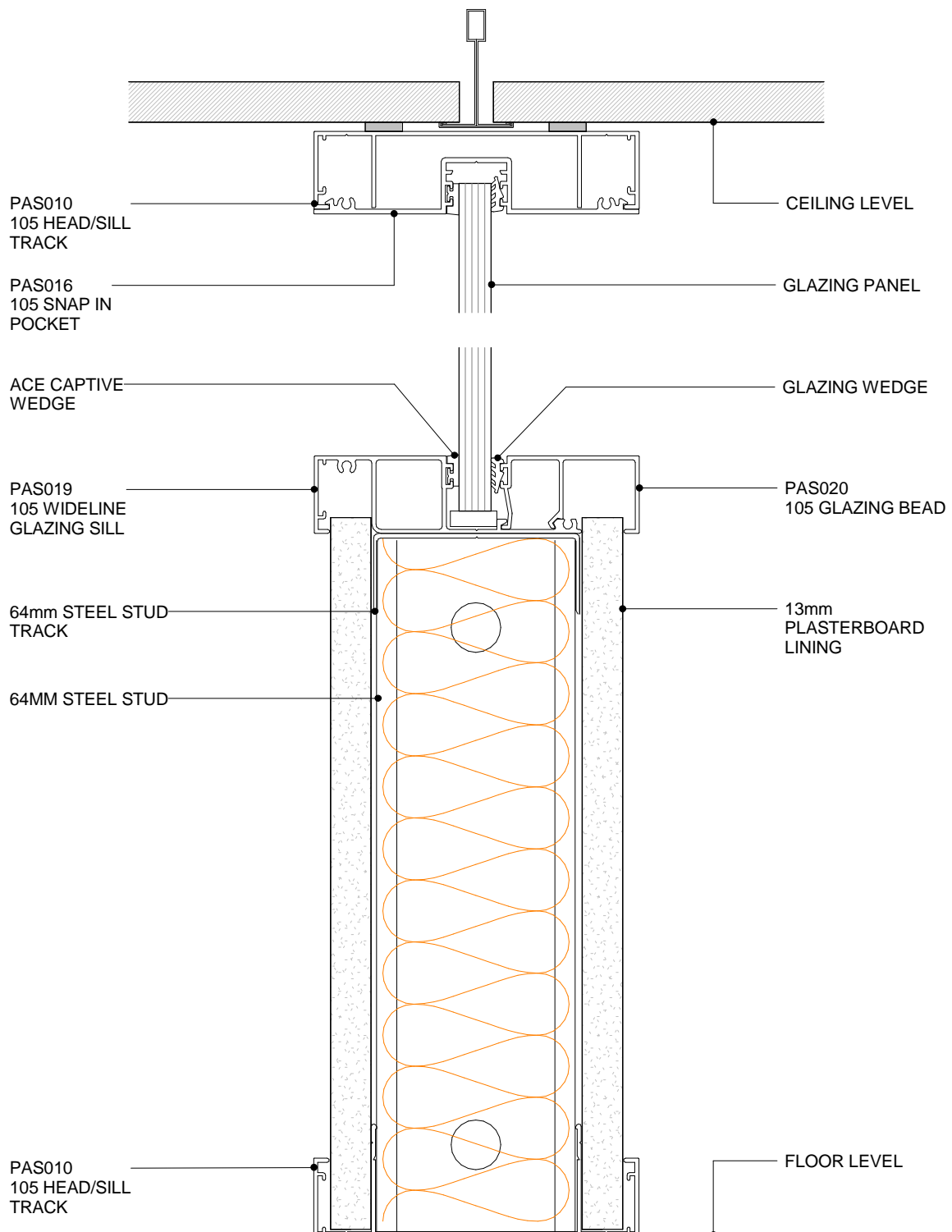

POTTER ALUMINIUM SYSTEMS
A SERIES 105 - 64MM - HALF HEIGHT GLAZED WALL
CROSS SECTION

2.5.4
 SHEET

1:2@A4
 SCALE

A 01/04/2020
 ISSUED DATE

0800 POTTER (0800 768 837) WWW.POTTERS.CO.NZ
 SUBJECT TO CHANGE WITHOUT NOTICE



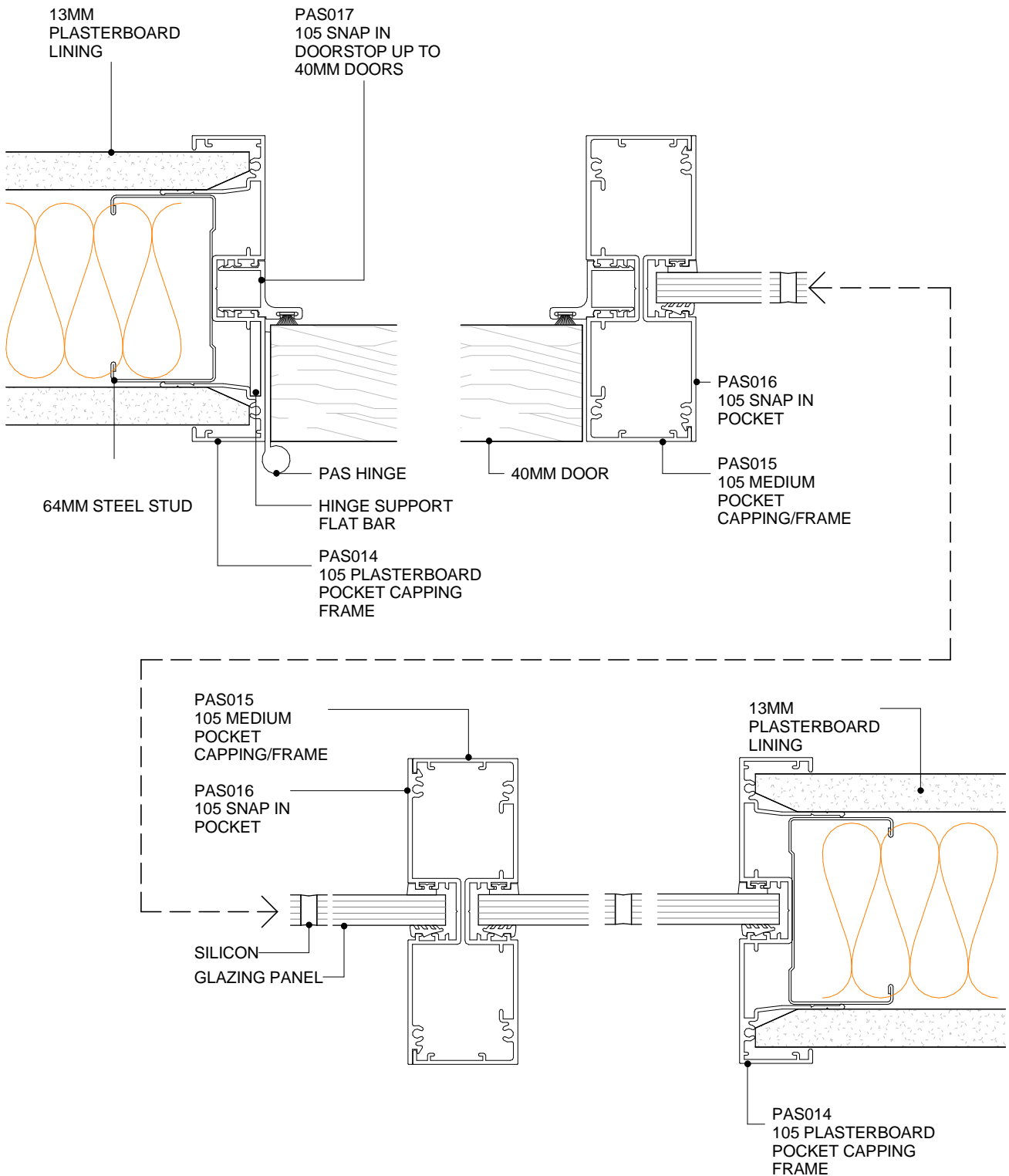

POTTER ALUMINIUM SYSTEMS
A SERIES 105 - 64MM - DOOR-GLAZING MULLION
PLAN VIEW

2.5.5
SHEET

1:2@A4
SCALE

A 01/04/2020
ISSUED DATE

0800 POTTER (0800 768 837) WWW.POTTERS.CO.NZ
 SUBJECT TO CHANGE WITHOUT NOTICE



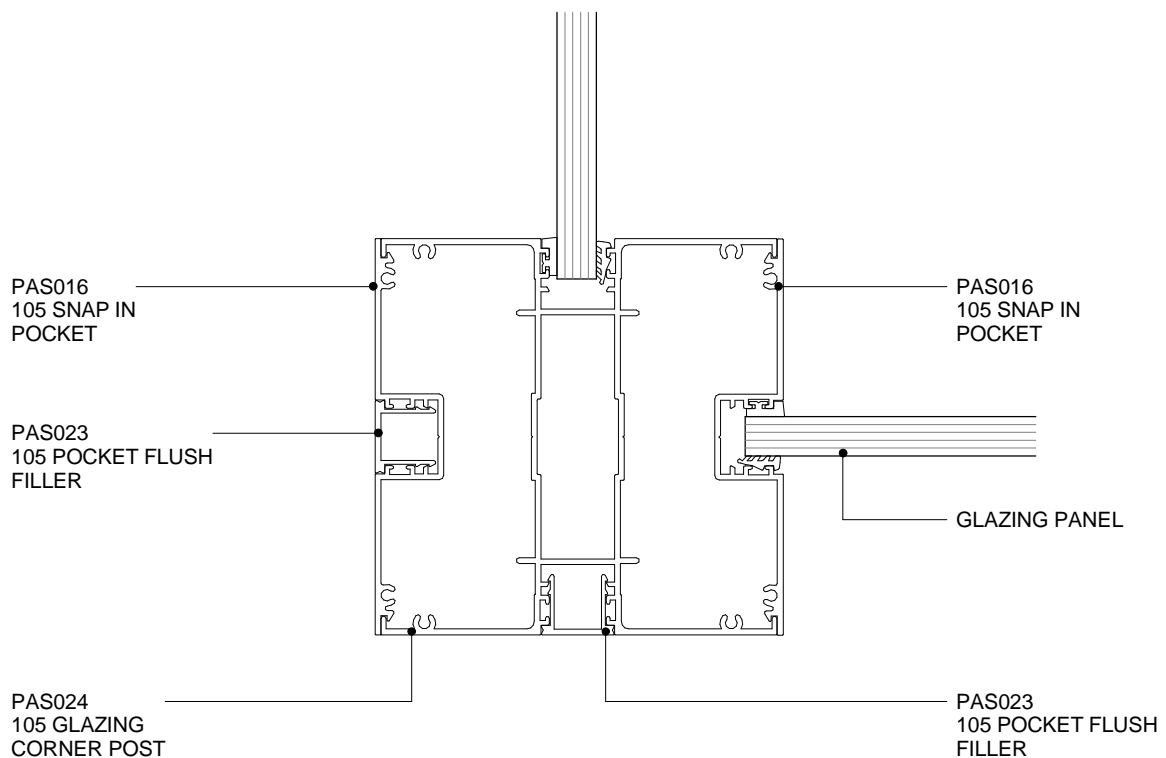
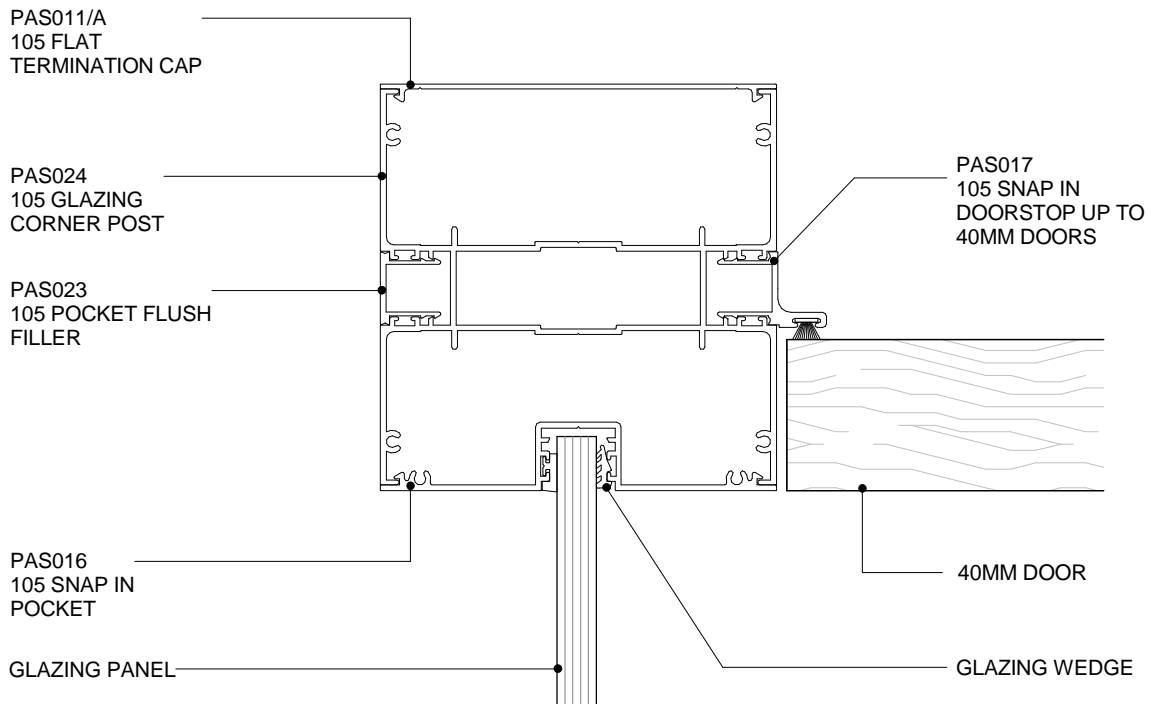

POTTER ALUMINIUM SYSTEMS
A SERIES 105 - 64MM - LARGE GLAZING POSTS
PLAN VIEW

2.5.7
SHEET

1:2@A4
SCALE

A 01/04/2020
ISSUED DATE

0800 POTTER (0800 768 837) WWW.POTTERS.CO.NZ
SUBJECT TO CHANGE WITHOUT NOTICE



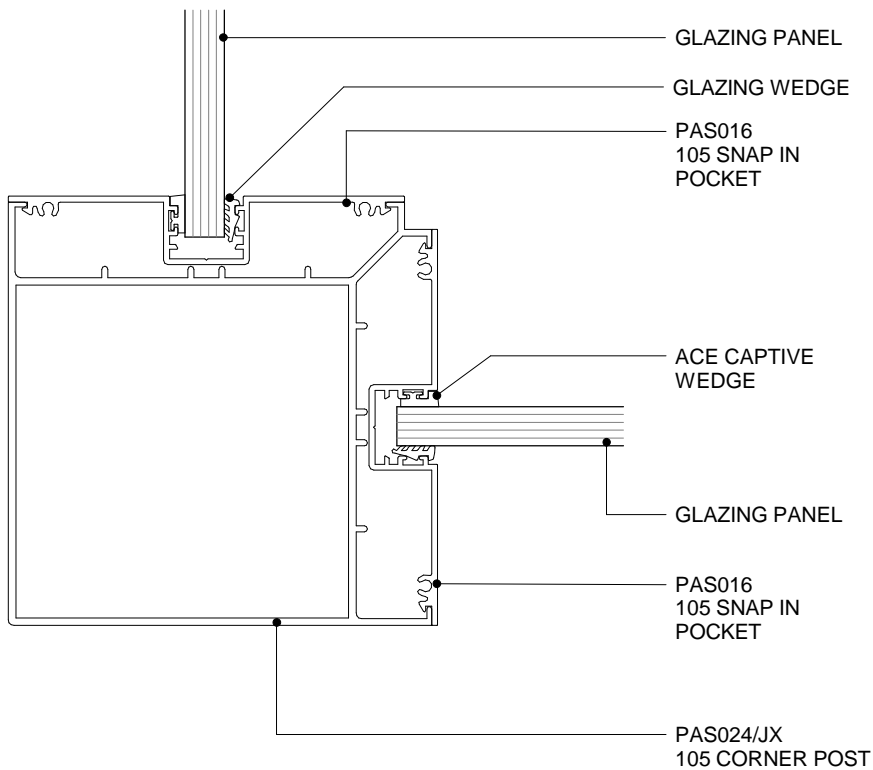
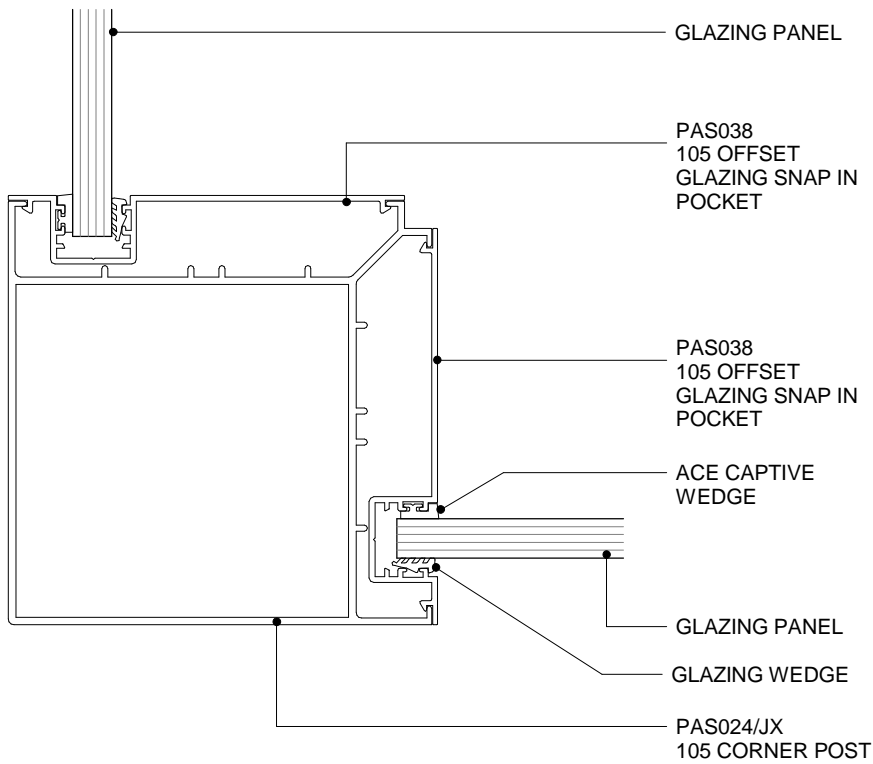

POTTER ALUMINIUM SYSTEMS
A SERIES 105 - 64MM - GLAZING CORNER POSTS SINGLE GLASS
PLAN VIEW

2.5.8
SHEET

1:2@A4
SCALE

A 01/04/2020
ISSUED DATE

0800 POTTER (0800 768 837) WWW.POTTERS.CO.NZ
SUBJECT TO CHANGE WITHOUT NOTICE



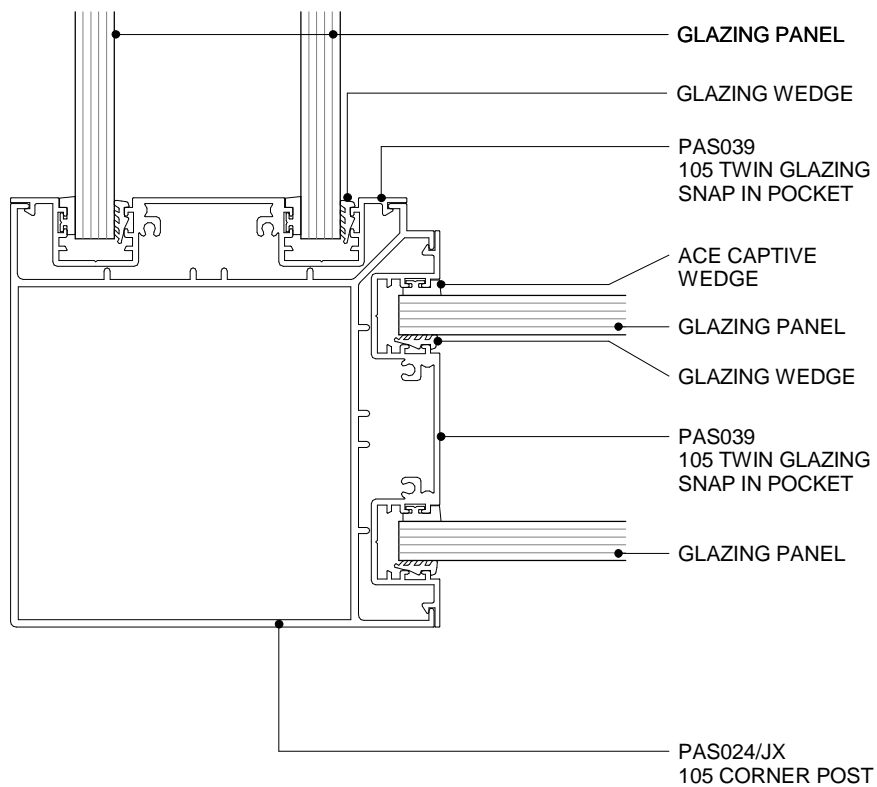

POTTER ALUMINIUM SYSTEMS
A SERIES 105 - 64MM - GLAZING CORNER POSTS DOUBLE GLASS
PLAN VIEW

2.5.9
SHEET

1:2@A4
SCALE

A 01/04/2020
ISSUED DATE

0800 POTTER (0800 768 837) WWW.POTTERS.CO.NZ
SUBJECT TO CHANGE WITHOUT NOTICE



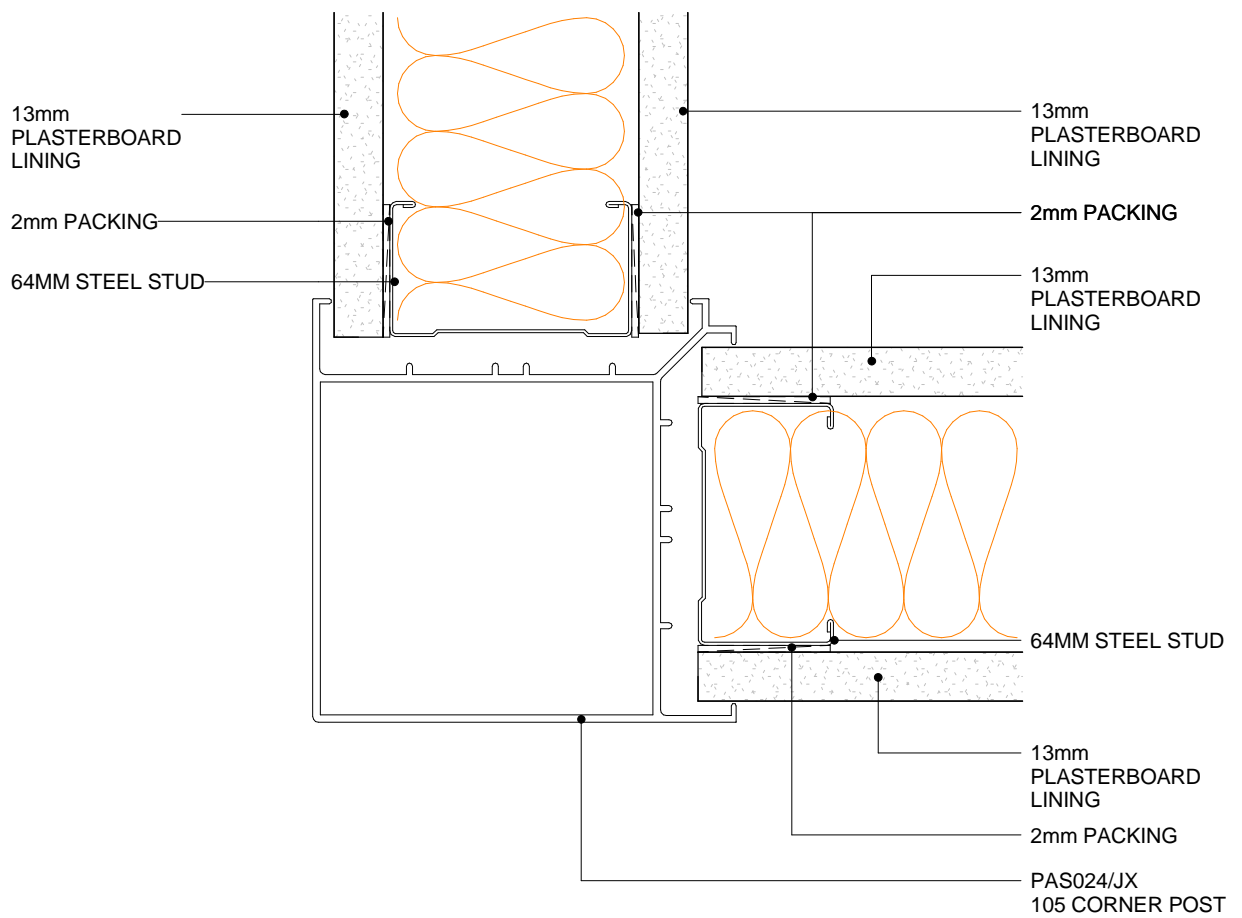

POTTER ALUMINIUM SYSTEMS
A SERIES 105 - 64MM - WALL CORNER POST
PLAN VIEW

2.5.10
 SHEET

1:2@A4
 SCALE

A 01/04/2020
 ISSUED DATE

0800 POTTER (0800 768 837) WWW.POTTERS.CO.NZ
 SUBJECT TO CHANGE WITHOUT NOTICE



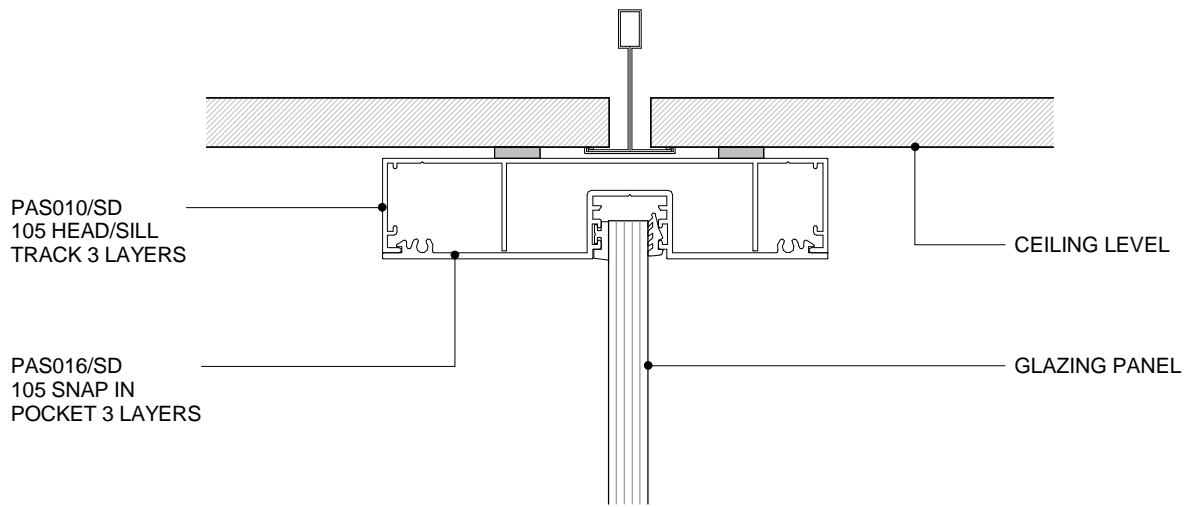

**SD TRACK 3
LAYERS**

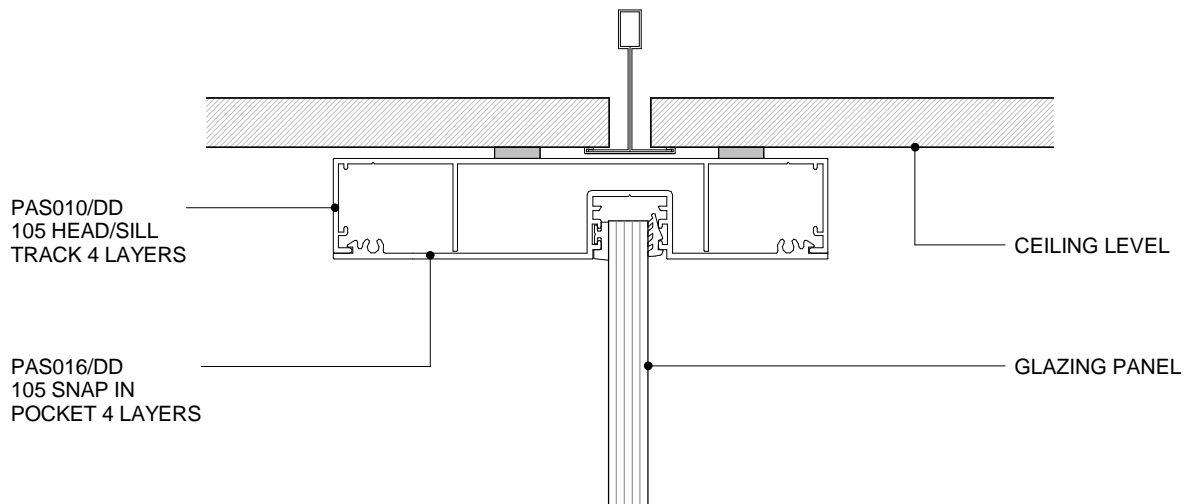

**DD TRACK 4
LAYERS**

**POTTER ALUMINIUM SYSTEMS
A SERIES 105 - 64MM - GLAZED HEADTRACK MULTI-LAYER
CROSS SECTION**

2.5.12
SHEET

1:2@A4
SCALE

A 01/04/2020
ISSUED DATE

0800 POTTER (0800 768 837) WWW.POTTERS.CO.NZ
SUBJECT TO CHANGE WITHOUT NOTICE



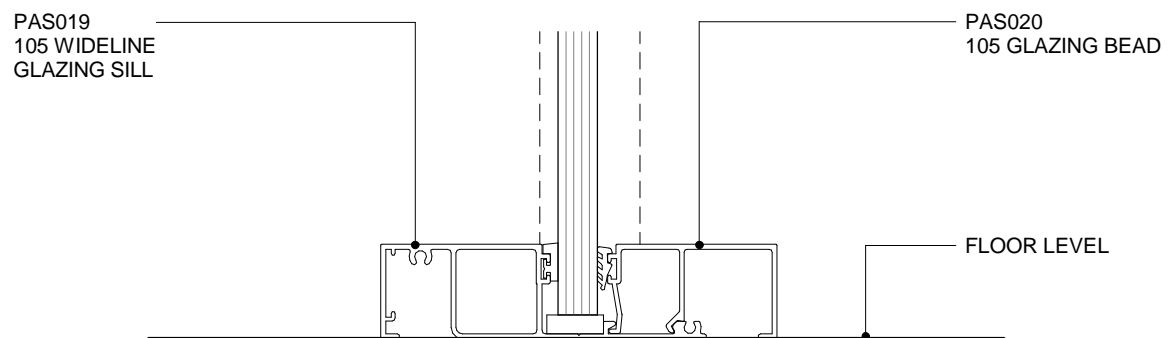
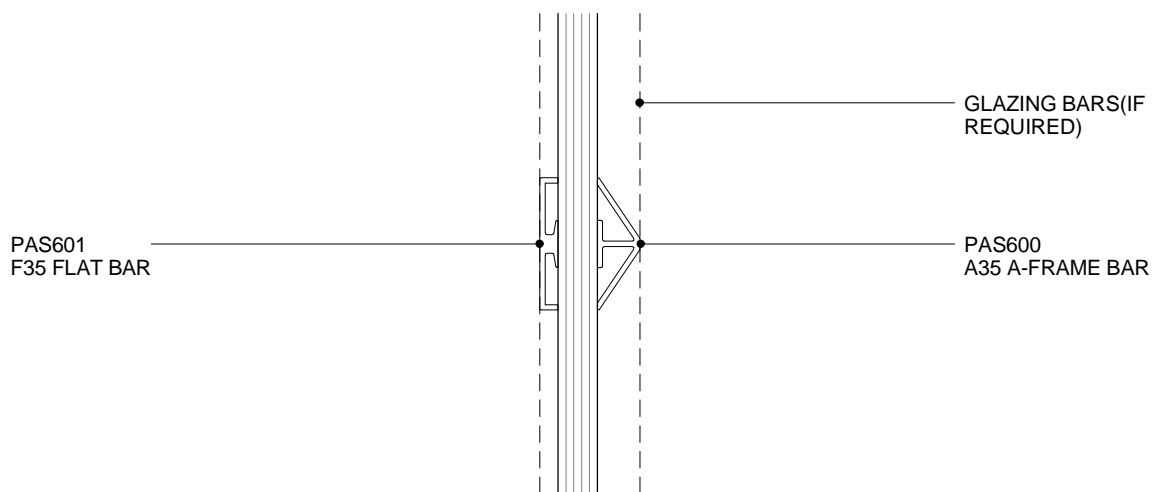
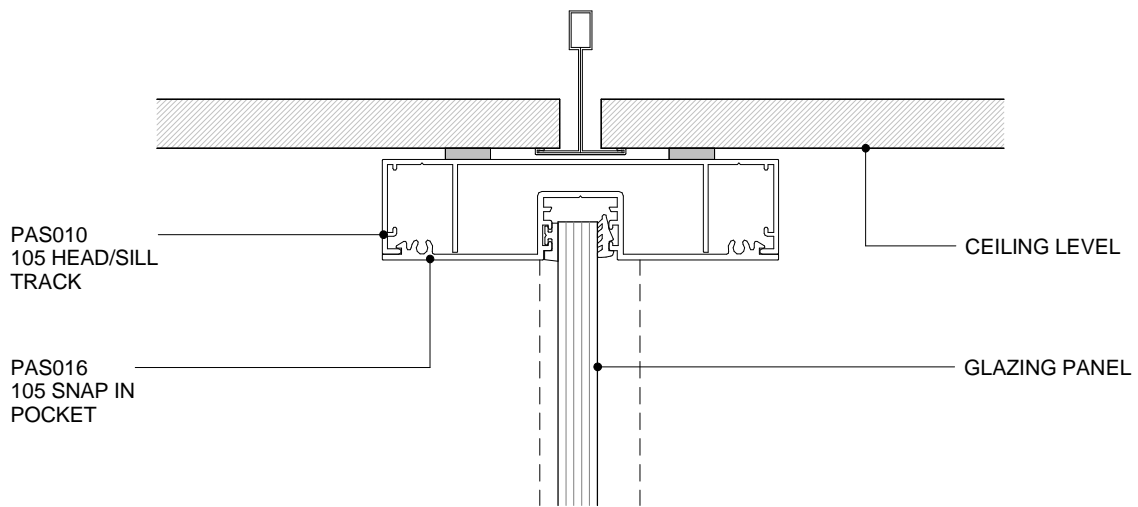

POTTER ALUMINIUM SYSTEMS
A SERIES 105 - 64MM - FULL HEIGHT GLAZING WITH GLAZING BARS
CROSS SECTION

2.5.13

SHEET

1:2@A4
SCALE

A 01/04/2020
ISSUED DATE

0800 POTTER (0800 768 837) WWW.POTTERS.CO.NZ
SUBJECT TO CHANGE WITHOUT NOTICE



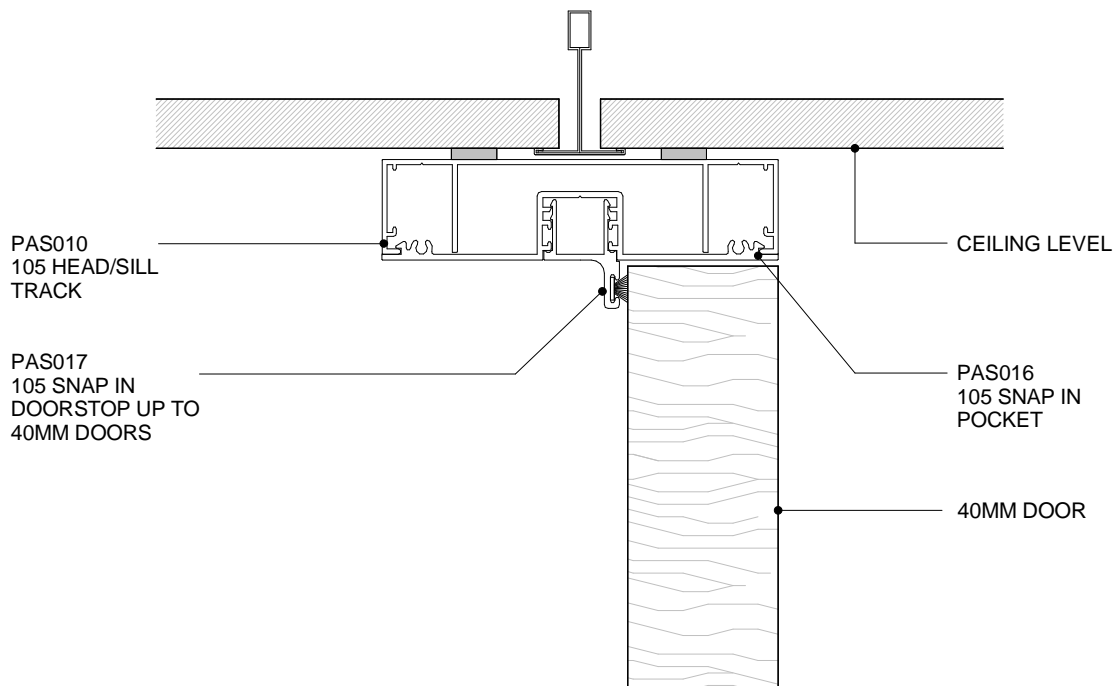
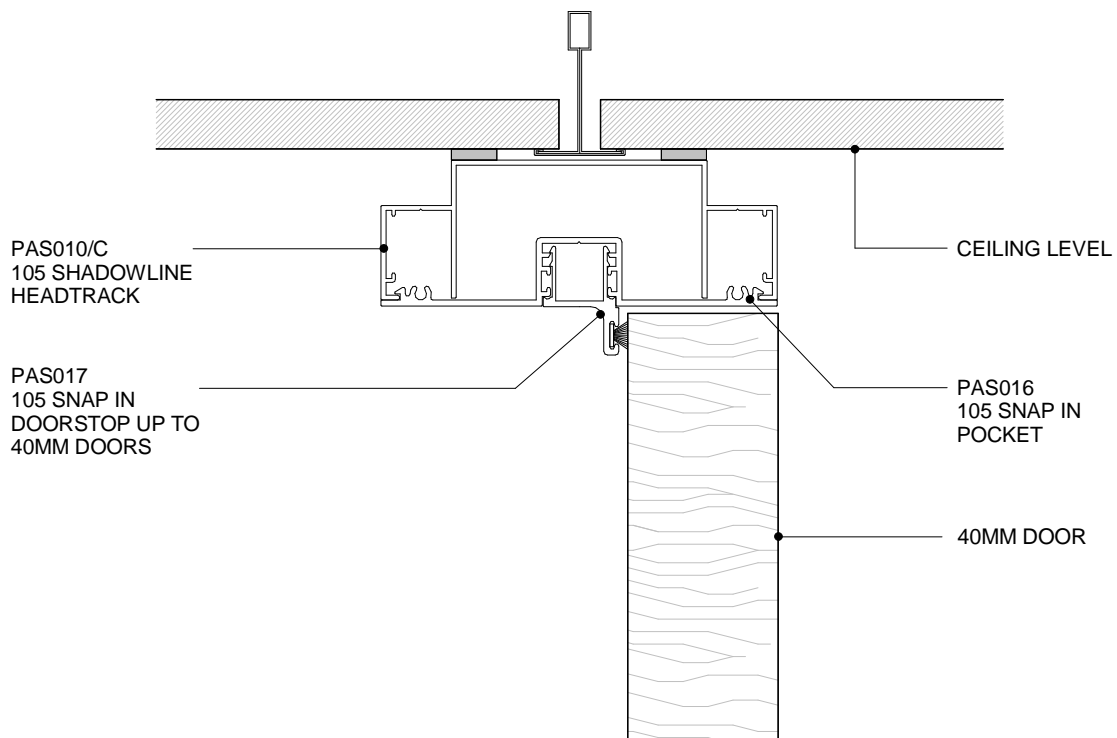

POTTER ALUMINIUM SYSTEMS
A SERIES 105 - 64MM - 40MM DOOR HEADTRACK DETAILS
CROSS SECTION

2.6.1
SHEET

1:2@A4
SCALE

A 01/04/2020
ISSUED DATE

0800 POTTER (0800 768 837) WWW.POTTERS.CO.NZ
 SUBJECT TO CHANGE WITHOUT NOTICE



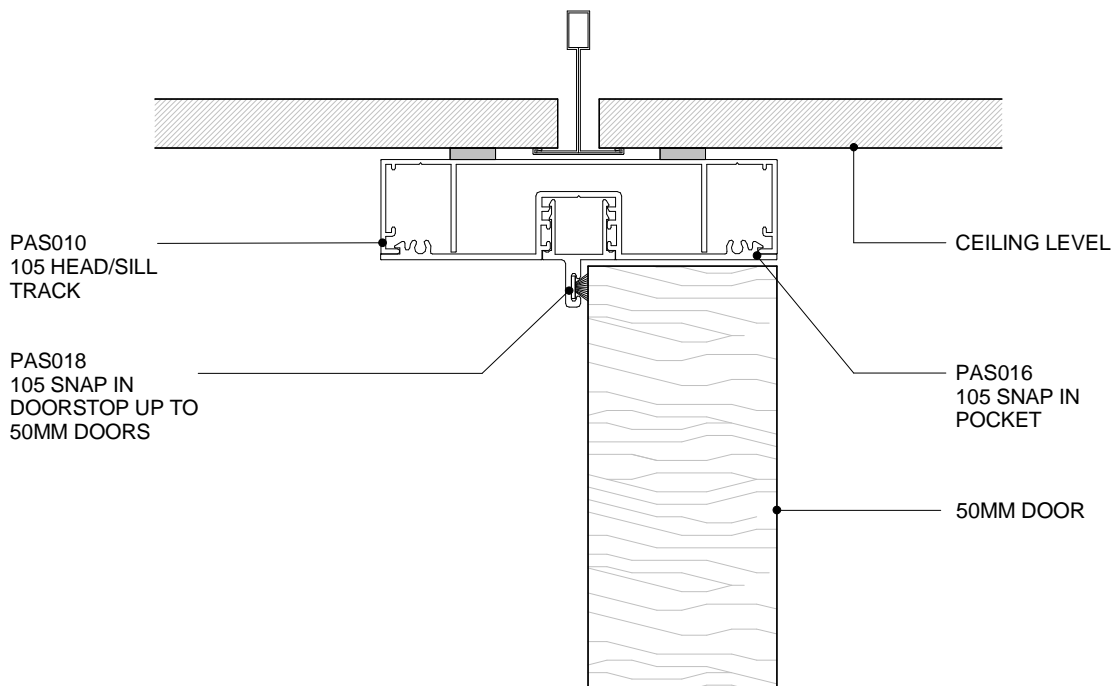
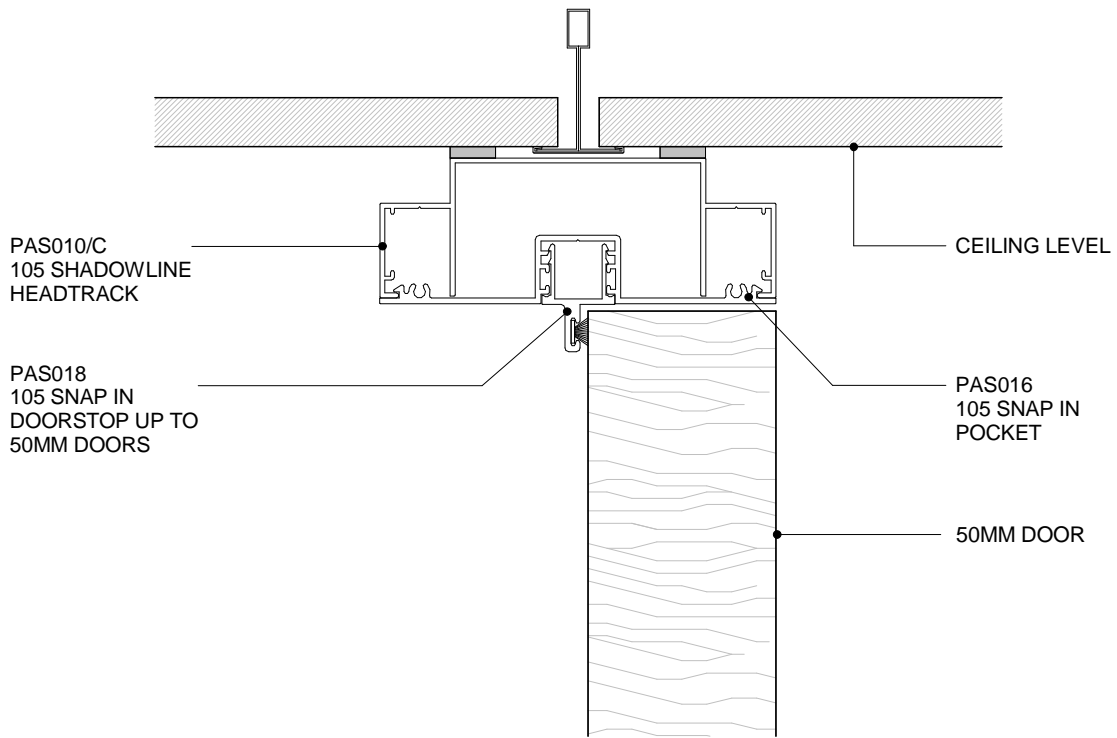

POTTER ALUMINIUM SYSTEMS
A SERIES 105 - 64MM - 50MM DOOR HEADTRACK DETAILS
CROSS SECTION

2.6.2
SHEET

1:2@A4
SCALE

A 01/04/2020
ISSUED DATE

0800 POTTER (0800 768 837) WWW.POTTERS.CO.NZ
SUBJECT TO CHANGE WITHOUT NOTICE



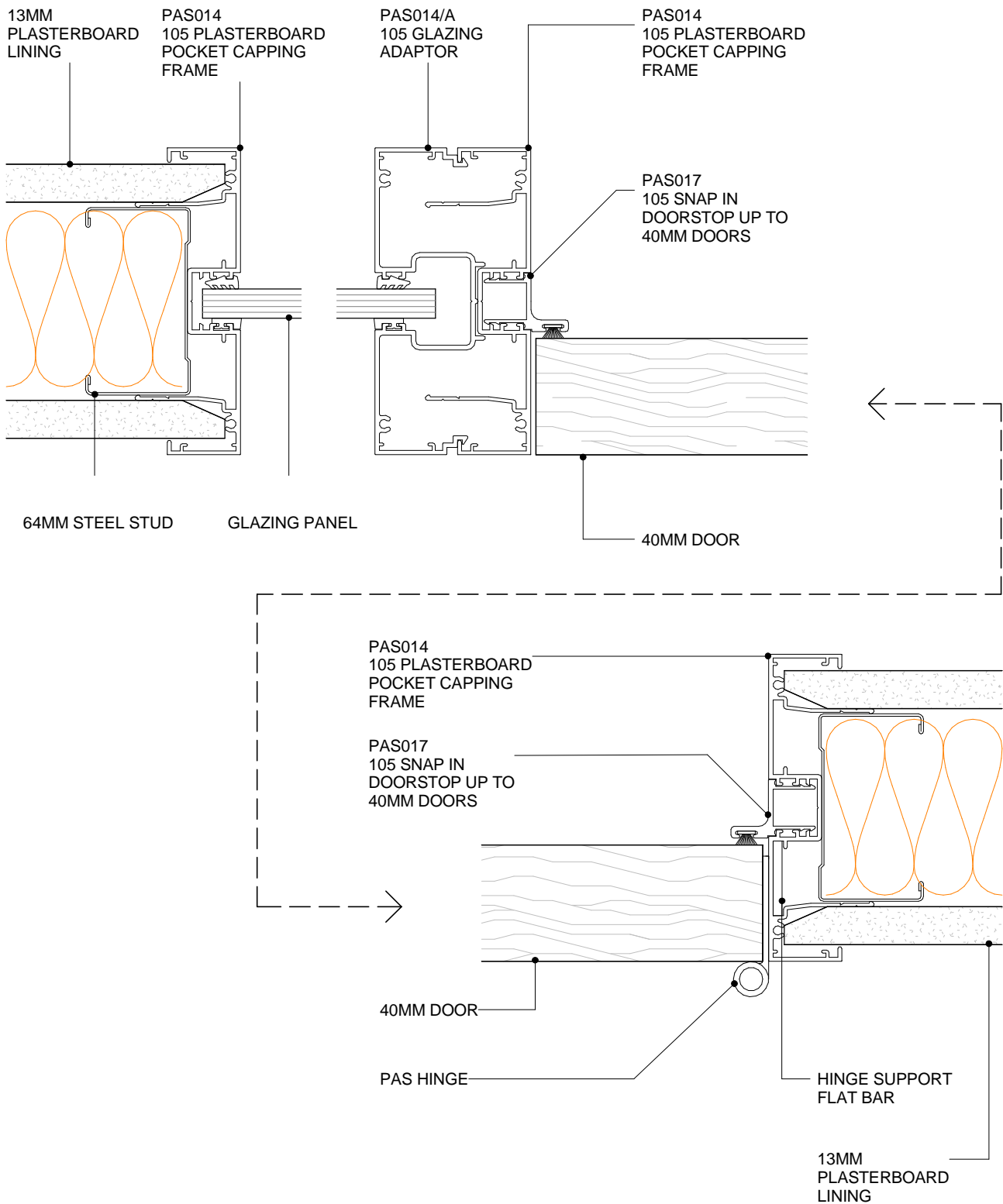

POTTER ALUMINIUM SYSTEMS
A SERIES 105 - 64MM - 40MM DOOR TO HEADTRACK
PLAN VIEW

2.6.3
SHEET

1:2@A4
SCALE

A 01/04/2020
ISSUED DATE

0800 POTTER (0800 768 837) WWW.POTTERS.CO.NZ
SUBJECT TO CHANGE WITHOUT NOTICE



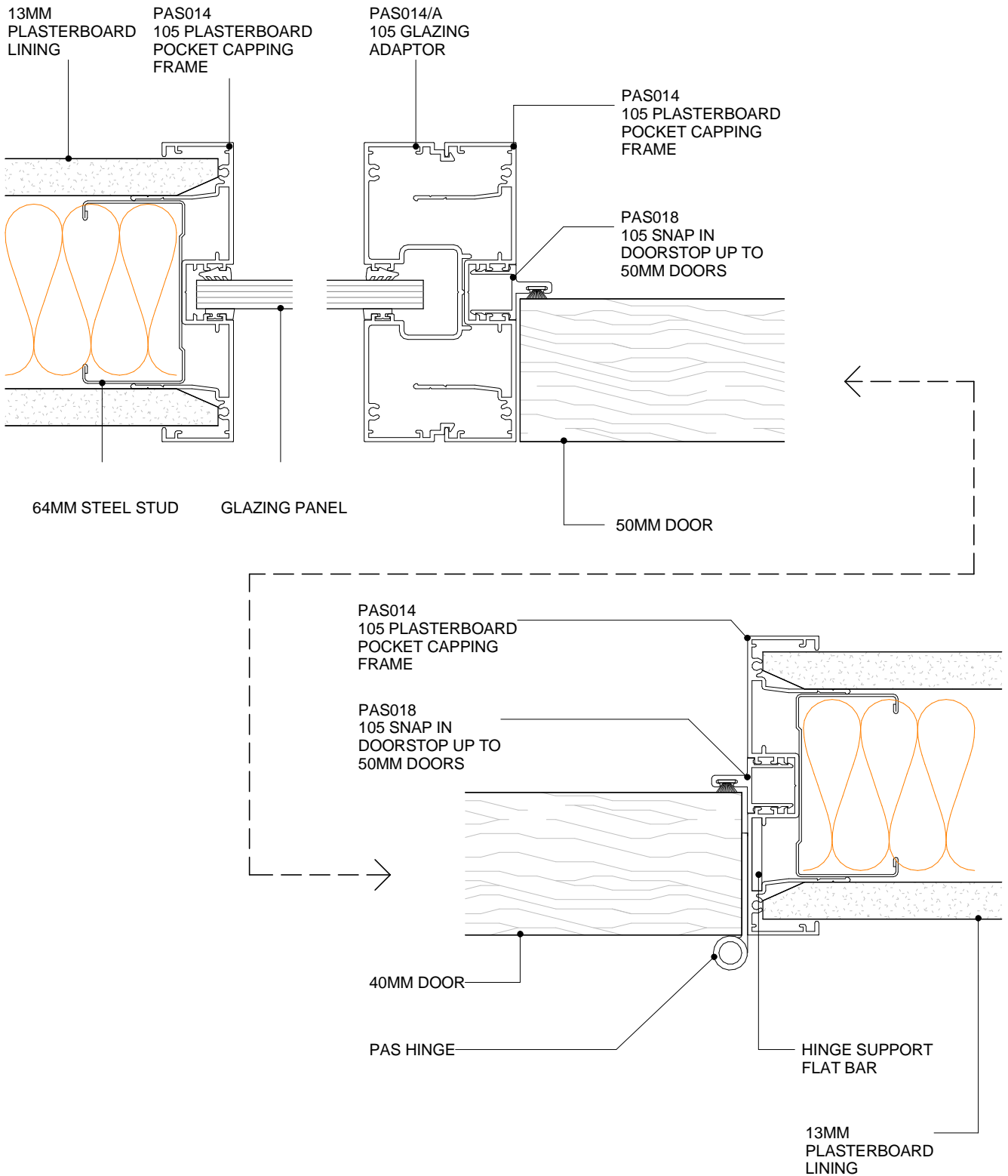

POTTER ALUMINIUM SYSTEMS
A SERIES 105 - 64MM - 50MM DOOR TO HEADTRACK
PLAN VIEW

2.6.4
SHEET

1:2@A4
SCALE

A 01/04/2020
ISSUED DATE

0800 POTTER (0800 768 837) WWW.POTTERS.CO.NZ
SUBJECT TO CHANGE WITHOUT NOTICE



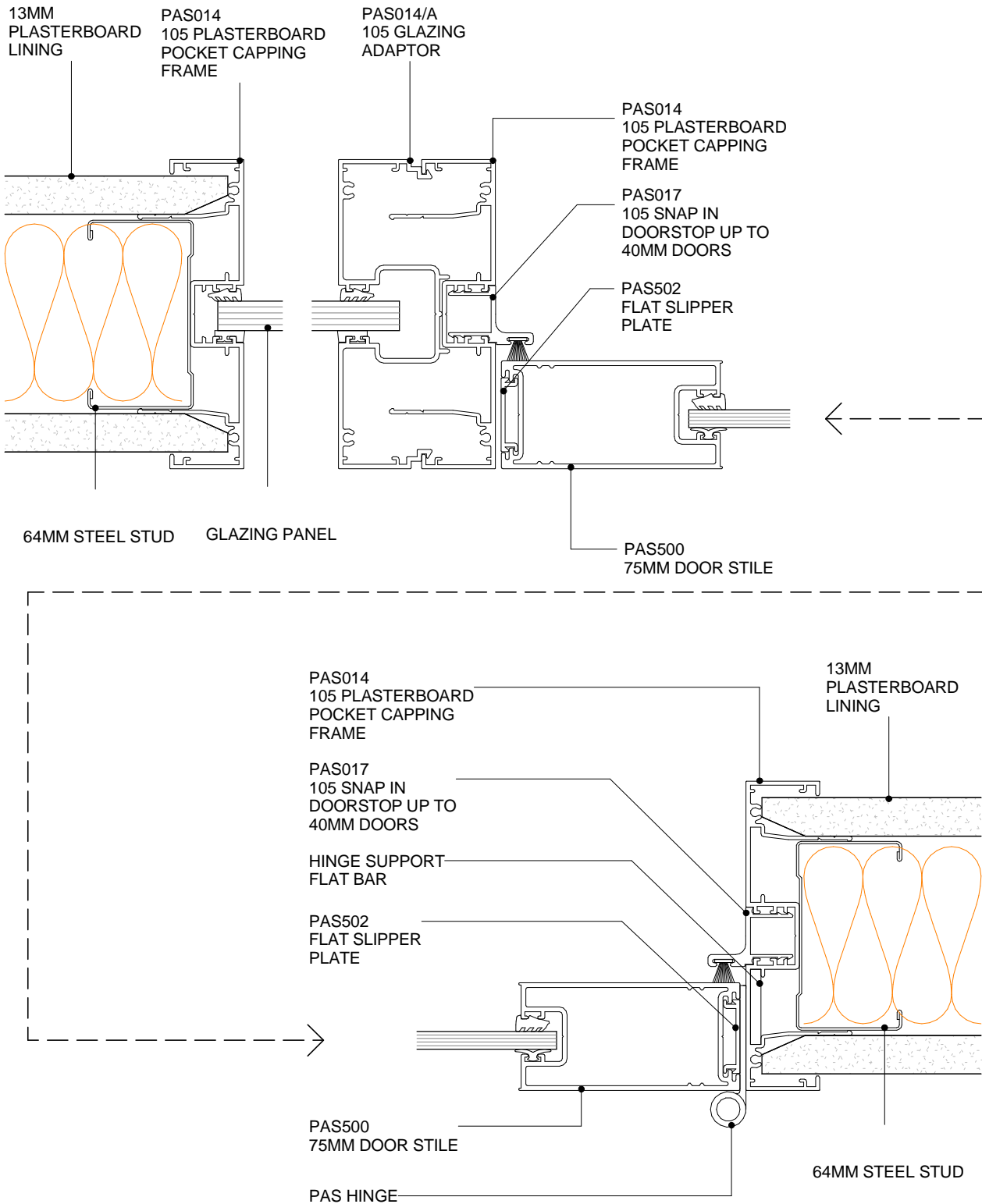

POTTER ALUMINIUM SYSTEMS
A SERIES 105 - 64MM - 50MM MULLION & DS SERIES 75MM DOOR
PLAN VIEW

2.6.5
SHEET

1:2@A4
SCALE

A 01/04/2020
ISSUED DATE

0800 POTTER (0800 768 837) WWW.POTTERS.CO.NZ
SUBJECT TO CHANGE WITHOUT NOTICE



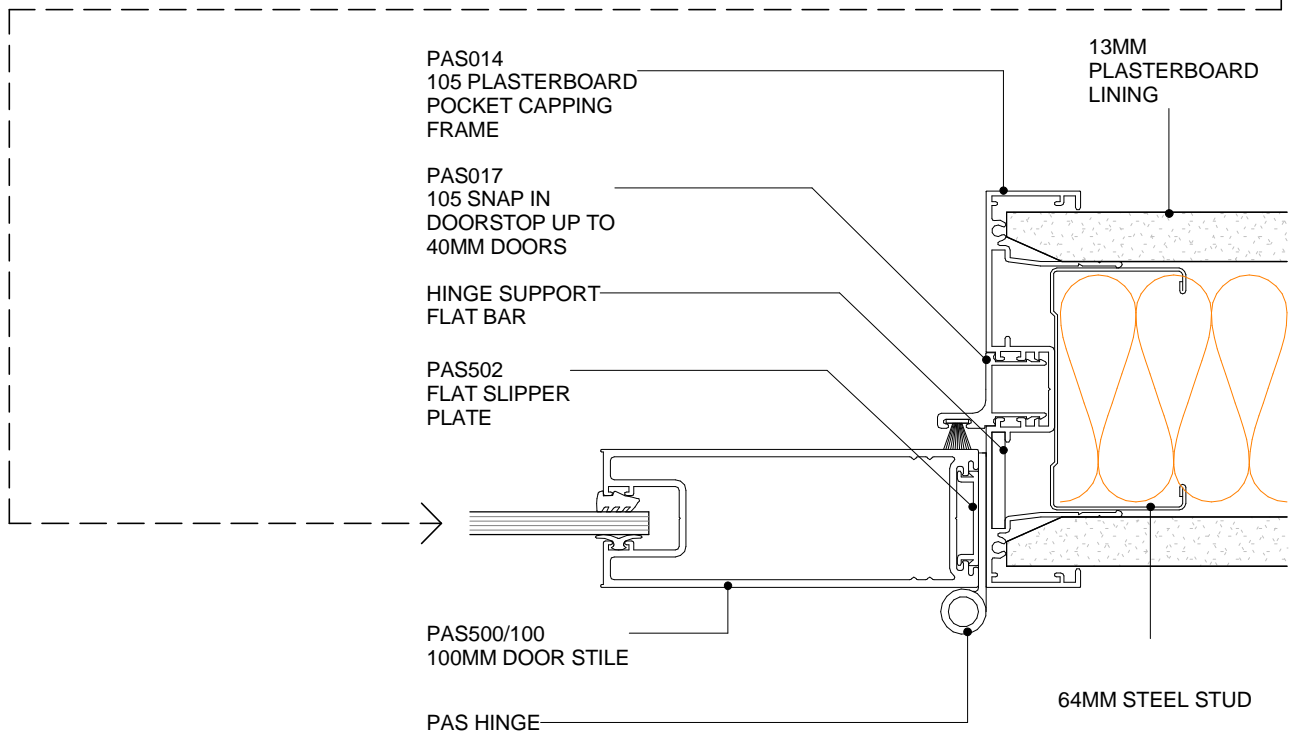
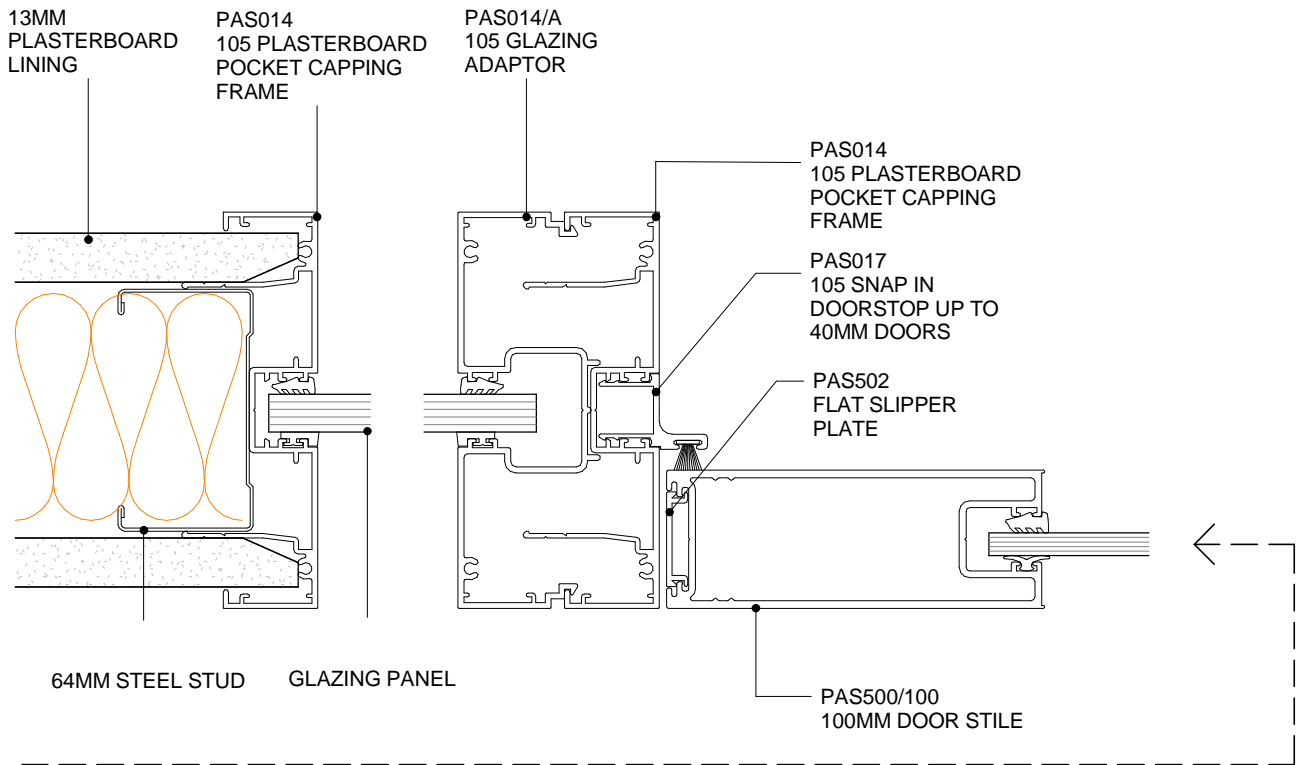

POTTER ALUMINIUM SYSTEMS
A SERIES 105 - 64MM - 50MM MULLION & DS SERIES 100MM DOOR
PLAN VIEW

2.6.6
SHEET

1:2@A4
SCALE

A 01/04/2020
ISSUED DATE

0800 POTTER (0800 768 837) WWW.POTTERS.CO.NZ
SUBJECT TO CHANGE WITHOUT NOTICE



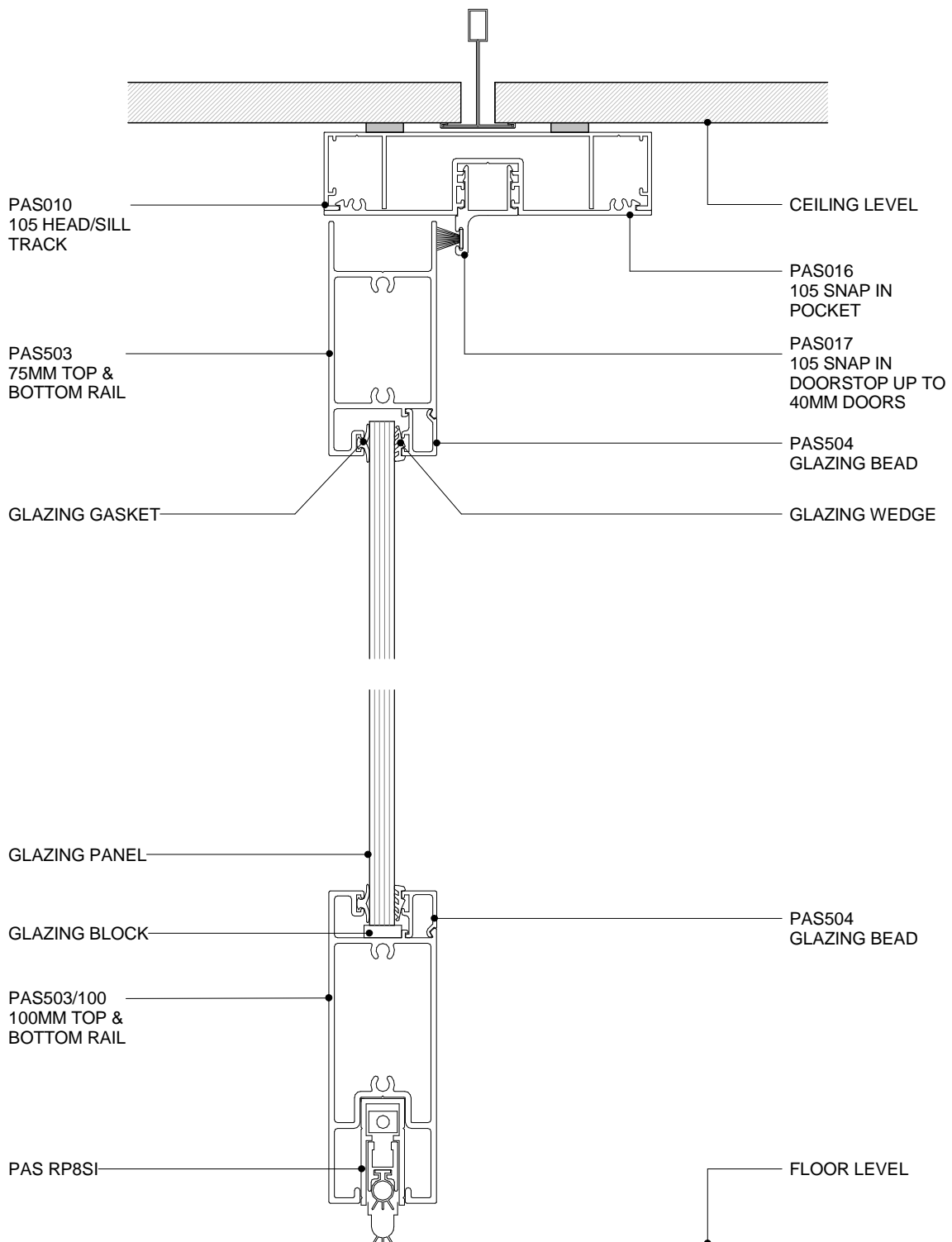

POTTER ALUMINIUM SYSTEMS
A SERIES 105 - 64MM - DS SERIES 100MM DOOR & RP8SI DOOR SEAL
CROSS SECTION

2.6.7
SHEET

1:2@A4
SCALE

A 01/04/2020
ISSUED DATE

0800 POTTER (0800 768 837) WWW.POTTERS.CO.NZ
SUBJECT TO CHANGE WITHOUT NOTICE



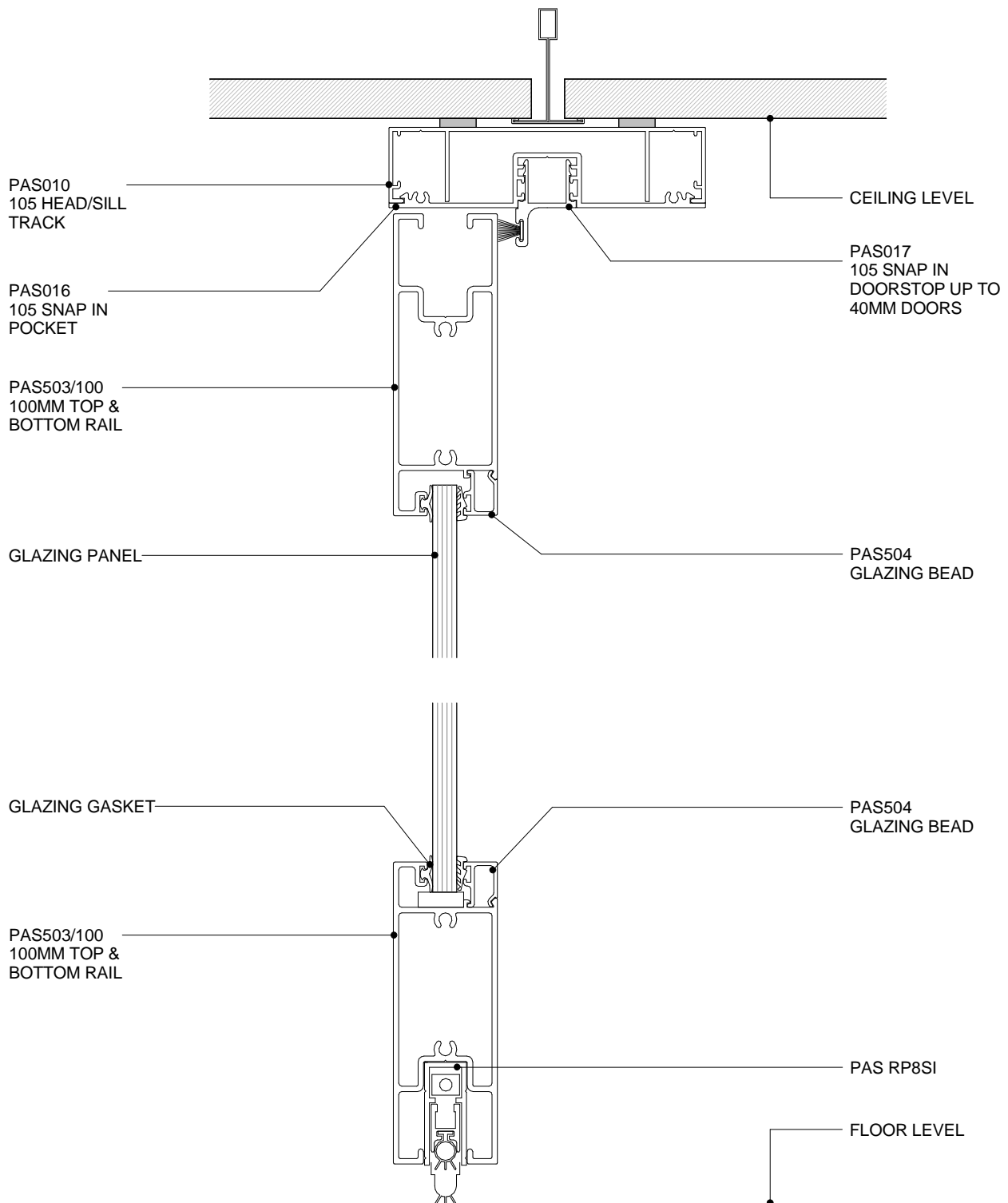

POTTER ALUMINIUM SYSTEMS
A SERIES 105 - 64MM - DS SERIES 100MM DOOR & RP8SI DOOR SEAL
CROSS SECTION

2.6.8
SHEET

1:2@A4
SCALE

A 01/04/2020
ISSUED DATE

0800 POTTER (0800 768 837) WWW.POTTERS.CO.NZ
SUBJECT TO CHANGE WITHOUT NOTICE



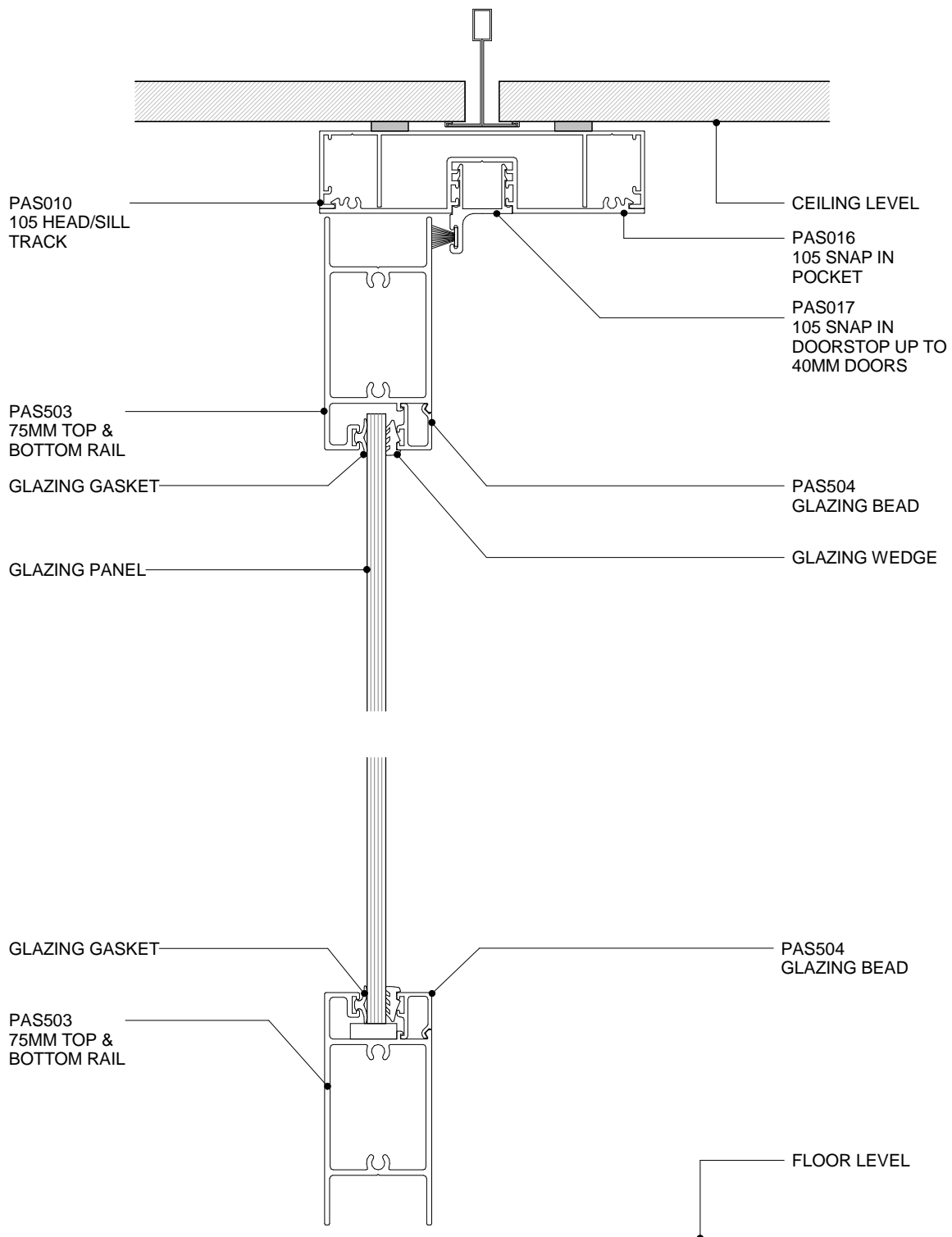

POTTER ALUMINIUM SYSTEMS
A SERIES 105 - 64MM - DS SERES 75MM DOOR
CROSS SECTION

2.6.9
 SHEET

1:2@A4
 SCALE

A 01/04/2020
 ISSUED DATE

0800 POTTER (0800 768 837) WWW.POTTERS.CO.NZ
 SUBJECT TO CHANGE WITHOUT NOTICE



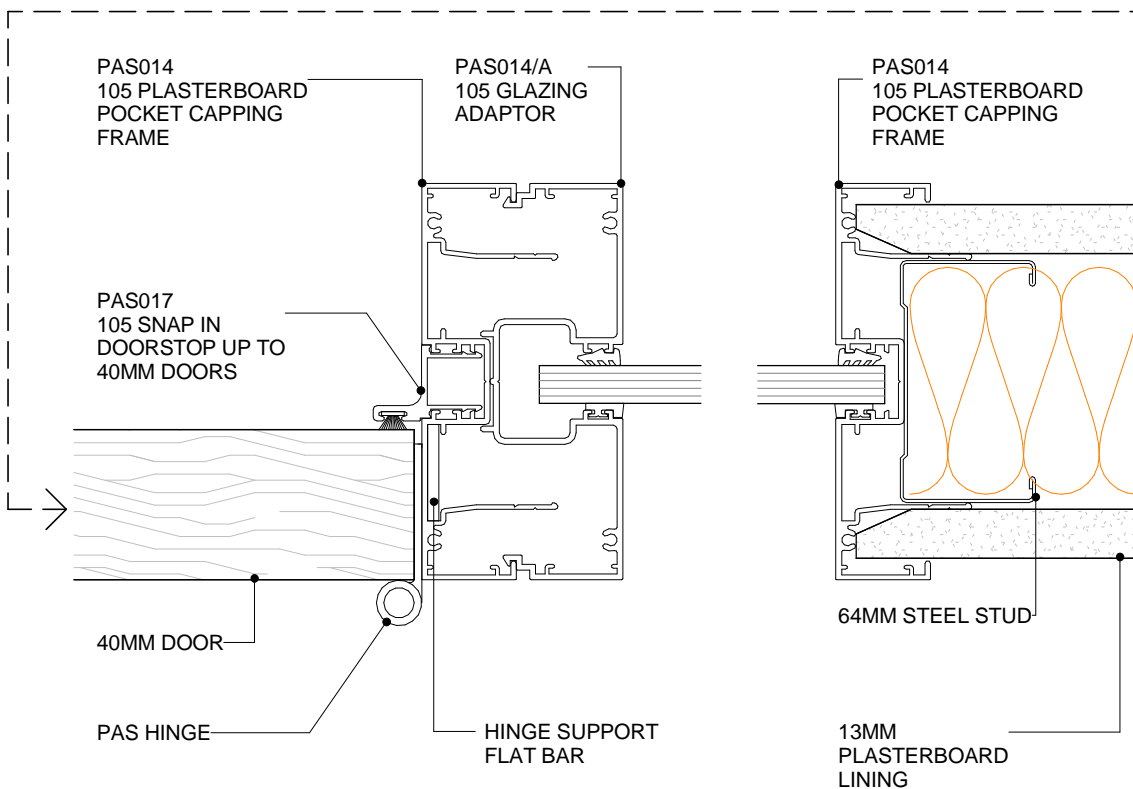
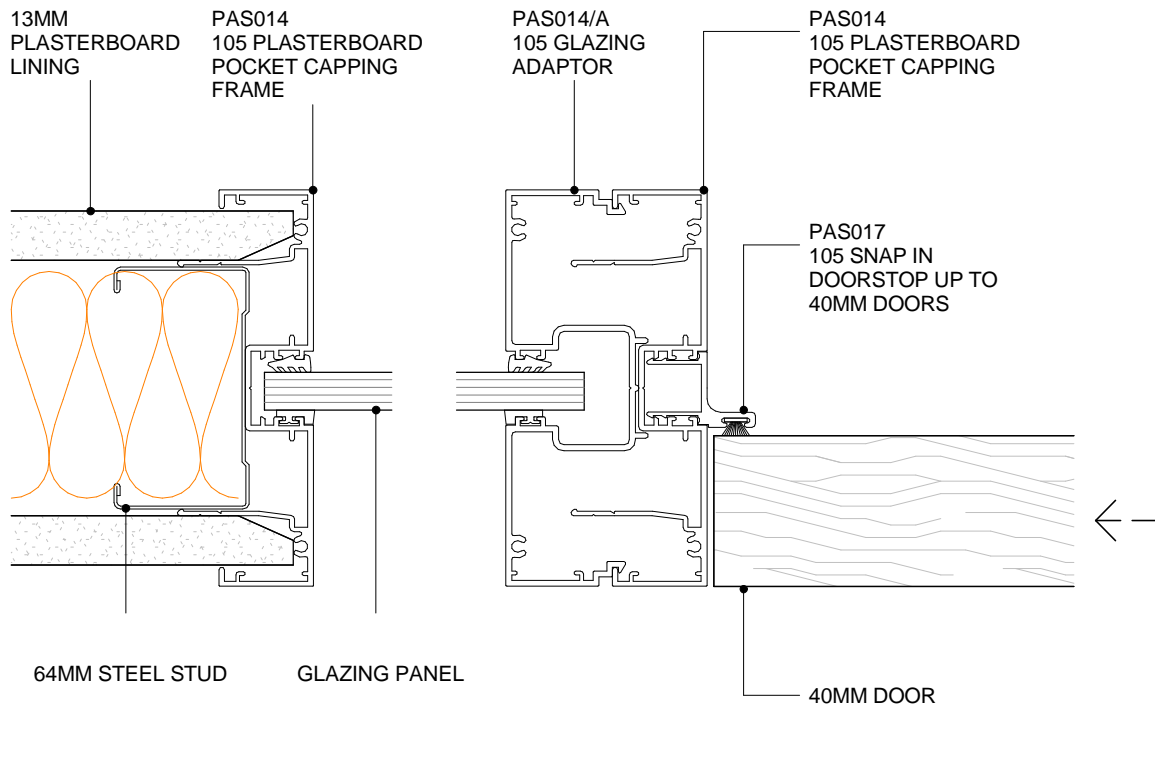

POTTER ALUMINIUM SYSTEMS
A SERIES 105 - 64MM - TWIN MULLIONS AND SIDELIGHTS
PLAN VIEW

2.6.10
SHEET

1:2@A4
SCALE

A 01/04/2020
ISSUED DATE

0800 POTTER (0800 768 837) WWW.POTTERS.CO.NZ
SUBJECT TO CHANGE WITHOUT NOTICE

CSR

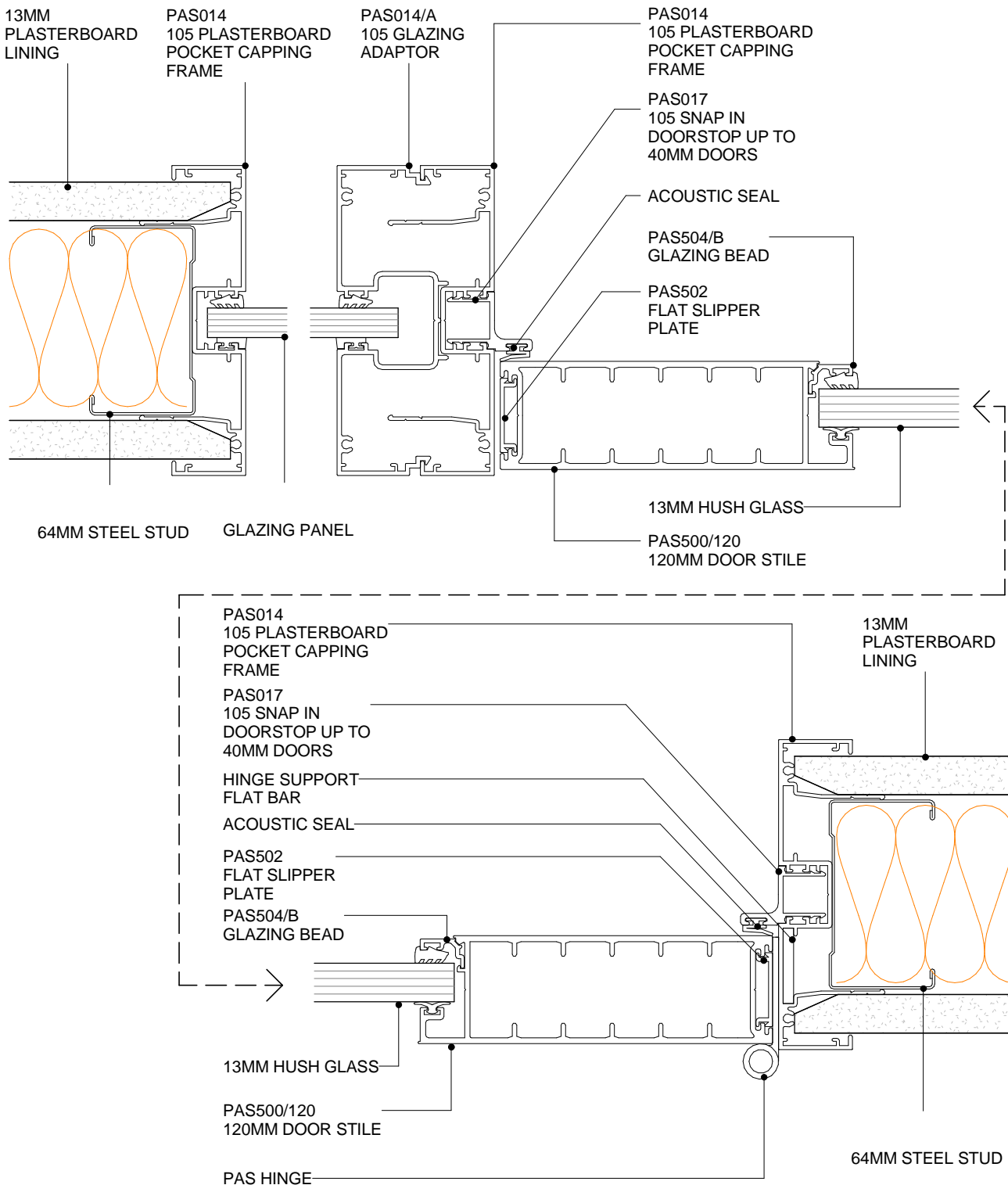

POTTER ALUMINIUM SYSTEMS
A SERIES 105 - 64MM - 50MM MULLION & DS SERIES 120MM DOOR
PLAN VIEW

2.6.11
SHEET

1:2@A4
SCALE

A 01/04/2020
ISSUED DATE

0800 POTTER (0800 768 837) WWW.POTTERS.CO.NZ
SUBJECT TO CHANGE WITHOUT NOTICE



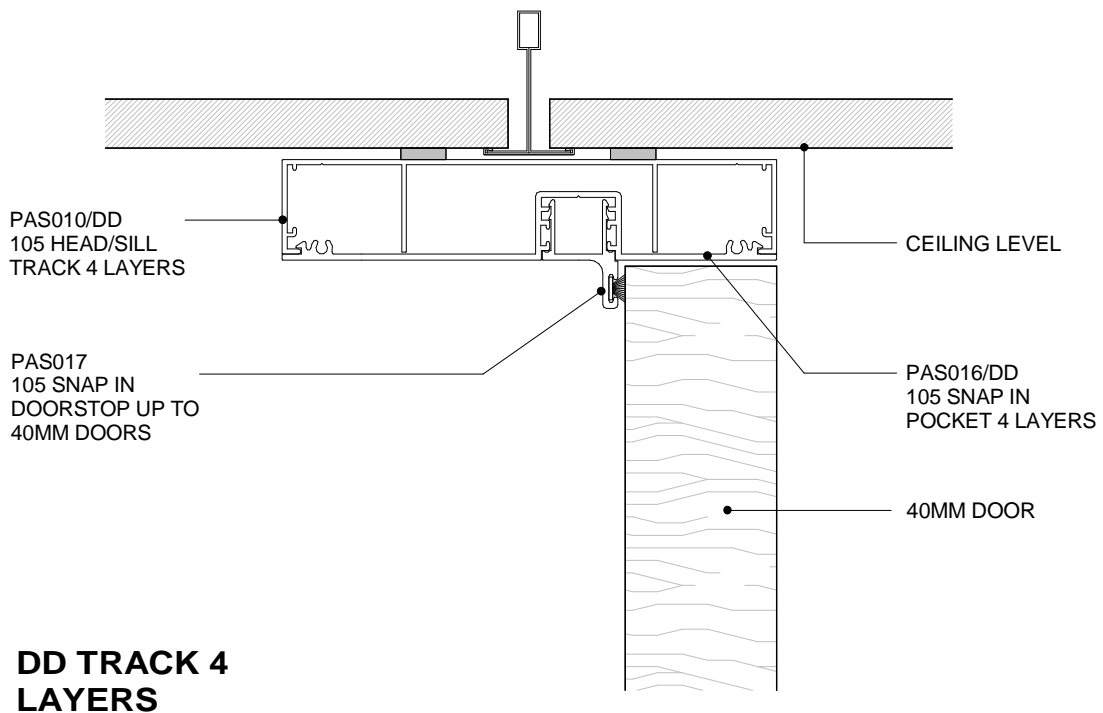
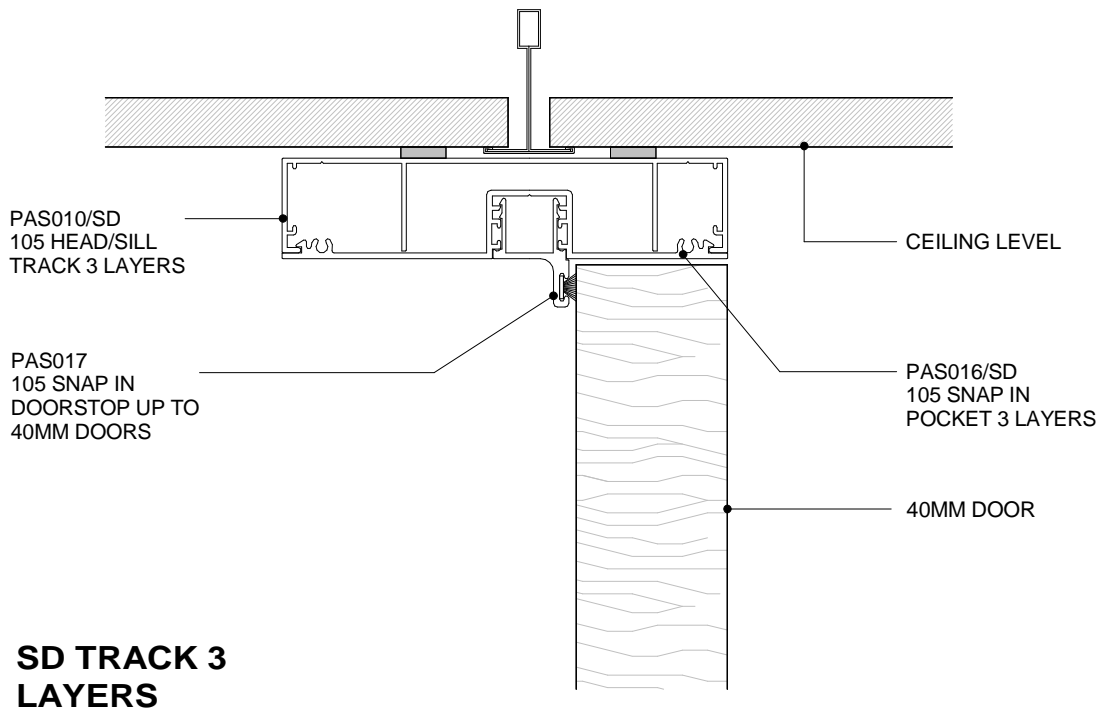

**POTTER ALUMINIUM SYSTEMS
A SERIES 105 - 64MM - 40MM DOOR HEADTRACK MULTI-LAYER
CROSS SECTION**

2.6.12
SHEET

1:2@A4
SCALE

A 01/04/2020
ISSUED DATE

0800 POTTER (0800 768 837) WWW.POTTERS.CO.NZ
SUBJECT TO CHANGE WITHOUT NOTICE



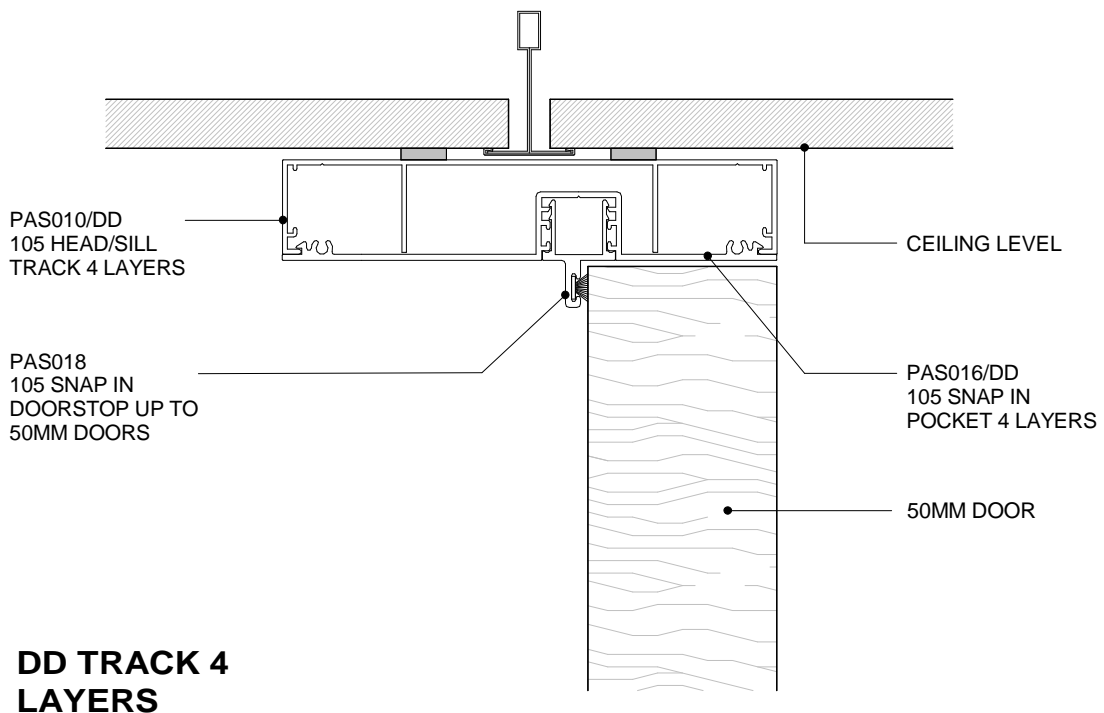
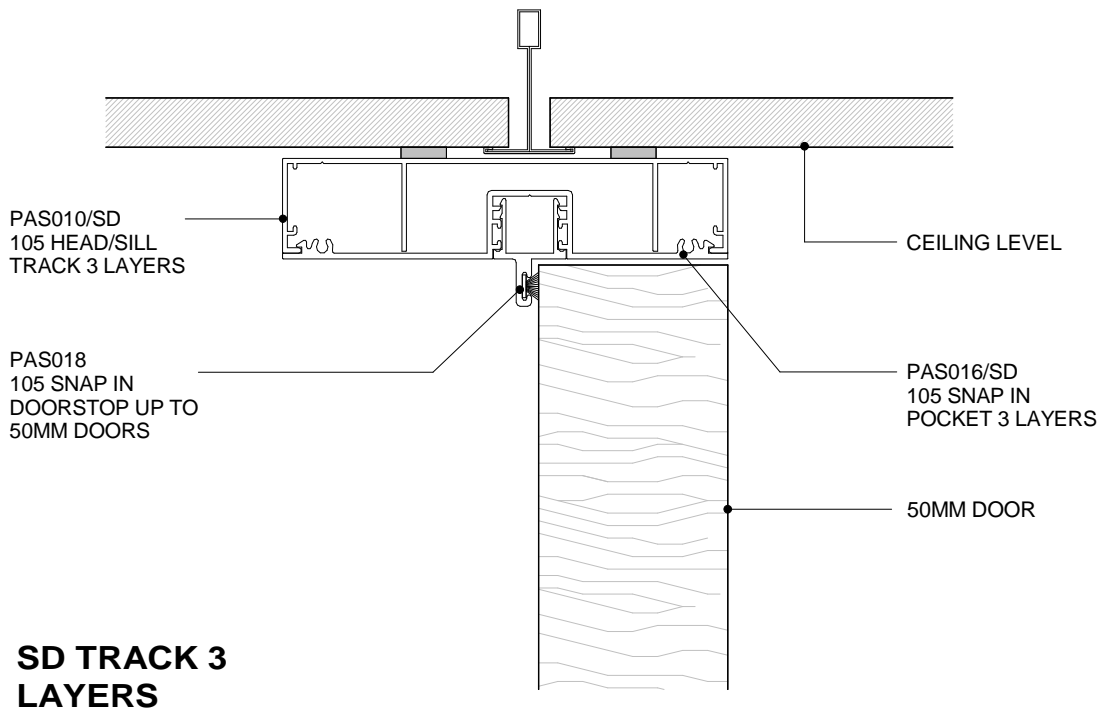

**POTTER ALUMINIUM SYSTEMS
A SERIES 105 - 64MM - 50MM DOOR HEADTRACK MULTI-LAYER
CROSS SECTION**

2.6.13
SHEET

1:2@A4
SCALE

A 01/04/2020
ISSUED DATE

0800 POTTER (0800 768 837) WWW.POTTERS.CO.NZ
SUBJECT TO CHANGE WITHOUT NOTICE

