

## 5.1 - DS Series

### Suite overview

#### DS Series Doors

Designed to fit with Potter aluminium systems

- Available in 38mm thick doors only.
- Styles and rails sizes 75mm and 100mm. Mid rails 45mm and 75mm.
- Can accommodate glass thicknesses of 10.38mm thick laminated glass.

#### DS Series Sliders

Designed to fit with Potter aluminium systems, available in numerous configurations based around the 38mm Door series.

### Specification

The Masterspec branded section 5211PP POTTER ALUMINIUM INTERNAL PARTITIONS is available for download from the following resources.

[www.masterspec.co.nz](http://www.masterspec.co.nz)

[www.potters.co.nz](http://www.potters.co.nz)

[www.eboss.co.nz](http://www.eboss.co.nz)

[www.productspec.co.nz](http://www.productspec.co.nz)

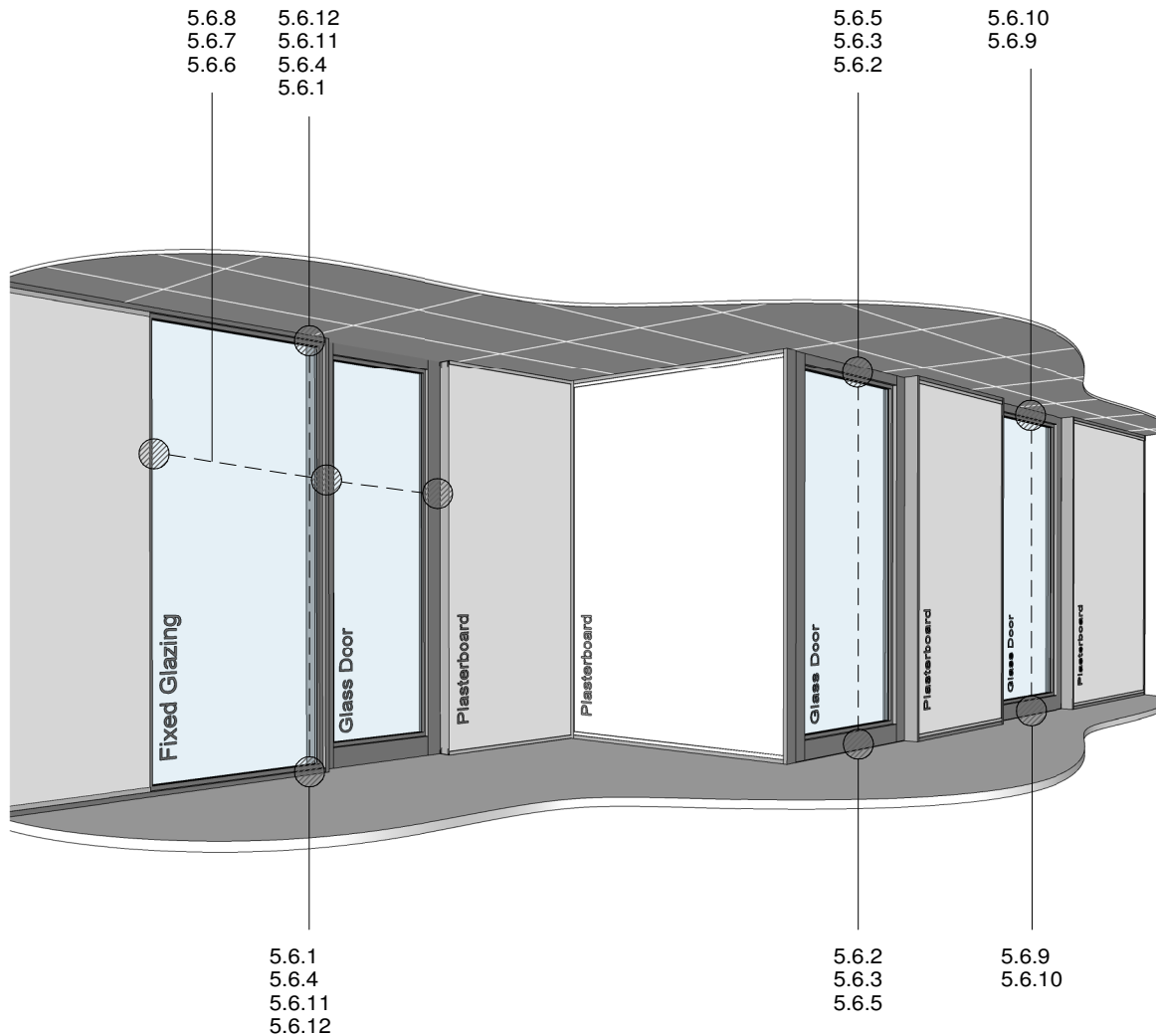
**TIPS FOR ARCHITECTS AND DESIGNERS:  
 TYPICAL FOR ALL SUITES**

- 6MM - 12.38MM MAXIMUM LAMINATED GLASS SIZE
- 13MM PLASTERBOARD ONLY
- 105MM PROFILES = 64MM STUD
- 132MM PROFILES = 92MM STUD
- FOR SOUND TRANSMISSION CLASS POINTS (STC) REFER TO THE POTTERS WEBSITE [WWW.POTTERS.CO.NZ](http://WWW.POTTERS.CO.NZ) IN THE "PARTITIONING" SECTION

| TYPE OF GLASS          | THICKNESS GRADE A | MAXIMUM AREA M <sup>2</sup> | SYSTEM TYPE |
|------------------------|-------------------|-----------------------------|-------------|
| TOUGHENED SAFETY GLASS | 6MM               | 4.0                         | 75MM        |
| TOUGHENED SAFETY GLASS | 8MM               | 6.0                         | 100MM       |
| LAMINATED SAFETY GLASS | 6MM               | 3.0                         | 75MM        |
| LAMINATED SAFETY GLASS | 8MM               | 5.0                         | 100MM       |

**POTTER ALUMINIUM SYSTEMS  
 DS SERIES DETAIL REFERENCES**
**5.2.1**  
 SHEET

SCALE

 10/01/2011  
 ISSUED DATE

 0800 POTTER (0800 768 837) [WWW.POTTERS.CO.NZ](http://WWW.POTTERS.CO.NZ)  
 DETAILS SUBJECT TO CHANGE WITHOUT NOTICE

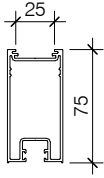
**PAS500**  
75MM DOOR STILE

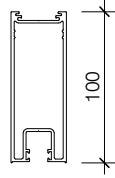

**PAS500/100**  
100MM DOOR STILE



**PAS501**  
SLIDE ACOUSTIC  
SLIPPER PLATE



**PAS502**  
FLAT SLIPPER PLATE

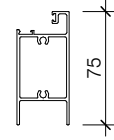

**PAS503**  
75MM TOP & BOTTOM  
RAIL

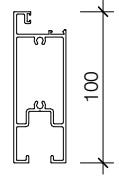

**PAS503/100**  
100MM TOP &  
BOTTOM RAIL



**PAS504**  
GLAZING BEAD



**PAS506**  
FRONT ACOUSTIC  
SLIPPER PLATE

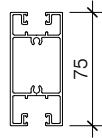

**PAS505**  
75MM MID RAIL

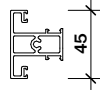

**PAS505/45**  
45MM MID RAIL



**PAS508**  
BOTTOM ROLLER  
TRACK



**PAS507**  
INTERNAL GUIDE

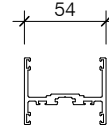

**PAS520**  
SLIDING DOOR  
LOCATING FRAME

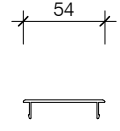

**PAS521**  
SLIDING DOOR  
FRAME



**PAS522/CS**  
CS SLIDING DOOR  
TRACK

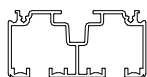

**PAS522/CSD**  
CS DOUBLE SLIDING  
DOOR FRAME

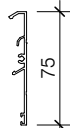

**PAS523/CS**  
CS SLIDING DOOR  
PELMET

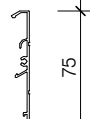

**PAS523/CSF**  
CS FLUSH SLIDING  
DOOR PELMET

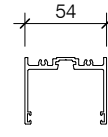

**PAS524**  
SLIDING DOOR TOP  
GUIDE

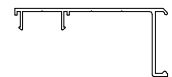

**PAS530**  
STARTING FRAME



**PAS531**  
PELMET

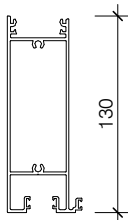

**PAS532**  
GLAZING RAIL

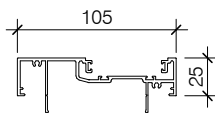

**PAS533**  
DOOR STOP FRAME



**PAS534**  
PELMET CAP



**M6/M8**  
CS ROLLER PACK  
M6/90KG M8/240KG



**200kg Bottom**  
ROLLER PACK

**POTTER ALUMINIUM SYSTEMS  
DS SERIES STANDARD SUITE PROFILES**

**5.3.1**  
SHEET

1 : 5 @ A4  
SCALE

10/01/2011  
ISSUED DATE

0800 POTTER (0800 768 837) WWW.POTTERS.CO.NZ  
DETAILS SUBJECT TO CHANGE WITHOUT NOTICE



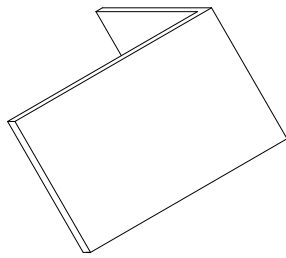

STAKE/1

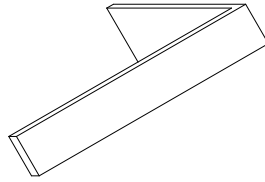

STAKE/3

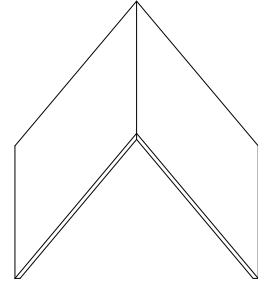

STAKE/4

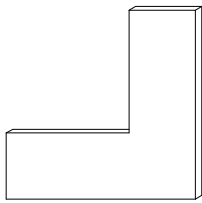

STAKE/6



STAKE/7



PVC SKIRTING INFILL

 UNIVERSAL  
 JAMBSEAL

JAMBSEAL INFILL

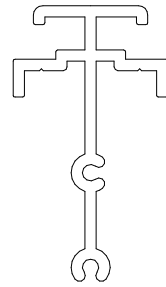
 ACE CAPTIVE  
 WEDGE

 GLAZING POST  
 SPIGOT

**POTTER ALUMINIUM SYSTEMS  
 DS SERIES ACCESSORIES**
**5.3.2**  
 SHEET

 1 : 2 @ A4  
 SCALE

 10/01/2011  
 ISSUED DATE

 0800 POTTER (0800 768 837) WWW.POTTERS.CO.NZ  
 DETAILS SUBJECT TO CHANGE WITHOUT NOTICE

**CSR**

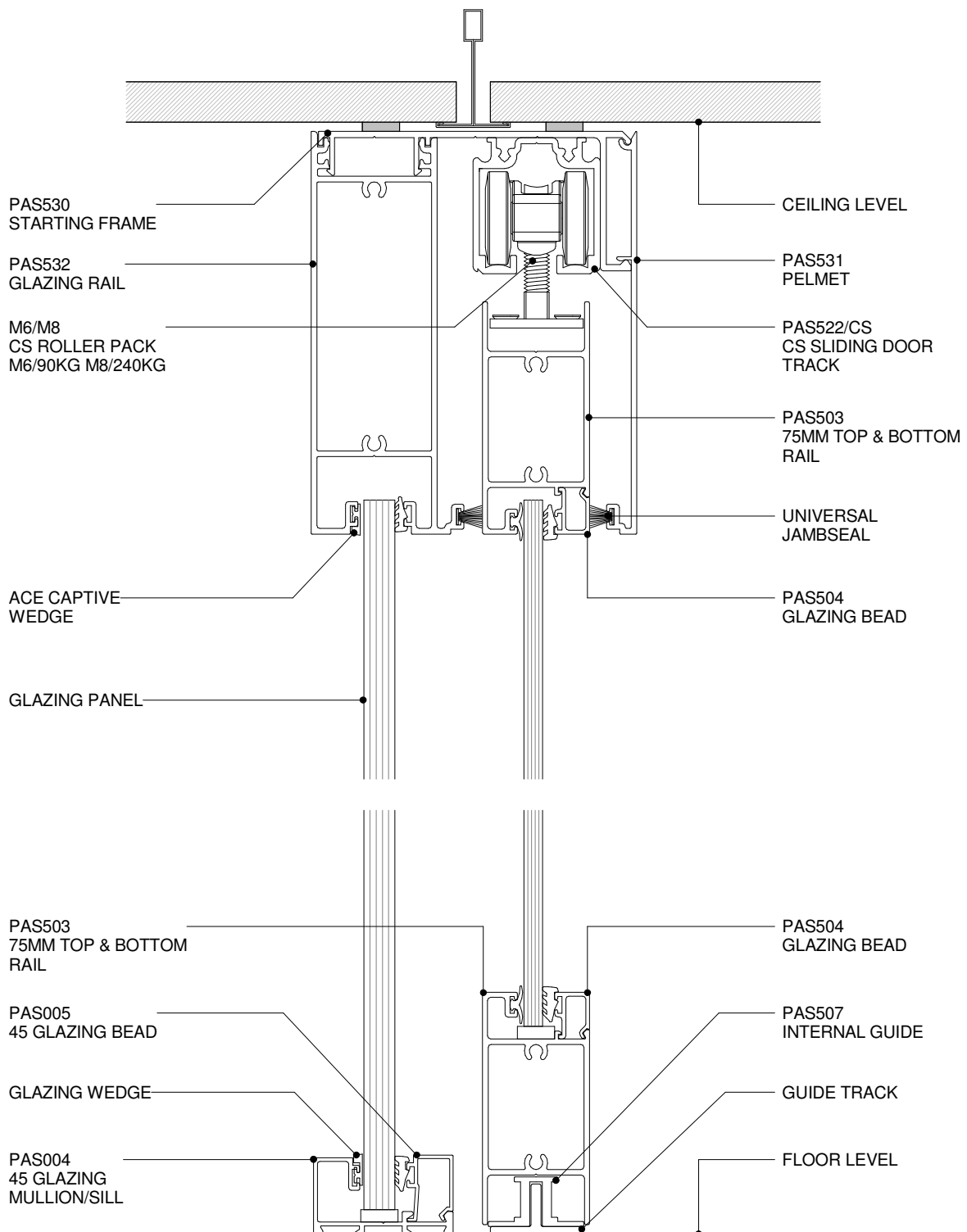
**POTTER ALUMINIUM SYSTEMS**  
**DS SERIES - 130 SLIDER - 75MM DOOR & GLAZING**  
**CROSS SECTION**
**5.6.1**

SHEET

 1 : 2 @ A4  
 SCALE

 10/01/2011  
 ISSUED DATE

 0800 POTTER (0800 768 837) WWW.POTTERS.CO.NZ  
 DETAILS SUBJECT TO CHANGE WITHOUT NOTICE

**CSR**

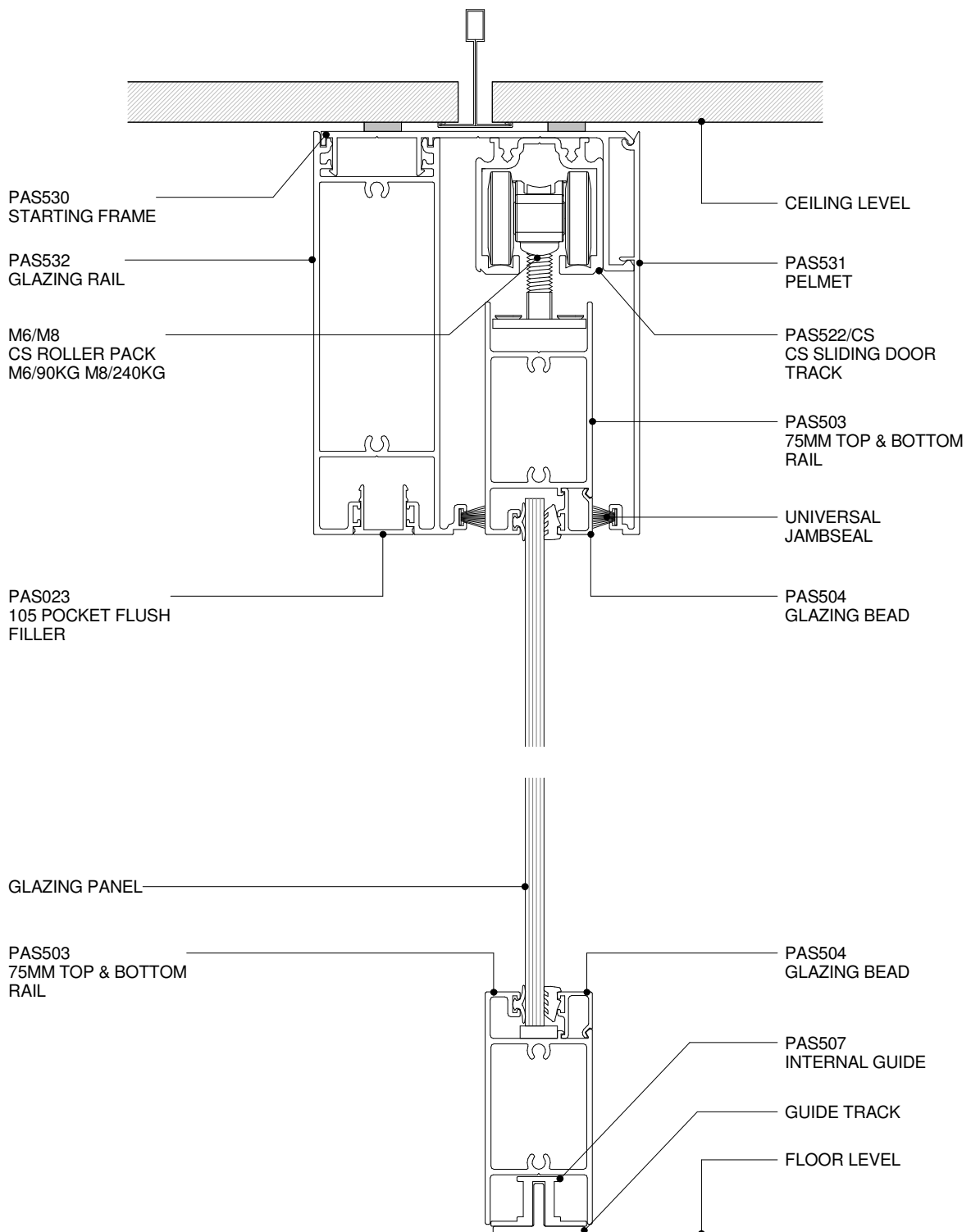

**POTTER ALUMINIUM SYSTEMS**  
**DS SERIES - 130 SLIDER - 75MM DOOR & OPENING**  
**CROSS SECTION**

**5.6.2**

SHEET

1 : 2 @ A4  
SCALE

10/01/2011  
ISSUED DATE

0800 POTTER (0800 768 837) WWW.POTTERS.CO.NZ  
DETAILS SUBJECT TO CHANGE WITHOUT NOTICE

**CSR**

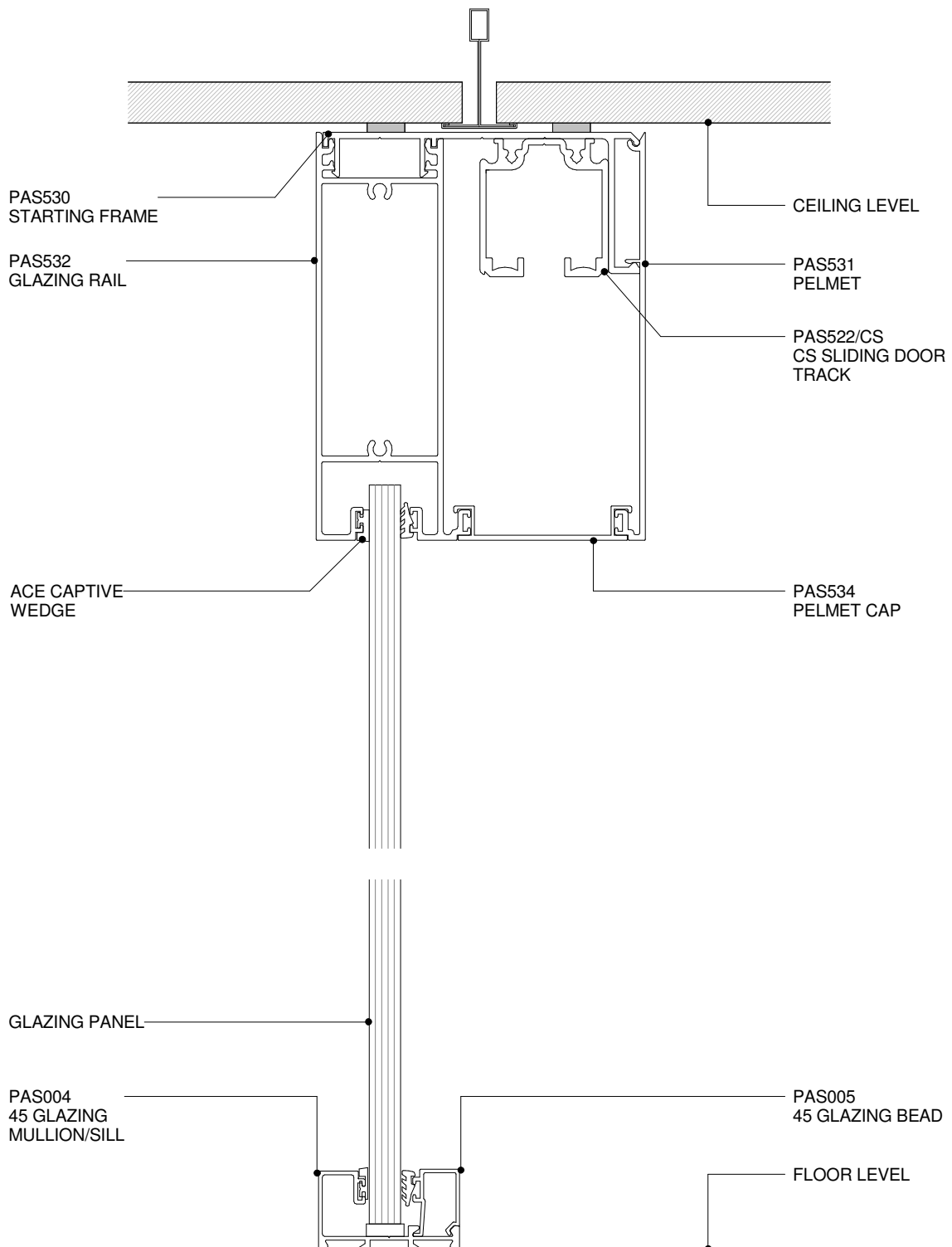

**POTTER ALUMINIUM SYSTEMS**  
**DS SERIES - 130 SLIDER - 100MM DOOR & GLAZING**  
**CROSS SECTION**

**5.6.3**

SHEET

1 : 2 @ A4  
 SCALE

10/01/2011  
 ISSUED DATE

0800 POTTER (0800 768 837) WWW.POTTERS.CO.NZ  
 DETAILS SUBJECT TO CHANGE WITHOUT NOTICE

**CSR**

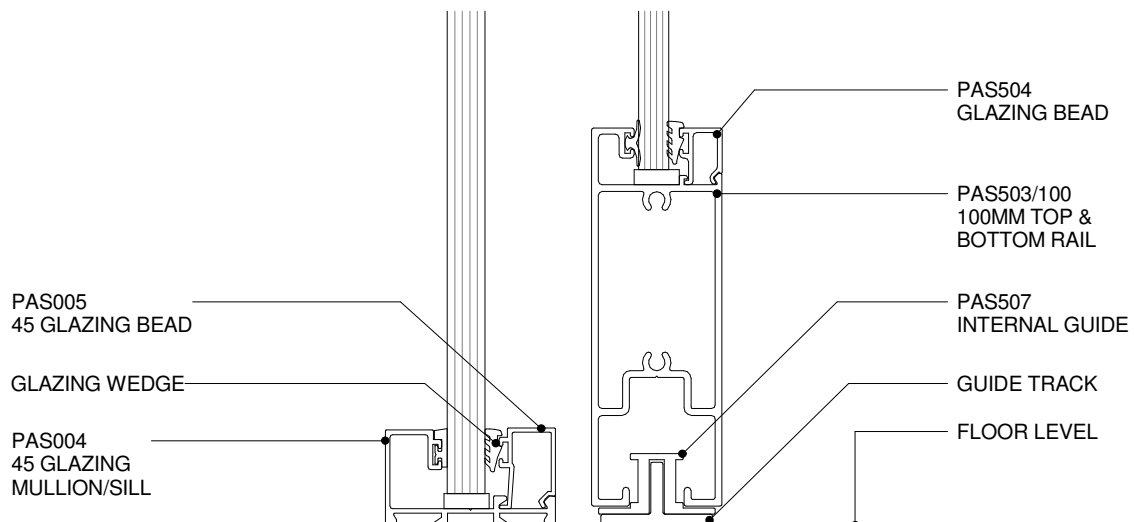
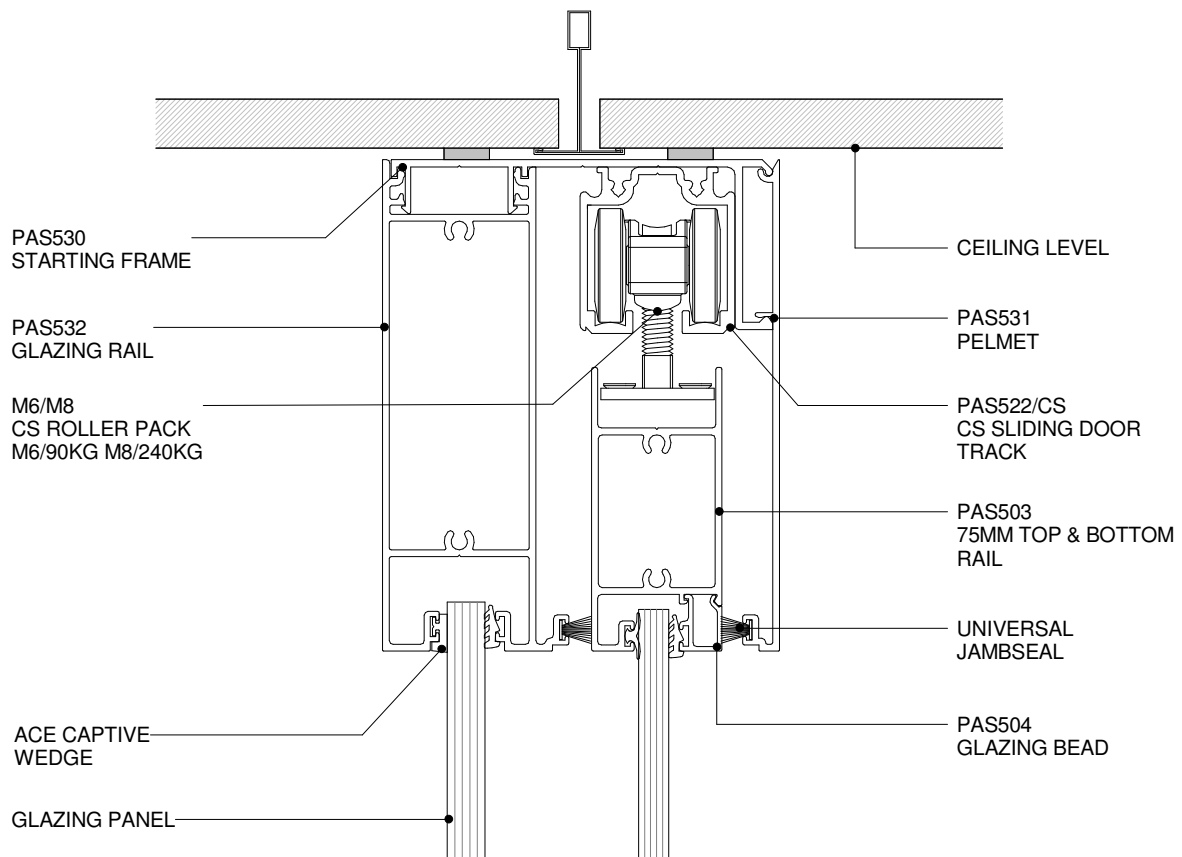

**POTTER ALUMINIUM SYSTEMS**  
**DS SERIES - 130 SLIDER - 100MM DOOR & GLAZING**  
**CROSS SECTION**

**5.6.4**  
 SHEET

1 : 2 @ A4  
 SCALE

10/01/2011  
 ISSUED DATE

0800 POTTER (0800 768 837) WWW.POTTERS.CO.NZ  
 DETAILS SUBJECT TO CHANGE WITHOUT NOTICE



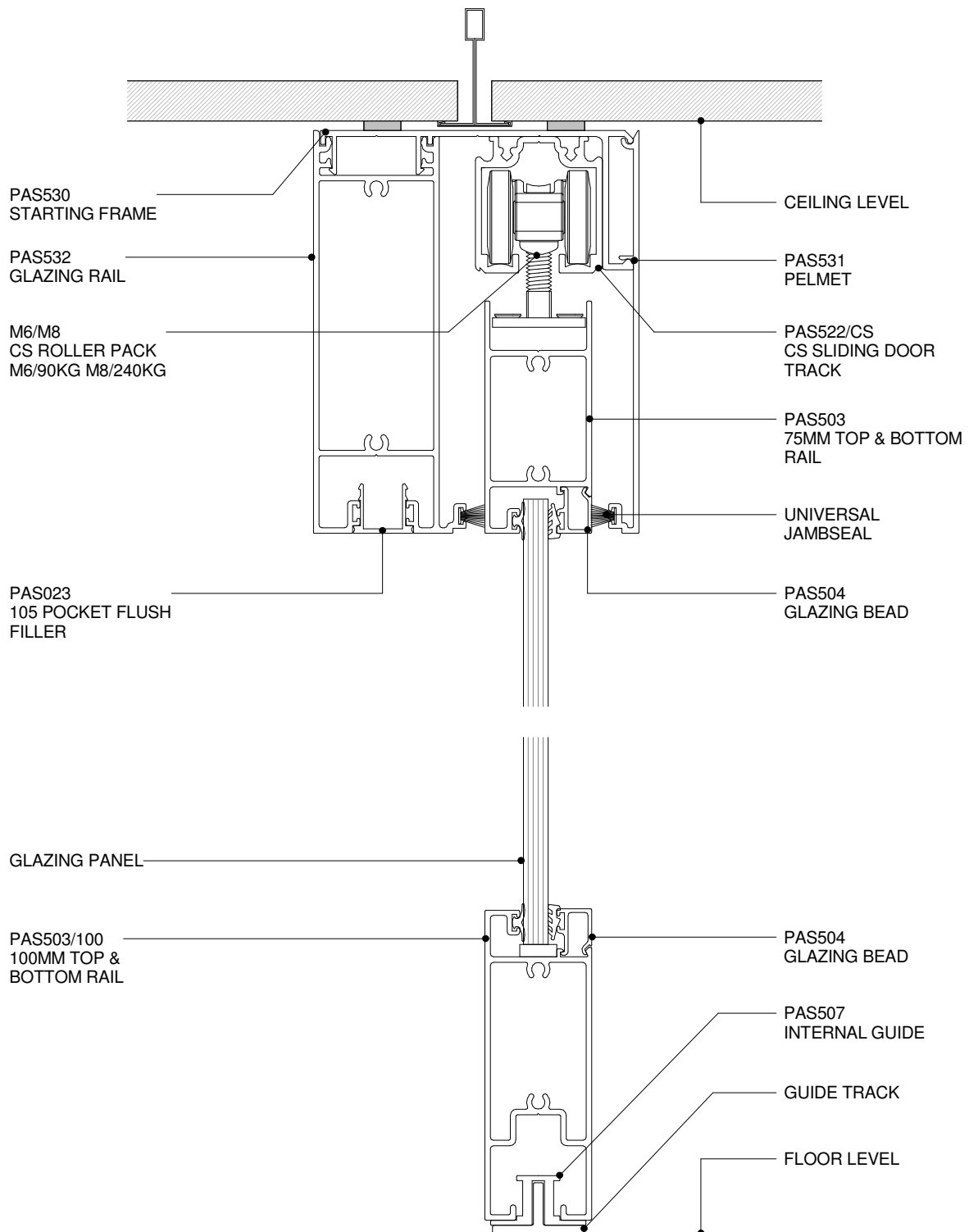

**POTTER ALUMINIUM SYSTEMS**  
**DS SERIES - 130 SLIDER - 100MM DOOR & OPENING**  
**CROSS SECTION**

**5.6.5**  
 SHEET

1 : 2 @ A4  
 SCALE

10/01/2011  
 ISSUED DATE

0800 POTTER (0800 768 837) WWW.POTTERS.CO.NZ  
 DETAILS SUBJECT TO CHANGE WITHOUT NOTICE

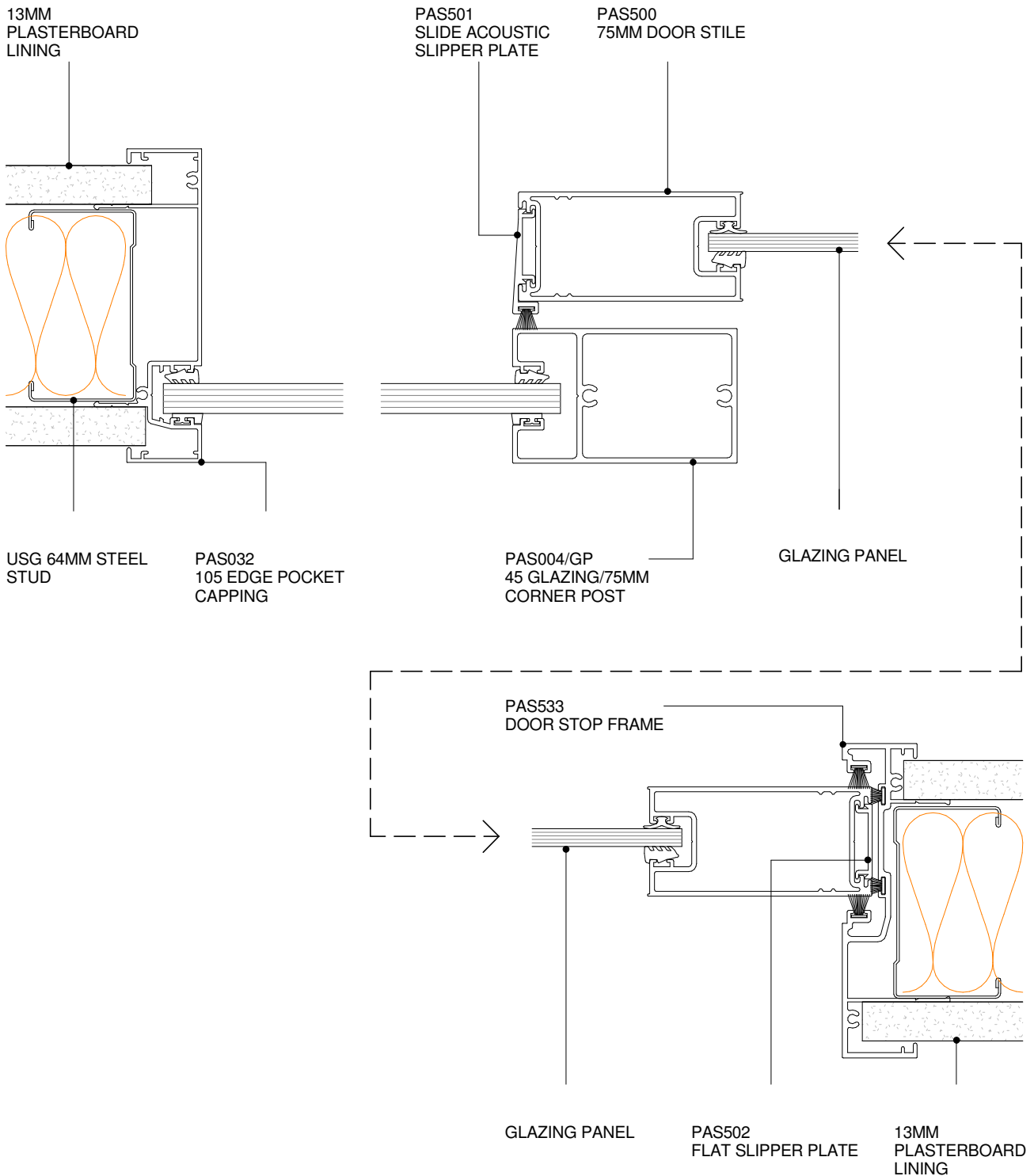

**POTTER ALUMINIUM SYSTEMS**  
**DS SERIES - SLIDER - 75MM DOOR**  
**PLAN VIEW**

**5.6.6**  
SHEET

1 : 2 @ A4  
SCALE

10/01/2011  
ISSUED DATE

0800 POTTER (0800 768 837) WWW.POTTERS.CO.NZ  
 DETAILS SUBJECT TO CHANGE WITHOUT NOTICE



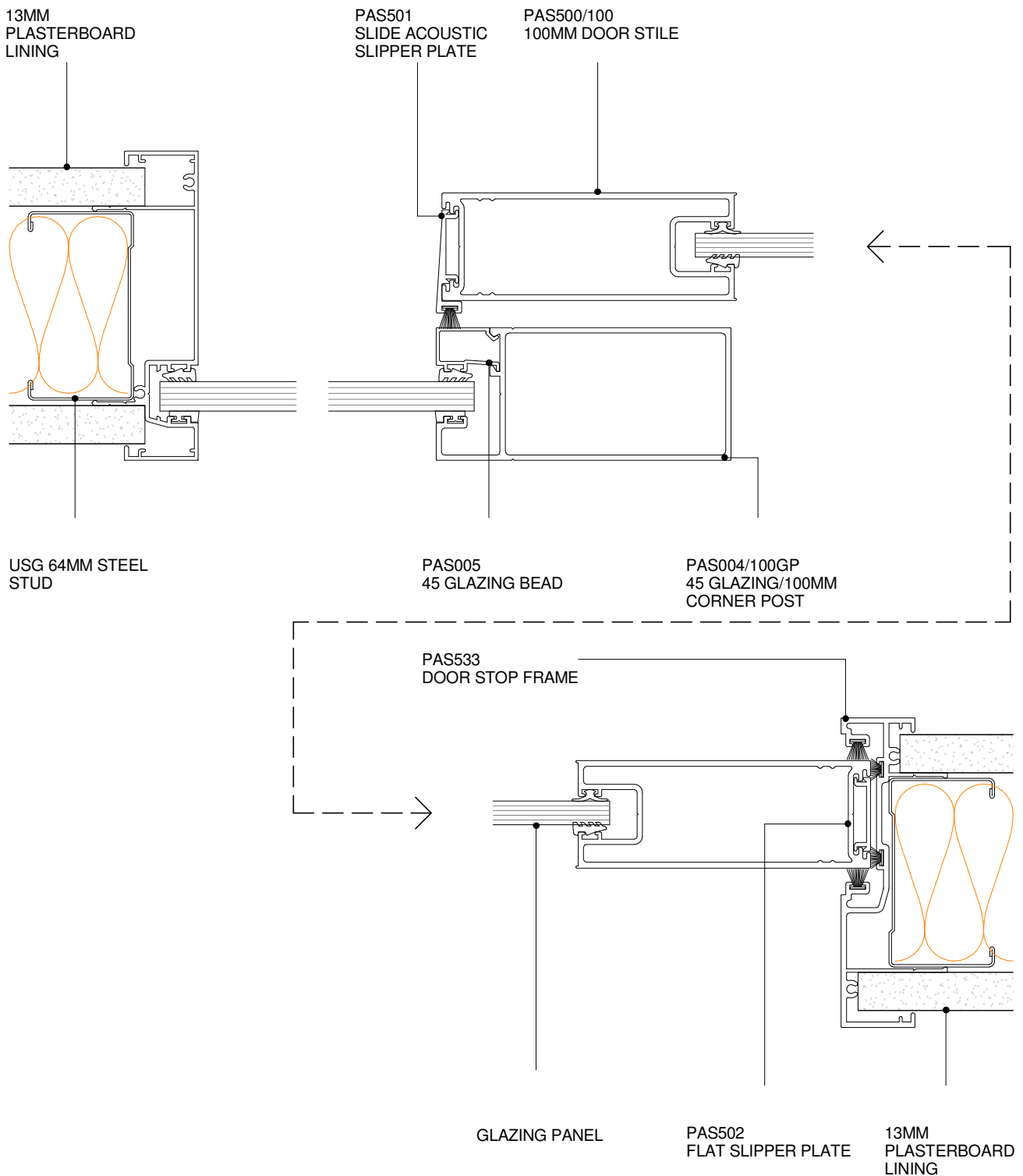

DS SERIES

**POTTER ALUMINIUM SYSTEMS**  
**DS SERIES - SLIDER - 100MM DOOR**  
**PLAN VIEW**

**5.6.7**  
 SHEET

1 : 2 @ A4  
 SCALE

10/01/2011  
 ISSUED DATE

0800 POTTER (0800 768 837) WWW.POTTERS.CO.NZ  
 DETAILS SUBJECT TO CHANGE WITHOUT NOTICE



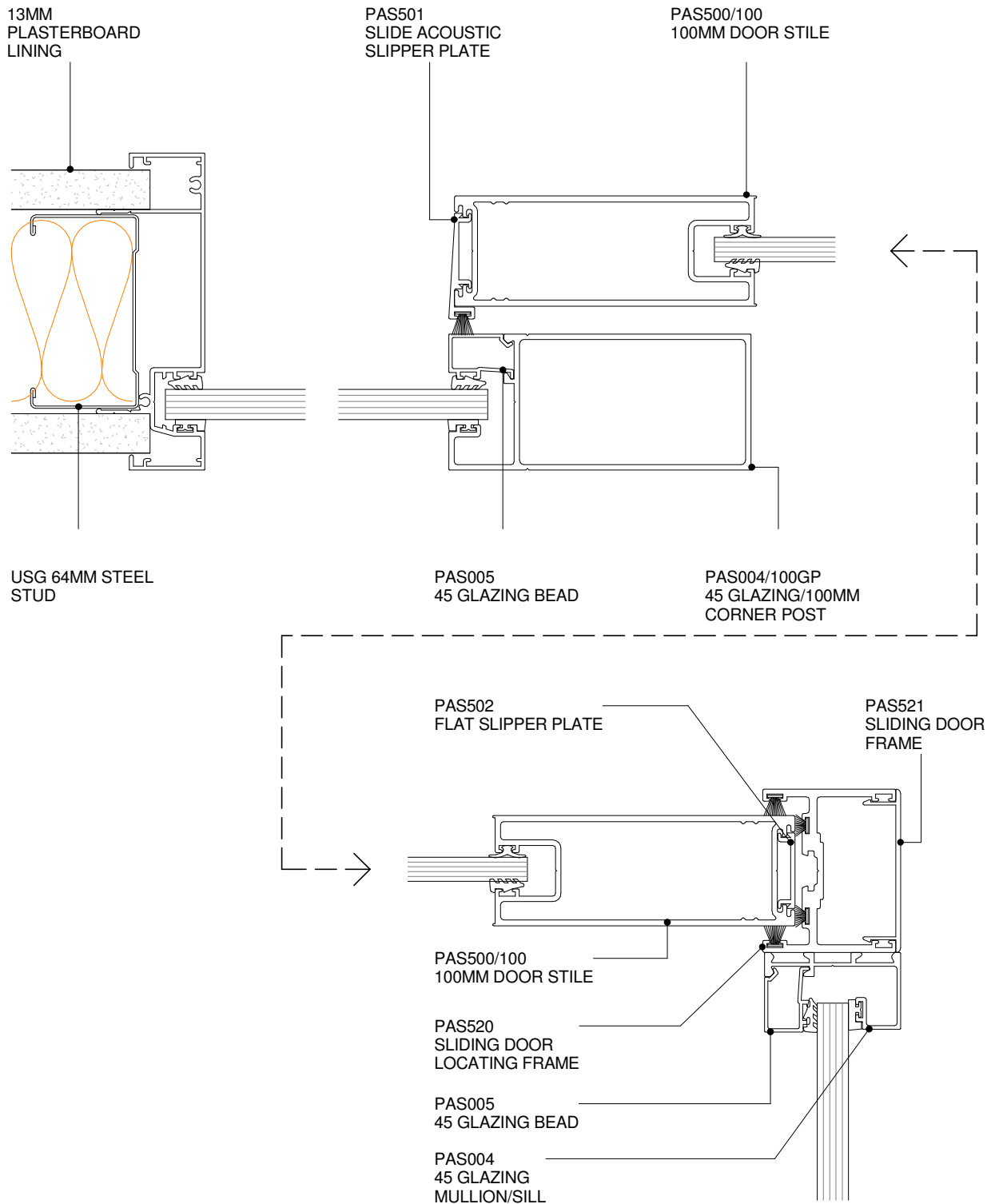

**POTTER ALUMINIUM SYSTEMS**  
**DS SERIES - SLIDER - 100MM DOOR 2**  
**PLAN VIEW**
**5.6.8**

SHEET

 1 : 2 @ A4  
 SCALE

 10/01/2011  
 ISSUED DATE

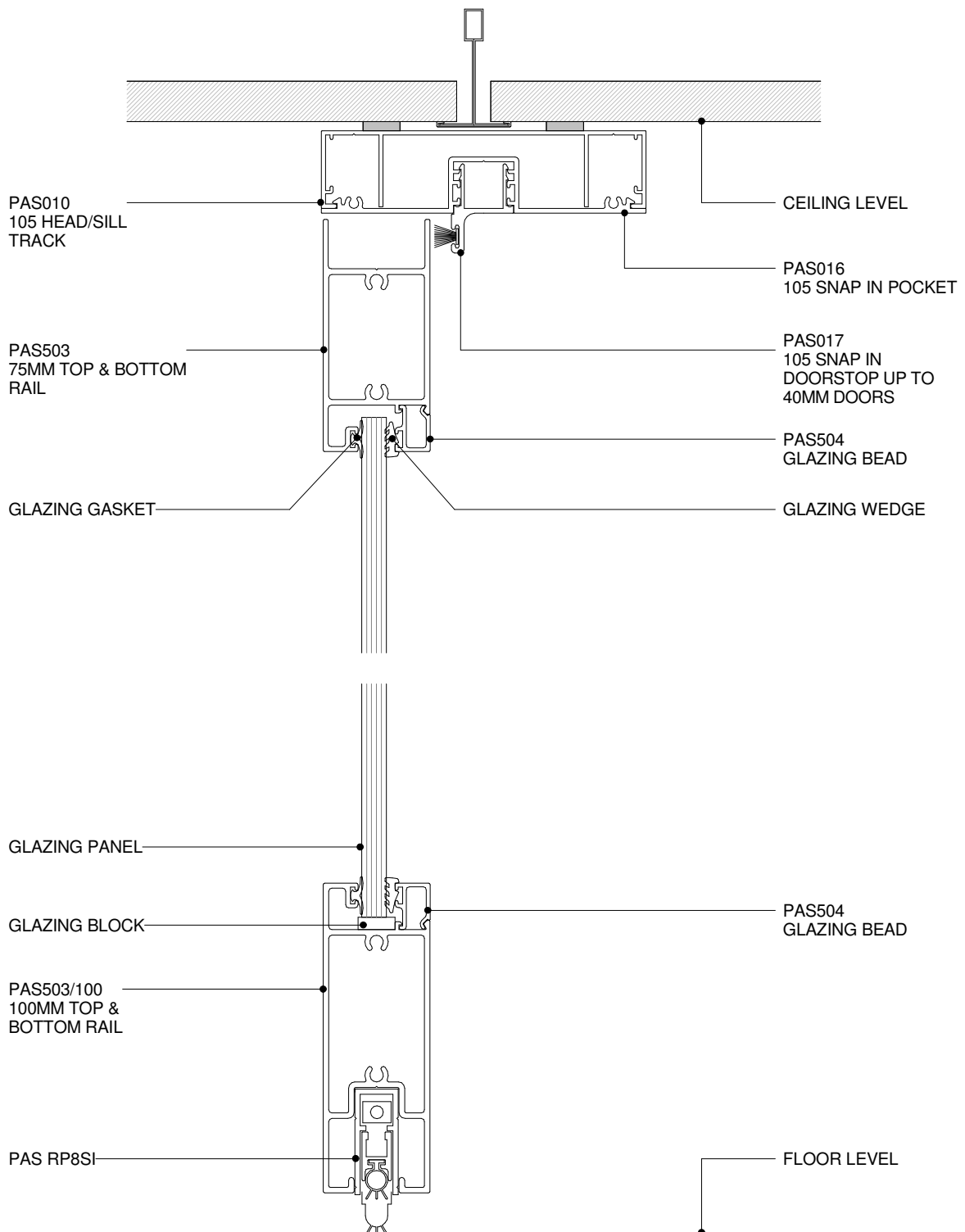
 0800 POTTER (0800 768 837) WWW.POTTERS.CO.NZ  
 DETAILS SUBJECT TO CHANGE WITHOUT NOTICE



**POTTER ALUMINIUM SYSTEMS**  
**DS SERIES - DOOR WITH RP8SI DOOR SEAL**  
**CROSS SECTION**

**5.6.9**  
 SHEET

1 : 2 @ A4  
 SCALE

10/01/2011  
 ISSUED DATE

0800 POTTER (0800 768 837) WWW.POTTERS.CO.NZ  
 DETAILS SUBJECT TO CHANGE WITHOUT NOTICE

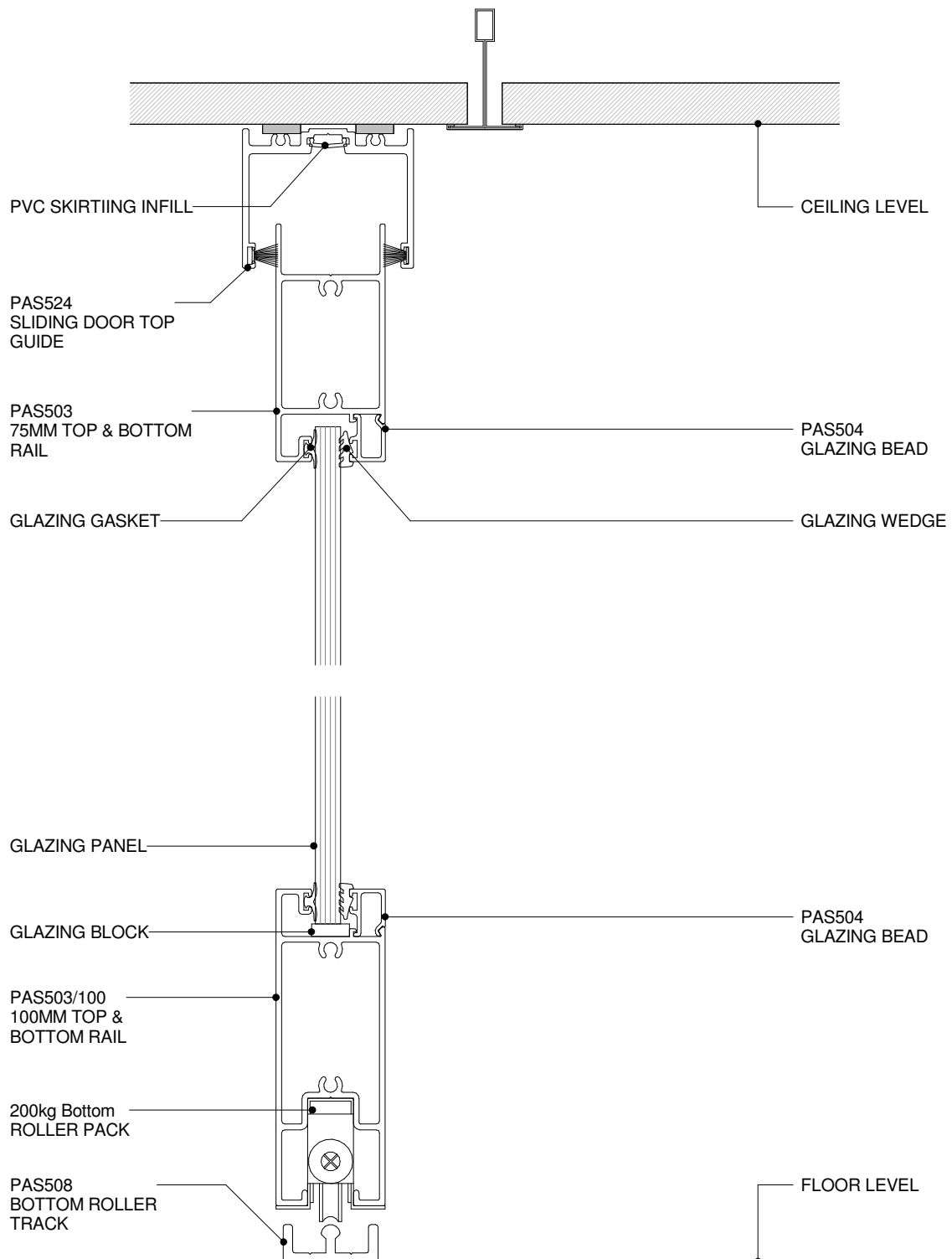
**DS SERIES**
**POTTER ALUMINIUM SYSTEMS**  
**DS SERIES - DOOR WITH TIMBERLINE ROLLER**  
**SECTION**
**CROSS**

**5.6.10**

SHEET

 1 : 2 @ A4  
 SCALE

 10/01/2011  
 ISSUED DATE

 0800 POTTER (0800 768 837) WWW.POTTERS.CO.NZ  
 DETAILS SUBJECT TO CHANGE WITHOUT NOTICE

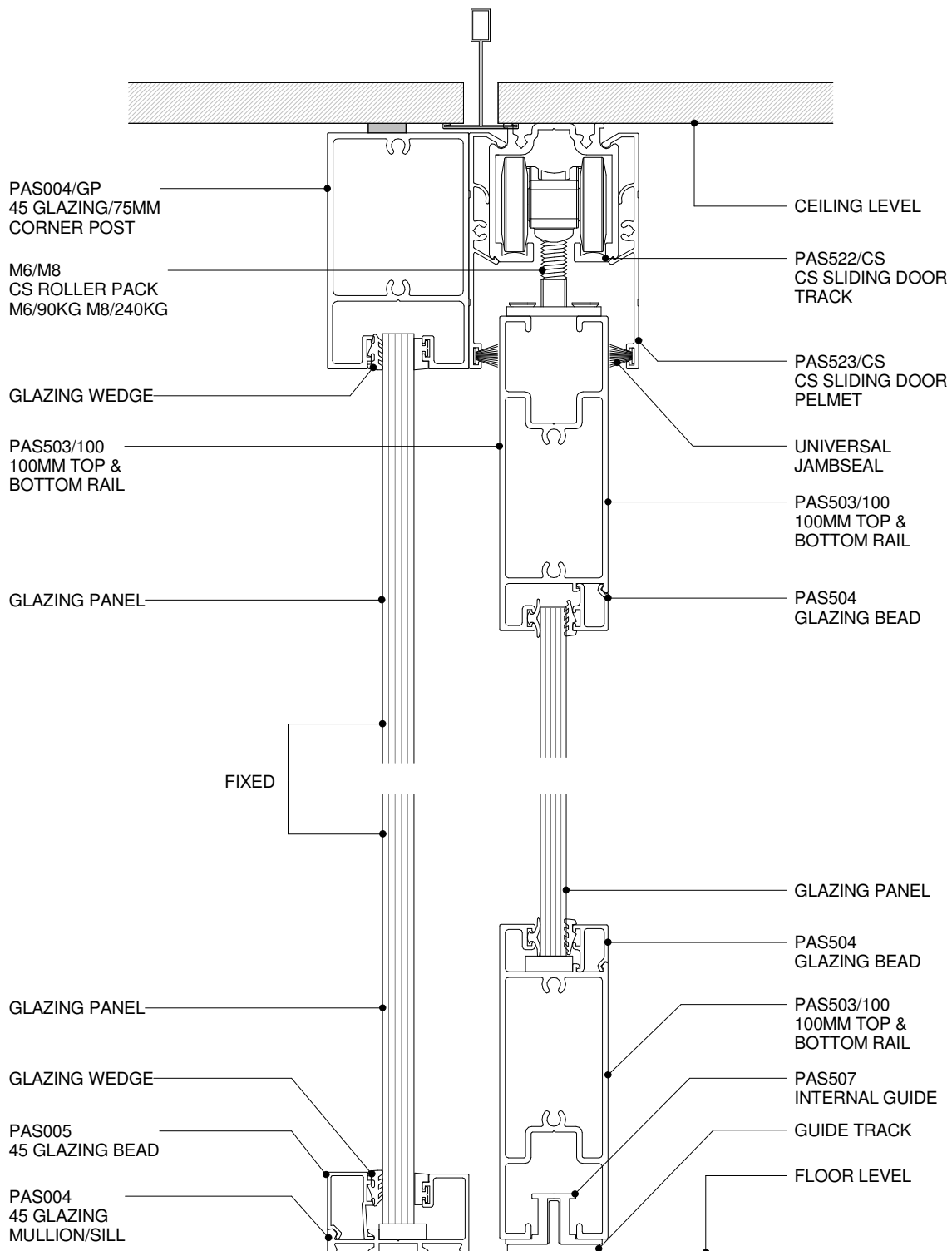

**POTTER ALUMINIUM SYSTEMS**  
**DS SERIES - 75 SLIDER - 100MM DOOR & GLAZING**  
**CROSS SECTION**

**5.6.11**  
 SHEET

1 : 2 @ A4  
 SCALE

10/01/2011  
 ISSUED DATE

0800 POTTER (0800 768 837) WWW.POTTERS.CO.NZ  
 DETAILS SUBJECT TO CHANGE WITHOUT NOTICE

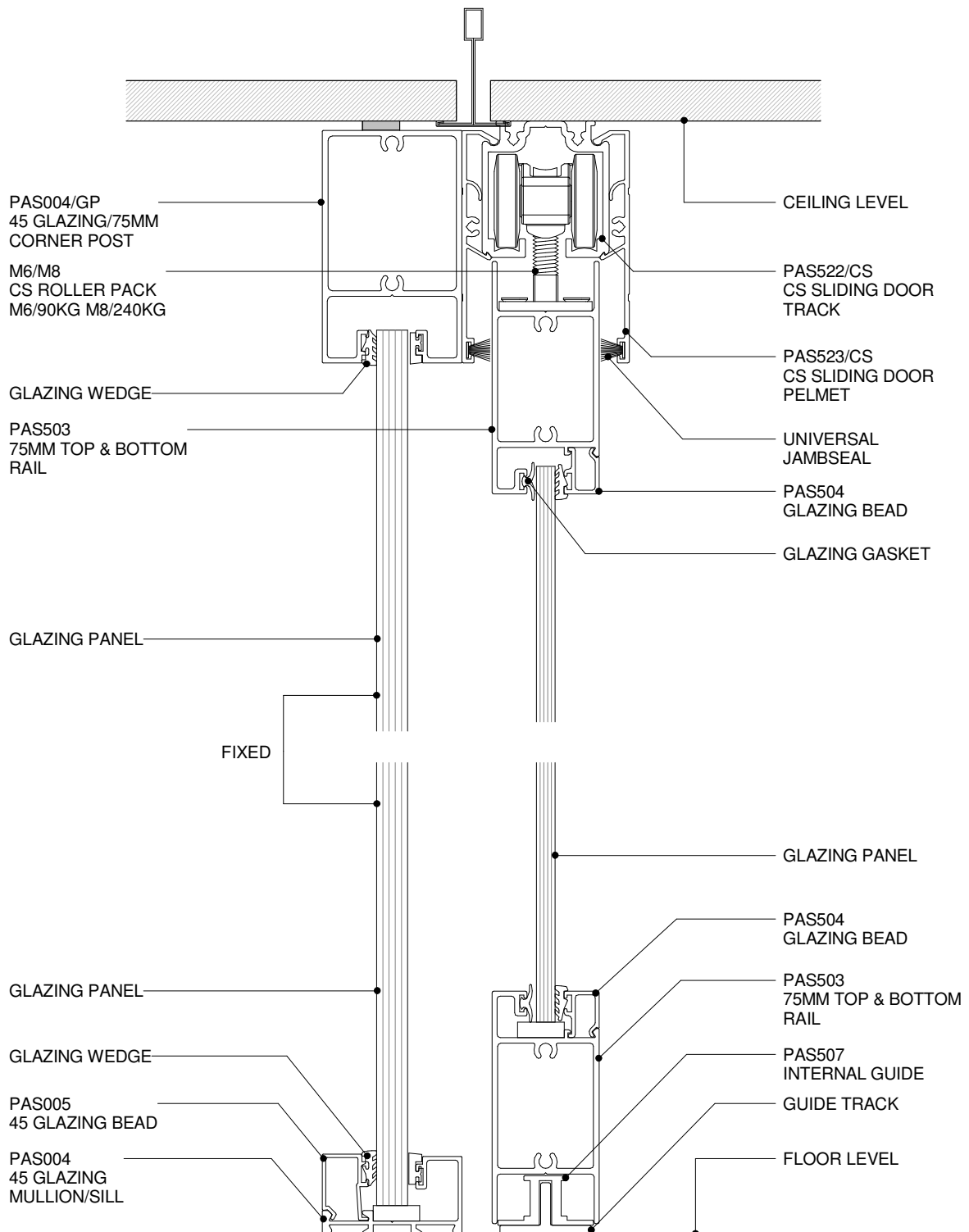
**POTTER ALUMINIUM SYSTEMS  
 DS SERIES - 75 SLIDER - 75MM DOOR & GLAZING  
 CROSS SECTION**
**5.6.12**

SHEET

 1 : 2 @ A4  
 SCALE

 10/01/2011  
 ISSUED DATE

 0800 POTTER (0800 768 837) WWW.POTTERS.CO.NZ  
 DETAILS SUBJECT TO CHANGE WITHOUT NOTICE

**CSR**



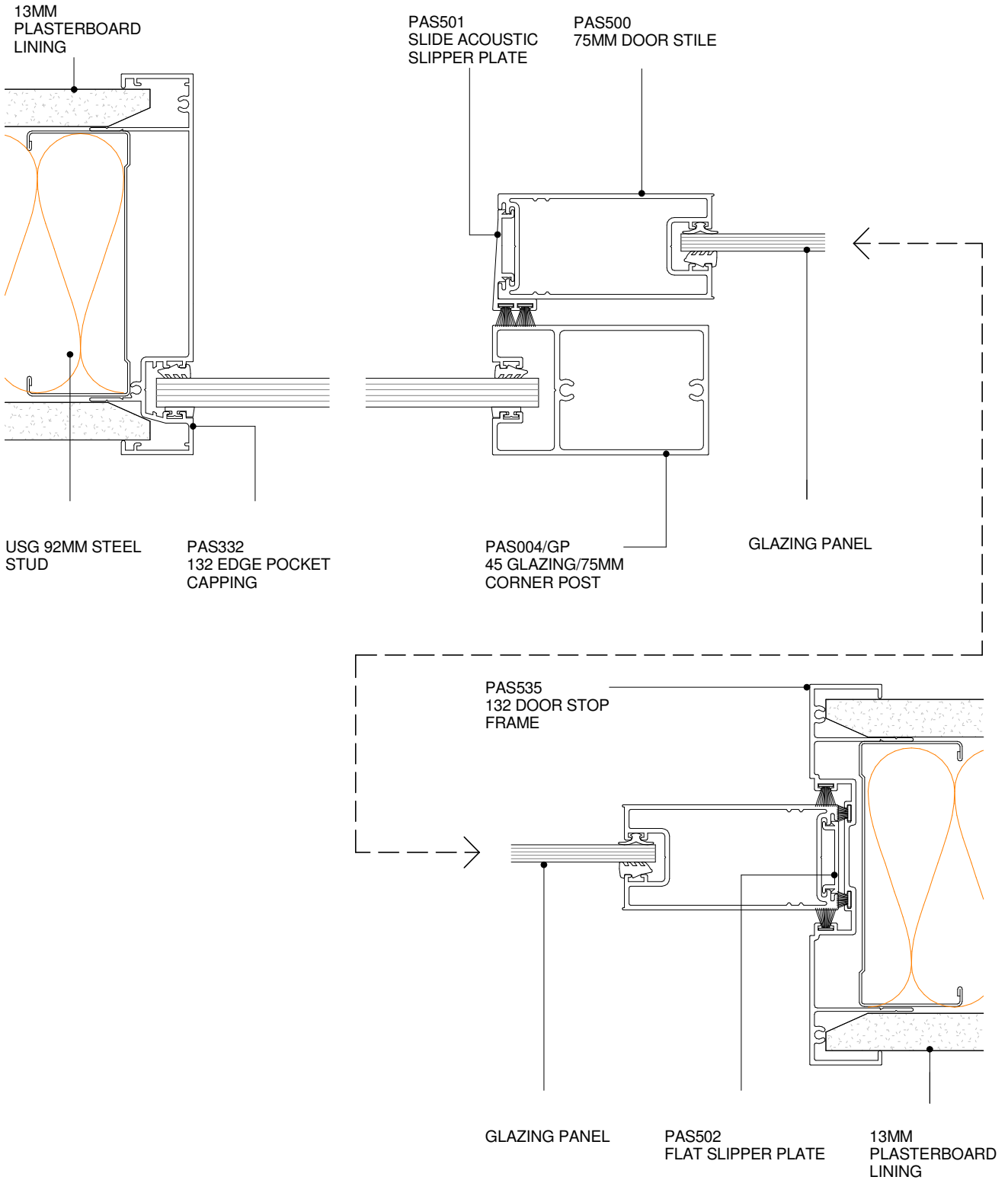

**POTTER ALUMINIUM SYSTEMS**  
**DS SERIES - SLIDER - 75MM DOOR 132 WALL SYSTEM**  
**PLAN VIEW**

**X.4.42**  
 SHEET

1 : 2 @ A4  
 SCALE

10/02/14  
 ISSUED DATE

0800 POTTER (0800 768 837) WWW.POTTERS.CO.NZ  
 SUBJECT TO CHANGE WITHOUT NOTICE



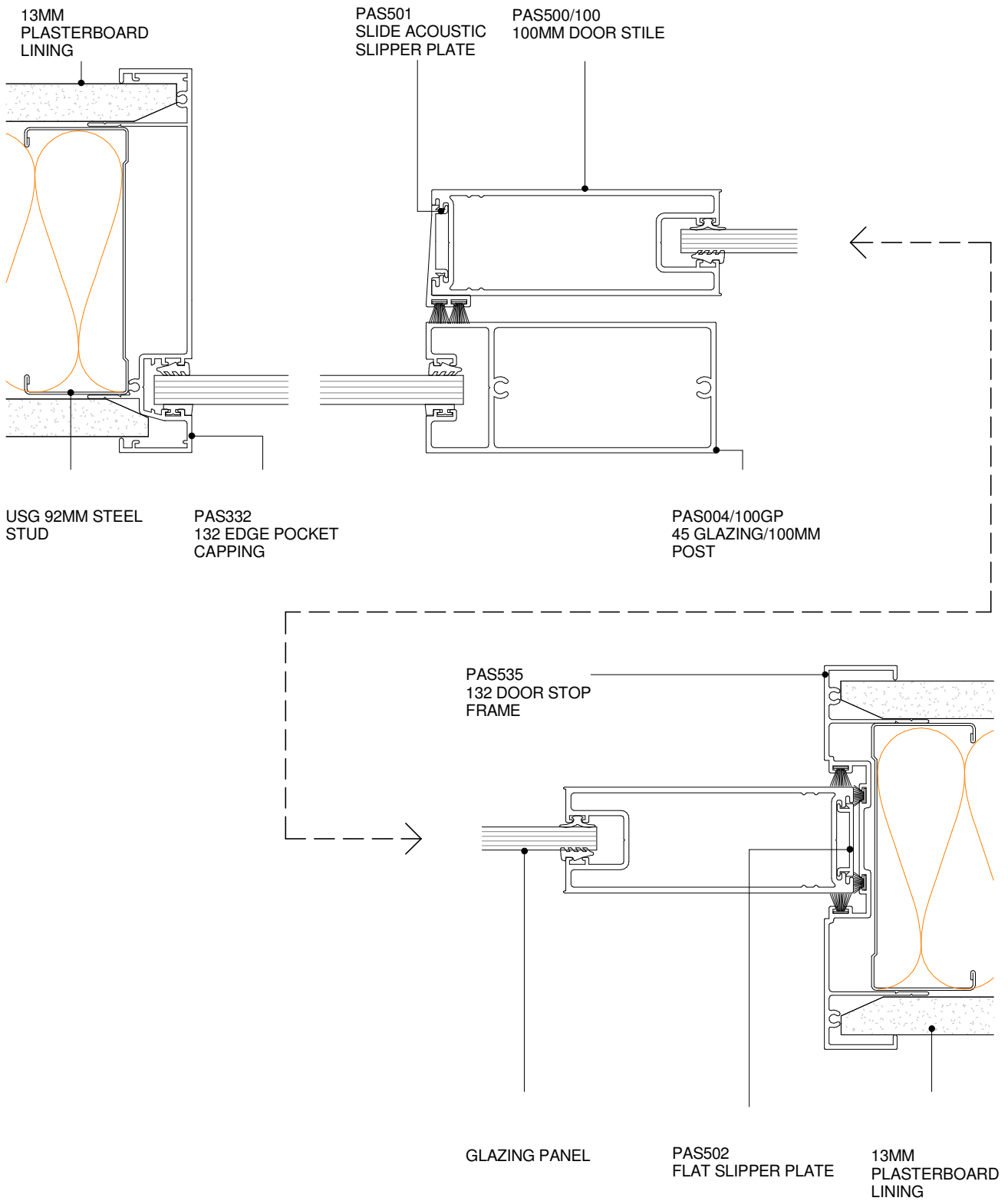

**POTTER ALUMINIUM SYSTEMS**  
**DS SERIES - SLIDER - 100MM DOOR 132 WALL SYSTEM**  
**PLAN VIEW**

**X.4.43**

SHEET

1 : 2 @ A4  
 SCALE

10/02/14  
 ISSUED DATE

0800 POTTER (0800 768 837) WWW.POTTERS.CO.NZ  
 SUBJECT TO CHANGE WITHOUT NOTICE



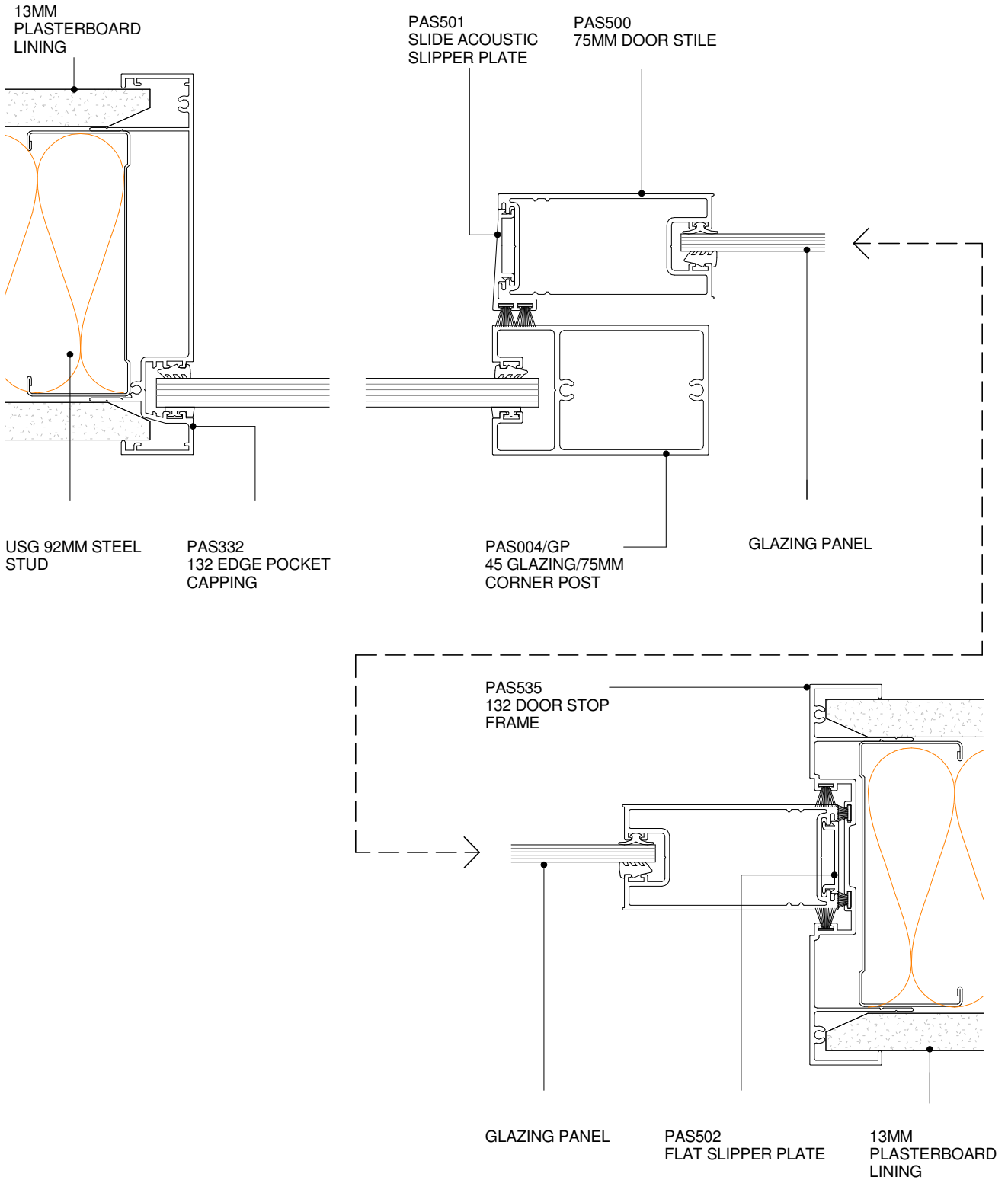

**POTTER ALUMINIUM SYSTEMS**  
**DS SERIES - SLIDER - 75MM DOOR 132 WALL SYSTEM**  
**PLAN VIEW**

**X.4.42**  
 SHEET

1 : 2 @ A4  
 SCALE

10/02/14  
 ISSUED DATE

0800 POTTER (0800 768 837) WWW.POTTERS.CO.NZ  
 SUBJECT TO CHANGE WITHOUT NOTICE



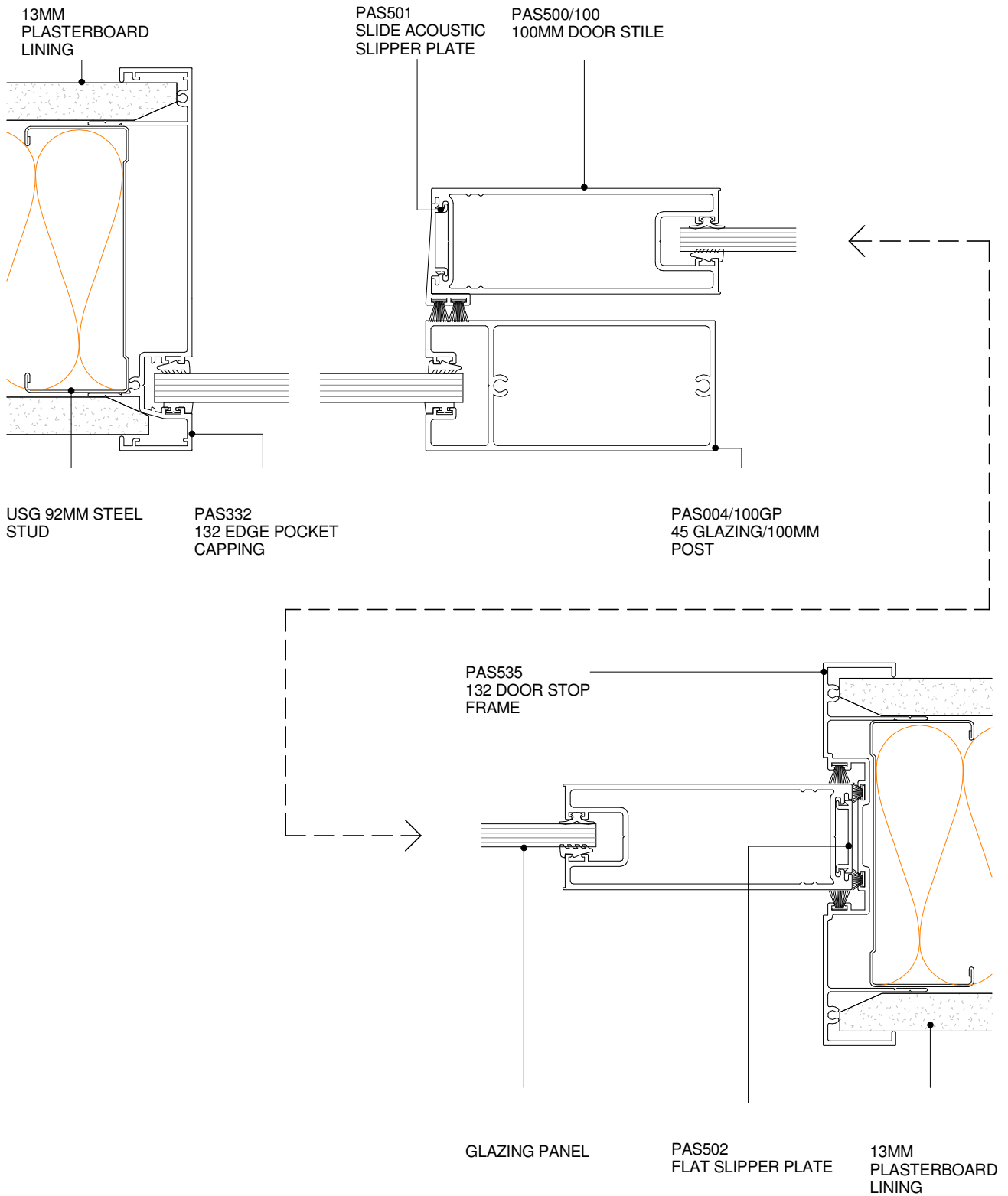

**POTTER ALUMINIUM SYSTEMS**  
**DS SERIES - SLIDER - 100MM DOOR 132 WALL SYSTEM**  
**PLAN VIEW**

**X.4.43**

SHEET

1 : 2 @ A4  
SCALE

10/02/14  
ISSUED DATE

0800 POTTER (0800 768 837) WWW.POTTERS.CO.NZ  
SUBJECT TO CHANGE WITHOUT NOTICE

**CSR**