

40MM WINDOW SERIES, A120FS STRIP WINDOW SQUARE BEAD CROSS SECTION

Cad Ref. AC4004-0

Scale 1:2

Date 01.01.09

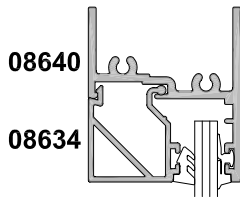
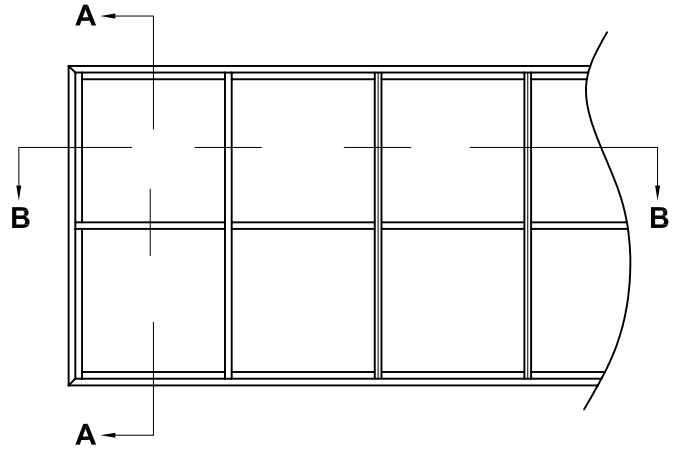

SECTION A-A

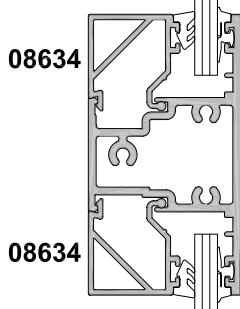

08625 Transom
Refer to tables for span requirements

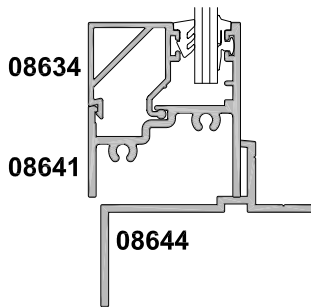

08644

SECTION B-B

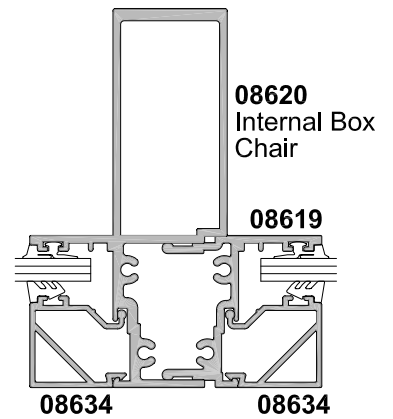
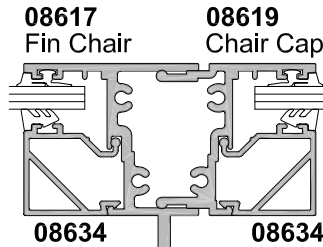
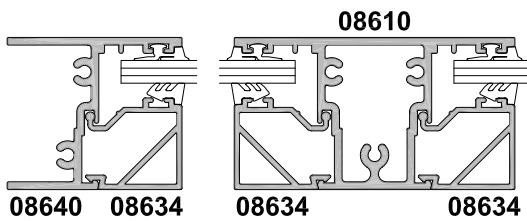

Refer to tables for span requirements