

TRU-CLOSE HEAVY DUTY HINGES ON PED GATE
1:4

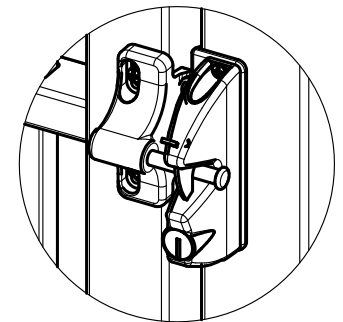

LOKKLATCH ON PED GATE
1:4

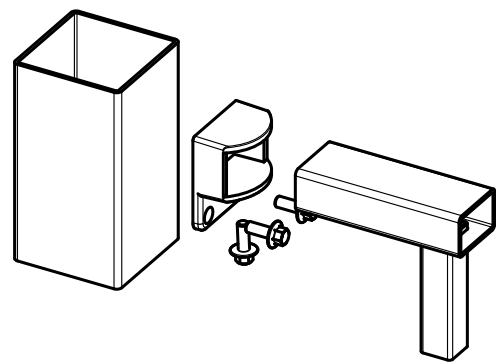

FIXED PANEL TO POST DETAIL
1:4

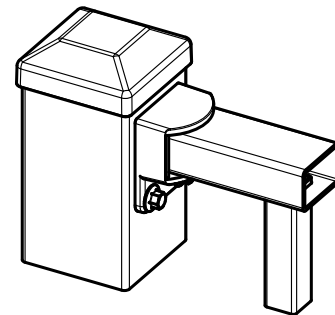

FIXED PANEL TO POST DETAIL
1:4

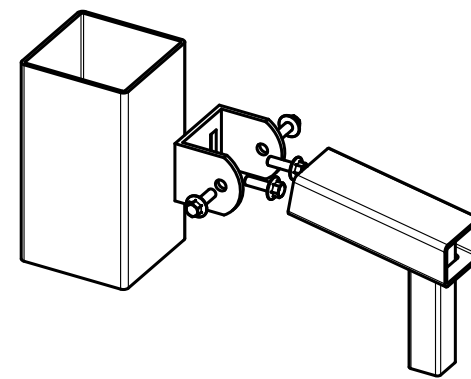

RAKING PANEL TO POST DETAIL
1:4

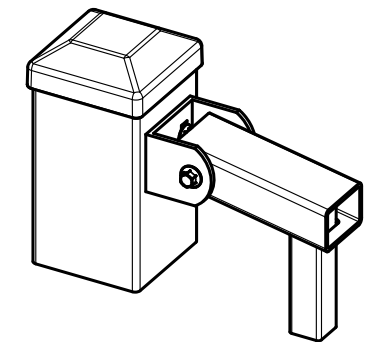

RAKING PANEL TO POST DETAIL
1:4

PANEL CODE	DESCRIPTION	BRACKET CODE	HEIGHT	WIDTH	PANEL RAKE	HORIZONTALS	VERTICALS	TUBE SPACINGS
UFASS18	ASSURE FENCE PANEL	HBKT38	1750	2400	N/A	38X25X2 RHS	18X18X1.1 SHS	80 (98 CENTRES)
UFASSR18	ASSURE RAKING FENCE PANEL	HBKTR38	1750	2400	30 DEGREES	38X25X2 RHS	18X18X1.1 SHS	80 (98 CENTRES)
SGAS/1812	ASSURE PEDESTRIAN GATE	N/A	1750	1170	N/A	38X25X2 RHS	18X18X1.1 SHS	80 (98 CENTRES)



SIZE:	A3	SCALE:	1:25
DRAWING NO:	ASS18 - SS	REVISION:	01
DATE ISSUED:	2023-04-20	SHEET:	1 OF 2

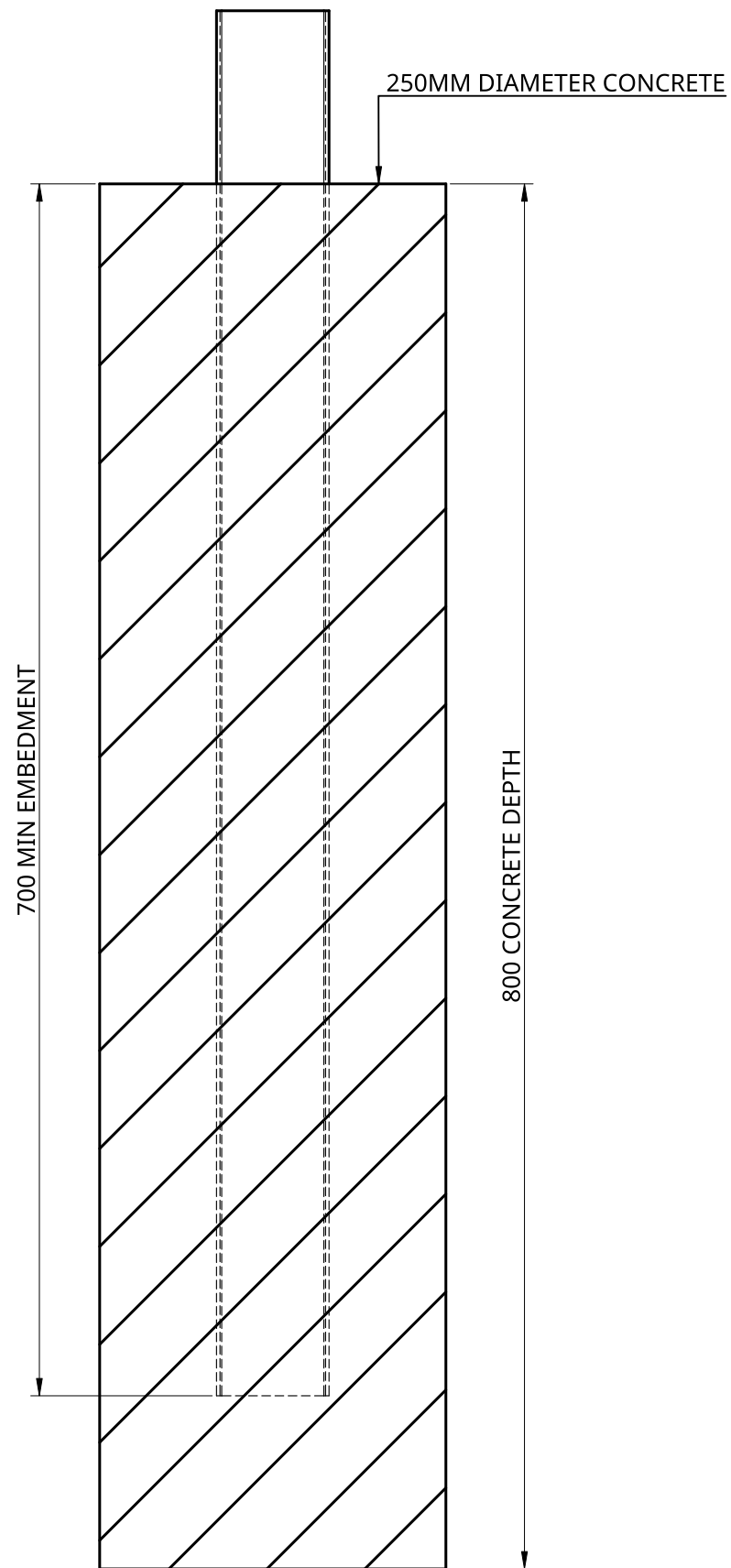

IN GROUND POST CONNECTION

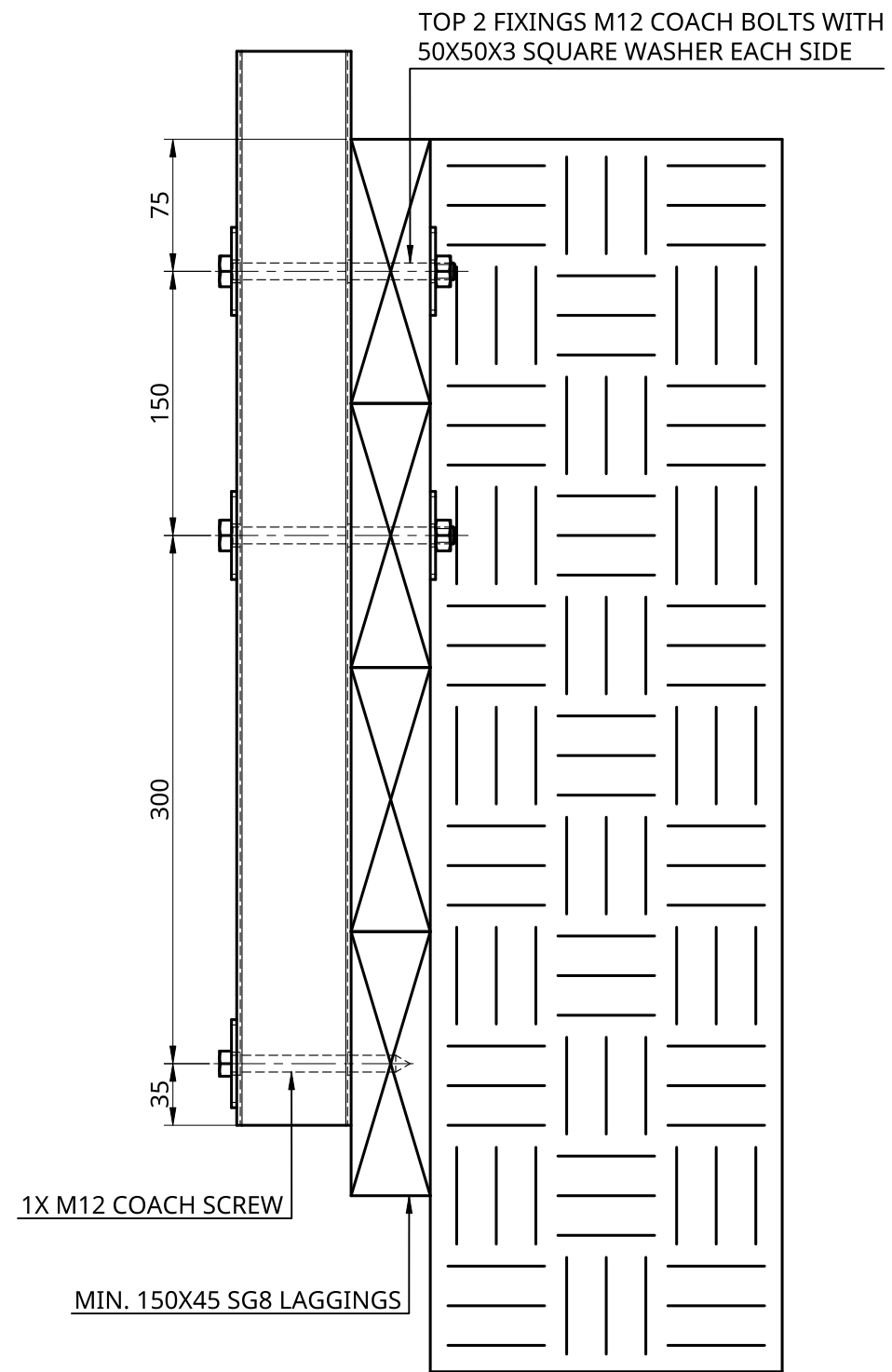

SIDE FIX TO TIMBER RETAINING WALL CONNECTION

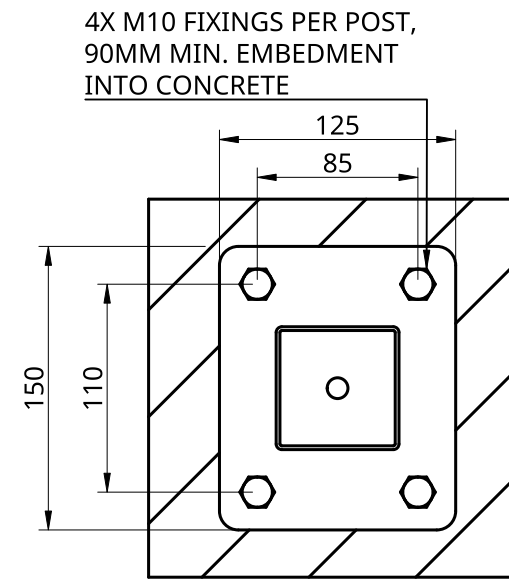

BASEPLATED POST CONNECTION

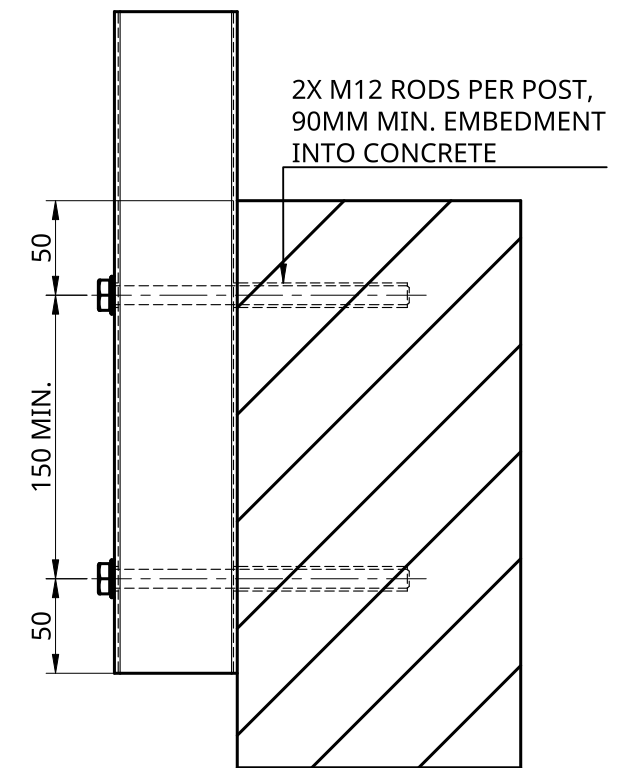

SIDE FIX TO CONCRETE CONNECTION



SIZE:	A3	SCALE:	1:4
DRAWING NO:	ASS18 - SS	REVISION:	01
DATE ISSUED:	2023-04-20	SHEET:	2 OF 2