

100mm CONCRETE + 220mm PODS

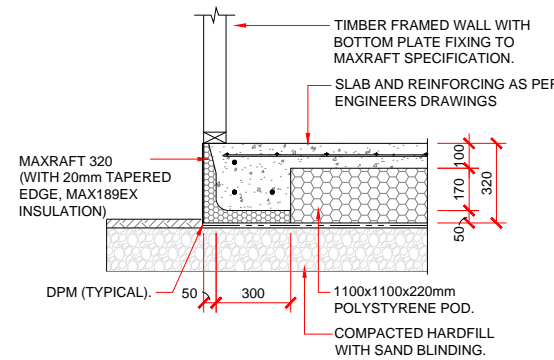

EXTERNAL FOOTING DETAIL
20mm TAPERED - 90mm/140mm FRAMING

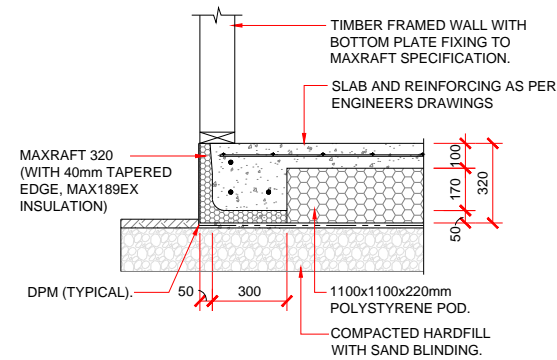

EXTERNAL FOOTING DETAIL
40mm TAPERED - 140mm FRAMING

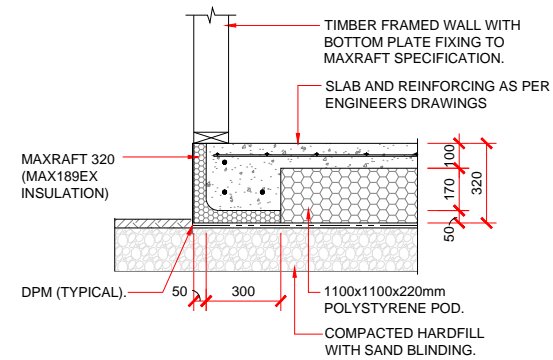

EXTERNAL FOOTING DETAIL
50mm STRAIGHT - 140mm FRAMING

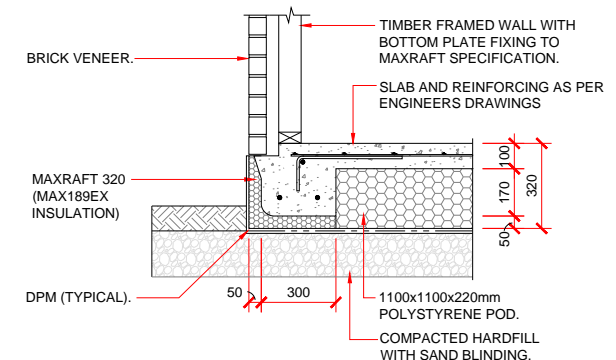

BRICK / STONE VENEER
REBATE DETAIL

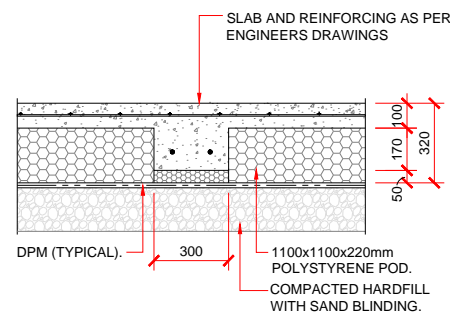

INTERNAL FOOTING DETAIL

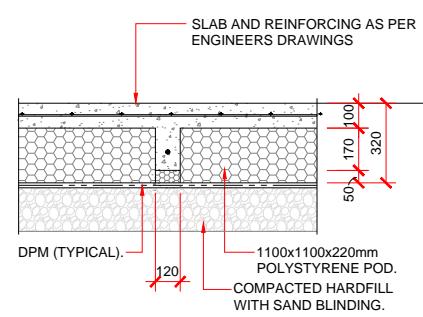

INTERNAL RIB DETAIL

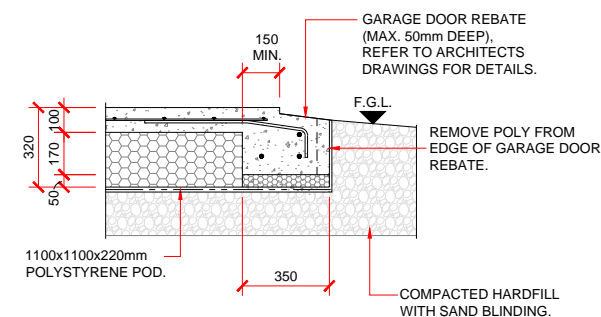

GARAGE DOOR REBATE DETAIL

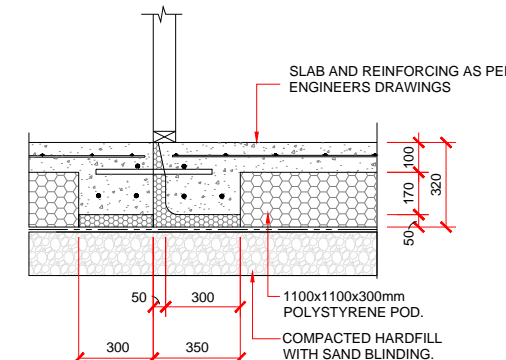

THERMAL BREAK

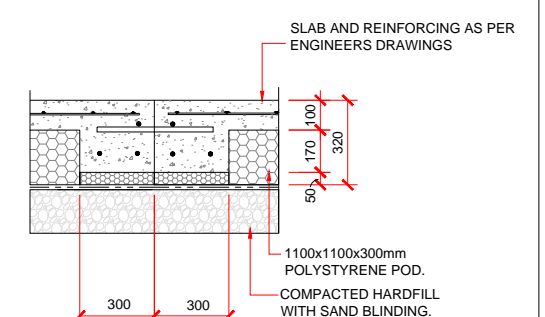

FREE JOINT / CONTROL JOINT DETAIL

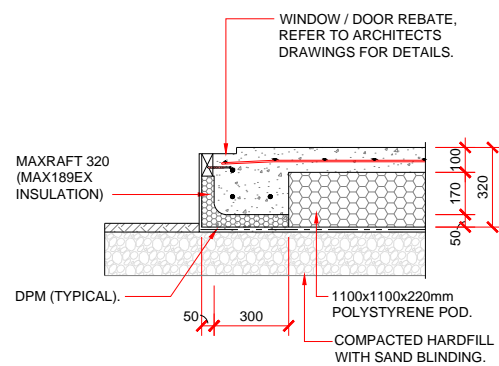

JOINERY REBATE DETAIL

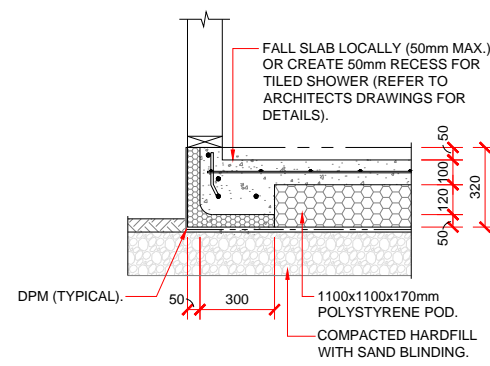

SHOWER RECESS DETAIL - 140mm FRAMING.

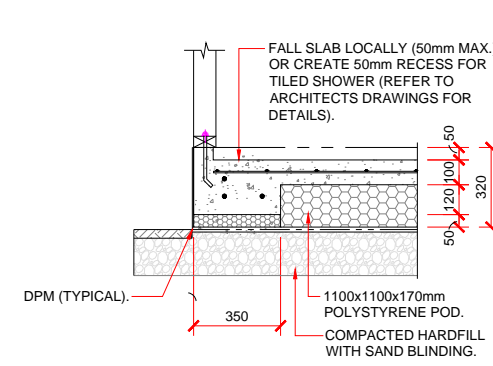

SHOWER RECESS DETAIL - 90mm FRAMING.

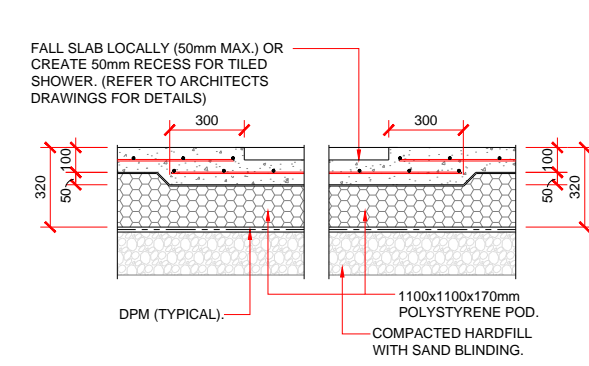

SHOWER RECESS DETAIL.

MAXRAFT 320 DETAILS

DWG NO.

DATE : 2023