

© COPYRIGHT 2010

This drawing and or specification is the property of Euroglass Systems Ltd - and must be returned to them on request. Unauthorised use may result in Legal Action. Its contents must not be made public, nor copied, nor used directly or indirectly in any way.

Tolerance (Unless otherwise stated)

Dec place 0.00 ±0.1mm
 0.0 ±0.2mm
 0 ±0.5mm
 Angular: ±0.5°

Special Instructions:

Remove all burrs & sharp edges.

euroglass

65 Carr Road
 Mt Roskill
 Auckland
 New Zealand
 +694 624-1180

DRAWN IN
 THIRD ANGLE
 PROJECTION

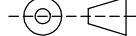

Material: See component drawings

Finish: See component drawings

| REV | MODIFICATIONS | DATE |
|-----|---------------|------------|
| A | First Drawn | 10/06/2011 |
| - | - | - |
| - | - | - |
| - | - | - |
| - | - | - |
| - | - | - |

Drawn:
 P. Wood-Statesbury

Date:
 10/06/2011

Scale (A4): 1:20

Part Name:
 SS30 Inline Shower

Drawing No.
 1021-1

Sheet:
 1 of 10

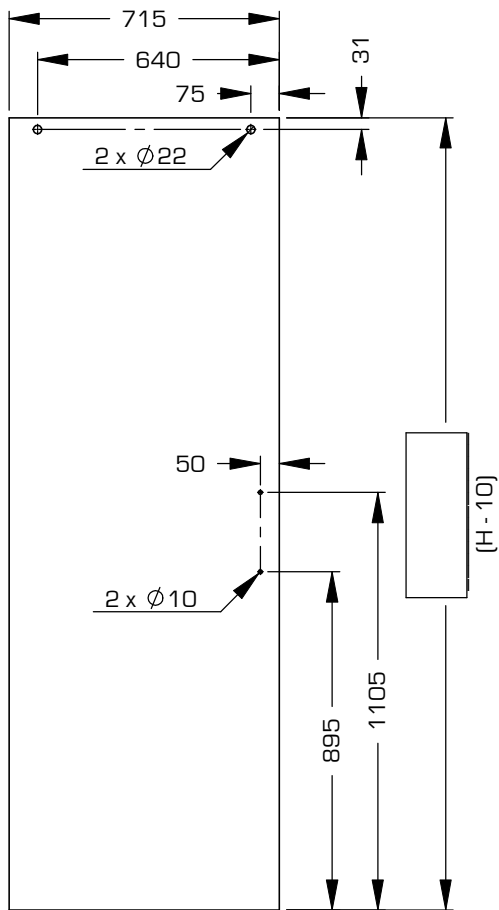

Door
10mm Glass

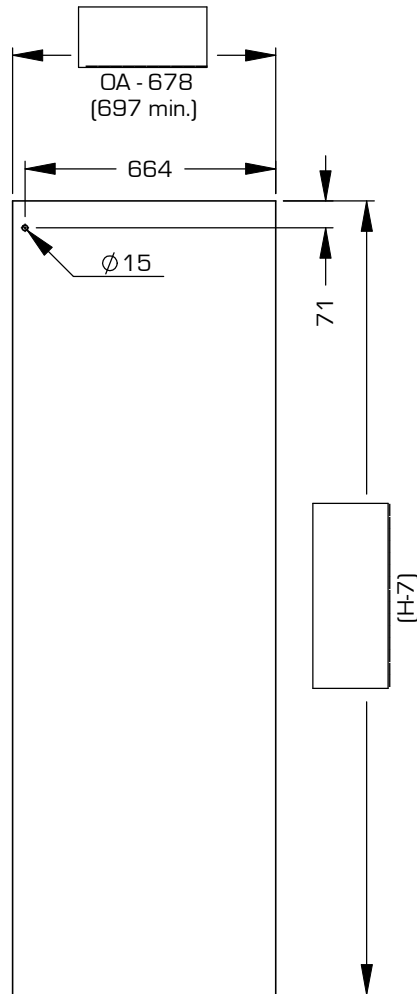

Fixed Panel
10mm Glass

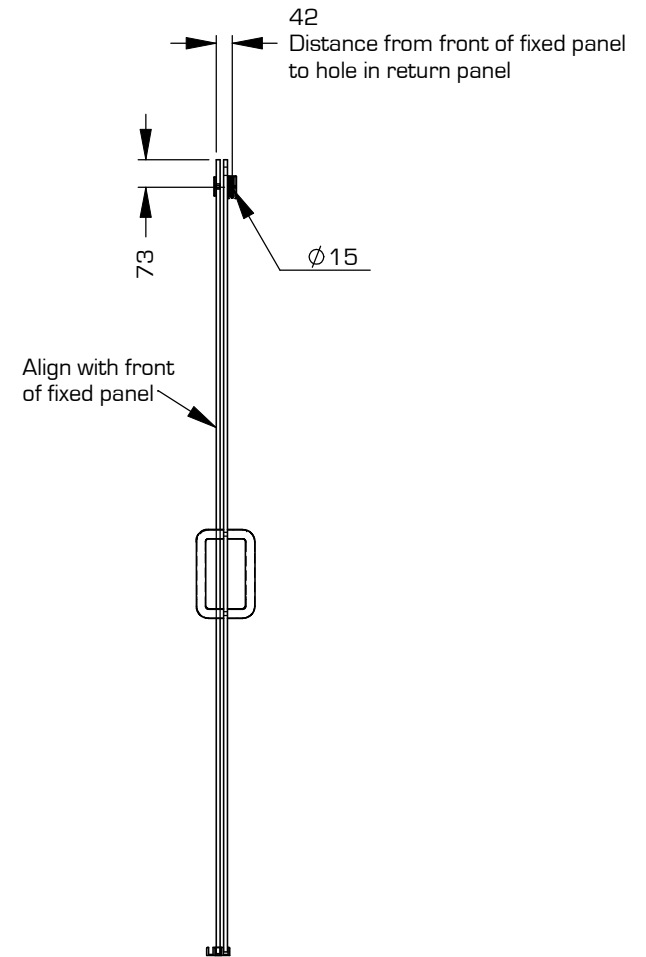

Return panel mounting detail
(for rails mounted to glass)

© COPYRIGHT 2010

This drawing and or specification is the property of Euroglass Systems Ltd - and must be returned to them on request. Unauthorised use may result in Legal Action. Its contents must not be made public, nor copied, nor used directly or indirectly in any way.

Tolerance (Unless otherwise stated)

Dec place 0.00 ±0.1mm
0.0 ±0.2mm
0 ±0.5mm
Angular ±0.5°

Special Instructions:

Remove all burrs & sharp edges.



65 Carr Road
Mt Roskill
Auckland
New Zealand
+694 624-1180

DRAWN IN
THIRD ANGLE
PROJECTION

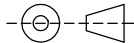

Material: See component drawings

Finish: See component drawings

| REV | MODIFICATIONS | DATE |
|-----|---------------|------------|
| A | First Drawn | 10/06/2011 |
| - | - | - |
| - | - | - |
| - | - | - |
| - | - | - |
| - | - | - |

Drawn:
P. Wood-Statesbury

Date:
10/06/2011

Scale (A4): 1:20

Part Name:
SS30 Inline Shower

Drawing No.
1021-1

Sheet:
2 of 10

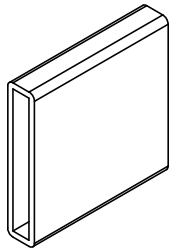

SS30 Rail

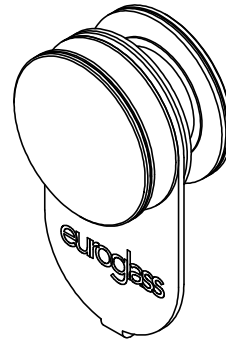

SS30 Roller

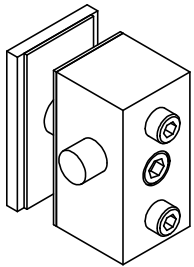

SS30 Stop/Mount Assembly

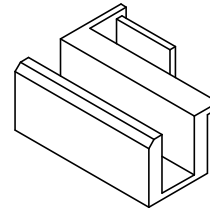

SS30 Floor Guide

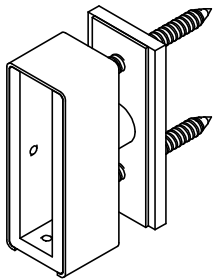

SS30 Wall Mount Assembly

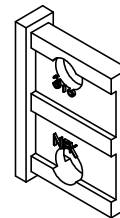

SS30 Rail End Plug

© COPYRIGHT 2010

This drawing and or specification is the property of Euroglass Systems Ltd - and must be returned to them on request. Unauthorised use may result in Legal Action. Its contents must not be made public, nor copied, nor used directly or indirectly in any way.

Tolerance (Unless otherwise stated)

Dec place 0.00 ±0.1mm
 0.0 ±0.2mm
 0 ±0.5mm
 Angular: ±0.5°

Special Instructions:

Remove all burrs & sharp edges.



65 Carr Road
 Mt Roskill
 Auckland
 New Zealand
 +694 624-1180

DRAWN IN
 THIRD ANGLE
 PROJECTION

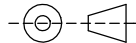

Material: See component drawings

Finish: See component drawings

| REV | MODIFICATIONS | DATE |
|-----|---------------|------------|
| A | First Drawn | 10/06/2011 |
| - | - | - |
| - | - | - |
| - | - | - |
| - | - | - |
| - | - | - |

Drawn:
 P. Wood-Statesbury

Date:
 10/06/2011

Scale (A4): 1:2

Part Name:
 SS30 Inline Shower

Drawing No.
 1021-1

Sheet:
 3 of 10

Wall mount assembly
(cap removed)

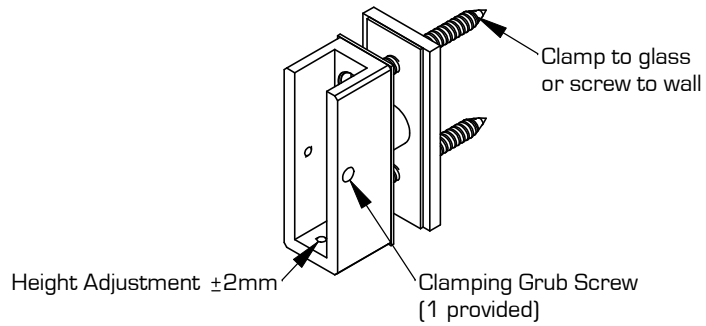

SS30 Roller

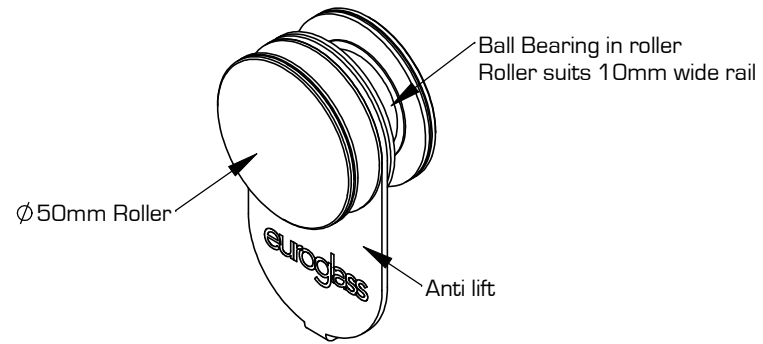

Stop/ Mount Assembly

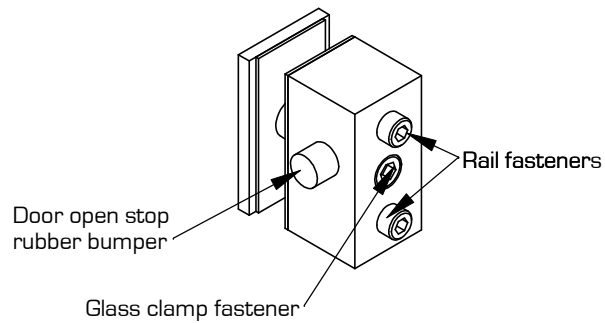

© COPYRIGHT 2010

This drawing and or specification is the property of Euroglass Systems Ltd - and must be returned to them on request. Unauthorised use may result in Legal Action. Its contents must not be made public, nor copied, nor used directly or indirectly in any way.

Tolerance (Unless otherwise stated)

Dec place 0.00 ±0.1mm
0.0 ±0.2mm
0 ±0.5mm
Angular ±0.5°

Special Instructions:

Remove all burrs & sharp edges.



65 Carr Road
Mt Roskill
Auckland
New Zealand
+694 624-1180

DRAWN IN
THIRD ANGLE
PROJECTION

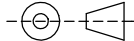

Material: See component drawings

Finish: See component drawings

| REV | MODIFICATIONS | DATE |
|-----|---------------|------------|
| A | First Drawn | 10/06/2011 |
| - | - | - |
| - | - | - |
| - | - | - |
| - | - | - |
| - | - | - |

Drawn:
P. Wood-Statesbury

Date:
10/06/2011

Scale (A4): 1:5

Part Name:
SS30 Inline Shower

Drawing No.
1021-1

Sheet:
4 of 10

Wall mount assembly
(cap removed)

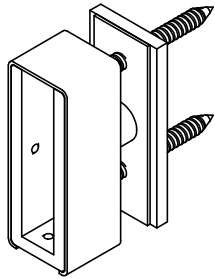

SS30 Roller

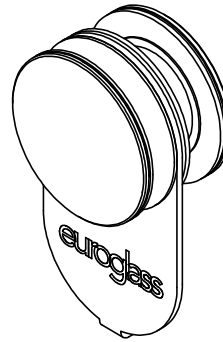

Stop/ Mount Assembly

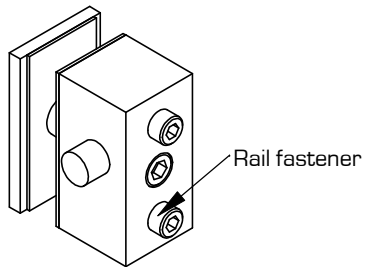

Rail fastener

© COPYRIGHT 2010

This drawing and or specification is the property of Euroglass Systems Ltd - and must be returned to them on request. Unauthorised use may result in Legal Action. Its contents must not be made public, nor copied, nor used directly or indirectly in any way.

Tolerance (Unless otherwise stated)

Dec place 0.00 ±0.1mm
0.0 ±0.2mm
0 ±0.5mm
Angular ±0.5°

Special Instructions:

Remove all burrs & sharp edges.



65 Carr Road
Mt Roskill
Auckland
New Zealand
+694 624-1180

DRAWN IN
THIRD ANGLE
PROJECTION

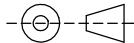

Material: See component drawings

Finish: See component drawings

| REV | MODIFICATIONS | DATE |
|-----|---------------|------------|
| A | First Drawn | 10/06/2011 |
| - | - | - |
| - | - | - |
| - | - | - |
| - | - | - |
| - | - | - |

Drawn:
P. Wood-Statesbury

Date:
10/06/2011

Scale (A4): 1:5

Part Name:
SS30 Inline Shower

Drawing No.
1021-1

Sheet:
5 of 10

Wall mount assembly
(cap removed)

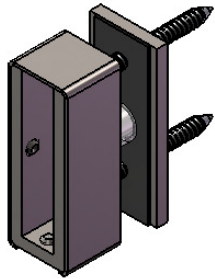

SS30 Roller



Stop/ Mount Assembly

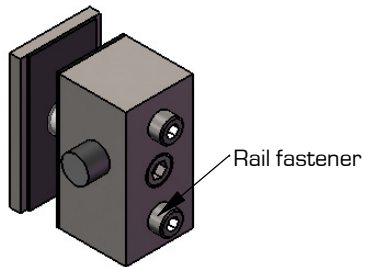

© COPYRIGHT 2010

This drawing and or specification is the property of Euroglass Systems Ltd - and must be returned to them on request. Unauthorised use may result in Legal Action. Its contents must not be made public, nor copied, nor used directly or indirectly in any way.

Tolerance (Unless otherwise stated)

Dec place 0.00 ±0.1mm
0.0 ±0.2mm
0 ±0.5mm
Angular ±0.5°

Special Instructions:

Remove all burrs & sharp edges.



65 Carr Road
Mt Roskill
Auckland
New Zealand
+694 624-1180

DRAWN IN
THIRD ANGLE
PROJECTION

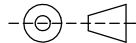

Material: See component drawings

Finish: See component drawings

| REV | MODIFICATIONS | DATE |
|-----|---------------|------------|
| A | First Drawn | 10/06/2011 |
| - | - | - |
| - | - | - |
| - | - | - |
| - | - | - |
| - | - | - |

Drawn:
P. Wood-Statesbury

Date:
10/06/2011

Scale (A4): 1:5

Part Name:
SS30 Inline Shower

Drawing No.
1021-1

Sheet:
6 of 10

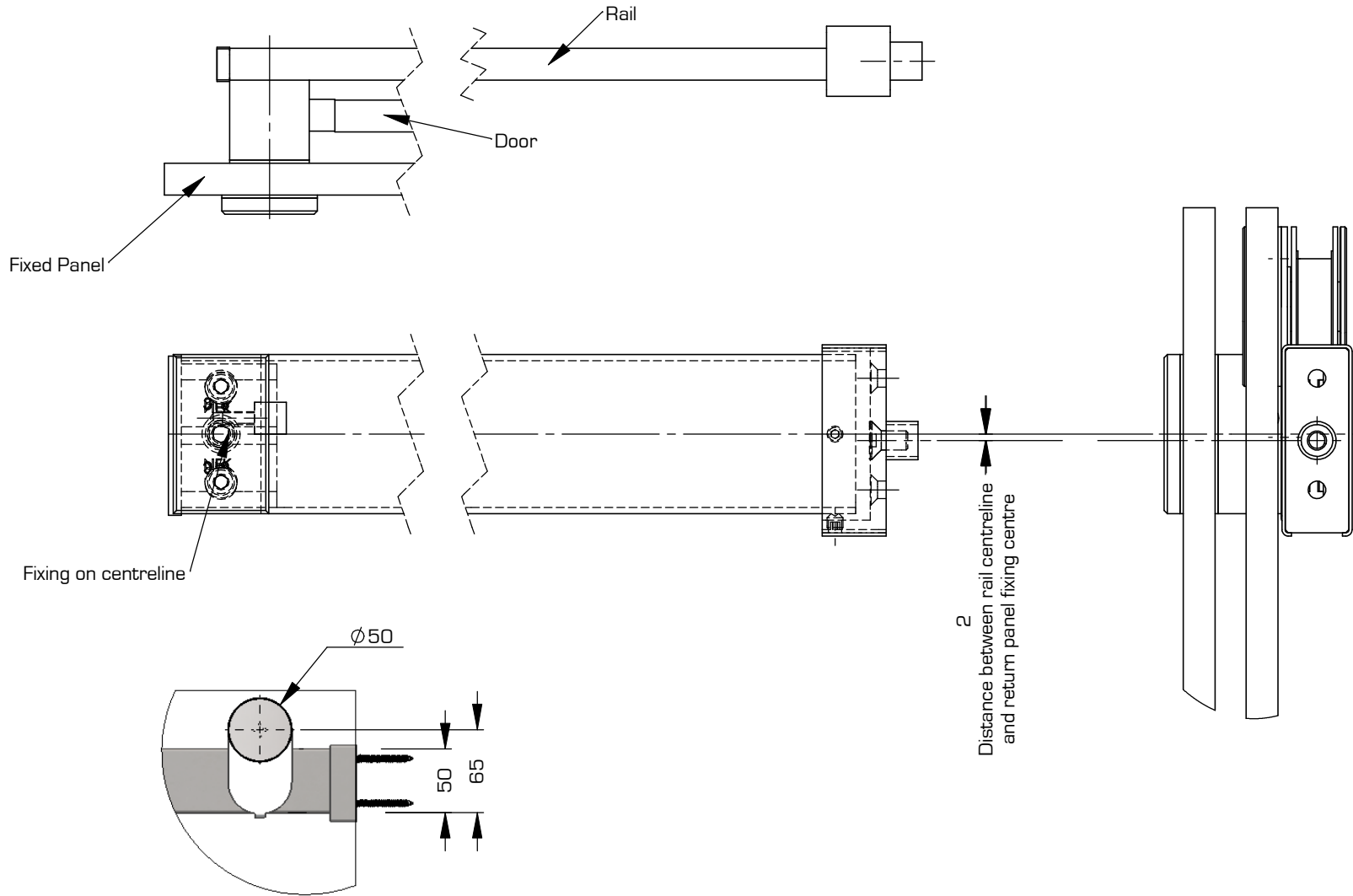

© COPYRIGHT 2010

This drawing and or specification is the property of Euroglass Systems Ltd - and must be returned to them on request. Unauthorised use may result in Legal Action. Its contents must not be made public, nor copied, nor used directly or indirectly in any way.

Tolerance (Unless otherwise stated)

Dec place 0.00 ±0.1mm
 0.0 ±0.2mm
 0 ±0.5mm
 Angular: ±0.5°

Special Instructions:

Remove all burrs & sharp edges.



65 Carr Road
 Mt Roskill
 Auckland
 New Zealand
 +694 624-1180

DRAWN IN
 THIRD ANGLE
 PROJECTION

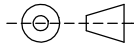

Material: See component drawings

Finish: See component drawings

| REV | MODIFICATIONS | DATE |
|-----|---------------|------------|
| A | First Drawn | 10/06/2011 |
| - | - | - |
| - | - | - |
| - | - | - |
| - | - | - |

Drawn: P. Wood-Statesbury

Date: 10/06/2011

Scale (A4): 1:20

Part Name:
SS30 Inline Shower

Drawing No.
1021-1

Sheet:
 7 of 10

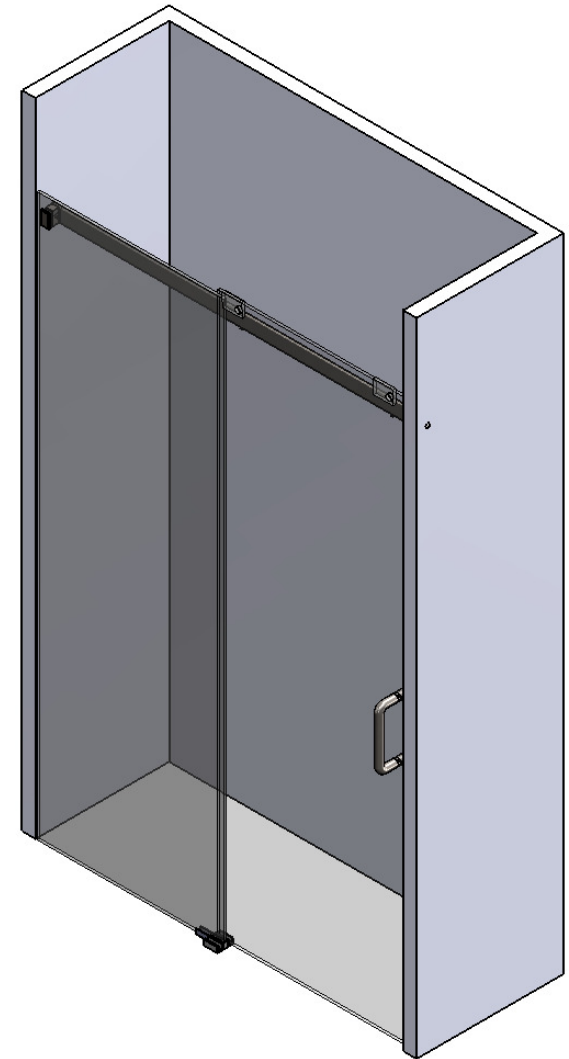
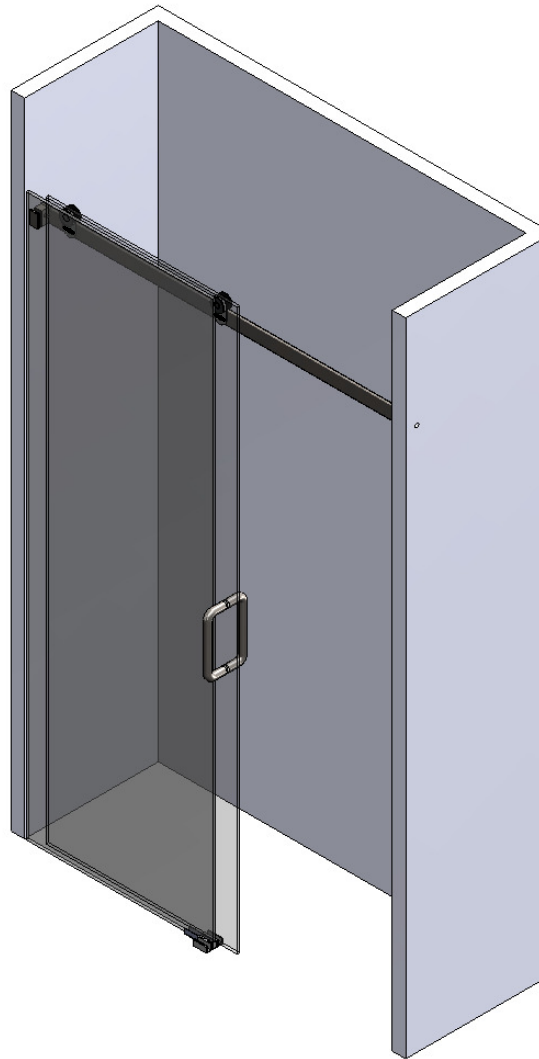
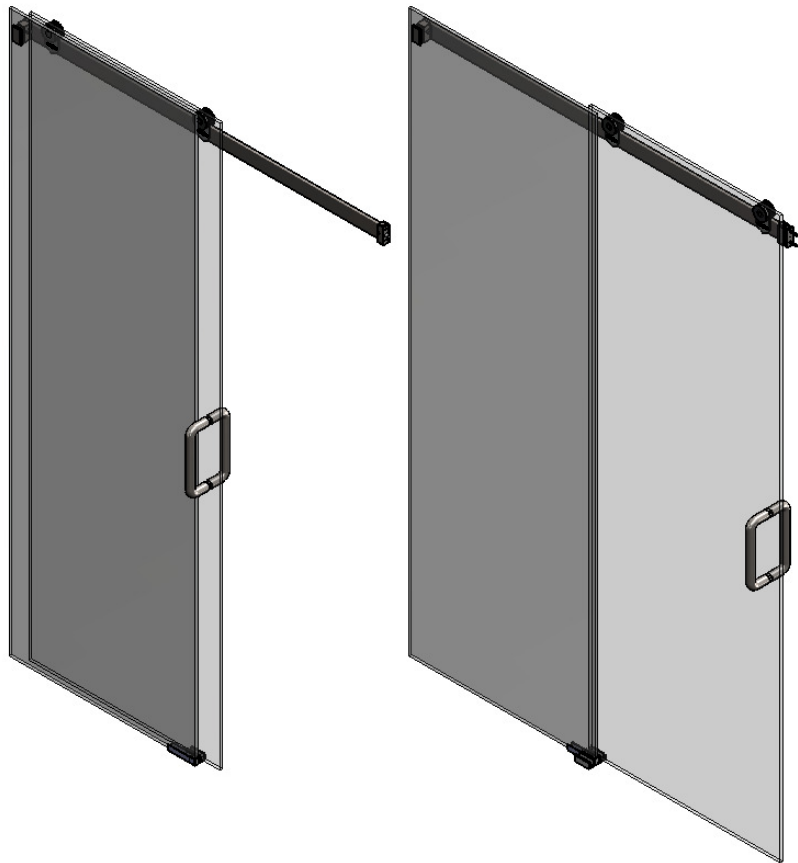

© COPYRIGHT 2010

This drawing and or specification is the property of Euroglass Systems Ltd - and must be returned to them on request. Unauthorised use may result in Legal Action. Its contents must not be made public, nor copied, nor used directly or indirectly in any way.

Tolerance [Unless otherwise stated]

Dec place 0.00 ±0.1mm
 0.0 ±0.2mm
 0 ±0.5mm
 Angular: ±0.5°

Special Instructions:

Remove all burrs & sharp edges.



65 Carr Road
 Mt Roskill
 Auckland
 New Zealand
 +694 624-1180

DRAWN IN
 THIRD ANGLE
 PROJECTION

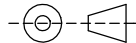

Material: See component drawings

Finish: See component drawings

| REV | MODIFICATIONS | DATE |
|-----|---------------|------------|
| A | First Drawn | 10/06/2011 |
| - | - | - |
| - | - | - |
| - | - | - |
| - | - | - |
| - | - | - |

Drawn:
 P. Wood-Statesbury

Date:
 10/06/2011

Scale (A4): 1:20

Part Name:
 SS30 Inline Shower

Drawing No.
 1021-1

Sheet:
 8 of 10

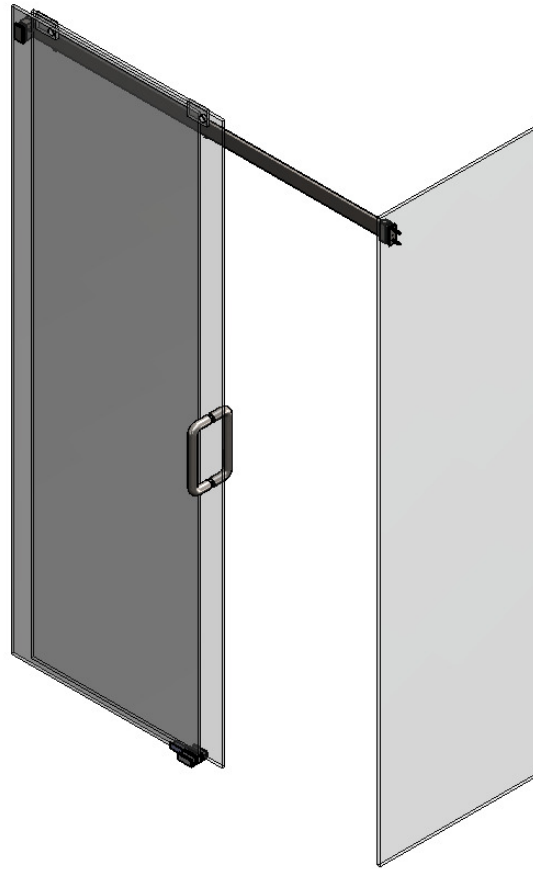
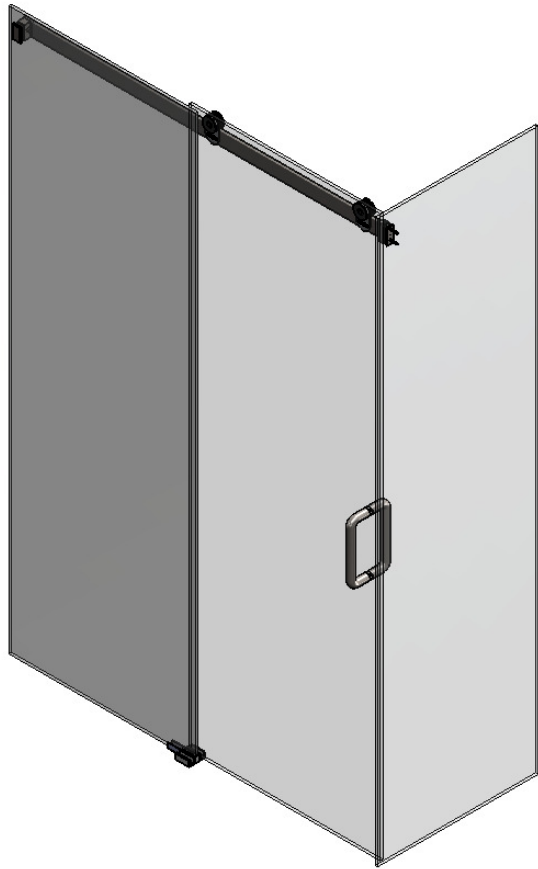

© COPYRIGHT 2010

This drawing and or specification is the property of Euroglass Systems Ltd - and must be returned to them on request. Unauthorised use may result in Legal Action. Its contents must not be made public, nor copied, nor used directly or indirectly in any way.

Tolerance [Unless otherwise stated]

Dec place 0.00 ±0.1mm
 0.0 ±0.2mm
 0 ±0.5mm
 Angular ±0.5°

Special Instructions:

Remove all burrs & sharp edges.



65 Carr Road
 Mt Roskill
 Auckland
 New Zealand
 +694 624-1180

DRAWN IN
 THIRD ANGLE
 PROJECTION

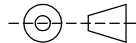

Material: See component drawings

Finish: See component drawings

| REV | MODIFICATIONS | DATE |
|-----|---------------|------------|
| A | First Drawn | 10/06/2011 |
| - | - | - |
| - | - | - |
| - | - | - |
| - | - | - |
| - | - | - |

Drawn:
 P. Wood-Statesbury

Date:
 10/06/2011

Scale (A4): 1:20

Part Name:
 SS30 Inline Shower

Drawing No.
 1021-1

Sheet:
 9 of 10

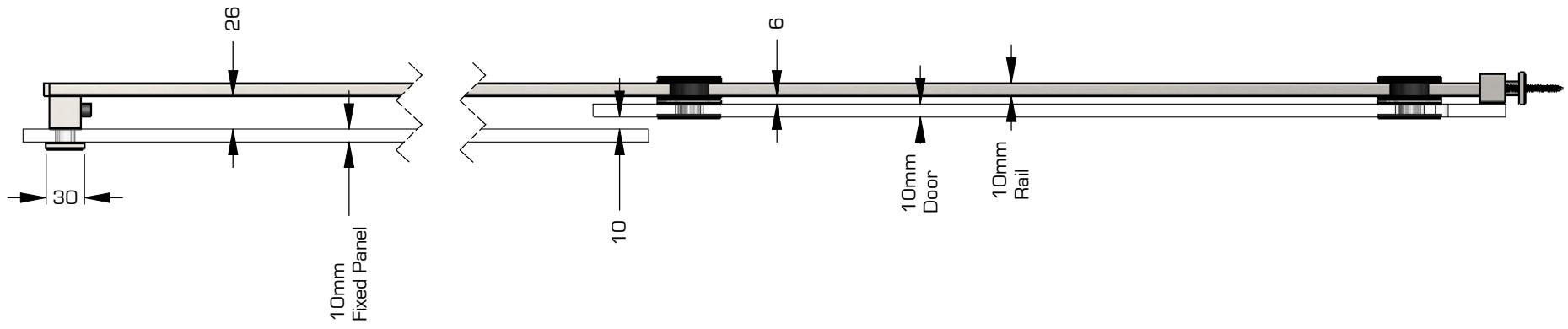

© COPYRIGHT 2010

This drawing and or specification is the property of Euroglass Systems Ltd - and must be returned to them on request. Unauthorised use may result in Legal Action. Its contents must not be made public, nor copied, nor used directly or indirectly in any way.

Tolerance (Unless otherwise stated)

Dec place 0.00 ±0.1mm
 0.0 ±0.2mm
 0 ±0.5mm
 Angular ±0.5°

Special Instructions:

Remove all burrs & sharp edges.



65 Carr Road
 Mt Roskill
 Auckland
 New Zealand
 +694 624-1180

DRAWN IN
 THIRD ANGLE
 PROJECTION

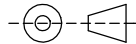

Material: See component drawings

Finish: See component drawings

| REV | MODIFICATIONS | DATE |
|-----|---------------|------------|
| A | First Drawn | 10/06/2011 |
| - | - | - |
| - | - | - |
| - | - | - |
| - | - | - |
| - | - | - |

Drawn:
 P. Wood-Statesbury

Date:
 10/06/2011

Scale (A4): 1:5

Part Name:
 SS30 Inline Shower

Drawing No.
 1021-1

Sheet:
 10 of 10